

BARLOW TYRIE

quality since 1920



BarlowTyrie



1MOA 1MO 1MO15 2MO15

contents

heritage	4
materials	6
teak collection	8
stainless steel collection	68
aluminium collection	102
woven collection	112
parasols & pavilions	156
specifications	170
materials selection	199
covers	206
inscriptions	207
product care	208
faqs	209



heritage

Barlow Tyrie is associated the world over with outdoor leisure furniture that strikes the highest notes in quality and style.

Since 1920, we have remained a family business that specializes in the manufacture of teak furniture to which we have now added furniture in hand-woven synthetic fibre, stainless steel and aluminium.

The pages of this catalogue present our widest ever choice of contemporary and traditional designs for the outdoor room. Our designers have combined pleasing designs with ergonomic performance to create furniture that opens life outdoors to a world of stylish possibilities.

armchairs • seats • benches • dining tables • tree seats • sun loungers • folding chairs • coffee tables

Through our commitment to produce the world's finest outdoor leisure furniture, we remain at the forefront of this rapidly changing industry and continue to demonstrate the best in British design and manufacturing expertise.

Thank you for choosing Barlow Tyrie and be assured that our customer service and after care match the excellence of our furniture.

We proudly welcome you into the elite group of owners of our furniture and look forward to being of service to you.

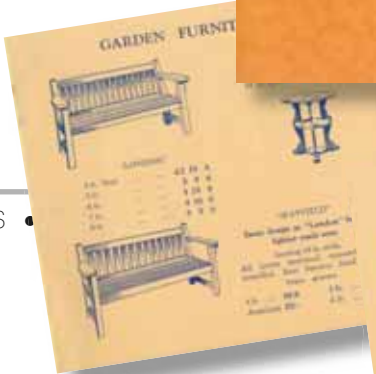

tables • corner • chests • cus

materials



Barlow Tyrie uses first grade plantation grown teakwood (*Tectona Grandis*), obtained from the most reputable, legal source in Indonesia.

With time, teak acquires a silver grey patina that complements any outdoor setting.

The high oil content of the teakwood used in our furniture enables it to withstand the harshest weather conditions with a minimum of maintenance. Teak is very stable and resistant to rot, which has made it the first choice for marine and outdoor use over the centuries.

We use two grades of stainless steel; 316 Grade, commonly known as 'marine grade' and 304 Grade, more commonly used for garden furniture.

Both 316 and 304 are hardwearing and suitable for use in inland locations whilst 316 is for use in coastal areas, marine and heavily chlorinated environments, where oxidation could be a problem.

You should note that all outdoor furniture, including stainless steel, requires some maintenance.

If you have any questions or concerns about the grade that is best for your area, then please contact your supplier or our customer service department.

For our aluminium furniture, we use 'virgin aluminium,' which means it is not reclaimed and is stronger and longer lasting as a consequence.

We chemically clean the aluminium and then powder-coat it to prevent oxidation and to ensure it gives long service with the minimum of maintenance.



We introduced our comprehensive woven ranges in recent years, since then they have become very popular.

We use the finest synthetic material that is hand-woven over a powder coated aluminium frame to produce splendid furniture that is strong, colour fast and entirely resistant to sun and rain.



Textilene® is woven from a PVC coated polyester, non-stretch yarn, which is strong and mildew resistant.

We use Textilene® for the fabric slings on our teak, stainless steel and aluminium furniture to incorporate colour, comfort and weather resistance.



Our range of luxury cushions adds that personal touch to your furniture. We use Sunbrella® fabric, made from 100% solution dyed acrylic fibre that is colourfast and resistant to mildew.

Our cushions are available in a range of outstanding solid colours and stripes.

The best furniture deserves only the very best cushions.



teak







1ADA p.172
1ADFR p.172
2AD p.172



adirondack





Quadri Grey



Lead Chiné

Reversible Slip Over Armchair Cushion
in Quadri Grey and Lead Chiné.
Ref. 800087.9998

1APA p.172

1APA p.172
2APX39 p.31 p.172

apex



1ASC p.172
1AS p.172
1ASF5 p.172
2AS11 p.173

ascot

1ASC p.172
2AR18 p.184





ascot



1ASR p.172
2ARX28 p.184





Tim Fenby is an award-winning British designer, who has worked extensively around the world. He is renowned for bringing a unique understanding of global markets and trends to his designs, which can be seen today in quality independent retailers and major department stores.

The Avon collection is a fusion of soft retro curves from the 40's and 50's with the clean, simple lines of today. It is a contemporary teak dining range that presents Barlow Tyrie's distinguished craftsmanship and expertise in making beautifully sculpted, quality teak furniture. The understated appeal of Tim Fenby's latest work, will ensure its enjoyment outdoors for many years to come.

1AVA p.173
2AV20 p.173

1AVA p.173
2AV20 p.173



1AVA p.173
2AVX26 p.173

avon







1CAS p.173



1CO p.174

commodore





1HADA p.176
1HAO p.176

haven

1HADA p.176
1HADMC p.177
1HADML p.177
1HADMR p.177
1HADMM p.177
1HAO p.176





1HOF.504 p.178

horizon





1HOAS.T p.177

horizon

1HOAS.500 p.177
2APX39 p.172







1HOR.504 p.178





1HOL.505 p.177
1HOL.502 p.177
1HOL.504 p.177
1HOL.500 p.177

1HOL.500 p.177
1LSS.500 p.177

horizon





11A p.178



linear



11A p.178
2HOC18 p.178





1LID2 p.179
2LIL07 p.179



1LIDA p.179
1LID3 p.179
2LILS07 p.179



linear



1MOA p.180
2COL p.186

monaco

1MOA p.180
1MO p.180
2WIX23 p.185
1MO15 p.181







1MOCF p.180

1MOF p.180
1MOCF p.180
2WIC15 p.185

monaco



1MOL p.181

monaco

mission

1MIA p.180
4SO35C.308 p.166







1FEA p.174

1FEA p.174
2BA13 p.184
4VE30C.306 p.164

felsted



1SA.201 p.182
1SAT p.182

safari







1GL15 p.175

1GLA p.175
1FEFS p.175
2AR24 p.184

glenham





glenham





1LOA p.180
2COL p.186
3ST p.186





1RO18 p.182



ISI p.183

sissinghurst





1WA15 p.183

waveney



accessories



storage chests

3SC15 p.186



reims

3RE p.186



crichton

2CR p.186



serving tray

3ST p.186

accessories



caisse versailles

3CV45 p.186



1NER p.182

newport



wimbledon

1W12 p.183
1W15 p.183
1W18 p.183

stainless steel





1EQ.T p.187
1EQA.T p.187
2EQC10 p.189

equinox

1EQ.T p.187
1EQA.T p.187
1EQ13 p.187
2EQ15 p.188
2EQL06 p.188





equinox



1EQA.504 p.187
2EQ10 p.188



1EQA.505 p.187
2EQC07 p.189

equinox

1EQA.500 p.187
2EQC15S p.189





1EQA.01.500 p.187
2EQC18.700 p.190

equinox

1EQA.01.500 p.187
2EQ20.700 p.190







1EQL.T p.188



equinox



1EQL.504 p.187
2EQLT p.188
4SI25C.306 p.164





1EQHC.T p.187
1EQH.T p.187
2EQS p.188

1EQHS.T p.187
1EQHC.T p.187

equinox



1EQD3 p.191
1EQD2 p.191
2EQL06 p.188

equinox





1MEA.01.500 p.191
2EQC18S p.189

mercury

1MEA.504 p.191
2EQX23 p.189







1MEA.500 p.191



mercury



1MEA.01.500 p.191
2EQC18.700 p.190





1MEDM (x3) p.192
1MEDC p.192



1MEDM (x2) p.192
1MEDC p.192
1MEDO p.191
1MEDAC (x2) p.191
2EQL04 (x2) p.188



mercury





1. Scratchproof work surface
2. Cutlery and accessories drawers
3. Serving trays
4. Condiment racks
5. Positioning wheels

mercury



1QUA.504 p.192
2QU20.700 p.192

quattro

1QUA.01.500 p.192
2QU10.700 p.192







1QUL.504 p.192

1QUL.504 p.192
2QULT p.192
1LSS.504 p.192

quattro

aluminium









1AUA.01.500 p.193



1AUA.01.500 p.193
2AU09.01 p.193

aura

1AUA.02.505 p.193
2AU15.02 p.193





1AUHC.02.505 p.193
2AUH14.02 p.193



aura



1AUDA.01.500 p.193

aura

1AUDA.01.500 p.193
1AUFS.01.500 p.193



woven









605100 p.195



605351 p.195
605350 p.196

nevada

605351 p.195
605350 p.196
605353 p.195
2COL p.186





605470 p.196

nevada







606661 p.198



Designed for Barlow Tyrie by Laura Kirar, the New York based founder and creative director of LAURA KIRAR Design.

The new range consists of a deep seating group, dining group, sun lounger and the Tête-à-tête day-bed, all available in two colours, Java and Driftwood.

Drawing inspiration from Japanese basket weaving, Laura has created a unique triaxial weave pattern that sets a new design bench mark for the outdoor industry.

With sumptuous curves and generous proportions the Kirar Collection delivers both comfort and beauty.

The design has subtly married traditional weave techniques with modern aesthetics to create, what will surely become, a contemporary classic.

LAURA KIRAR



LAURA KIRAR







606361 p.198
606360 p.198

LAURA KIRAR

606361 p.198
606661 p.198



606361 p.198
606363 p.198
606661 p.198



LAURA KIRAR



606100 p.197

LAURA KIRAR





606100 p.197
606524 p.198



LAURA KIRAR





606110 p.197

LAURA KIRAR



606110 p.197
606534 p.198



LAURA KIRAR



LAURA KIRAR







Vladimir Kagan is one of today's most enduring designers of modern furniture with a career that has spanned over sixty years.

He is recognised as one of the most important furniture designers of the 20th Century, his early designs from the forties, fifties and sixties have become icons of Modernity and reference points for all designers.

His creativity has been responsible for inspiring a whole generation of designers. Kagan designs are avidly collected by connoisseurs and museums world wide.

Barlow Tyrie is proud of this exceptional range of furniture which is the result of close collaboration with Vladimir Kagan.

601355 p.194
601350 p.194

601361 p.194
601360 p.194
601364 p.194
601365 p.194
601366 p.194
601367 (x3) p.194
601660 p.194
603470 (x2) p.196

arizona



601650 p.194
601354 p.194
601355 p.194
601356 p.194
601357 (x2) p.194



arizona



601361 p.194

arizona

- 601361 (x2) p.194
- 601360 p.194
- 601364 p.194
- 601365 p.194
- 601367 (x2) p.194
- 601366 p.194
- 601662 p.194
- 601661 p.194







602700 p.195



602361 p.195
602660 p.195

dune

602362 p.195
602660 p.195







603100 p.196
603524 p.197



603100 (x2) p.197
603171 (x6) p.196
603565 p.197



savannah



603351 p.196

savannah

- 603351 p.196
- 603350 p.196
- 603352 p.196
- 603353 p.196
- 603651 p.197
- 603670 p.197







603470 p.196

603470 p.196
603700 p.196
4VE30C.306 p.164

savannah

pavilions & parasols

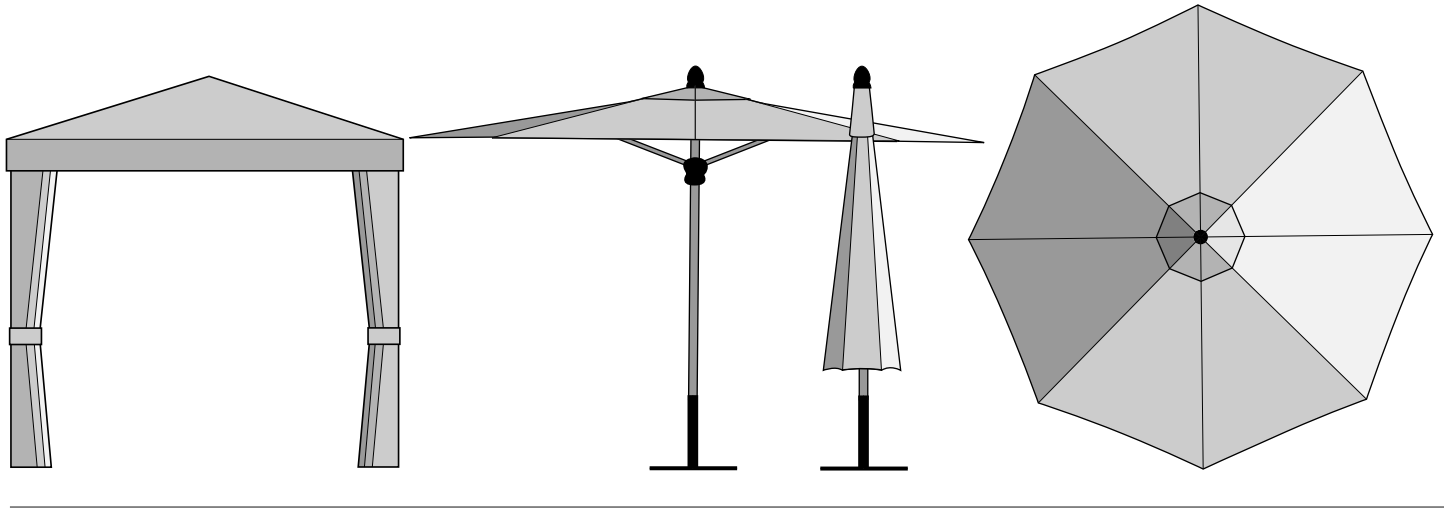

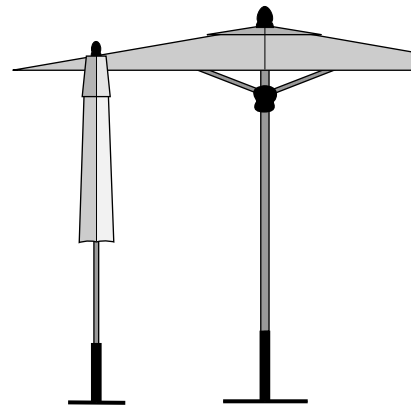
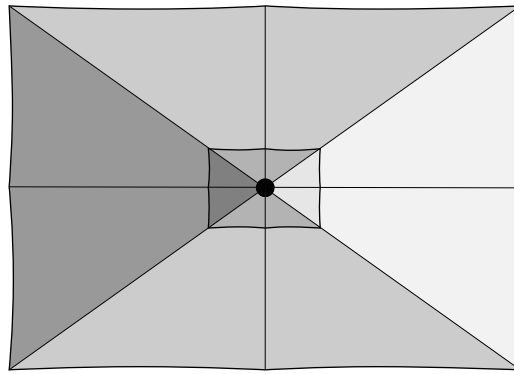
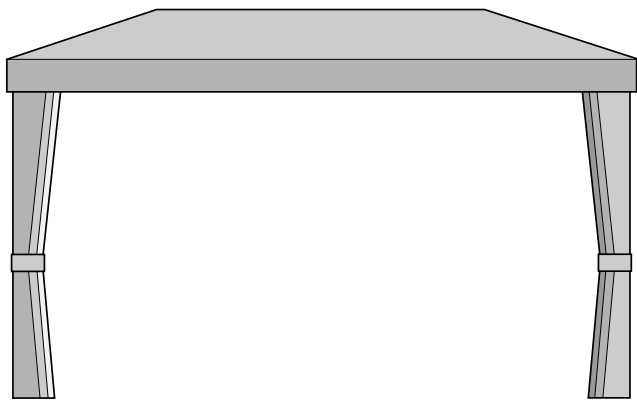

Our parasol canopy fabric is made from 100% solution-dyed acrylic yarn. The colour locks deep inside the yarn to give excellent resistance to the fading often caused by sunlight and cleaning.

The fabric has a stain repellent applied to make cleaning easier, which you should re-apply after cleaning.

We recommend that you clean the canopy regularly to prevent the accumulation of dirt in the fabric, which can encourage the growth of mildew.

All Barlow Tyrie parasols will close over our standard height dining tables that have parasol holes, except our High Dining Tables.

Pavilions are permanent structures made from the highest quality heavy duty aluminium, with the roof and full curtains from Sunbrella® fabric, which is woven from 100% solution-dyed acrylic yarn.

For areas which experience heavy snow fall, do not allow snow or ice to accumulate on the Pavilion roof as this may cause structural damage.





pavilions





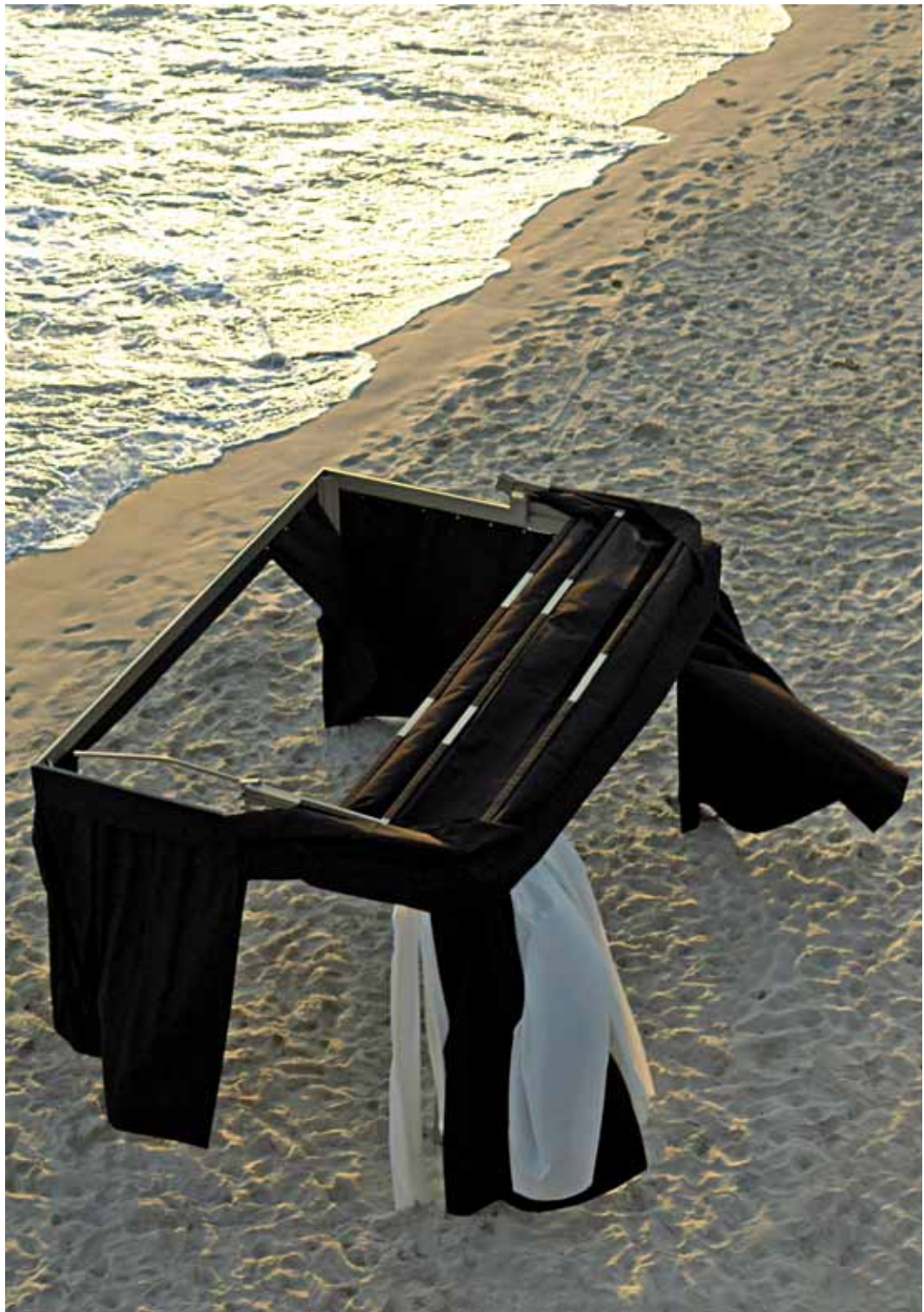

9111210.4781 p.162
Cabrio

- 9011215.4642 p.162
- 601350 p.194
- 601351 p.194
- 601354 p.194
- 601355 p.194
- 601356 p.194
- 601357 x2 p.194
- 601651 p.194

pavilions

pavilions

Fixed Roof
9011210

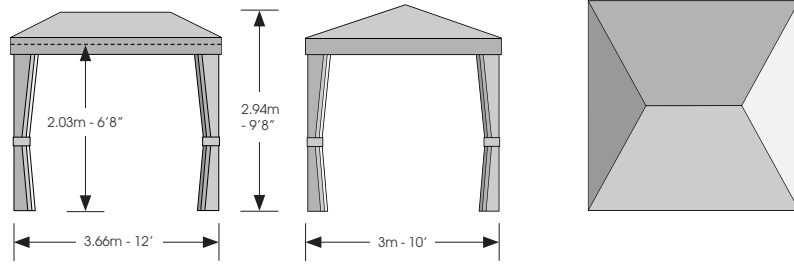

Anchoring the Pavilion

For safety, Pavilions should always be securely fastened to the ground.

See assembly instructions for details of various securing methods.

The Permo Lock anchoring system is the recommended method that offers a strong permanent solution for anchoring your Pavilion and to protect it against the wind.

913012 Permo® Lock Anchoring System

Other ground fixing accessories available
913010 For Wood Floors
913011 For Stone Floors

Fixed Roof
9011215

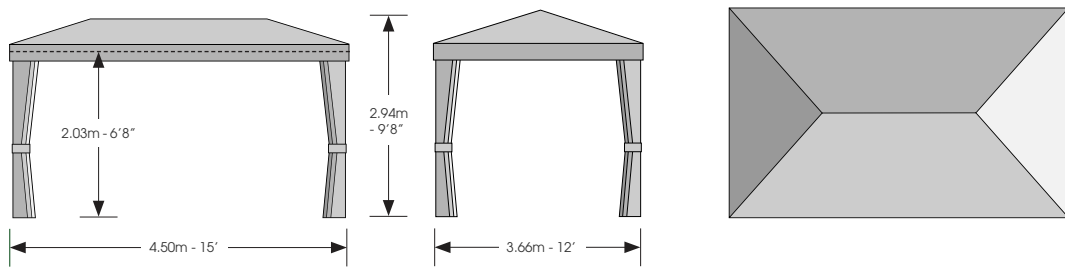

Fixed Roof
9011220

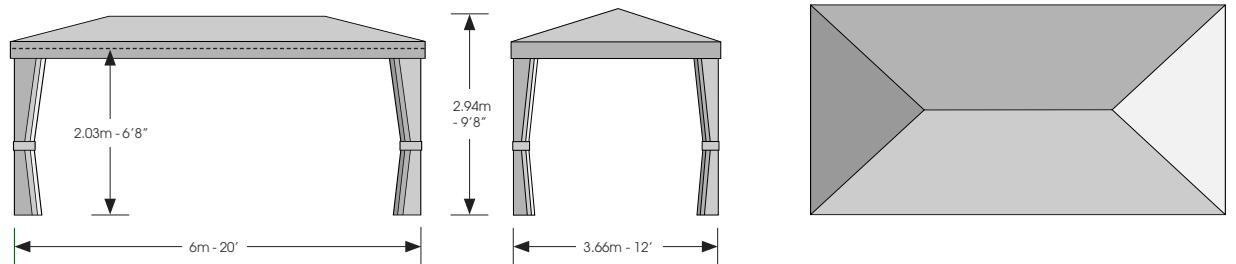

Cabrio
Opening Roof
9111210

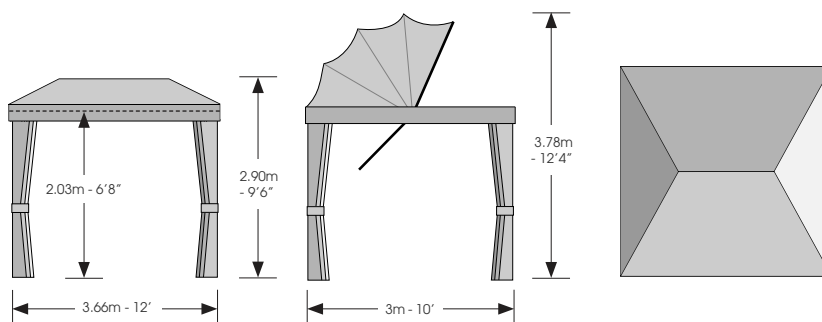

Colour Selector - Suggested Combinations

For colour reference please see page 202

The frame is made from heavy duty aluminium with the roof and full curtains from Sunbrella® fabric, which is woven using 100% solution dyed acrylic fibre that does not fade when exposed to strong sunlight.

.1275 Stone .4781 Chocolate 4642 Oyster .0001 White .0002 Silver

Fixed Roof								
Frame 3.66 x 3.00m - 12' x 10'	required		9011210		9011210		9011210	
Sunbrella Roof	required		9021210.1275	Stone	9021210.4781	Chocolate	9021210.4642	Oyster
Corner Dressing	required		909010.1275	Stone	909010.4642	Oyster	909010.4642	Oyster
Corner Ties x4	required		909050.1275	Stone	909050.4781	Chocolate	909050.4642	Oyster
Mesh Curtains x4	optional		9041210.4651	Silver	9041210.4781	Chocolate	9041210.4604	White
Sunbrella Curtains x4	optional		9031210.1275	Stone	9031210.4781	Chocolate	9031210.4642	Oyster
Sheer Panels x8	optional		909080.0002	Silver	909080.0001	White	909080.0001	White
Fixed Roof								
Frame 3.66 x 4.50m - 12' x 15'	required		9011215		9011215		9011215	
Sunbrella Roof	required		9021215.1275	Stone	9021215.4781	Chocolate	9021215.4642	Oyster
Corner Dressing	required		909020.1275	Stone	909020.4642	Oyster	909020.4642	Oyster
Corner Ties x4	required		909050.1275	Stone	909050.4781	Chocolate	909050.4642	Oyster
Mesh Curtains x4	optional		9041215.4651	Silver	9041215.4781	Chocolate	9041215.4604	White
Sunbrella Curtains x4	optional		9031215.1275	Stone	9031215.4781	Chocolate	9031215.4642	Oyster
Sheer Panels x8	optional		909080.0002	Silver	909080.0001	White	909080.0001	White
Fixed Roof								
Frame 3.66 x 6.00m - 12' x 20'	required		9011220		9011220		9011220	
Sunbrella Roof	required		9021220.1275	Stone	9021220.4781	Chocolate	9021220.4642	Oyster
Corner Dressing	required		909020.1275	Stone	909020.4642	Oyster	909020.4642	Oyster
Corner Ties x4	required		909050.1275	Stone	909050.4781	Chocolate	909050.4642	Oyster
Mesh Curtains x4	optional		9041220.4651	Silver	9041220.4781	Chocolate	9041220.4604	White
Sunbrella Curtains x4	optional		9031220.1275	Stone	9031220.4781	Chocolate	9031220.4642	Oyster
Sheer Panels x8	optional		909080.0002	Silver	909080.0001	White	909080.0001	White
Cabrio - Opening Roof								
Frame 3.66 x 3.00m - 12' x 10'	required		9111210		9111210		9111210	
Sunbrella Roof	required		9121210.1275	Stone	9121210.4781	Chocolate	9121210.4642	Oyster
Corner Dressing	required		909020.1275	Stone	909020.4642	Oyster	909020.4642	Oyster
Corner Ties x4	required		909050.1275	Stone	909050.4781	Chocolate	909050.4642	Oyster
Mesh Curtains x4	optional		9041210.4651	Silver	9041210.4781	Chocolate	9041210.4604	White
Sunbrella Curtains x4	optional		9031210.1275	Stone	9031210.4781	Chocolate	9031210.4642	Oyster
Sheer Panels x8	optional		909080.0002	Silver	909080.0001	White	909080.0001	White

If Sunbrella® Curtains are chosen then Corner Dressing and Corner Ties are not required.

Only one set of curtains can be used on the 12 x 10 Pavilion whilst both sets can be used on the 12 x 15 and 12 x 20 Pavilions

features



**Sunbrella®
Curtains**
(optional)

Curtains that give maximum protection, complete privacy and can be fully closed with a zip.



Sheer Panels
(optional)

A perfect way to add ambience to your entertaining, a sheer, light screen that adds movement in the breeze or can be used to shield the sun.



Mesh Curtains
(optional)

Provides a see through shield from the elements and can be fully closed with a zip. The curtains may be drawn on just one or two sides to provide shelter from the wind or strong sunshine.



**Heating and
Lighting**
(optional)

This infrared short-wave radiant heater instantly provides comfortable heat as soon as it is switched on. The integrated lighting units may be rotated 180°.

(This design is not available in the USA)



**Corner
Dressing**

Dresses the four corner posts but are not required if the Pavilion has Sunbrella® curtains.

Corner Ties

Used to tie back the Corner Dressing or curtains if fitted



Cabrio Roof
(optional)

An optional folding Cabrio roof, which can be opened to allow in the sun; available on the 3.66 x 3.00m - 12' x 10' pavilion only.

parasols

siena 4SI25C

With chrome fittings.
Suitable for the following tables:

- Arundel 2AR09
- Aura 2AU09
- Ascot 2AS11
- Balmoral 2BA11
- Eclipse 2ECC12
- Edinburgh 2ED09
- 2EDH09
- Equinox 2EQ09.700
- 2EQ10
- 2EQC07
- 2EQC10
- 2EQCH07
- 2EQCH10
- Haven 2HASC10
- 2HACC10
- Meizo 2ME09T
- Savannah 603522
- 603524

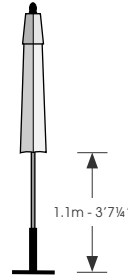
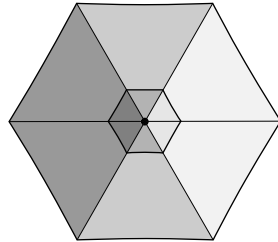
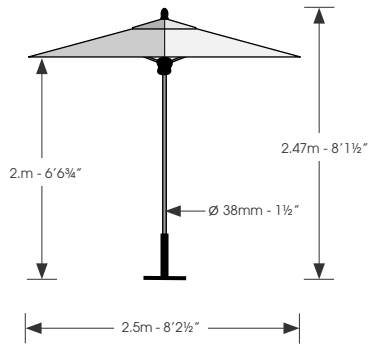

Optional Extras



Parasol Pole Reducer Ring
To remove movement between table top and pole
Brass - 4PR.38
Stainless Steel - 4PRSS.38



Parasol Base Required
Standard - 4PBS
Free Standing - 4PBF + 4PBFTS

verona 4VE30C

With chrome fittings.
Suitable for the following tables:

- Ascot 2AS13
- Balmoral 2BA13
- Drummond 2DR15
- Edinburgh 2EDH09
- Equinox 2EQ15.700
- Haven 2HASC10
- 2HACC10
- Horizon 2HOC15
- Windsor 2WI12
- 2WIC15

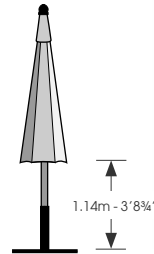
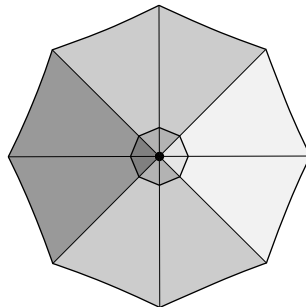
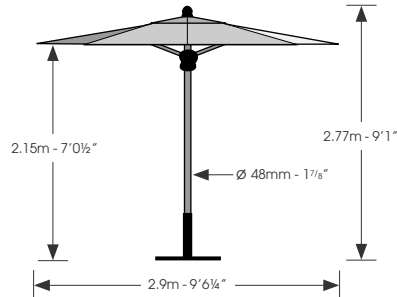

Optional Extras



Parasol Pole Reducer Ring
To remove movement between table top and pole
Brass - 4PR.48
Stainless Steel - 4PRSS.48



Parasol Base Required
Standard - 4PBM
Free Standing - 4PBF + 4PBFTM

verona 4VE30R

With chrome fittings.
Suitable for the following tables:

- Arundel 2AR13
- 2AR18
- Aura 2AU15
- 2AU20
- Equinox 2EQ15
- 2EQ20.700
- Meizo 2ME15T
- Monaco 2MO15
- Stirling 2ST20
- Windsor 2WI15

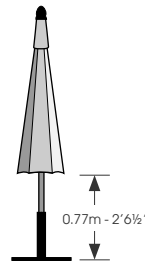
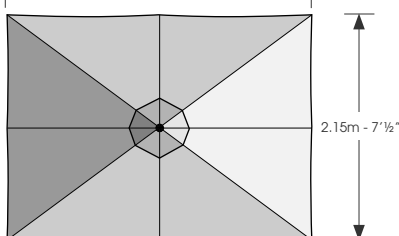
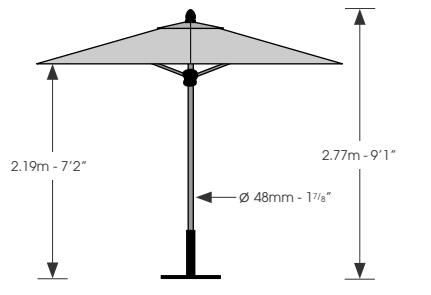

Optional Extras



Parasol Pole Reducer Ring
To remove movement between table top and pole
Brass - 4PR.48
Stainless Steel - 4PRSS.48



Parasol Base Required
Standard - 4PBM
Free Standing - 4PBF + 4PBFTM

parasols

milano 4MI35C

With brass fittings. Suitable for the following tables:

Drummond
2DR15
2DR18
Horizon
2HOC15
2HOC18

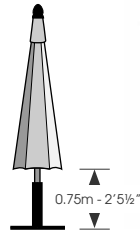
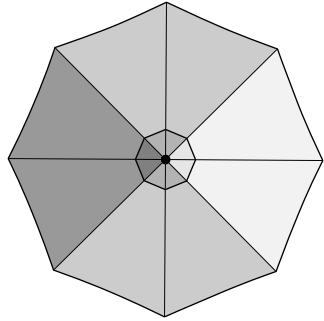
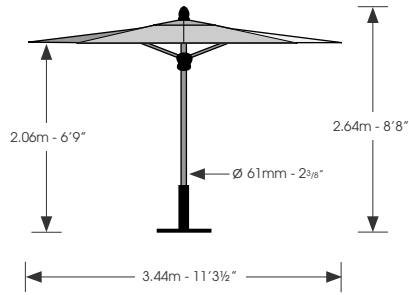

Optional Extras



Parasol Pole Reducer Ring
To remove movement between table top and pole
Brass - 4PR.61
Stainless Steel - 4PRSS.61



Parasol Base Required
Standard - 4PBL
Free Standing - 4PBFP + 4PBFTL

milano 4MI40C

With brass fittings. Suitable for the following tables:

Drummond
2DR18
Horizon
2HOC18

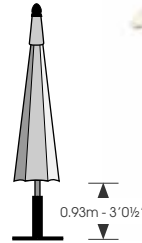
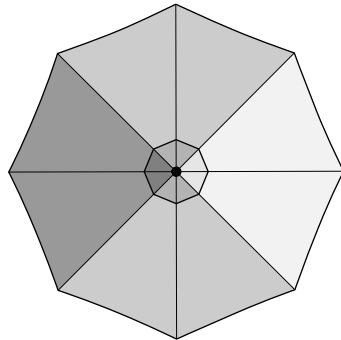
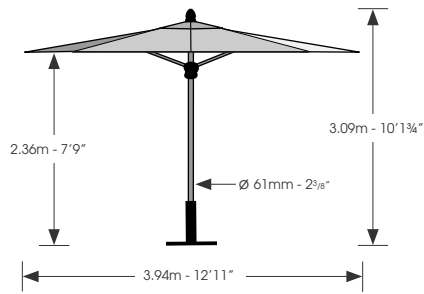

Optional Extras



Parasol Pole Reducer Ring
To remove movement between table top and pole
Brass - 4PR.61
Stainless Steel - 4PRSS.61



Parasol Base Required
Standard - 4PBL
Free Standing - 4PBFP + 4PBFTL

milano 4MI35R

With brass fittings. Suitable for the following tables:

Apex
2AP21
Arundel
2AR24
2ARX28
Eclipse
2EC20
Equinox
2EQ22
2EQX23
Stirling
2STX32
Windsor
2WIX23

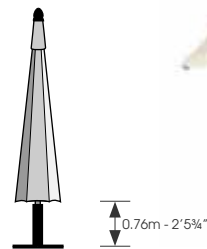
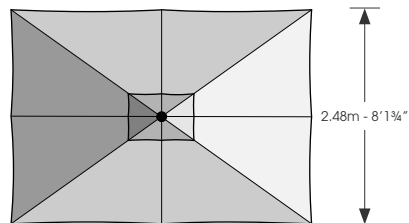
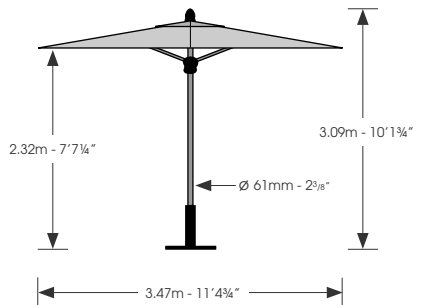

Optional Extras



Parasol Pole Reducer Ring
To remove movement between table top and pole
Brass - 4PR.61
Stainless Steel - 4PRSS.61



Parasol Base Required
Standard - 4PBL
Free Standing - 4PBFP + 4PBFTL

parasols

sorrento

4SO35C

With chrome fittings.
Suitable for the following tables:

Drummond
2DR15
2DR18
Equinox
2EQC15.700
2EQC18.700

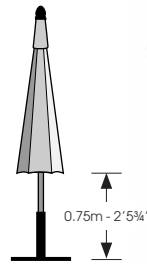
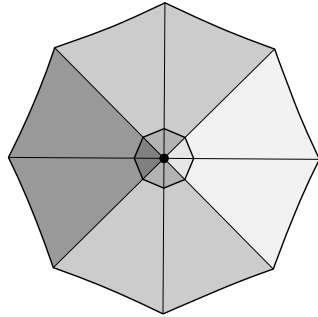
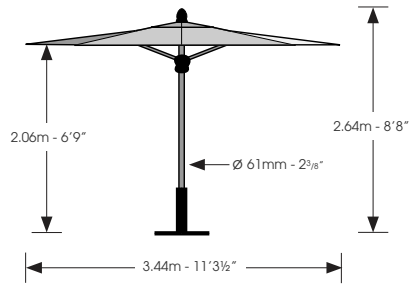

Optional Extras



Parasol Pole Reducer Ring
To remove movement between table top and pole
Brass - 4PR.61
Stainless Steel - 4PRSS.61



Parasol Base Required
Standard - 4PBL
Free Standing - 4PBFP + 4PBFTL

sorrento

4SO40C

With chrome fittings.
Suitable for the following tables:

Drummond
2DR18
Equinox
2EQC18S
2EQC18.700

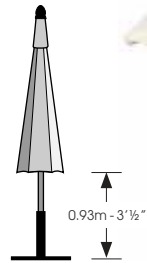
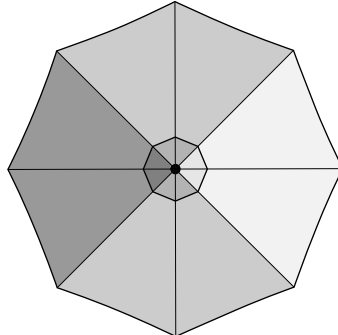
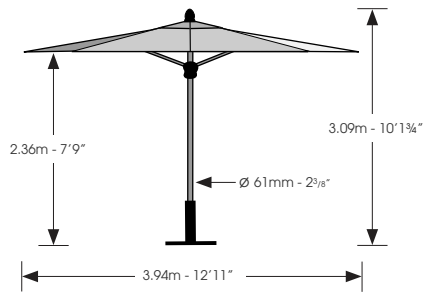

Optional Extras



Parasol Pole Reducer Ring
To remove movement between table top and pole
Brass - 4PR.61
Stainless Steel - 4PRSS.61



Parasol Base Required
Standard - 4PBL
Free Standing - 4PBFP + 4PBFTL

sorrento

4SO35R

With chrome fittings.
Suitable for the following tables:

Apex
2AP21
Arundel
2AR24
2ARX28
Eclipse
2EC20
Equinox
2EQ22
2EQX23
Stirling
2STX32
Windsor
2WIX23

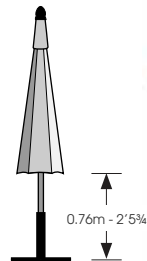
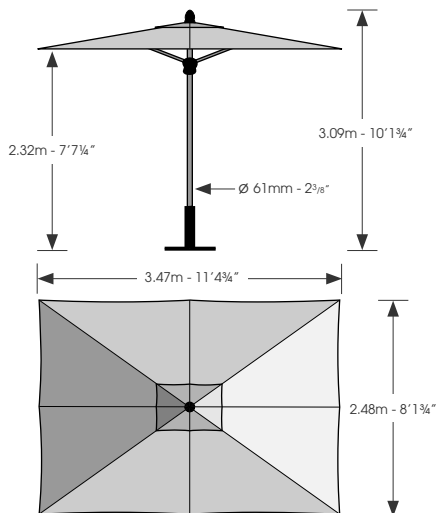

Optional Extras



Parasol Pole Reducer Ring
To remove movement between table top and pole
Brass - 4PR.61
Stainless Steel - 4PRSS.61



Parasol Base Required
Standard - 4PBL
Free Standing - 4PBFP + 4PBFTL

sail
4SA25S

With aluminium pole and ribs. Suitable for the following tables:

- Arundel 2AR09
- Metzo 2MEO9T
- Windsor 2WI08
- Equinox 2EQ10
- 2EQ15
- 2EQ09.700
- 2EQ15.700
- Quattro 2QU10.700
- Aura 2AU09
- 2AU15

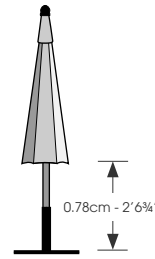
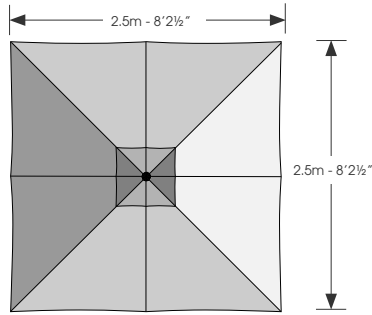
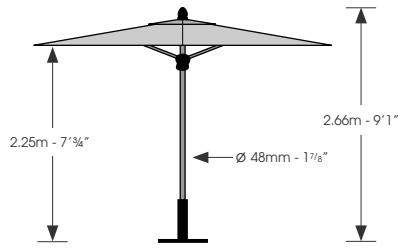

Optional Extras



Parasol Pole Reducer Ring
To remove movement between table top and pole
Brass - 4PR.48
Stainless Steel - 4PRSS.48



Parasol Base Required
Standard - 4PBM
Free Standing - 4PBF + 4PBFTM

sail
4SA30C

With aluminium pole and ribs. Suitable for the following tables:

- Ascot 2AS13
- Balmoral 2BA13
- Drummond 2DR15
- Edinburgh 2EDH09
- Equinox 2EQ15.700
- Haven 2HASC10
- 2HACC10
- Horizon 2HOC15
- Windsor 2WI12
- 2WIC15

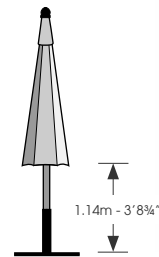
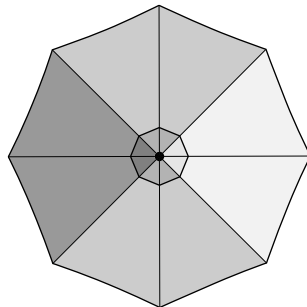
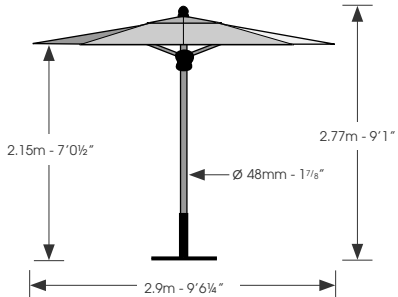

Optional Extras



Parasol Pole Reducer Ring
To remove movement between table top and pole
Brass - 4PR.48
Stainless Steel - 4PRSS.48



Parasol Base Required
Standard - 4PBM
Free Standing - 4PBF + 4PBFTM

sail
4SA30R

With aluminium pole and ribs. Suitable for the following tables:

- Arundel 2AR13
- 2AR18
- Aura 2AU15
- 2AU20
- Equinox 2EQ15
- 2EQ20.700
- Metzo 2ME15T
- Monaco 2MO15
- Stirling 2ST20
- Windsor 2WI15

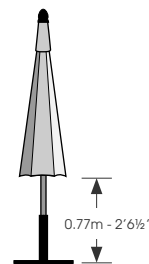
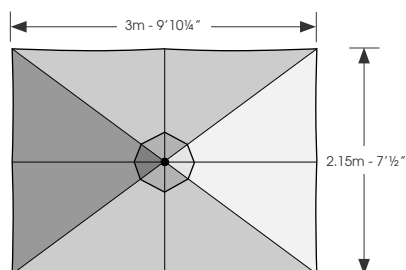
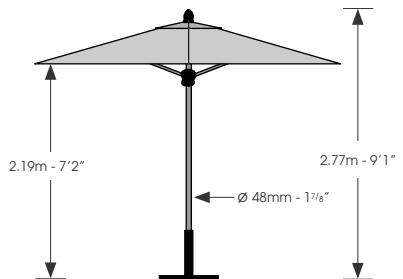

Optional Extras



Parasol Pole Reducer Ring
To remove movement between table top and pole
Brass - 4PR.48
Stainless Steel - 4PRSS.48



Parasol Base Required
Standard - 4PBM
Free Standing - 4PBF + 4PBFTM

parasols

sail

4SA40C

With aluminium pole and ribs. Suitable for the following tables:

- Drummond 2DR18
- Equinox 2EQC18S
- 2EQC18.700

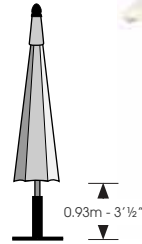
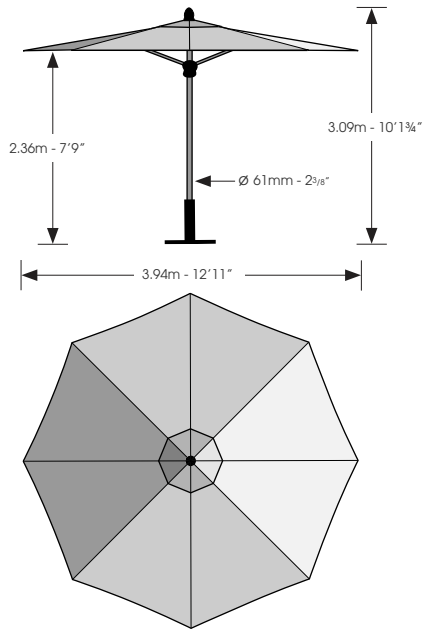

Optional Extras



Parasol Pole Reducer Ring
To remove movement between table top and pole
Brass - 4PR.61
Stainless Steel - 4PRSS.61



Parasol Base Required
Standard - 4PBL
Free Standing - 4PBFP + 4PBFTL

sail

4SA35R

With aluminium pole and ribs. Suitable for the following tables:

- Apex 2AP21
- Arundel 2AR24
- 2ARX28
- Eclipse 2EC20
- Equinox 2EQ22
- 2EQX23
- Stirling 2STX32
- Windsor 2WIX23

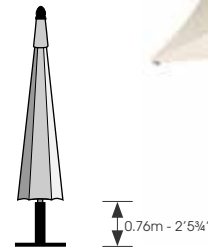
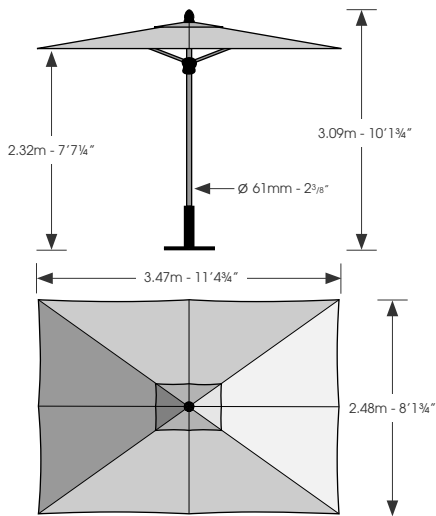

Optional Extras



Parasol Pole Reducer Ring
To remove movement between table top and pole
Brass - 4PR.61
Stainless Steel - 4PRSS.61



Parasol Base Required
Standard - 4PBL
Free Standing - 4PBFP + 4PBFTL



parasols

parasol bases

Standard parasol bases



4PBS
 Ø 40cm - 153/4"
 L 41.5cm - 161/4"
 ⚖ 11.5kg - 25lbs



4PBM
 Ø 60cm - 231/2"
 L 44cm - 171/4"
 ⚖ 25.5kg - 56lbs



4PBL
 Ø 60cm - 231/2"
 L 44cm - 171/4"
 ⚖ 26kg - 57lbs

Free standing parasol bases



4PBFP + 4PBFTS
 W 74cm - 291/4"
 D 74cm - 291/4"
 L 41.5cm - 161/4"
 ⚖ 45kg - 99lbs



4PBFP + 4PBFTM
 W 74cm - 291/4"
 D 74cm - 291/4"
 L 44cm - 171/4"
 ⚖ 46kg - 101lbs



4PBFP + 4PBFTL
 W 74cm - 291/4"
 D 74cm - 291/4"
 L 44cm - 171/4"
 ⚖ 46.5kg - 102lbs

Parasol Base Plates

For 2EQC07, 2EQCH07, 2EQC10, 2EQCH10



4PBPS
 Ø 40cm - 153/4"
 ⚖ 10.5kg - 23lbs
 2EQC07
 2EQCH07



4PBPL
 Ø 60cm - 231/2"
 ⚖ 22kg - 48lbs
 2EQC10
 2EQCH10



reducer rings

storage covers

Parasol Hole Reducer Rings

Brass



4PR.00
 Ø 79mm - 31/4"



4PR.38
 Ø 38mm - 11/2"



4PR.48
 Ø 48mm - 17/8"



4PR.61
 Ø 61mm - 23/8"

Parasol Hole Reducer Rings

Stainless Steel



4PRSS.00
 Ø 79mm - 31/4"



4PRSS.38
 Ø 38mm - 11/2"



4PRSS.48
 Ø 48mm - 17/8"



4PRSS.61
 Ø 61mm - 23/8"

Parasol Storage Covers



4PSCS
 Siena - 4SI25C

4PSCL

Verona - 4VE30C, 4VE30R
 Milano - 4MI35C, 4MI35R, 4MI40C
 Sorrento - 4SO35C, 4SO35R, 4SO40C

specifications

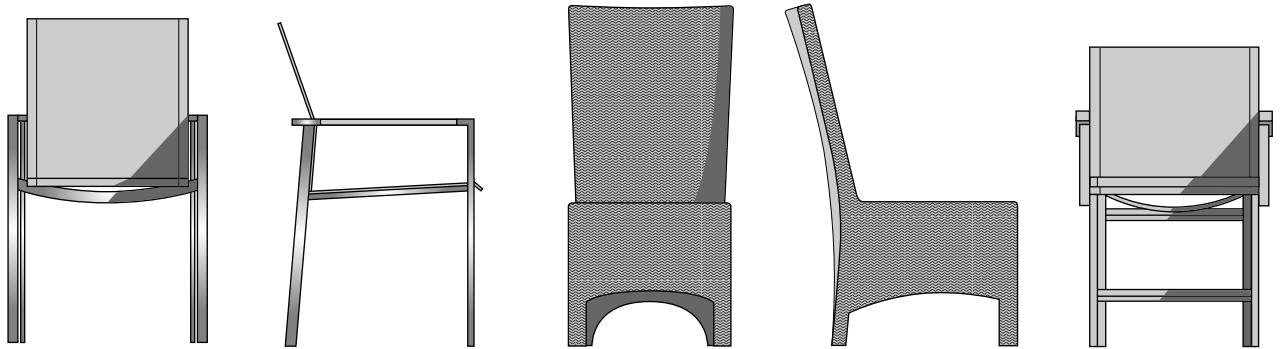

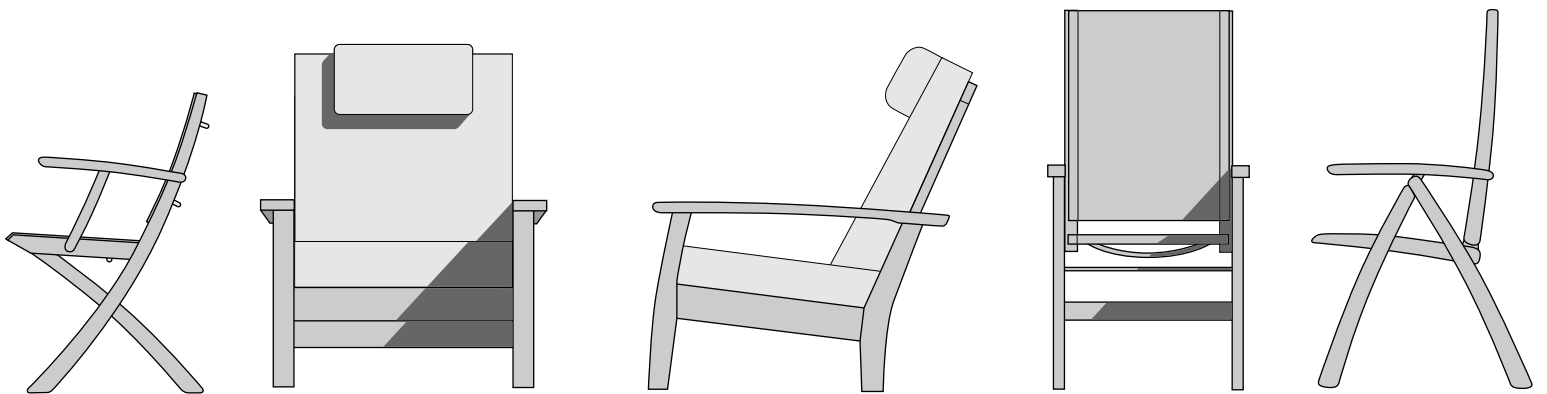

In the following section, we show all our products with a full specification.

Product dimensions and weights are approximate.

Whilst we take care to reproduce colours as accurately as possible, you should only use them as a guide, due to the limitations of the printing process.

Cushions we supply in North America might be different in style and colour from those illustrated.

teak

adirondack



Armchair
1ADA (p. 10)

- 75.5cm - 29 3/4"
- 95.5cm - 37 1/2"
- 96.5cm - 38"
- 17kg - 37lbs



Footrest
1ADFR (p. 11)

- 54cm - 21 1/4"
- 35.5cm - 14"
- 57cm - 22 1/2"
- 6kg - 13lbs



Side Table
2AD (p. 11)

- 62cm - 24 1/2"
- 39cm - 15 1/4"
- 39.5cm - 15 1/2"
- 5.5kg - 12lbs

apex



Armchair
1APA (p. 12)

- 59.5cm - 23 1/2"
- 91cm - 35 3/4"
- 61cm - 24"
- 14kg - 31lbs
- 800087



210 Dining Table
2AP21 (p. 13)

- 210cm - 82 3/4"
- 74.5cm - 29 1/4"
- 109cm - 42 3/4"
- 81kg - 178lbs
- 6 - 8
- 4MI35R, 4SO35R



Without parasol hole

390 Extending Dining Table
2APX39 (p. 12)

- 268.5 / 392cm
105 3/4" / 154 1/4"
- 74.5cm - 29 1/4"
- 119cm - 46 3/4"
- 125kg - 275lbs
- 14

ascot



Folding Side Chair
1AS (p. 14)

- 48cm - 19"
- 95cm - 37 1/2"
- 61.5cm - 24 1/4"
- 7kg - 15lbs
- 800004



Folding Carver Chair
1ASC (p. 15)

- 58cm - 22 3/4"
- 95cm - 37 1/2"
- 61.5cm - 24 1/4"
- 8kg - 17lbs
- 800004



Folding Footstool / Side Table
1ASF5 (p. 14)

- 43.5cm - 17 1/4"
- 40.5cm - 16"
- 43.5cm - 17 1/4"
- 4.5kg - 10lbs
- 800004



Folding Recliner Chair
1ASR (p. 16)

- 59.5cm - 23 1/2"
- 113.5cm - 44 3/4"
- 64cm - 25 1/4"
- 13kg - 28lbs
- 800002, 800003



Folding Recliner Footstool / Side Table
1REF5

- 41.5cm - 16 1/4"
- 41.5cm - 16 1/4"
- 43.5cm - 17"
- 5kg - 11lbs
- 800041



Recliner Clip-on Tray
1RET

- 32cm - 12 1/2"
- 20.5cm - 8"
- 1.3kg - 3lbs
- For 1ASR



110 Folding Dining Table
2AS11 (p. 14)

- ∅ 109cm - 43"
- ┆┆ 70cm - 273/4"
- ⚖ 14kg - 31lbs
- 👤 4
- ⤴ 4SI25C



130 Folding Dining Table
2AS13

- ∅ 130cm - 511/4"
- ┆┆ 70cm - 273/4"
- ⚖ 22.5kg - 50lbs
- 👤 4 - 6
- ⤴ 4VE30C



Armchair
1AVA (p. 18)

- ┆ 60cm - 231/2"
- ┆┆ 87cm - 341/4"
- ┆ 59cm - 231/4"
- ⚖ 7.5kg - 17lbs
- 🛠 800009



200 Dining Table
2AV20 (p. 18)

- ┆ 198cm - 79"
- ┆┆ 74cm - 291/4"
- ┆ 100cm - 391/2"
- ⚖ 47kg - 103lbs
- 👤 6 - 8
- ⤴ 4MI35R



260 Extending Dining Table
2AVX26 (p. 21)

- ┆ 209cm / 258cm
821/2" / 1013/4"
- ┆┆ 74cm - 291/4"
- ┆ 110cm - 431/4"
- ⚖ 57kg - 125lbs
- 👤 8 - 10
- ⤴ 4MI35R, 4SO35R



Lounger - Base
1CAB

- ┆ 198cm - 78"
- ┆┆ 24cm - 91/2"
- ┆ 63cm - 243/4"
- ⚖ 21kg - 46lbs
- 🛠 800006



Brass Clips
1CBC

- ┆ 6.7cm - 25/8"
- ┆ 7.8cm - 31/8"
- ┆ 1.9cm - 3/4"
- ⚖ 300g - 11oz

For connecting two or more Capri Base Loungers



Lounger - Standard
1CAS (p. 23)

- ┆ 197cm - 771/2"
- ┆┆ 31cm - 121/4"
- ┆ 70cm - 273/4"
- ⚖ 19.5kg - 43lbs
- 🛠 800006



Clip-on Tray
1CAT

- ┆ 39.5cm - 151/2"
- ┆ 23cm - 9"
- ⚖ 1.3kg - 3lbs
- For 1CAS

teak

capri



Lounger - Ultra
1CAU (p. 22)

- 197cm - 771/2"
- 31cm - 121/4"
- 74cm - 291/4"
- ⚖ 29kg - 64lbs
- 🛞 800006 (810510 in USA only)

commodore



Folding Steamer Chair
1CO (p. 24)

- 🪑 63.5cm - 25"
- 🪑 99.5cm - 391/4"
- 🪑 146cm - 571/2"
- ⚖ 18.5kg - 41lbs
- 🛞 800066



*Folding Steamer Chair
Wheels and 67cm Footrest*
1CO67W

- 🪑 63.5cm - 25"
- 🪑 102cm - 40"
- 🪑 163cm - 64"
- ⚖ 20.5kg - 45lbs
- 🛞 800067



Folding Recliner Chair
1COC

- 🪑 63.5cm - 25"
- 🪑 112.5cm - 441/4"
- 🪑 82cm - 321/4"
- ⚖ 15kg - 33lbs
- 🛞 800002, 800003

felsted



Armchair
1FEA (p. 50)

- 🪑 55.5cm - 213/4"
- 🪑 86.5cm - 341/4"
- 🪑 61.5cm - 241/4"
- ⚖ 12kg - 26lbs
- 🛞 800001



Footstool / Side Table
1FEFS (p. 54)

- 🪑 42cm - 161/2"
- 🪑 42cm - 161/2"
- 🪑 42cm - 161/2"
- ⚖ 6kg - 13lbs
- 🛞 800041



120 Seat
1FE12

- 🪑 116cm - 453/4"
- 🪑 86.5cm - 341/4"
- 🪑 61.5cm - 241/4"
- ⚖ 17kg - 37lbs
- 🛞 800012



150 Seat
1FE15

- 🪑 147cm - 573/4"
- 🪑 86.5cm - 341/4"
- 🪑 61.5cm - 241/4"
- ⚖ 19kg - 42lbs
- 🛞 800015

A Felsted 180cm Seat, 1FE18KD, is available in the USA only. Please refer to our website www.teak.com for details



Armchair
1GLA (p. 54)

57.5cm - 223/4"
 90cm - 351/2"
 64.5cm - 251/4"
 16kg - 35lbs
 800001



150 Seat
1GL15 (p. 55)

149cm - 583/4"
 90cm - 351/2"
 64.5cm - 251/4"
 26kg - 57lbs
 800015



180 Seat
1GL18

179.5cm - 703/4"
 90cm - 351/2"
 64.5cm - 251/4"
 33kg - 73lbs
 800018



240 Seat
1GL24

236.5cm - 93"
 90cm - 351/2"
 64.5cm - 251/4"
 43kg - 95lbs



Junior Armchair
1GLJA

41.5cm - 161/2"
 65.5cm - 253/4"
 46cm - 18"
 7kg - 15lbs



Junior Seat
1GLJ2

75.5cm - 293/4"
 65.5cm - 253/4"
 46cm - 18"
 9.5kg - 21lbs



Cambridge Junior Table
2CAJ

76cm - 30"
 48cm - 183/4"
 49cm - 191/4"
 8kg - 17lbs

Two half sections are required to make a complete tree seat.
Can be supplied as a single half section if required.



Hexagonal Treeseat
1GLHE

Ø 223.5cm - 88"
 90cm - 351/2"
 45kg - 99lbs

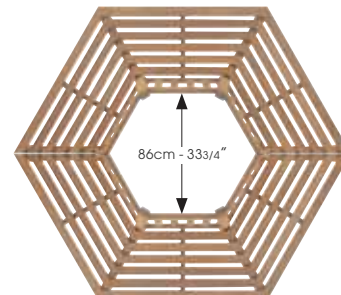

1GLHE + 1GLHE

Two half sections are required to make a complete tree seat.
Can be supplied as a single half section if required.



Circular Treeseat
1GLSC (p. 56)

Ø 219.5cm - 861/2"
 90cm - 351/2"
 46kg - 101lbs

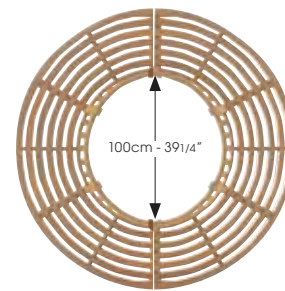

1GLSC + 1GLSC



Curved Seat
1GLR28

☰ 223.5cm - 88"
 ┆ 90cm - 35 1/2"
 ┆ 64.5cm - 25 1/4"
 ⚖ 36kg - 79lbs



Curved Seat - Left
1GLR28L

☰ 221cm - 87"
 ┆ 90cm - 35 1/2"
 ┆ 64.5cm - 25 1/4"
 ⚖ 33kg - 73lbs



Curved Seat - Centre
1GLR28C

☰ 218cm - 85 3/4"
 ┆ 90cm - 35 1/2"
 ┆ 60cm - 23 1/2"
 ⚖ 30kg - 66lbs



Curved Seat - Right
1GLR28R

☰ 221cm - 87"
 ┆ 90cm - 35 1/2"
 ┆ 64.5cm - 25 1/4"
 ⚖ 33kg - 73lbs

The Glenham Curved Seat is also available to special order, as left and right hand sections, plus a centre section. By combining these sections, larger circular seating arrangements are possible.

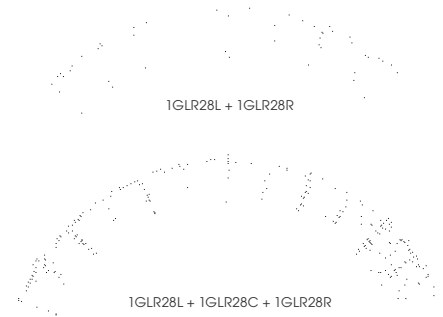

1GLR28L + 1GLR28C + 1GLR28C + 1GLR28R

Two sections are required for complete corner seat. Also available to special order with the 'London' style armrests, which increases the overall lengths by 5cm - 2".



Corner Seat - Left
1GL18CL

☰ 185.5cm - 73"
 ┆ 90cm - 35 1/2"
 ┆ 64.5cm - 25 1/4"
 ⚖ 29kg - 64lbs



Corner Seat - Right
1GL18CR

☰ 185.5cm - 73"
 ┆ 90cm - 35 1/2"
 ┆ 64.5cm - 25 1/4"
 ⚖ 29kg - 64lbs

For cushion colours see page 202



Reclining Armchair
1HADA (p. 26)

☰ 84.5cm - 33 1/4"
 ┆ 101cm - 39 3/4"
 ┆ 97cm - 38 1/4"
 ⚖ 18kg - 40lbs

Note: Headrest not available in USA



Ottoman
1HAO (p. 26)

☰ 79cm - 31"
 ┆ 39.5cm - 15 1/2"
 ┆ 65cm - 25 1/2"
 ⚖ 9kg - 20lbs

For cushion colours see page 200



Left Hand Module
1HADML (p. 27)

- 75cm - 29 1/2"
- 92.5cm - 36 1/2"
- 93cm - 36 1/2"
- 14.5kg - 32lbs



Right Hand Module
1HADMR (p. 27)

- 75cm - 29 1/2"
- 92.5cm - 36 1/2"
- 93cm - 36 1/2"
- 14.5kg - 32lbs



Middle Module
1HADMM (p. 27)

- 65cm - 25 1/2"
- 92.5cm - 36 1/2"
- 90.5cm - 35 1/2"
- 11kg - 24lbs



Corner Module
1HADMC (p. 27)

- 90.5cm - 35 1/2"
- 92.5cm - 36 1/2"
- 90.5cm - 35 1/2"
- 16kg - 35lbs



100 Conversation Table
2HAS10

- 100cm - 39 1/4"
- 48cm - 18 3/4"
- 100cm - 39 1/4"
- 17.5kg - 39lbs
- 4VE30C



100 Conversation Table
2HACC10

- Ø 102cm - 40"
- 48cm - 18 3/4"
- 18kg - 40lbs
- 4VE30C

For sling colours see page 202



Stacking Armchair
1HOAS.T (p. 30)

- 58cm - 23"
- 90cm - 35 1/4"
- 56.5cm - 22 1/4"
- 7.5kg - 17lbs
- 800008



Stacking Armchair

- 1HOAS.500 Charcoal (p. 31)
- 1HOAS.502 Titanium
- 1HOAS.504 Platinum
- 1HOAS.505 Pearl

- 58cm - 23"
- 90cm - 35 1/4"
- 58.5cm - 23"
- 6.5kg - 14lbs



Lounger

- 1HOL.500 Charcoal (p. 34)
- 1HOL.502 Titanium
- 1HOL.504 Platinum
- 1HOL.505 Pearl

- 206.5cm - 81 1/4"
- 32cm - 12 3/4"
- 65.5cm - 25 3/4"
- 16.5kg - 36lbs



Lounger Sun Shade

- 1LSS.500 Charcoal (p. 34)
- 1LSS.502 Titanium
- 1LSS.504 Platinum
- 1LSS.505 Pearl

- 62cm - 24 1/2"
- 35cm - 13 3/4"
- 1kg - 2.4lbs



Folding Side Chair

1HOF.500 Charcoal (p. 28)
 1HOF.502 Titanium
 1HOF.504 Platinum
 1HOF.505 Pearl

☰ 48cm - 183/4"
 ▮ 83.5cm - 323/4"
 ▮ 57cm - 221/2"
 ⚖ 6.5kg - 14lbs



Folding Carver Chair

1HOCF.500 Charcoal (p. 29)
 1HOCF.502 Titanium
 1HOCF.504 Platinum
 1HOCF.505 Pearl

☰ 55cm - 213/4"
 ▮ 83.5cm - 323/4"
 ▮ 57cm - 221/2"
 ⚖ 7kg - 15lbs



Folding Recliner Chair

1HOR.500 Charcoal (p. 32)
 1HOR.502 Titanium
 1HOR.504 Platinum
 1HOR.505 Pearl

☰ 59.5cm - 231/4"
 ▮ 111.5cm - 433/4"
 ▮ 65.5cm - 253/4"
 ⚖ 12kg - 26lbs



150 Dining Table
 2HOC15

∅ 149.5cm - 59"
 ▮ 70cm - 273/4"
 ⚖ 41kg - 90lbs
 👤 6
 ⚙ 4VE30C



180 Dining Table
 2HOC18 (p. 38)

∅ 179.5cm - 703/4"
 ▮ 70cm - 273/4"
 ⚖ 70kg - 154lbs
 👤 8
 ⚙ 4MI40C, 4SO40C



Armchair
 1LIA (p. 37)

☰ 58cm - 23"
 ▮ 90.5cm - 353/4"
 ▮ 61cm - 241/4"
 ⚖ 9kg - 20lbs
 📦 800087



Armchair
1LIDA (p. 40)

-  96.5cm - 38"
-  74cm - 29 1/4"
-  89cm - 35 1/4"
-  18kg - 40lbs







Ottoman
1LIDO (p. 40)

-  84cm - 33"
-  40cm - 15 3/4"
-  84cm - 33"
-  10.5kg - 23lbs



Two Seat Settee
1LID2 (p. 41)

-  180.5cm - 71"
-  74cm - 29 1/4"
-  89cm - 35 1/4"
-  27kg - 59lbs





Three Seat Settee
1LID3 (p. 42)

-  263.5cm - 103 3/4"
-  74cm - 29 1/4"
-  89cm - 35 1/4"
-  42kg - 92lbs



76 Coffee Table
2LIL07 (p. 41)

-  76cm - 30"
-  40cm - 15 3/4"
-  76cm - 30"
-  11kg - 24lbs



76 Side Table
2LILS07 (p. 42)

-  76cm - 30"
-  50.5cm - 20"
-  76cm - 30"
-  12.5kg - 28lbs



120 Coffee Table
2LIL12

-  119cm - 46 3/4"
-  40cm - 15 3/4"
-  63.5cm - 25"
-  14.5kg - 32lbs



150 Coffee Table
2LIL15

-  150cm - 59"
-  40cm - 15 3/4"
-  76.5cm - 30"
-  18.5kg - 41lbs

teak

london



Armchair
1LOA (p. 59)

	69.5cm - 27 1/4"
	90cm - 35 1/2"
	63.5cm - 25"
	17kg - 37lbs
	800001



150 Seat
1LO15 (p. 58)

	161cm - 63 1/4"
	90cm - 35 1/2"
	63.5cm - 25"
	26kg - 57lbs
	800015



180 Seat
1LO18

	191cm - 75 1/4"
	90cm - 35 1/2"
	63.5cm - 25"
	32kg - 70lbs
	800018

mission

For cushion colours see page 200



Reclining Armchair
1MIA (p. 49)

	74cm - 29"
	94.5cm - 37 1/4"
	98.5cm - 38 3/4"
	28.5kg - 63lbs



Footstool
1MFS

	45.5cm - 18"
	35.5cm - 14"
	45.5cm - 18"
	6.2kg - 13.5lbs



60 Coffee Table
2MIL06

	59cm - 23 1/4"
	39.5cm - 15 1/2"
	59cm - 23 1/4"
	10kg - 22lbs

monaco



Folding Side Chair
1MOF (p. 46)

	48cm - 18 3/4"
	87.5cm - 34 1/2"
	57cm - 22 1/2"
	6.5kg - 14lbs
	800004



Folding Carver Chair
1MOCF (p. 46)

	55cm - 21 3/4"
	87.5cm - 34 1/2"
	57cm - 22 1/2"
	7kg - 15lbs
	800004



Side Chair
1MO (p. 45)

	48cm - 18 3/4"
	92.5cm - 36 1/2"
	63cm - 24 3/4"
	10kg - 22lbs
	800005



Armchair
1MOA (p. 44)

	56.5cm - 22 1/4"
	92.5cm - 36 1/2"
	63cm - 24 3/4"
	10kg - 22lbs
	800001



120 Seat
1MO12

	121cm - 47 1/2"
	92.5cm - 36 1/2"
	64cm - 25 1/4"
	17kg - 37lbs
	800012



150 Seat
1MO15

- 146cm - 57 1/2"
- 92.5cm - 36 1/2"
- 64cm - 25 1/4"
- 20kg - 44lbs
- 800015



150 Swing Seat
1MOSW15

- 149.5cm - 58 3/4"
- 65cm - 25 1/2"
- 61cm - 24"
- 21.5kg - 47lbs
- 800015



High Dining Side Chair
1MOH

- 48cm - 18 3/4"
- 121cm - 47 1/2"
- 60cm - 23 3/4"
- 12kg - 26lbs
- 800005



High Dining Carver Chair
1MOCH

- 57cm - 22 1/2"
- 121cm - 47 1/2"
- 60cm - 23 3/4"
- 13kg - 28lbs
- 800005



Lounger
1MOL (p. 48)

- 205cm - 80 3/4"
- 29cm - 11 1/2"
- 78cm - 30 3/4"
- 30kg - 66lbs
- 800006



40 Coffee Table
2MOL04

- 43.5cm - 17 1/4"
- 40cm - 15 3/4"
- 43.5cm - 17 1/4"
- 5kg - 11lbs



60 Coffee Table
2MOL06

- 59cm - 23 1/4"
- 40cm - 15 3/4"
- 59cm - 23 1/4"
- 9kg - 20lbs



100 Coffee Table
2MOL10

- 101cm - 39 3/4"
- 40cm - 15 3/4"
- 59cm - 23 1/4"
- 12kg - 26lbs



150 Coffee Table
2MOL15

- 150cm - 59"
- 39.5cm - 15 1/2"
- 90.5cm - 35 1/2"
- 21.5kg - 47lbs

teak

monaco



150 Dining Table
2MO15

- 150cm - 59"
- 71cm - 273/4"
- 90.5cm - 351/2"
- 23kg - 51lbs
- 4 - 6
- 4VE30R



240 Extending Dining Table
2MOX24

- 175cm / 240cm
69" / 941/2"
- 71cm - 273/4"
- 90.5cm - 351/2"
- 36kg - 79lbs
- 6 - 8
- 4MI35R, 4SO35R

newport



Rocking Chair
1NER (p. 67)

- 64cm - 251/4"
- 105cm - 411/4"
- 88.5cm - 343/4"
- 13kg - 28lbs
- 800002, 800003

rothesay



Armchair
1ROA (p. 60)

- 69.5cm - 271/2"
- 90.5cm - 351/2"
- 65.5cm - 253/4"
- 24kg - 53lbs



180 Seat
1RO18 (p. 61)

- 182cm - 713/4"
- 90.5cm - 351/2"
- 65.5cm - 253/4"
- 37kg - 81lbs



240 Seat
1RO24

- 240.5cm - 941/2"
- 90.5cm - 351/2"
- 65.5cm - 253/4"
- 51kg - 112lbs

safari



Folding Armchair
1SA (p. 52)

- 1SA.200 Forest Green
- 1SA.201 White Sand
- 1SA.204 Pepper
- 1SA.205 Classic Blue
- 1SA.207 Spring (Not available in the USA)
- 60cm - 231/2"
- 81cm - 32"
- 50cm - 191/2"
- 5.5kg - 12lbs



.200 Forest Green



.201 White Sand



.204 Pepper



.205 Classic Blue



.207 Spring (Not available in the USA)



Safari Clip-on Tray
1SAT (p. 52)

- 31cm - 121/4"
- 17cm - 61/2"
- 1.3kg - 3lbs



Folding Table
2SA

- 68cm - 263/4"
- 70cm - 273/4"
- 58cm - 223/4"
- 8kg - 17lbs
- 2

teak

sissinghurst



195 Seat
1SI (p. 62)

- 195.5cm - 77"
- 106cm - 413/4"
- 64.5cm - 25 1/2"
- 38kg - 84lbs

waveney



Armchair
1WAA (p. 65)

- 55.5cm - 21 3/4"
- 85.5cm - 33 3/4"
- 58.5cm - 23"
- 10.5kg - 23lbs
- 800001



120 Seat
1WA12

- 116cm - 45 3/4"
- 87.5cm - 34 1/2"
- 58.5cm - 23"
- 15kg - 33lbs
- 800012



150 Seat
1WA15 (p. 64)

- 147cm - 57 3/4"
- 89cm - 35"
- 58.5cm - 23"
- 18.5kg - 41lbs
- 800015

wimbledon



120 Bench
1W112 (p. 67)

- 121cm - 47 3/4"
- 41.5cm - 16 1/2"
- 53cm - 20 3/4"
- 13kg - 28lbs
- 800068



150 Bench
1W115 (p. 67)

- 149cm - 58 3/4"
- 41.5cm - 16 1/2"
- 53cm - 20 3/4"
- 16kg - 35lbs
- 800069



180 Bench
1W118 (p. 67)

- 179.5cm - 70 3/4"
- 42.5cm - 16 3/4"
- 53cm - 20 3/4"
- 20kg - 44lbs
- 800071

arundel



90 Dining Table
2AR09

- 90cm - 35 1/2"
- 70cm - 27 3/4"
- 90cm - 35 1/2"
- 24kg - 53lbs
- 4
- 4SI25C



180 Dining Table
2AR18 (p. 15)

- 180cm - 70 3/4"
- 70cm - 27 3/4"
- 90cm - 35 1/2"
- 42kg - 92lbs
- 6 - 8
- 4VE30R

teak

arundel



240 Dining Table
2AR24 (p. 54)

- 240cm - 941/2"
- 70cm - 273/4"
- 108.5cm - 423/4"
- 51.5kg - 113lbs
- 8 - 10
- 4MI35R, 4SO35R

Without parasol hole when closed



285 Extending Dining Table
2ARX28 (p. 16)

- 204.5 / 286.5cm
801/2" / 1123/4"
- 70cm - 273/4"
- 110cm - 431/4"
- 75kg - 165lbs
- 10 - 12
- 4MI35R, 4SO35R

balmoral



110 Dining Table
2BA11

- Ø 109cm - 43"
- 70cm - 273/4"
- 23kg - 51lbs
- 4
- 4SI25C



130 Dining Table
2BA13 (p. 50)

- Ø 130cm - 511/4"
- 70cm - 273/4"
- 31kg - 68lbs
- 4 - 6
- 4VE30C

drummond



150 Dining Table
2DR15

- Ø 150cm - 59"
- 70cm - 273/4"
- 46kg - 101lbs
- 6
- 4VE30C



75 Lazy Susan
2LS07

- Ø 74cm - 291/4"
- 7kg - 15lbs



180 Dining Table
2DR18

- Ø 185cm - 723/4"
- 70cm - 273/4"
- 65kg - 143lbs
- 8
- 4MI40C, 4SO40C



110 Lazy Susan
2LS11

- Ø 109cm - 43"
- 14kg - 31lbs

edinburgh



90 Coffee Table
2EDL09

- Ø 90cm - 351/2"
- 42.5cm - 163/4"
- 16kg - 35lbs



90 Dining Table
2ED09 (p. 65)

- Ø 90cm - 351/2"
- 70cm - 273/4"
- 19kg - 42lbs
- 2 - 4
- 4SI25C



90 High Dining Table
2EDH09

- Ø 90cm - 351/2"
- 98.5cm - 383/4"
- 22kg - 49lbs
- 2 - 4
- 4SI25C

teak

metzo



90 Dining Table
2ME09T (p. 114)

- 89.5cm - 35 1/4"
- 74.5cm - 29 1/4"
- 89.5cm - 35 1/4"
- 29kg - 64lbs
- 4
- 4SI25C



150 Dining Table
2ME15T

- 149.5cm - 59"
- 74.5cm - 29 1/4"
- 89.5cm - 35 1/4"
- 37kg - 97lbs
- 6
- 4VE30R

stirling



200 Dining Table
2ST20

- 200cm - 78 3/4"
- 70cm - 27 3/4"
- 108.5cm - 42 3/4"
- 46kg - 101lbs
- 6 - 8
- 4VE30R



320 Extending Dining Table
2STX32

- 237cm / 319cm
93 1/4" / 125 1/2"
- 70cm - 27 3/4"
- 110cm - 43 1/4"
- 78kg - 172lbs
- 10 - 12
- 4MI35R, 4SO35R

windsor



82 Dining Table
2WI08

- 82.5cm - 32 1/2"
- 70cm - 27 3/4"
- 82.5cm - 32 1/2"
- 16kg - 35lbs
- 2 - 4
- 4SI25C



120 Dining Table
2WI12

- 119.5cm - 47"
- 70cm - 27 3/4"
- 82.5cm - 32 1/2"
- 21kg - 46lbs
- 4 - 6
- 4VE30R



150 Dining Table
2WI15

- 150cm - 59"
- 70cm - 27 3/4"
- 82.5cm - 32 1/2"
- 23kg - 51lbs
- 6
- 4VE30R



235 Extending Dining Table
2WIX23 (p. 45)

- 170cm / 235cm
67" / 92 1/2"
- 71cm - 27 3/4"
- 103cm - 40 3/4"
- 50kg - 110lbs
- 6 - 8
- 4MI35R, 4SO35R



150 Dining Table
2WIC15 (p. 46)

- Ø 150cm - 59"
- 70cm - 27 3/4"
- 30kg - 66lbs
- 6
- 4VE30C



75 Lazy Susan
2LS07 (p. 46)





- Ø 74cm - 29 1/4"
- 7kg - 15lbs

accessories

cambridge

76 Coffee Table
2CA



 76cm - 30"
 36.5cm - 14 1/4"
 49cm - 19 1/4"
 7.5kg - 17lbs

colchester

54 Coffee Table
2COL (p. 32)



 54.5cm - 21 1/2"
 40cm - 15 3/4"
 54.5cm - 21 1/2"
 8kg - 17lbs

54 Side Table
2COH



 54.5cm - 21 1/2"
 54cm - 21 1/4"
 54.5cm - 21 1/2"
 9kg - 20lbs

crichton



Serving Trolley
2CR (p. 66)



 124.5cm - 49"
 85cm - 33 1/2"
 62.5cm - 24 1/2"
 37kg - 81lbs

Serving Tray
3ST (p. 66)



 53.5cm - 21"
 36cm - 14 1/4"
 2.5kg - 5lbs

caisse versailles

45 Caisse Versailles
3CV45 (p. 67)



 45.5cm - 18"
 51cm - 20 1/4"
 45.5cm - 18"
 12kg - 26lbs

60 Caisse Versailles
3CV60



 60.5cm - 23 3/4"
 66.5cm - 26 1/4"
 60.5cm - 23 3/4"
 21kg - 46lbs

reims

Refreshments Chest
3RE (p. 66)



 81cm - 31 3/4"
 60cm - 23 1/2"
 57.5cm - 22 3/4"
 35kg - 77lbs

The Reims Refreshments chest has an inner liner of polypropylene and can easily accommodate twelve bottles of Champagne or any other refreshments needing to be kept cool. Melted ice can be drained using the solid brass tap at the back of the chest.

storage chests

Storage Chest
3SC11



 114cm - 45"
 72.5cm - 28 1/2"
 63cm - 24 3/4"
 50kg - 110lbs

Storage Chest
3SC15 (p. 66)



 157.5cm - 62"
 72.5cm - 28 1/2"
 84.5cm - 33 1/4"
 70kg - 154lbs

stainless steel

equinox

316 grade stainless steel

For sling and armrest colours see page 202



Stacking Side Chair

1EQ.500 Charcoal
1EQ.502 Titanium
1EQ.504 Platinum
1EQ.505 Pearl

51cm - 20"
85cm - 33 1/2"
61cm - 24"
8kg - 17lbs



Stacking Armchair

Armrest Sling

1EQA.01.500	Graphite	- Charcoal
1EQA.01.502	Graphite	- Titanium
1EQA.01.504	Graphite	- Platinum
1EQA.02.505	Arctic White	- Pearl
1EQA.500	Teak	- Charcoal
1EQA.502	Teak	- Titanium
1EQA.504	Teak	- Platinum
1EQA.505	Teak	- Pearl

(p. 72)

60cm - 23 1/2"
85cm - 33 1/2"
61.5cm - 24 1/4"
9kg - 20lbs

Stacking Lounger

Armrest Sling

1EQL.01.500	Graphite	- Charcoal
1EQL.01.502	Graphite	- Titanium
1EQL.01.504	Graphite	- Platinum
1EQL.02.505	Arctic White	- Pearl

(p. 78)



196.5cm - 77 1/4"
31.5cm - 12 1/4"
68.5cm - 27"
23kg - 51lbs

Armrest Sling

1EQL.500	Teak	- Charcoal
1EQL.502	Teak	- Titanium
1EQL.504	Teak	- Platinum
1EQL.505	Teak	- Pearl

Lounger Sun Shade

1LSS.500 Charcoal
1LSS.502 Titanium
1LSS.504 Platinum
1LSS.505 Pearl



62cm - 24 1/2"
35cm - 13 3/4"
1kg - 2.4lbs

(p. 100)



Stacking Side Chair

1EQ.T (p. 70)

51cm - 20"
85cm - 33 1/2"
61cm - 24"
8kg - 18lbs
800005



Stacking Armchair

1EQA.T (p. 71)

60cm - 23 1/2"
85cm - 33 1/2"
61.5cm - 24 1/4"
9kg - 20lbs
800005



Side Chair

1EQH.T (p. 83)

47.5cm - 18 3/4"
106.5cm - 42"
50.5cm - 20"
8kg - 18lbs



Carver Chair

1EQHC.T (p. 83)

56.5cm - 22 1/4"
106.5cm - 42"
50.5cm - 20"
9.5kg - 21lbs



Stool

1EQHS.T (p. 82)

45.5cm - 16 1/4"
72cm - 28 1/4"
48cm - 18 3/4"
7.5kg - 17lbs



Backless Bench

1EQ13 (p. 71)

135.5cm - 53 1/4"
43cm - 17"
44cm - 17 1/4"
16kg - 35lbs

stainless steel

equinox

316 grade
stainless steel







Stacking Lounger
1EQLT (p. 79)

-  196.5cm - 77 1/4"
-  31.5cm - 12 1/4"
-  68.5cm - 27"
-  23kg - 51lbs
-  800006



Lounge Side Table
2EQLT (p. 81)

-  49cm - 19 1/4"
-  30cm - 11 3/4"
-  35cm - 13 3/4"
-  6.5kg - 14lbs



40 Coffee Table
2EQL04 (p. 84)

-  43.5cm - 17 1/4"
-  40cm - 15 3/4"
-  43.5cm - 17 1/4"
-  9kg - 20lbs



60 Coffee Table
2EQL06 (p. 94)

-  59cm - 23 1/4"
-  40cm - 15 3/4"
-  59cm - 23 1/4"
-  11kg - 24lbs







100 Coffee Table
2EQL10

-  101cm - 39 3/4"
-  40cm - 15 3/4"
-  59cm - 23 1/4"
-  15kg - 33lbs







114 Serving Table
2EQS (p. 83)

-  114cm - 44 3/4"
-  85cm - 33 1/2"
-  59cm - 23 1/4"
-  29kg - 65lbs





100 Conversation Table
2EQSC10

-  97cm - 39 1/4"
-  48cm - 18 3/4"
-  100cm - 38 1/4"
-  22kg - 48lbs
-  4SI25C







100 Conversation Table
2EQCC10 (p. 92)

-  Ø 102cm - 40"
-  48cm - 18 3/4"
-  20kg - 44lbs
-  4SI25C









100 Dining Table
2EQ10 (p. 72)

-  97cm - 38 1/4"
-  73cm - 28 3/4"
-  100cm - 39 1/4"
-  25kg - 55lbs
-  4
-  4SI25C



150 Dining Table
2EQ15 (p. 71)

-  149cm - 58 3/4"
-  73cm - 28 3/4"
-  100cm - 39 1/4"
-  30kg - 66lbs
-  6
-  4VE30R

stainless steel

equinox

316 grade
stainless steel



220 Dining Table
2EQ22

▮ 216.5cm - 85 1/4"
┆┆ 73cm - 28 3/4"
▮ 100cm - 39 1/4"
⚖ 42kg - 92lbs
👤 8
⚙ 4SO35R



230 Extending Dining Table
2EQX23 (p. 87)

▮ 151 / 228cm - 59 1/4" / 89 3/4"
┆┆ 73cm - 28 3/4"
▮ 100cm - 39 1/4"
⚖ 45.5kg - 100lbs
👤 6 - 8
⚙ 4SO35R



150 Dining Table
2EQC15S (p. 75)

∅ 147.5cm - 58"
┆┆ 70cm - 27 3/4"
⚖ 46kg - 101lbs
👤 6
⚙ 4SO35C



70 Lazy Susan
2EQLS07

∅ 67cm - 26 1/2"
⚖ 6kg - 13lbs



180 Dining Table
2EQC18S (p. 86)

∅ 179.5cm - 70 3/4"
┆┆ 70cm - 27 3/4"
⚖ 65kg - 143lbs
👤 8
⚙ 4SO35C, 4SO40C



100 Lazy Susan
2EQLS10

∅ 102cm - 40"
⚖ 13kg - 28lbs



70 Bistro Table
2EQC07 (p. 74)

∅ 67cm - 26 1/2"
┆┆ 70cm - 27 3/4"
⚖ 10.5kg - 23lbs
👤 2
⚙ 4SI25C



100 Dining Table
2EQC10 (p. 70)

∅ 102cm - 40"
┆┆ 70cm - 27 3/4"
⚖ 19kg - 42lbs
👤 4
⚙ 4SI25C



70 High Dining Table
2EQCH07

∅ 67cm - 26 1/2"
┆┆ 98.5cm - 38 3/4"
⚖ 12kg - 26lbs
👤 2
⚙ 4SI25C



100 High Dining Table
2EQCH10

∅ 102cm - 40"
┆┆ 98.5cm - 38 3/4"
⚖ 20kg - 44lbs
👤 4
⚙ 4SI25C

stainless steel

equinox

316 grade
stainless steel

For laminate top colour see page 205



90 Dining Table
2EQ09.700 Slate Grey

- 90cm - 35 1/2"
- 71cm - 28"
- 90cm - 35 1/2"
- 26.5kg - 58lbs
- 4
- 4VE30R, 4VE30C

Laminate Top



150 Dining Table
2EQ15.700 Slate Grey

- 145cm - 57"
- 71cm - 28"
- 90cm - 35 1/2"
- 32kg - 70lbs
- 6
- 4VE30R

Laminate Top



200 Dining Table
2EQ20.700 Slate Grey (p. 77)

- 200cm - 78 3/4"
- 71cm - 28"
- 90cm - 35 1/2"
- 42kg - 92lbs
- 8
- 4SO35R

Laminate Top



150 Dining Table with Lazy Susan
2EQC15.700 Slate Grey

- Ø 150cm - 59"
- 73cm - 28 3/4"
- 53kg - 117lbs
- 6
- 4SO35C

Laminate Top

Lazy Susan

- Ø 69.5cm - 27 1/4"
- Laminate Top



180 Dining Table with Lazy Susan
2EQC18.700 Slate Grey (p. 90)

- Ø 180cm - 70 3/4"
- 73cm - 28 3/4"
- 73.5kg - 162lbs
- 8
- 4SO40C

Laminate Top

Lazy Susan

- Ø 84.5cm - 33 1/4"
- Laminate Top

For cushion colours see page 200



Armchair
1EQDA (p. 85)

- 74cm - 29 1/4"
- 81.5cm - 32 1/4"
- 94cm - 37"
- 19kg - 42lbs



Two Seat Settee
1EQD2 (p. 84)

- 138cm - 54 1/4"
- 81.5cm - 32 1/4"
- 94cm - 37"
- 30kg - 66lbs

stainless steel

equinox

316 grade stainless steel



Three Seat Settee
1EQD3 (p. 84)

	202cm - 79 1/2"
	81.5cm - 32 1/4"
	94cm - 37"
	42kg - 92lbs



Ottoman
1EQDO

	74cm - 29 1/4"
	44.5cm - 17 1/2"
	70.5cm - 27 3/4"
	12.5kg - 27.5lbs

mercury

316 grade stainless steel

For sling and armrest colours see page 203



	56cm - 22"
	90cm - 35 1/2"
	57cm - 22 1/2"
	6.5kg - 14lbs

Stacking Armchair

Armrest Sling

1MEA,01,500	Graphite	- Charcoal
1MEA,01,502	Graphite	- Titanium
1MEA,01,504	Graphite	- Platinum
1MEA,02,505	Arctic White	- Pearl
1MEA,500	Teak	- Charcoal
1MEA,502	Teak	- Titanium
1MEA,504	Teak	- Platinum
1MEA,505	Teak	- Pearl

For glass top colours see page 205

Without parasol hole

120 Dining Table



2MEC12,604 Sea Ice
2MEC12,605 Platinum
2MEC12,606 Charcoal

	120cm - 47 1/4"
	74cm - 29 1/4"
	28.5kg - 63lbs
	4

Glass top

For glass top colours see page 205

Without parasol hole



220 Dining Table

2ME22,604 Sea Ice (p. 88)
2ME22,605 Platinum
2ME22,606 Charcoal

	220cm - 86 1/2"
	74cm - 29 1/4"
	101cm - 39 3/4"
	72kg - 158lbs
	6

Glass top

For ceramic top colour see page 205



Serving Table

2MES (p. 96)

	122cm - 48"
	94cm - 37"
	59.5cm - 23 1/4"
	53kg - 117lbs

Ceramic top

Mercury Deep Seating supplied with all weather cushions in Sunbrella V77 Barrier Finish fabric.



Armchair
1MEDAC (p. 92)

	87cm - 34 1/4"
	72cm - 28 1/4"
	81cm - 31 1/4"
	23.5kg - 52lbs



Ottoman
1MEDO (p. 95)

	75cm - 29 1/2"
	42cm - 16 1/2"
	75cm - 29 1/2"
	13kg - 28lbs



Left Hand Module
1MEDL

	81cm - 31 3/4"
	72cm - 28 1/4"
	81cm - 31 3/4"
	20.5kg - 45lbs



Right Hand Module
1MEDR

	81cm - 31 3/4"
	72cm - 28 1/4"
	81cm - 31 3/4"
	20.5kg - 45lbs

stainless steel

mercury

316 grade stainless steel



Middle Module
1MEDM (p. 94)

- 67cm - 26 1/4"
- 72cm - 28 1/4"
- 75cm - 29 1/4"
- 17.5kg - 38lbs



Corner Module
1MEDC (p. 95)

- 81cm - 31 3/4"
- 72cm - 28 1/4"
- 81cm - 31 3/4"
- 20.5kg - 45lbs



76 Coffee Table
2MEL07.700

- 76cm - 30"
 - 26cm - 10 1/4"
 - 76cm - 30"
 - 12kg - 26lbs
- Laminate Top

quattro

304 grade stainless steel

For sling colours see page 202



- 55cm - 21 1/2"
- 83.5cm - 33"
- 64cm - 25 1/4"
- 7.5kg - 17lbs

Stacking Armchair
Armrest Sling

- | | Armrest | Sling |
|-------------|--------------|------------|
| 1QUA.01.500 | Graphite | - Charcoal |
| 1QUA.01.502 | Graphite | - Titanium |
| 1QUA.01.504 | Graphite | - Platinum |
| 1QUA.02.505 | Arctic White | - Pearl |
| 1QUA.500 | Teak | - Charcoal |
| 1QUA.502 | Teak | - Titanium |
| 1QUA.504 | Teak | - Platinum |
| 1QUA.505 | Teak | - Pearl |



Lounger

- 1QUL.500 Charcoal
- 1QUL.502 Titanium
- 1QUL.504 Platinum (p. 100)
- 1QUL.505 Pearl
- 196.5cm - 77 1/4"
- 30cm - 11 3/4"
- 75cm - 29 1/2"
- 15kg - 33lbs

For laminate top colour see page 205



Lounger Sun Shade

- 1LSS.500 Charcoal
- 1LSS.505 Pearl
- 1LSS.502 Titanium
- 1LSS.504 Platinum (p. 100)
- 62cm - 24 1/2"
- 35cm - 13 3/4"
- 1kg - 2.4lbs



Lounger Side Table

- 2QULT.700 Slate Grey (p. 100)
 - 35cm - 13 3/4"
 - 30cm - 11 3/4"
 - 35cm - 13 3/4"
 - 3kg - 6.5lbs
- Laminate top

For laminate top colour see page 205

Without parasol hole



100 Dining Table
2QU10.700 Slate Grey (p. 99)

- 95cm - 37 1/2"
 - 73cm - 28 3/4"
 - 95cm - 37 1/2"
 - 22kg - 48.5lbs
 - 2 - 4
- Laminate top

Without parasol hole



200 Dining Table
2QU20.700 Slate Grey (p. 98)

- 187.5cm - 73 3/4"
 - 73cm - 28 3/4"
 - 95cm - 37 1/2"
 - 40kg - 88lbs
 - 6 - 8
- Laminate top

aura



Stacking Armchair (p. 104)

	Frame	Sling	
1AUA.01.500	Graphite	- Charcoal	(p. 104)
1AUA.01.502	Graphite	- Titanium	
1AUA.01.504	Graphite	- Platinum	
1AUA.02.505	Arctic White	- Pearl	(p. 107)

	58cm - 223/4"
	90,5cm - 353/4"
	66cm - 26"
	6,5kg - 14lbs

For frame colours see page 203

90 Dining Table (p. 106)



	Frame
2AU09.01	Graphite
2AU09.02	Arctic White
	90cm - 351/2"
	74cm - 29"
	90cm - 351/2"
	17,5kg - 38lbs
	4
	4VE30R, 4VE30C

150 Dining Table (p. 107)



	Frame
2AU15.01	Graphite
2AU15.02	Arctic White
	145cm - 57"
	74cm - 29"
	90cm - 351/2"
	24kg - 53lbs
	4 - 6
	4VE30R

200 Dining Table



	Frame
2AU20.01	Graphite (p. 104)
2AU20.02	Arctic White
	200cm - 783/4"
	74cm - 29"
	90cm - 351/2"
	30,5kg - 67lbs
	4 - 6
	4SO35R

For frame and sling colours see page 202

High Dining Carver Chair



	Frame	Sling	
1AUHC.01.500	Graphite	- Charcoal	(p. 108)
1AUHC.01.502	Graphite	- Titanium	
1AUHC.01.504	Graphite	- Platinum	
1AUHC.02.505	Arctic White	- Pearl	(p. 108)
	57cm - 233/4"		
	119cm - 223/4"		
	65cm - 253/4"		
	6kg - 13lbs		

High Dining Table



	Frame	
2AUH14.01	Graphite	
2AUH14.02	Arctic White	(p. 108)
	139cm - 543/4"	
	105cm - 411/4"	
	71cm - 28"	
	24kg - 53lbs	
	Teak top	

Armchair



	Frame	Sling	
1AUDA.01.500	Graphite	- Charcoal	(p. 111)
1AUDA.01.502	Graphite	- Titanium	
1AUDA.01.504	Graphite	- Platinum	
1AUDA.02.505	Arctic White	- Pearl	
	69cm - 271/4"		
	87cm - 341/4"		
	79,5cm - 311/4"		
	5kg - 11lbs		

Footstool



	Frame	Sling	
1AUF5.01.500	Graphite	- Charcoal	(p. 111)
1AUF5.01.502	Graphite	- Titanium	
1AUF5.01.504	Graphite	- Platinum	
1AUF5.02.505	Arctic White	- Pearl	
	55cm - 213/4"		
	40cm - 153/4"		
	55cm - 213/4"		
	3kg - 7lbs		



Armchair

601351 Sahara
601361 Java (p. 143)

☐ 104cm - 41"
┌ 76cm - 30"
└ 104cm - 41"
⚖ 26.5kg - 58lbs



104 Ottoman

601350 Sahara
601360 Java (p. 143)

☐ 104cm - 41"
┌ 40cm - 153/4"
└ 104cm - 41"
⚖ 19kg - 42lbs



76 Ottoman

601352 Sahara
601362 Java

☐ 76cm - 30"
┌ 40cm - 153/4"
└ 76cm - 30"
⚖ 11kg - 24lbs



Left Hand Unit

601354 Sahara (p. 140)
601364 Java (p. 138)

☐ 104cm - 41"
┌ 76cm - 30"
└ 104cm - 41"
⚖ 16kg - 35lbs



Right Hand Unit

601355 Sahara (p. 141)
601365 Java (p. 138)

☐ 104cm - 41"
┌ 76cm - 30"
└ 104cm - 41"
⚖ 16kg - 35lbs



Corner Unit

601356 Sahara (p. 140)
601366 Java (p. 138)

☐ 104cm - 41"
┌ 76cm - 30"
└ 104cm - 41"
⚖ 17kg - 37lbs



Center Unit

601357 Sahara (p. 140)
601367 Java (p. 138)

☐ 76cm - 30"
┌ 76cm - 30"
└ 104cm - 41"
⚖ 12kg - 26lbs



End Table

601652 Sahara
601662 Java (p. 143)

☐ 47cm - 181/2"
┌ 60cm - 231/2"
└ 47cm - 181/2"
⚖ 9kg - 20lbs



76 Coffee Table

601650 Sahara
601660 Java (p. 138)

☐ 76cm - 30"
┌ 46cm - 18"
└ 76cm - 30"
⚖ 12.5kg - 28lbs



120 Coffee Table

601651 Sahara (p. 141)
601661 Java (p. 143)

☐ 120cm - 471/4"
┌ 46cm - 18"
└ 76cm - 30"
⚖ 17kg - 37lbs

dune

Cushion colours
page 200

Weave and colour
samples page 203



Armchair

602351 Straw
602361 Java (p. 146)

- ☰ 102cm - 40 1/4"
- ┌ 83cm - 32 3/4"
- └ 95cm - 37 1/2"
- ⚖ 21.7kg - 48lbs



Conversation Table

602650 Straw
602660 Java (p. 146)

- ∅ 100cm - 39 1/4"
- ┌ 48cm - 18 3/4"
- ⚖ 22.5kg - 49lbs
- Glass top



Two Seat Settee

602352 Straw
602362 Java (p. 147)

- ☰ 162cm - 64"
- ┌ 83cm - 32 3/4"
- └ 95cm - 37 1/2"
- ⚖ 34kg - 75lbs



Daybed and Ottoman

602700 Straw (p. 145)
602750 Java (p. 144)

- ☰ 189cm - 74 1/2"
- ┌ 81.5cm - 32"
- └ 130cm - 51 1/4"
- ⚖ 48kg - 106lbs



- ☰ 140cm - 55"
- ┌ 35.5cm - 14"
- └ 62cm - 24 1/2"

nevada

Cushion colours
page 200

Weave and colour
samples page 203



Armchair

605100 (p. 114)

- ☰ 57.5cm - 22 3/4"
- ┌ 82.5cm - 32 1/2"
- └ 66cm - 26"
- ⚖ 8.5kg - 19lbs
- 👉 800080



Armchair

605351 (p. 116)

- ☰ 73cm - 28 3/4"
- ┌ 81cm - 32"
- └ 86cm - 33 3/4"
- ⚖ 12.5kg - 28lbs



Three Seat Settee

605353 (p. 117)

- ☰ 203cm - 80"
- ┌ 86cm - 32 1/4"
- └ 94cm - 37"
- ⚖ 29.5kg - 65lbs

woven

nevada



Ottoman
605350 (p. 114)

73cm - 283/4"
37cm - 14 1/2"
69cm - 27 1/4"
5kg - 11lbs



Sun Lounger
605470 (p. 118)

199.5cm - 78 1/2"
27cm - 10 3/4"
82cm - 32 1/4"
24kg - 53lbs

savannah

Cushion colours
page 200

Weave and colour
samples page 203



Dining Side Chair
603171 (p. 150)

46.5cm - 18 1/4"
95cm - 37 1/2"
65.5cm - 25 3/4"
5.5kg - 12lbs
800064



Dining Armchair
603100 (p. 149)

61cm - 24"
95cm - 37 1/2"
65.5cm - 25 3/4"
8kg - 17lbs
800056



Armchair
603351 (p. 152)

77.5cm - 30 1/2"
97.5cm - 38 1/2"
87cm - 34 1/4"
15kg - 33lbs



Ottoman
603350 (p. 153)

62cm - 24 1/2"
41cm - 16 1/4"
62cm - 24 1/2"
7kg - 15lbs



Two Seat Settee
603352 (p. 153)

140.5cm - 55 1/4"
97.5cm - 38 1/2"
87cm - 34 1/4"
25kg - 55lbs



Three Seat Settee
603353 (p. 153)

200.5cm - 79"
97.5cm - 38 1/2"
87cm - 34 1/4"
33.5kg - 74lbs



Sun Lounger
603470 (p. 154)

208.5cm - 82"
33cm - 13"
75.5cm - 29 3/4"
19.5kg - 43lbs
800062



Sun Lounger Side Table
603700 (p. 154)

49cm - 19 1/4"
30.5cm - 12"
35cm - 13 3/4"
4.5kg - 10lbs
Clear glass top

Cushion colours
page 200

Weave and colour
samples page 203



40 End Table
603670 (p. 153)



-  46.5cm - 18 1/4"
 -  54cm - 21 1/4"
 -  46.5cm - 18 1/4"
 -  7.5kg - 17lbs
- Clear glass top



95 Coffee Table
603650



-  96.5cm - 38"
 -  42cm - 16 1/2"
 -  63.5cm - 25"
 -  16.5kg - 36lbs
- Clear glass top





150 Coffee Table
603651 (p. 153)



-  150.5cm - 59 1/4"
 -  42cm - 16 1/2"
 -  96.5cm - 38"
 -  35.5kg - 78lbs
- Clear glass top

120 Dining Table
603522



-  125cm - 49 1/4"
 -  71.5cm - 28 1/4"
 -  19.5kg - 43lbs
 -  4
 -  4SI25C
- Clear glass top







150 Dining Table
603524 (p. 149)



-  145.5cm - 57 1/4"
 -  71.5cm - 28 1/4"
 -  24kg - 53lbs
 -  6
 -  4MI35C, 4SO35C
- Clear glass top

200 Dining Table
603565 (p. 150)







-  197.5cm - 77 3/4"
 -  72.5cm - 28 1/2"
 -  104cm - 41"
 -  37.5kg - 83lbs
 -  8
 -  4MI35R, 4SO35R
- Clear glass top

LAURA KIRAR

Cushion colours
page 204

Weave and colour
samples page 204



- Dining Armchair*
606100 Java (p. 129)
606110 Driftwood (p. 132)
-  58cm - 22 3/4"
 -  83cm - 32 3/4"
 -  66cm - 26"
 -  6kg - 13lbs
 -  800100

LAURA KIRAR



120 Dining Table

606522 Java
606532 Driftwood
Ø 120cm - 47 1/4"
T 77cm - 30 1/4"
⚖ 32kg - 70lbs
⚙ 4VE30C
Clear glass top



150 Dining Table

606524 Java
606534 Driftwood (p. 130)
Ø 155cm - 61"
T 77cm - 30 1/4"
⚖ 41kg - 90lbs
⚙ 4SA30C
Clear glass top



Armchair

606351 Java (p. 120)
606361 Driftwood (p. 124)
T 79cm - 31"
H 83cm - 32 3/4"
D 93cm - 36 1/2"
⚖ 11kg - 24lbs



Ottoman

606350 Java
606360 Driftwood (p. 125)
T 63cm - 24 3/4"
H 45cm - 17 3/4"
D 72cm - 28 1/4"
⚖ 6.5kg - 14lbs



Three Seat Settee

606353 Java
606363 Driftwood (p. 126)
T 195cm - 76 3/4"
H 83cm - 32 3/4"
D 93cm - 36 1/2"
⚖ 26.5kg - 58lbs



100 Coffee Table

606650 Java (p. 122)
606660 Driftwood
Ø 110cm - 43 1/4"
T 39cm - 15 3/4"
⚖ 20kg - 44lbs
Clear glass top



150 Coffee Table

606651 Java
606661 Driftwood (p. 126)
T 150cm - 59"
H 40cm - 15 3/4"
D 77cm - 30 1/4"
⚖ 25kg - 55lbs
Clear glass top



Tête à Tête

606700 Java (p. 137)
606750 Driftwood
T 217cm - 85 1/2"
H 69cm - 27 1/4"
D 117cm - 46"
⚖ 46kg - 101lbs

material selection
furniture covers
inscriptions

security
product care
faqs

cushions

We manufacture our cushions using Sunbrella® fabric, made from a durable, 100% solution dyed acrylic fibre that is very colour fast in sunlight. A stain repellent is applied to the fabric, although it will withstand vigorous cleaning if necessary.

Our cushions have a water repellent finish but are not waterproof and should not be left out in heavy rain. If cushions become saturated, then place them on one edge and allow the water to drain away until they are thoroughly dry. Do not store cushions when they are wet.

USA only: COM and other colours to special order. Cushion colours depicted may be different in the USA.

stock colours



.5446 Forest Green

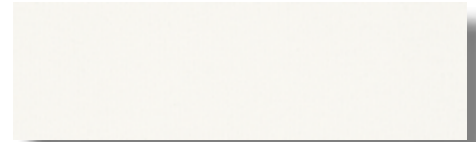

.5404 White Sand

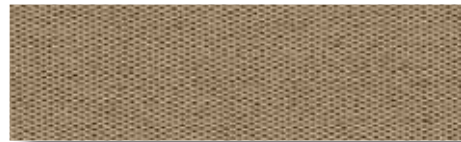

.5476 Pepper

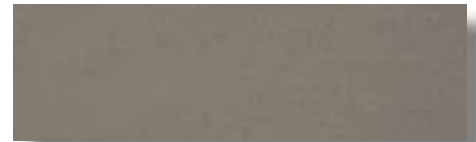

.3729 Taupe

optional colours



.5439 Classic Blue

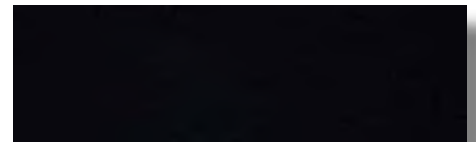

.5408 Black

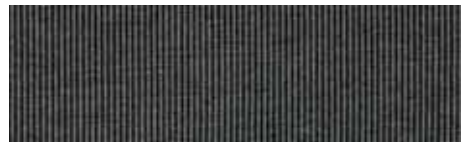

.3705 Charcoal



.5470 Walnut



.5424 Sky Blue



.5629 Sky Blue Stripe



.3738 Macaw



.3747 Macaw Stripe



.3728 Paris Red



.3756 Lead Chiné



.3778 Quadri Grey

cushions

Ref.	Cushion Type	To fit the following products	5446	5404	5476	3729	5408	3705	5470	5439	5424	5429	3778	3756	3728	3738	3747	8019	8053	
800001	Armchair	1FEA, 1GLA, 1LOA, 1MOA, 1WAA	■	■	■	■	○	○	○	○	○	○	○	○	○	○	○	○	○	
800002	Hi-Back Chair	1ASR, 1COC, 1NER	■	■	■	■	○	○	○	○	○	○	○	○	○	○	○	○	○	
800003	Hi-Back Chair - Seat pad	1ASR, 1COC, 1NER	■	■	■	■	○	○	○	○	○	○	○	○	○	○	○	○	○	
800004	Dining Chair	1AS, 1ASC, 1MOF, 1MOCF	■	■	■	■	○	○	○	○	○	○	○	○	○	○	○	○	○	
800005	Dining Chair - Large	1APA, 1EQ.T, 1EQA.T, 1LIA, 1MO, 1MOCH, 1MOH	■	■	■	■	○	○	○	○	○	○	○	○	○	○	○	○	○	
800006	Sun Loungers	1CAB, 1CAS, 1CAU, 1EQLT, 1MOL	■	■	■	■	○	○	○	○	○	○	○	○	○	○	○	○	○	
800008	Horizon Armchair	1HOAS.T	■	■	■	■	○	○	○	○	○	○	○	○	○	○	○	○	○	
800009	Avon Armchair	1AVA	■	■	■	■	○	○	○	○	○	○	○	○	○	○	○	○	○	
800012	120cm Seat	1FE12, 1MO12, 1WA12	■	■	■	■	○	○	○	○	○	○	○	○	○	○	○	○	○	
800015	150cm Seat	1FE15, 1GL15, 1LO15, 1MO15, 1WA15	■	■	■	■	○	○	○	○	○	○	○	○	○	○	○	○	○	
800018	180cm Seat	1GL18, 1LO18	■	■	■	■	○	○	○	○	○	○	○	○	○	○	○	○	○	
800056	Savannah Armchair	603100	○	■	○	○	○	○	○	○	○	○	○	○	○	○	○	○	○	
800064	Savannah Side Chair	603171	○	■	○	○	○	○	○	○	○	○	○	○	○	○	○	○	○	
800062	Savannah Sun Lounger	603470	○	■	○	○	○	○	○	○	○	○	○	○	○	○	○	○	○	
800066	Steamer Chair	1CO	■	■	■	■	○	○	○	○	○	○	○	○	○	○	○	○	○	
800067	Steamer Chair	1CO67W	■	■	■	■	○	○	○	○	○	○	○	○	○	○	○	○	○	
800080	Nevada Armchair	605100	○	■	○	○	○	○	○	○	○	○	○	○	○	○	○	○	○	
800087	Armchair Slip Over Cushion	1APA, 1LIA	○	■	○	○	○	○	○	○	○	○	■	■	○	○	○	○	○	
800100	Kirar Dining Armchair	606351	○	○	○	○	○	○	5470	5439	○	○	○	○	○	○	○	■	■	
800041	Ascot Footstool	1ASFS	■	■	■	■	○	○	○	○	○	○	○	○	○	○	○	○	○	
800007	Lumbar Cushion 51 x 20cm	All	■	■	■	■	○	○	○	○	○	○	○	○	○	○	○	○	○	
800050	Scatter Cushion 50 x 50cm	All	■	■	■	■	○	○	○	○	○	○	○	○	○	○	○	○	○	
800060	Scatter Cushion 60 x 60cm	All	■	■	■	■	○	○	○	○	○	○	○	○	○	○	○	○	○	
800070	Scatter Cushion 70 x 70cm	All	■	■	■	■	○	○	○	○	○	○	○	○	○	○	○	○	○	
Arizona Collection		601351, 601361, 601356, 601366, 601355, 601365, 601354, 601364, 601357, 601367, 601350, 601360, 6013521, 601362	○	■	○	○	○	○	○	○	○	○	○	○	○	○	○	○	○	
Dune Collection		602700, 602750, 602351, 602361, 602352, 602362	○	■	○	○	○	○	○	○	■	■	○	○	○	○	○	○	○	
Equinox Deep Seating Collection		1EQDA, 1EQD2, 1EQD3, 1EQDO	○	○	○	○	○	■	○	○	○	○	○	○	○	○	○	○	○	
Haven Deep Seating Collection		1HADA, 1HADMM, 1HADML, 1HADMR, 1HADMC, 1HALA, 1HAO	○	■	■	○	○	○	○	○	○	○	○	○	○	○	○	○	○	
Kirar Collection		606100, 606110, 606350, 606351, 606353, 606360, 606361, 606363, 606470, 606480, 606524, 606534, 606651, 606661, 606700, 606750	○	○	○	○	○	○	○	○	○	○	○	○	○	○	○	○	■	■
Linear Deep Seating Collection		1LIDA, 1LID2, 1LID3, 1LIDO,	○	■	○	○	○	○	○	○	○	○	○	○	○	○	○	○	○	
Mercury Deep Seating Collection		1MEDAC, 1MEDO, 1MEDL, 1MEDR, 1MEDC, 1MEDM				■														
Mission Collection		1MIA, 1MIFS	○	■	■	○	○	○	○	○	○	○	○	○	○	○	○	○	○	
Nevada Deep Seating Collection		605351, 605353, 605470	○	■	○	■	○	○	○	○	○	○	○	○	○	○	○	○	○	
Savannah Collection		603352, 603353, 603351, 603350	○	■	○	○	○	○	○	○	○	○	○	○	○	○	○	○	○	

■ Stock Colours ○ Optional Colours
Please allow five weeks delivery for Optional Colours

parasols

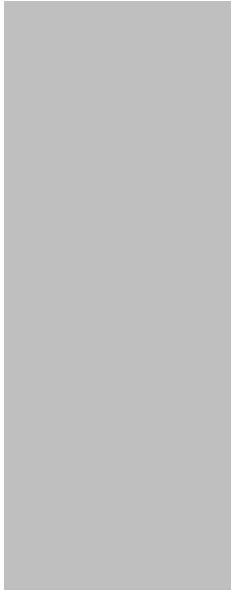

Parasol canopy fabrics are made from solution-dyed acrylic yarn, with the colour locked deep inside the yarn to give excellent resistance to the fading often caused by sunlight and cleaning. A stain repellent has been to the fabric to make cleaning easier.



.300 Forest Green



.306 Oyster .301 Ivory (Sail only)



.308 Black (Special order only in USA)

pavilions

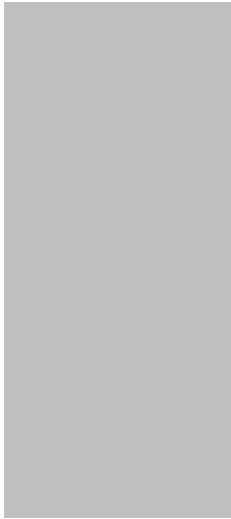

The Pavilion roof and full curtains are made from Sunbrella®100% solution-dyed acrylic yarn, with the colour locked deep inside the yarn to give excellent resistance to the fading often caused by sunlight and cleaning.



.1275 Stone



.4781 Chocolate



.4642 Oyster

slings

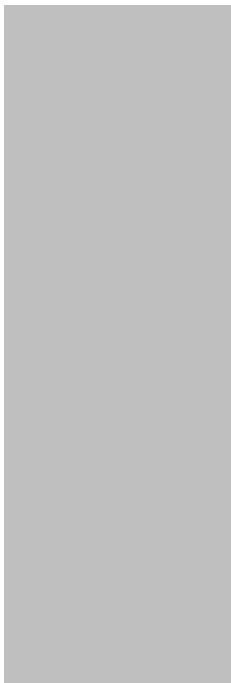

The slings on our furniture are made from Textilene®, which is woven from PVC coated polyester non-stretch yarn. This material guarantees our slings are strong, durable, and mildew resistant requiring the minimum of maintenance.

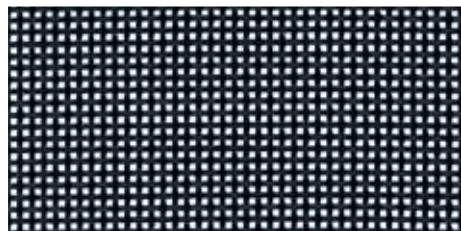

.500 Charcoal (Aura, Equinox, Horizon, Mercury, Quattro)



.505 Pearl (Aura, Equinox, Horizon, Mercury, Quattro)



.502 Titanium (Aura, Equinox, Horizon, Mercury, Quattro)

slings

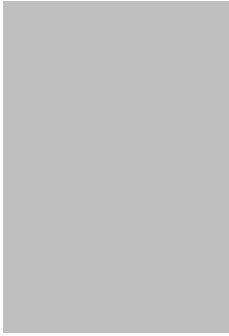

.504 Platinum
(Aura, Equinox, Horizon, Mercury, Quattro)

aluminium

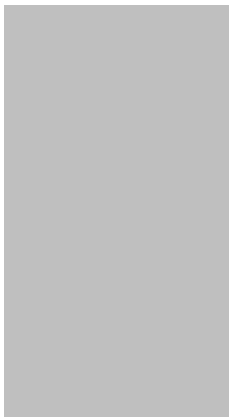

For our aluminium furniture we use what is known as 'virgin aluminium'. We chemically clean each item and then powder-coat the aluminium to prevent oxidation and to ensure it gives long service.



.01 Graphite
Frames: Aura
Arm Inserts: Equinox, Mercury, Quattro



.02 Arctic White
Frames: Aura
Arm Inserts: Equinox, Mercury, Quattro

woven

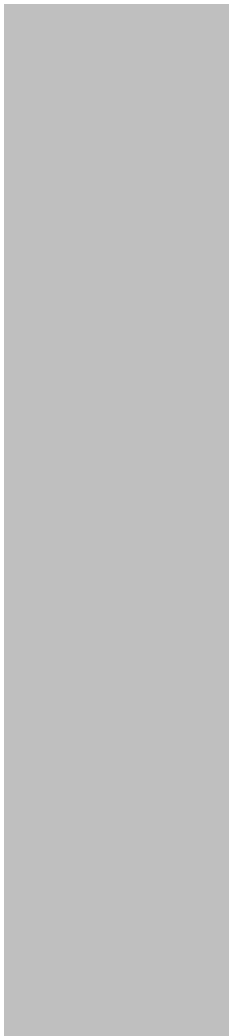

We use a synthetic fibre that is colour fast, exceptionally strong and completely resistant to sun, rain and requires the minimum of maintenance.



Java - Flat (Savannah)



Cinnamon (Nevada)



Sahara (Arizona)



Java (Arizona)



Java - Round (Dune)



Straw (Dune)

woven

kirar collection

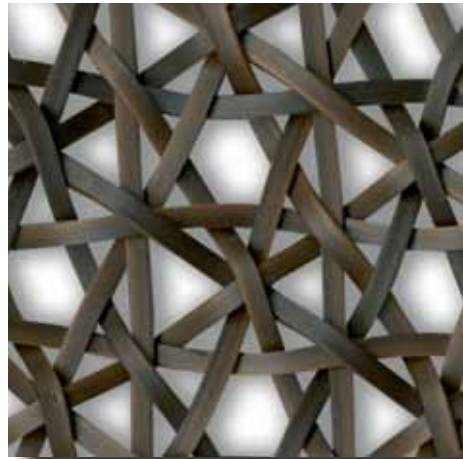

Java - Outer weave (*Kirar Collection*)

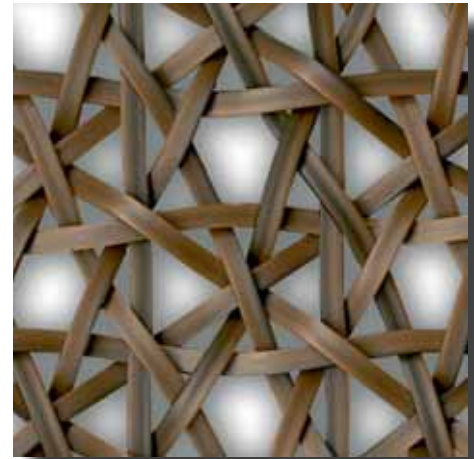

Java - Inner weave (*Kirar Collection*)

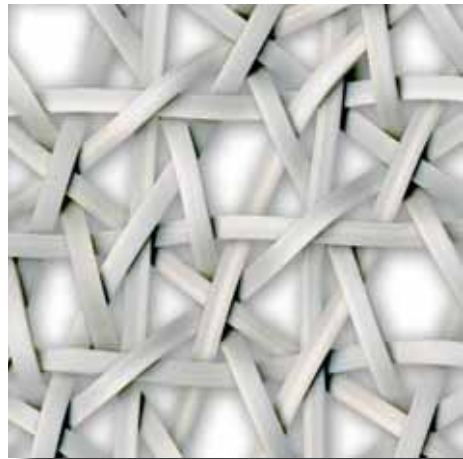

Driftwood - Outer weave (*Kirar Collection*)

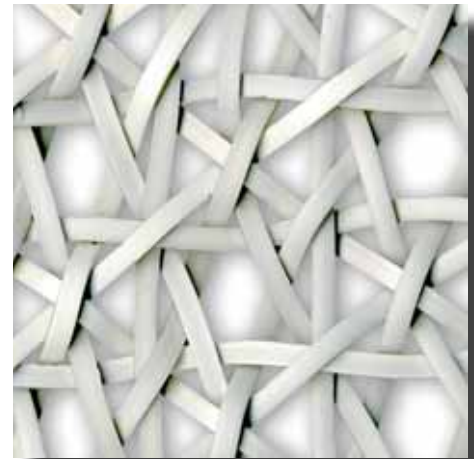

Driftwood - Inner weave (*Kirar Collection*)

stock colours

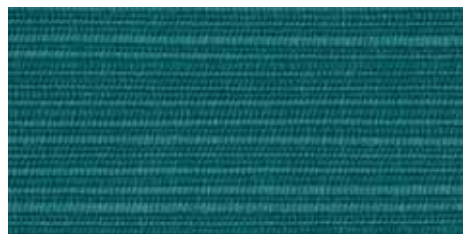

.8019 Deep Sea (*Kirar Collection*)



.8053 Papaya (*Kirar Collection*)

table tops

glass

Although made to withstand the rigours of an outdoor environment, your furniture will benefit from regular care and maintenance. For each type of our furniture, we produce a care product that is easy to use and will help maintain its 'just bought' look. Normally, you will need to treat your furniture only once or twice a year, dependent upon location.

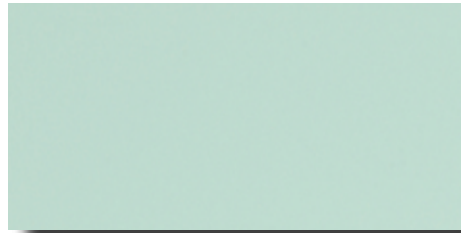

.604 Sea Ice (Mercury)

Our Mercury dining table tops are made from clear tempered glass with the colour applied to the under surface with a hard wearing ceramic paint. The top surface has been acid etched and sand blasted to achieve a luxurious tactile matt surface.



.605 Platinum (Mercury)

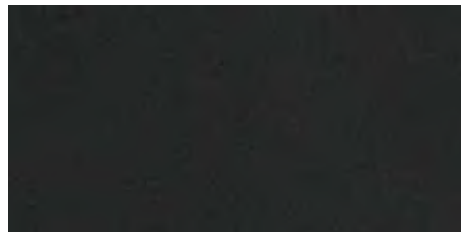

.606 Charcoal (Mercury)

high pressure laminate (HPL)

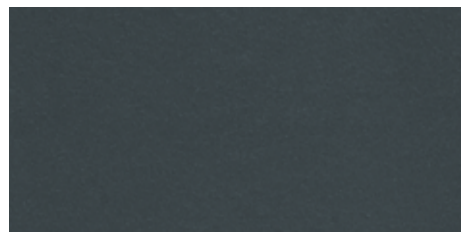

.700 Slate Grey (Equinox, Mercury)

Our HPL (High Pressure Laminate) table tops are unaffected by rain, sun, mould or rot. They have high colour stability and are UV resistant. The surface has a smooth, wipe clean finish that ensures dirt does not accumulate.

ceramic



Grey (2MES Mercury Serving Table only)

The Laminam ceramic we use is weather resistant, has high colour stability, wipe clean finish and is scratch proof. The ideal outdoor work surface.

covers

These lightweight, one way breathable covers allow trapped moisture to disperse, but prevent rain and dust from penetrating. A unique fastening ensures a secure fit. The covers are easy to put on, remove and can be stored in their own pouch when not required.



Code	Description	To Fit
Arizona Range Covers		
400101	Arizona Armchair	601351, 601361
400102	Arizona 2 Seater combination	601354 + 601355, 601364 + 601365
400103	Arizona 3 Seater combination	601354 + 601357 + 601355, 601364 + 601367 + 601365
400782	Arizona Large Ottoman	601350, 601360
400118	Arizona End Table	601652, 601662
400130	Arizona 75cm Coffee Table	601650, 601660
400147	Arizona 120cm Coffee Table	601651, 601661
Dune Range Covers		
400700	Dune Daybed and Ottoman	602700, 602750
400701	Dune Deep Seating Armchair	602351, 602361
400702	Dune Deep Seating 2 Seater	602352, 602362
400781	Circular Conversation Table	602650, 602660
Nevada Range Covers		
400501	Nevada Deep Seating Armchair	605351
400503	Nevada Deep Seating 3 Seater	605353
High Back Deep Seating Covers		
400721	High Back Deep Seating Armchair	603351, 1ADA, 1HADA, 1MIA
400722	High Back Deep Seating 2 Seater	603352
400723	High Back Deep Seating 3 Seater	603353
Sun Lounger Covers		
400731	Sun Loungers	All Sun Loungers
Standard Deep Seating Covers		
400741	Standard Height Deep Seating Armchair	1EQDA
400742	Standard Height Deep Seating 2 Seater	1EQD2, 1HADML + 1HADMR
400743	Standard Height Deep Seating 3 Seater	1EQD3, 1HADML + 1HADMM + 1HADMR
400130	Deep Seating Ottoman	1EQDO
Standard Dining Group Covers		
400751	90cm to 120cm Table and 4 Chairs	2AU09, 2ED09, 2EQ09.700, 2EQC10, 2AR09, 2EQ10, 2BA11, 2BA13, 2ECC12, 2MEC12, 2QU10, 603522
400752	90cm Circular High Dining and 4 Chairs	2EDH09, 2EQCH10
400754	150cm to 180cm Circular Table and 8 Chairs	2DR15, 2EQC15S, 2EQC18.700, 2EQC15.700, 2HOC15, 2HOC18, 2WIC15, 603524, 2DR18, 2EQC18S
400765	150cm Rectangular Table and 6 Chairs	2AU15, 2AR13, 2ME15T, 2MO15, 2WI15, 2EQ15, 2EQ15.700, 2EQX23 (closed), 2LP16
400766	200cm Rectangular Table and 6 - 8 Chairs	2AU20, 2AR18, 2ARX28 (closed), 2EQ15.700, 2EQ20.700, 2EQ22, 2ST20, 2EC20, 2ME22, 2QU20, 603565, 604565
400767	320cm Rectangular Table and 8 - 10 Chairs	2STX32 (closed)
400768	Apex Extending Table and 14 Chairs	2APX39
Accessory Covers		
400770	Serving Table and Trolley	2CR, 2EQS, 2MES, 2MIS
400772	Small Storage Chest	3SC11
400773	Large Storage Chest	3SC15
400774	Reims Refreshment Chest	3RE
Conversation/Coffee Tables		
400781	Circular Conversation Table	602650, 602660, 2EQCC10, 2HACC10
400782	Square Conversation Table	2EQSC10, 2HASC10
400783	Small Rectangular Coffee Table	603650, 2EQL10, 2MOL, 2MOL10
400784	Large Rectangular Coffee Table	603651

inscriptions



The Barlow Tyrie inscription service may be used with most of our teak Armchairs and Seats. The inscription is normally on the front of the top rail.



The carving is in a traditional serif typeface using a 'V' shaped cut, which allows the inscription to be easily read from the side as well as from immediately in front. A 'straight' cut letter does not have this advantage.

As an alternative to carved inscriptions we also offer Bronze Plaques with lettering set in cream vitreous enamel. The finished plaque is then recessed into the face of the rail and held in position using a special hidden vandal proof fitting.

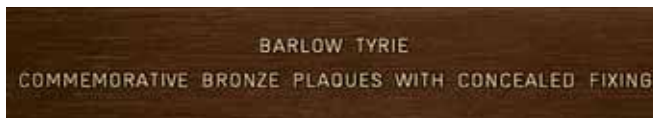

security



A set of four polished brass seat security fasteners to prevent unauthorised movements of seats in public areas. Supplied with tamper proof fixings for concrete, paving and wood.



Galvanised seat security fasteners for setting into concrete for all teak seat models to prevent unauthorised movements of seats in public areas.

product care

Although made to withstand the rigours of an outdoor environment, your furniture will benefit from regular care and maintenance. For each type of our furniture, we produce a care product that is easy to use and will help maintain its 'just bought' look. Normally, you will need to treat your furniture only once or twice a year, dependent upon location.

However, harsher environments such as coastal or chlorinated pool areas may need more frequent maintenance. Spotting on the surface, which appears to be rust, may occur, although unsightly, you can easily remove any contamination with "Barlow Tyrie Stainless Steel Clean and Guard", which cleans the stainless steel and leaves a fine layer of Teflon® on the surface to help prevent the build up of contaminants.

Stainless Steel Clean & Guard



Ref. 4SSCG
Cleans stainless steel and leaves a fine layer of Teflon on the surface to help prevent the build up of contaminants. Supplied with its own special applicator pad.

Contains 1litre/33oz

Teak Cleaner



Ref. 4TC
Cleans and restores discoloured, dark grey teak. Contains brightener ingredients which will restore your teak to its original colour. Supplied with its own special applicator pad.

Contains 1litre/33oz

Powder Coated Aluminium Cleaner



Ref. 4AC
Easily removes dirt and grease, oil, pollutants and mould from the furniture. Supplied with its own special applicator pad.

Contains 1litre/33oz

Teak Stain Guard



Ref. 4TSG
Forms an invisible layer to protect your teak from everyday stains such as butter, oil and red wine, making the cleaning of accidental spills an easy task. Supplied with its own special applicator pad.

Contains 1litre/33oz

Textilene & Woven Non Foam Cleaner



Ref. 4WTC
A non foaming cleaner that maintains woven furniture and Textilene® without unsightly residue remaining after the cleaning process. Supplied with its own special applicator pad.

Contains 1litre/33oz

Teak Colour Guard



Ref. 4TCG
Maintains the golden brown colour of new teak. Supplied with its own special applicator pad.

Contains 1litre/33oz

Fabric Cleaner



Ref. 4FC
Removes dirt and grease, oil, pollutants and mould from our cushions. Supplied with its own special applicator pad.

Contains 1litre/33oz

Teak Oil



Ref. 4TO
Traditional method of retaining original colour of new teak.

Contains 500ml/16oz

Fabric Weather Guard



Ref. 4FWG
Protects the fabric and slows down the aging effects of weathering. Supplied with its own special applicator pad.

Contains 1litre/33oz

Anti Wasp Solution



Ref. 4WS
Deters wasps from defacing the surface of weathered wood.

Contains 1litre/33oz

Note: Not available in the USA

Which materials does Barlow Tyrie use?

We combine the highest quality materials with superior craftsmanship and design to produce our furniture, resulting in worldwide recognition of our brand as representing the best in outdoor furniture. To our renowned range of the highest grade teak furniture we have now added Textilene®, stainless steel, aluminium and synthetic woven materials, to produce contemporary designs to the same high standard.

Teak
What are the properties of teak?

Teak is a deciduous hardwood tree from managed plantations, it does not come from tropical rainforests. Teak has a naturally high oil content which makes it both stable and resistant to rotting when exposed to climatic extremes. For centuries these special qualities have made teak the preferred choice for marine decking and construction, hence it is considered the premium timber for outdoor furniture.

What is the Forest Stewardship Council (FSC®) ?

The Forest Stewardship Council is an international, non-profit association whose members include environmental, social groups, progressive forestry and timber related companies who are working together in order to improve forest management world-wide. The trademark of the FSC on a product indicates that the wood used to make it comes from a source that has been certified by the FSC as being well managed and meeting the environmental, social and economic standards that have been set by the FSC. The FSC certificate is only granted to organisations following an annual audit to confirm their compliance with FSC standards. Our audit is performed by an FSC accredited audit organisation called Smartwood and our Chain of Custody code is SW-COC-000090 .

Does Barlow Tyrie produce any FSC® certified furniture ?

Yes. Selected products displayed in store and held in stock are FSC certified, as are the stocks held at Barlow Tyrie on the behalf of John Lewis. Other products, which may be ordered from the Barlow Tyrie range may not be FSC certified.

What is the teak weathering process ?

Over a period of time in an outdoor environment teak will weather to a beautiful silver grey. The length of time this takes will vary with exposure to different climatic conditions.

Why do occasional cracks appear on my furniture ?

Teak is a natural material and as such fine cracks in the end grain of components, e.g. legs and arms, may appear and then disappear with variations in the weather and the consequent change in the moisture content of the wood. Such fine cracks are normal, especially in heavier components, and will not affect the life or serviceability of your furniture.

Do I need to store my furniture during the winter ?

No, Barlow Tyrie teak furniture can be left outdoors, uncovered, all year round. If you choose to cover your furniture outdoors during the winter you should use a material that allows the wood to breathe.

Stainless Steel
What are the properties of stainless steel?

We use two grades of stainless steel; 316 Grade, commonly known as 'marine grade' and 304 Grade, the most commonly used for garden furniture. 316 and 304 grades are both suitable for use in inland locations, but 316 grade is suited for most coastal areas and marine environments. 304 and 316 grade should not be used in heavily chlorinated indoor environments.

If you have any questions or concerns about which grade is best suited for your area, please contact customer service.

We recommend the following Barlow Tyrie product to care for and maintain your Stainless Steel furniture

- *Stainless Steel Clean & Guard*
 Cleans stainless steel and leaves a fine layer of Teflon on the surface to help prevent the build up of contaminants.

Aluminium
What are the properties of aluminium?

Aluminium is lightweight and for this reason, we have included it in our range. The aluminium we use is 'Virgin Aluminium', meaning it is not reclaimed from scrap, making it stronger and longer lasting. We powder-coat the aluminium to prevent oxidation and ensure it gives long service. We recommend the following Barlow Tyrie product to care for and maintain your Aluminium furniture

- *Powder Coated Aluminium Cleaner*
 Easily removes dirt, grease, oil, pollutants and mould.

Care of teak
How do you clean teak?

Teakwood will naturally weather from golden brown to a silver grey colour. We recommend the following range of our Barlow Tyrie products to care for and maintain your Teak furniture.

- *Teak Cleaner*
 Will quickly remove accumulated dirt
- *Teak Colour Guard*
 Will maintain the golden brown colour of new teak by using UV inhibitors to prevent the natural greying process and pigment enhancers to help maintain the natural colour of teak.
- *Teak Stain Guard*
 Forms an invisible layer to protect your teak from everyday stains such as butter, oil and red wine, making the cleaning of accidental spills an easy task.

If you live in the UK and wish to maintain your furniture using our care products, but do not wish to do the work yourself, then we recommend you contact www.teakcare.co.uk who can provide a regular or one time service according to your needs

Do I need to oil my teak furniture?

Treating with teak oil or other preservatives is not necessary, it will not extend the life of your furniture and is purely cosmetic. We do not recommend oiling your furniture.

Will the metal fittings on my furniture last as long as the teak?

We only use the best marine quality solid brass and stainless steel on our furniture. Neither of these will rust nor deteriorate with age.

Do I need to use a base if I am locating a parasol through a dining table?

Yes, all parasols must be located in the recommended parasol base for safety reasons. We supply our standard parasol base for when you wish to use a parasol through a dining table, a free standing base is available for use without a table. Standard parasol plates are available for when a parasol is required for the Equinox Pedestal Tables.

Can we use any of your chairs with any of your tables?

Our dining chairs and tables are made to a standard that gives the correct distance between the seat and the table top, which ensures you are comfortable when eating. You can confidently purchase any of our chairs with any of our tables depending on your design preference and the number of people you wish to seat.



© Copyright Barlow Tyrie Limited

1EQA.504 2EQ10 4VE30C.306

All copyrights are owned by Barlow Tyrie Limited, any infringement of our copyright by any party will be actively pursued.

The Barlow Tyrie logo and Elephant design are Registered Trade Marks of Barlow Tyrie Limited.

Whilst great care is taken to reproduce the fabric colours as accurately as possible, it should be noted that due to the limitations of the printing process, the colours illustrated should only be used as a guide.

Barlow Tyrie Limited reserves the right to alter specifications without notice.

Product dimensions and weights are approximate.

This publication has been designed and produced by Barlow Tyrie Limited.

Photography: The Photographic Workshop
Pre Press: Zebra
Printed by: Körner Rotationsdruck



available worldwide



Barlow Tyrie Limited
Braintree
Essex CM7 2RN England
t: + 44 (0)1376 557 600
f: + 44 (0)870 460 1100

Barlow Tyrie Inc
1263 Glen Avenue Suite 230
Moorestown
NJ 08057 - 8101 USA
t: + 1 856 273 7878
f: + 1 856 273 9199

www.teak.com

