

# NIGHT COLLECTION

FELIS EXPERIENCE SINCE 1990

# STORIES



**EXPERIENCE 25** - Felis lavora gli imbottiti da 25 anni ...esperienza ...tradizione ...conoscenza ...manualità vera a integrare la precisione delle lavorazioni

**Design per ogni ambiente** - Dal design, al moderno alla citazione e alla rilettura delle forme più classiche

**Anima artigiana** - Artigianato tessile per le impunture, le doppie cuciture piatte, l'effetto pizzicato, la rilettura del capitoné, i bordi a rilievo, i volant... lavorazioni sartoriali, particolari veri, dettagli di stile

**Specializzazione** - Felis è uno specialista dei rivestimenti in tessuto, con una particolare attenzione verso i filati, le trame e i disegni per una gamma attuale e di tendenza oggi e domani... un piacere per la vista, il tatto per portare eleganza nella morbidezza del comfort...

**Una personalizzazione spinta** Programmi letto che consentono ampi interventi di personalizzazione per altezza, piedini, tessuti, lavorazioni, optional, accessori...

**Idee, soluzioni tecniche, tecnologie** Lo schienale amovibile per una posizione più eretta, lo scomparto segreto... la luce incorporata, il caricabatterie e il portariviste, la panquette e il pouf. E tanti meccanismi brevettati per facilitare l'accesso ai contenitori, la movimentazione e la pulizia

**Tutti sfoderabili e rifiniti davanti e dietro** - tutti i programmi di letto di Felis sono totalmente sfoderabili, testiera, cuscini, giroletto... facilmente, con semplicità e senza sforzo. Molte delle testiere poi... rifinite allo stesso modo davanti e dietro... possono essere utilizzate successivamente e indifferentemente dai due lati se vuoi cambiare verso e avere la tua **testiera** sempre al meglio... perchè il tuo letto Felis deve essere sempre perfetto...

**EXPERIENCE 25** - Felis has manufactured upholstered furniture for 25 years ...experience ...tradition ...knowledge ...true dexterity integrating the precision of the machines

**Design for each environment** - From modern design, to references and reinterpretation of classic forms

**Artisan soul** - Textile craftsmanship in the stitching, the double flat seams, the pinched effect, the reinterpretation of the quilted effect, the edges in relief, the frills... special tailoring true details style details

**Expertise** - Felis is an expert in fabric upholstery, with particular attention to yarns, textures and designs for a current line that is trendy today and tomorrow... a pleasure for your eyes and feel, to bring elegance in the softness of comfort...

**High customization** - Programs for beds that allow high customization as regards height, feet, fabrics, processing, optional features, accessories...

**Ideas, technical solutions, technologies** The removable backrest for a more upright position, the secret compartment... the built-in light.. the charger and the magazine rack the benches and the ottomans AND many patented mechanisms to facilitate access to the containers, handling, and cleaning.

**All removable and finished on front and back** - all programs for beds by Felis are totally removable. headboard, pillows, bed frames... easily, simply, and effortlessly Many of the headboards are also finished the same way on front and back... they can be used later and interchangeably on both sides if you want to change direction and have your headboard always at best... because your Felis bed must always be perfect...

**EXPÉRIENCE 25** - spécialiste des meubles rembourrés depuis 25 ans ...expérience ...tradition ...connaissance ...professionnalisme et précision des réalisations

**Design pour chaque pièce** - Du design, au moderne au rappel et à la relecture des forme plus classiques

**Âme artisanale** - L'artisanat textile des surpiques, des doubles coutures plates, l'effet pincé, la relecture du capitoné, les bords en relief, les volants... des réalisations haute couture et des détails de style

**Spécialisation** - Felis est le spécialiste des revêtements en tissu, avec une attention toute particulière aux tissus, aux trames et aux dessins pour créer une gamme actuelle et tendance aujourd'hui et demain... un plaisir pour les yeux, le toucher, qui apporte de l'élégance au moelleux du confort...

**Une personnalisation poussée** Des lits qui permettent une personnalisation maximale en ce qui concerne la hauteur, les pieds, les tissus, la réalisation, les options, les accessoires...

**Idées, solutions techniques, technologies** - Un dossier amovible pour une position plus droite, un compartiment secret...la lumière incorporée. le chargeur et le porte-revues les bancs et le pouf E des mécanismes brevetés pour faciliter l'accès aux coffres de rangement, le déplacement et le nettoyage

**Tous déboussables et avec finition devant et derrière** - tous les lits Felis sont entièrement déboussables. tête de lit, coussins, cadre de lit...facilement, avec simplicité et sans effort de nombreuses têtes de lit puis...finitions devant et derrière. des deux côtés peuvent être utilisées successivement et indifféremment pour changer et avoir une tête de lit toujours parfaite... parce qu'un lit Felis doit toujours être parfait...

## Sommario | Summary | Résumé

Adrian	262	Kevin	22	Panquette	370
Allen	88	Lenny	6	Pouf	368
Charles	304	Luis	232		
Chris	114	Miller	252		
Clyde	296	Nelson	172		
Damian	208	Oliver	14	Optional	374
Dennis	280	Oscar	154	Relax System / USB	376
Edgar	58	Parker	290	Piedi / Feet / Pieds	378
Emily	180	Patrick	188	Le reti / Supports / Les sommiers	380
Erik	350	Penny	66	Meccanismi / Mechanisms / Mécanisme	382
George	242	Rick	164		
Hamilton	78	Ronny	272	Clean Up System	386
Henry	316	Scotty	126		
Houdini	356	Sommy	40	Regolatore rete / Springs adjuster / Réglage réseau	387
Jason	146	Sommier	322		
Jerry	196	Tiffany	46		
Julius	32	Tim	96		
Karl	222	Vern	134	Quality Made in Italy	388

# BEDSTORIES

Sommario | Summary | Résumé



Lenny 6



Oliver 14



Kevin 22



Julius 32



Sommy 40



Tiffany 46



Edgar 58



Penny 66



Hamilton 78



Allen 88



Tim 96



Chris 114



Scotty 126



Vern 134



Jason 146



Oscar 154



Rick 164



Nelson 172



Emily 180



Patrick 188



Jerry 196



Damian 208



Karl 222



Luis 232



George 242



Miller 252



Adrian 262



Ronny 272



Dennis 280



Parker 290



Clyde 296



Charles 304



Henry 316



Sommier 322



Erik 350



Houdini 356



Pouf 368



Panquette 370

# Lenny

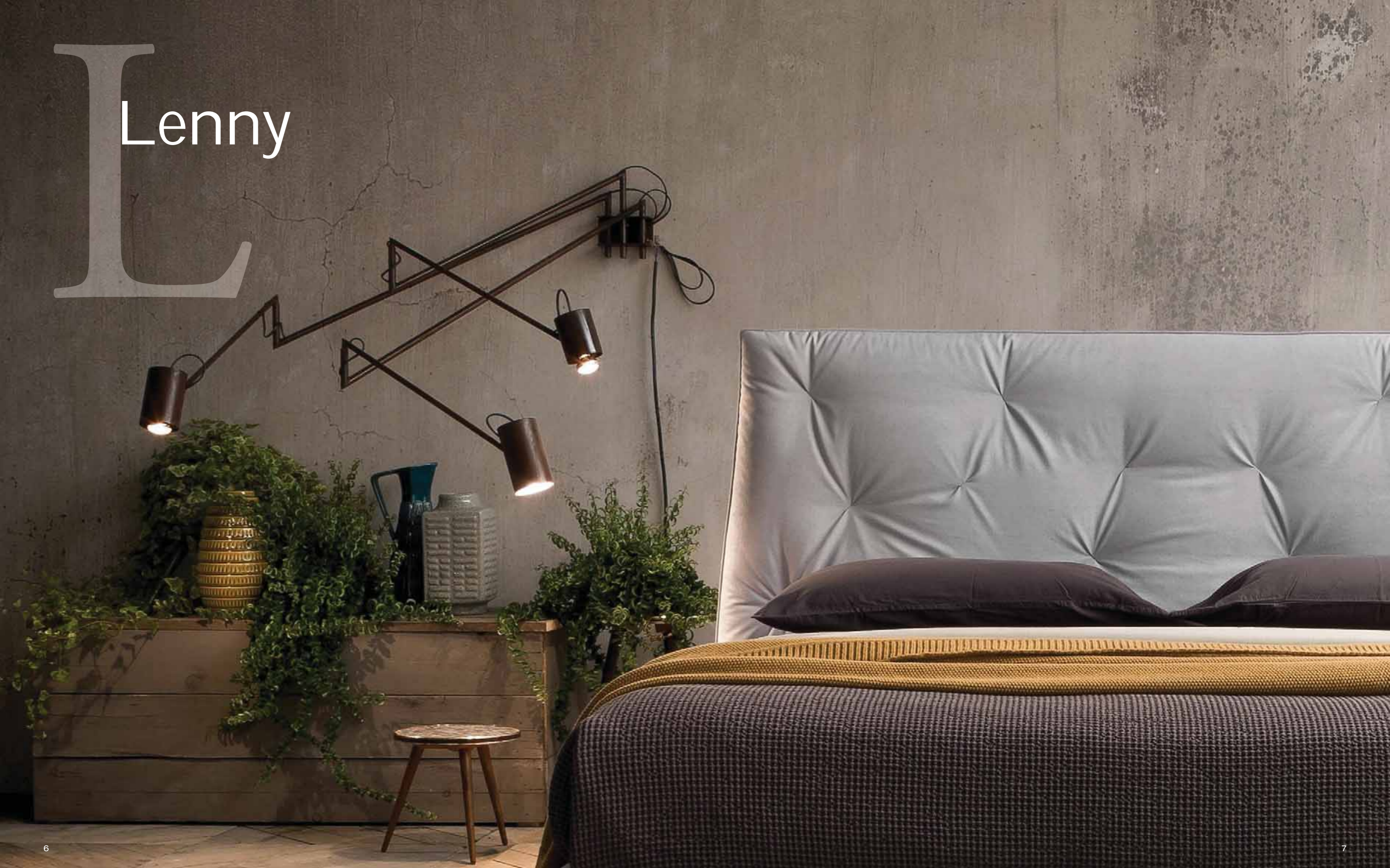



Lenny

*La testiera si allarga alla base e “contiene” il letto. Anche il giroletto si allarga verso il basso ma con una morbida evidente curva, che lo ancora al pavimento.*

*The headboard's base widens and “contains” the bed. Also the bed frame widens downwards but with a soft and evident curve, that anchors it to the floor.*

*La tête de lit s'élargit à la base et “contient” le lit. Le cadre de lit aussi s'élargit vers le bas avec une courbure à la fois souple et marquée, qui le fixe au sol.*





*Per la grande testiera  
rilettura particolare con  
effetto capitonné:  
più libero, morbido, naturale,  
scomposto, senza bottoni, senza  
geometrie e rigide simmetrie...*



*For the large headboard,  
particular reinterpretation  
with quilted effect:  
more free, soft, natural,  
decomposed, without buttons,  
without rigid geometries and  
symmetries...*

*Pour la grande tête de lit  
nous proposons une relecture  
particulière avec effet  
capitonné:  
plus libre, moelleuse, naturel,  
décomposée, sans boutons, sans  
géométrie et salis symétries  
rigides...*

## Lenny

Completamente sfoderabile  
Totally removable cover  
Complètement déhoussable

\*  
Rete L. 180 cm  
solo profondità 200 cm  
Support W. 180 cm  
only D 200 cm  
Sommier L. 180 cm  
uniquement en  
profondeur 200 cm

**Caratteristiche tecniche**  
**Masselli** in legno di abete e/o  
scatolati in multistrato di legno di  
pioppo. **Pannelli** da 18/25 mm  
in particelle di legno di pioppo  
in classe E1 a bassa emissione  
di formaldeide e fibra di legno  
naturale. **Espansi** di poliuretano  
indeformabile a portanza  
differenziata, densità da 18 kg/  
mc a 40 kg/mc.  
**Primo rivestimento** in espanso  
di poliestere accoppiato a caldo  
a vellutino aggrappante in  
poliestere e/o ovatta di poliestere  
al 100% da 200gr. **Pannelli  
fondo** contenitore da 12-14 mm  
in particelle di legno di pioppo in  
classe E1.

**Technical characteristics**  
**Forgings** fir wood, and/or boxed  
in poplar plywood. **Panels** 18/25  
mm in poplar wood particles  
class E1 low formaldehyde  
emission and natural wood fiber.  
**Polyurethane foam**, crushproof,  
of different capacity, density from  
18 kg/mc to 40 kg/mc.  
**First coating** hot bonded  
polyester foam, velvet adhesion  
in polyester and/or 100%  
polyester wool, 200gr. **Container  
bottom panels** 12-14 mm in  
poplar wood particles class E1.

**Caractéristiques techniques**  
**Tige** en pin et/ou boitiers en  
multicouche en bois de peuplier.  
**Panneaux** de 18/25 mm en  
particules de bois de peuplier  
classe E1 à faible émission  
de formaldéhyde et fibre de  
bois naturelle. **Polyuréthane  
expansé** indéformable à portée  
différenciée. densité de 18kg/m<sup>2</sup>  
à 40kg/m<sup>2</sup>.  
**Premier revêtement** en  
polyester expansé accouplé à  
chaud à un velours accrochant  
en polyester et/ou ouate de  
polyester à 100% de 200g.  
**Panneaux de fond coffre**  
rangement de 12-14mm en  
particules de bois de peuplier  
classe E1.

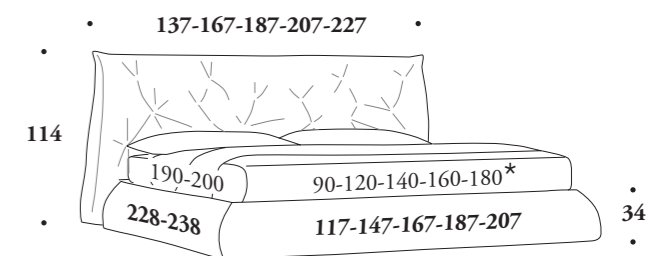

## Ring Round



Standard  
Basic  
H 3 cm

wengé  
wengé  
wengé

Varianti colore / Color variants / Couleurs disponibles

nero  
black  
noir

bianco  
white  
blanc

argento  
silver  
argent

Optional  
Lux  
H 3 cm

wengé  
wengé  
wengé

nero  
black  
noir

bianco  
white  
blanc

cromo  
chrome  
chrome

Optional  
Accessori  
Accessoires  
Accessoires

Panquette  
Panquette  
Panquette



p. 370

Pouf con  
contenitore  
Pouf with  
container  
Pouf avec  
rangement



p. 368

Sacca  
portaoggetti  
Storage bag  
Sac porte-objets



p. 375

Meccanica / Mechanism / Mécanique p. 382

Rete / Support / Sommier p. 380



Dynamic

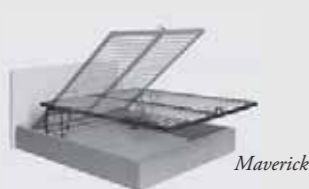

Maverick



Armony

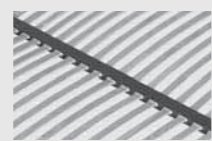

Thai  
46 doghe / slats / lattes

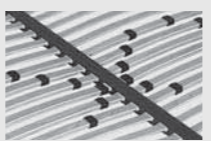

Energy  
Non applicabile a rete da 120 cm  
Not applicable to 120 cm support  
Non applicable au sommier de 120 cm

Tessuto coprirete  
traspirante antipolvere  
Support cover fabric  
breathable and dustproof  
Tissu couvre-sommier  
transpirant anti-poussière

p. 384

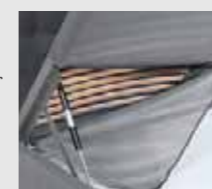

Sacco contenitore  
Multiuso  
Multipurpose  
storage bag  
Sac coffre de  
rangement multi  
usage

p. 385

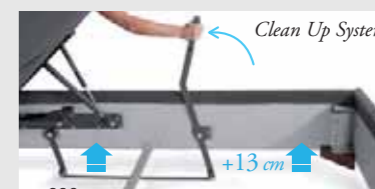

p. 386

Regolatore  
altezza rete  
Support height  
adjuster  
Réglage  
hauteur  
sommier

p. 387







Oliver





Oliver

- Relax System -

*Un design post moderno, un prodotto lineare con citazioni di lusso non ostentate.*

*I cuscini della testiera sono lineari, arricchiti da una cornice sui lati esterni che segue il profilo della testiera. Li evidenzia e li sostiene una balza arricciata in morbidi volants.*

*Il giroletto invece si accompagna alla tinta dei soffici cuscini.*

*A post-modern design, a linear product with luxurious, but not ostentatious, references.*

*The cushions of the headboard are linear and enriched by a frame on the outer sides which follows the edge of the headboard. It highlights and supports them a flounce curled in soft frills. The bed frame, on the other hand, matches the color of the fluffy pillows.*

*Un design post-moderne, un produit linéaire avec des touches de luxe, mais non ostentatoire.*

*Les coussins de la tête de lit sont linéaires et enrichis d'un bord qui encadre le profil de la tête de lit sur les côtés externes. Ils sont mis en évidence et soutenus par des volants souples. Le tour de lit est assorti à la couleur des coussins moelleux.*

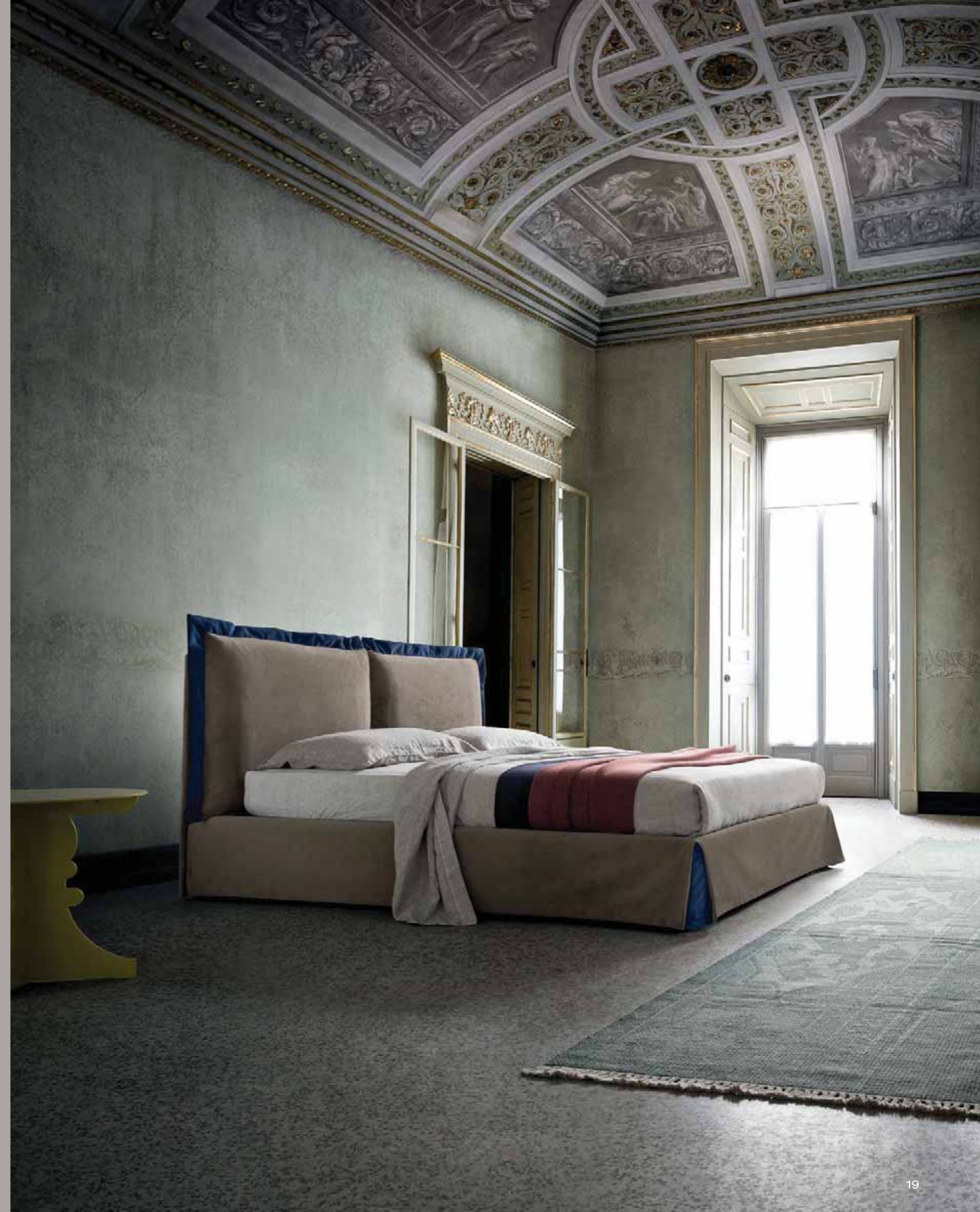

- Relax System -



### Relax System

Grazie all'innovativa soluzione dei cuscini reclinabili molte testiere sono relax system, consentono cioè una comoda posizione "seduta" e un pratico appoggio di sostegno per leggere, guardare la tv, lavorare al laptop...

### Relax System

With the innovative solution of the headboard cushions, many headboards become relaxation systems, that is, allow a comfortable position while "sitting" and a practical support for reading, watching TV, working on laptop...

### Relax System

Grâce à la solution innovante des coussins tête de lit inclinable, de nombreuses tête de lits sont « relax system », elles permettent d'avoir une position assise commode et un appui pratique pour lire, regarder la télé, travailler avec l'ordinateur portable...



Portagioie p. 376  
Jewelry Box - Porte-bijoux



Porta USB p. 377  
USB holder - Port USB



## Oliver

Completamente sfoderabile  
Totally removable cover  
Complètement déhoussable

\*  
Rete L. 180 cm  
solo profondità 200 cm  
Support W. 180 cm  
only D 200 cm  
Sommier L. 180 cm  
uniquement en  
profondeur 200 cm

### Caratteristiche tecniche

**Masselli** in legno di abete e/o sciolati in multistrato di legno di pioppo. **Pannelli** da 18/25 mm in particelle di legno di pioppo in classe E1 a bassa emissione di formaldeide e fibra di legno naturale. **Espansi** di poliuretano in densità da 18 kg/mc a 40 kg/mc. **Cuscini** rivestiti in ovatta da 300 gr. **Primo rivestimento** in espanso di poliestere accoppiato a caldo a vellutino aggrappante in poliestere e/o ovatta di poliestere al 100% da 200gr. **Pannelli fondo** contenitore da 12-14 mm in particelle di legno di pioppo in classe E1.

### Technical characteristics

**Forgings** fir wood, and/or boxed in poplar plywood. **Panels** 18/25 mm in poplar wood particles class E1 low formaldehyde emission and natural wood fiber. **Polyurethane foam** density from 18 kg/mc to 40 kg/mc. **Cushions** coated with 300 gr wadding. **First coating** hot bonded polyester foam, velvet adhesion in polyester and/or 100% polyester wool, 200gr. **Container bottom panels** 12-14 mm in poplar wood particles class E1.

### Caractéristiques techniques

**Tige** en pin et/ou boitiers en multicouche en bois de peuplier. **Panneaux** de 18/25 mm en particules de bois de peuplier classe E1 à faible émission de formaldéhyde et fibre de bois naturelle. **Polyuréthane expansé** densité de 18kg/m<sup>2</sup> à 40kg/m<sup>2</sup>. **Coussin** rembourrés avec de la ouate de 300g. **Premier revêtement** en polyester expansé accouplé à chaud à un velours accrochant en polyester et/ou ouate de polyester à 100% de 200g. **Panneaux de fond coffre** rangement de 12-14mm en particules de bois de peuplier classe E1.

• 120-150 •

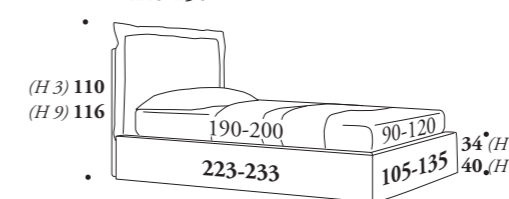

### Ring Eko



• 170-190-210 •

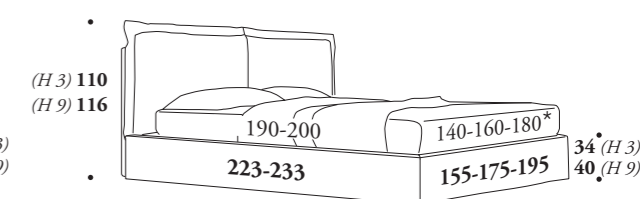

### Ring Liberty



### Standard

Basic  
H 3 cm



### Varianti colore / Color variants / Couleurs disponibles



Lux  
H 3 cm



Optional

Visual  
H 9 cm



### Optional

Accessori  
Accessoires

Panquette  
Panquette



p. 370

Pouf con  
contenitore  
Pouf with  
container  
Pouf avec  
rangement



p. 368

Sacca  
portaoggetti  
Storage bag  
Sac porte-objets



p. 375

Meccanica / Mechanism / Mécanique p. 382



20



Maverick

Rete / Support / Sommier p. 380



Armony



Thai  
46 doghe / slats / lattes

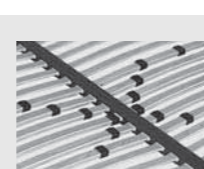

Energy  
Non applicabile a rete da 120 cm  
Not applicable to 120 cm support  
Non applicable au sommier de 120 cm

Tessuto coprirete  
traspirante antipolvere  
Support cover fabric  
breathable and dustproof  
Tissu couvre-sommier  
transpirant anti-poussière

p. 384



Sacco contenitore  
Multipurpose  
storage bag  
Sac coffre de  
rangement multi  
usage

p. 385



p. 386

Regolatore  
altezza rete  
Support height  
adjuster  
Réglage  
hauteur  
sommier

p. 387



21

# K Kevin





# Kevin





Kevin, *light lifestyle.*





**La testiera imbottita**  
 dà un effetto avvolgente e  
 protettivo e contiene i grandi  
 cuscini dal bordo in evidenza.  
 Possibilità opzionale:  
 l'illuminazione a LED  
 incorporata.

## Kevin

Completamente sfoderabile  
 Totally removable cover  
 Complètement déhoussable

\*  
 Rete L. 180 cm  
 solo profondità 200 cm  
 Support W. 180 cm  
 only D 200 cm  
 Sommier L. 180 cm  
 uniquement en  
 profondeur 200 cm

**Caratteristiche tecniche**  
**Masselli** in legno di abete e/o  
 scatolati in multistrato di legno di  
 pioppo. **Pannelli** da 18/25 mm  
 in particelle di legno di pioppo  
 in classe E1 a bassa emissione  
 di formaldeide e fibra di legno  
 naturale. **Espansi** di poliuretano  
 indeformabile a portanza  
 differenziata, densità da 18 kg/  
 mc a 40 kg/mc.  
**Primo rivestimento** in espanso  
 di poliestere accoppiato a caldo  
 a vellutino aggrappante in  
 poliestere e/o ovatta di poliestere  
 al 100% da 200gr. **Pannelli**  
**fondo** contenitore da 12-14 mm  
 in particelle di legno di pioppo in  
 classe E1.

**Technical characteristics**  
**Forgings** fir wood, and/or boxed  
 in poplar plywood. **Panels** 18/25  
 mm in poplar wood particles  
 class E1 low formaldehyde  
 emission and natural wood fiber.  
**Polyurethane foam**, crushproof,  
 of different capacity, density from  
 18 kg/mc to 40 kg/mc.  
**First coating** hot bonded  
 polyester foam, velvet adhesion  
 in polyester and/or 100%  
 polyester wool, 200gr. **Container**  
**bottom panels** 12-14 mm in  
 poplar wood particles class E1.

**Caractéristiques techniques**  
**Tige** en pin et/ou boitiers en  
 multicouche en bois de peuplier.  
**Panneaux** de 18/25 mm en  
 particules de bois de peuplier  
 classe E1 à faible émission  
 de formaldéhyde et fibre de  
 bois naturelle. **Polyuréthane**  
**expansé** indéformable à portée  
 différenciée, densité de 18kg/m<sup>2</sup>  
 à 40kg/m<sup>2</sup>.  
**Premier revêtement** en  
 polyester expansé accouplé à  
 chaud à un velours accrochant  
 en polyester et/ou ouate de  
 polyester à 100% de 200g.  
**Panneaux de fond coffre**  
**rangement** de 12-14mm en  
 particules de bois de peuplier  
 classe E1.

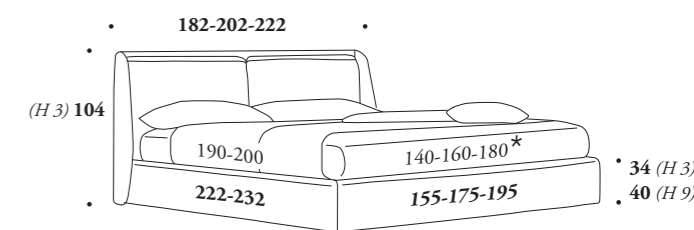

## Ring Eko



**Standard**  
 Basic  
 H 3 cm



**Varianti colore / Color variants / Couleurs disponibles**



**Optional**

**Lux**  
 H 3 cm



**The upholstered headboard**  
 gives a cozy and protective effect  
 and contains the large edge  
 pillows and the bed.  
 Optional possibility: integrated  
 LED lighting.

**La tête de lit rembourrée**  
 vous donne l'impression d'être  
 enveloppés et protégés et contient  
 les grands coussins du bord et le  
 lit. En option éclairage à LED  
 incorporé.

## Ring Tokyo



**Standard**  
 Ghost  
 H 13 cm

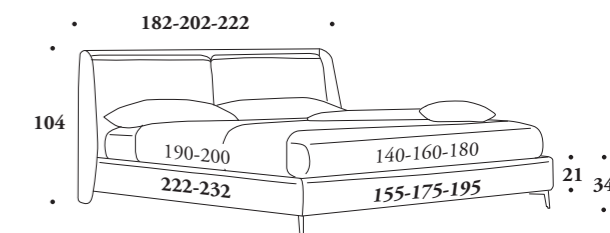

Senza possibilità di contenitore  
 solo con rete fissa  
 Without the possibility of  
 container only with fixed support  
 Sans possibilité de coffre de  
 rangement uniquement pour  
 sommier fixe

**Optional**

H 13 cm



Portagioie p. 376  
 Jewelry Box - Porte-bijoux



Lampada Led p. 374  
 Led Lamp - Lampes Led



Meccanica / Mechanism / Mécanique p. 382

Rete / Support / Sommier p. 380



30

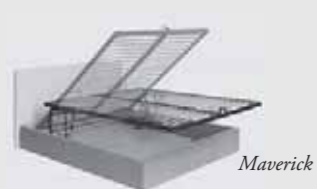

Maverick



Armony

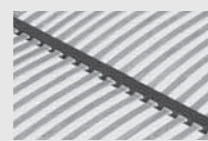

Thai  
 46 doghe / slats / lattes

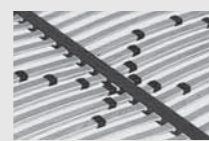

Energy  
 Non applicabile a rete da 120 cm  
 Not applicable to 120 cm support  
 Non applicable au sommier de 120 cm

Tessuto coprirete  
 traspirante antipolvere  
 Support cover fabric  
 breathable and dustproof  
 Tissu couvre-sommier  
 respirant anti-poussière

p. 384



Sacco contenitore  
 multiuso  
 Multipurpose  
 storage bag  
 Sac coffre de  
 rangement multi  
 usage

p. 385



p. 386

Regolatore  
 altezza rete  
 Support height  
 adjuster  
 Réglage  
 hauteur  
 sommier

p. 387

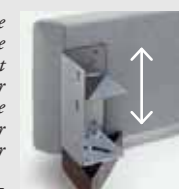

31

# Julius





Julius



*La linea del cordoncino a rilievo disegna, avvolge e lega la testiera. Un particolare sartoriale minimal ma prezioso.*

*The line of the cord in relief designs, surrounds, and binds the headboard. A minimal but precious sartorial detail.*

*La ligne du cordon en relief dessine en enveloppe la tête de lit. Un détail de couture minimaliste mais précieux.*

**Doppia possibilità per il ring.**

La versione più bassa è sollevata da una ricca scelta di piedini, per accentuare il senso di leggerezza.



**Double possibility for the ring.**

The lower and lighter version is raised by a rich choice of feet, to accentuate the sense of lightness.

**Double possibilité pour le tour de lit.**

La version plus basse et légère peut être est soulevée par un grand choix de pieds, pour accentuer le sens de légèreté.

**Julius**

Completamente sfoderabile  
Totally removable cover  
Complètement déhoussable

\*  
Rete L. 180 cm  
solo profondità 200 cm  
Support W. 180 cm  
only D 200 cm  
Sommier L. 180 cm  
uniquement en  
profondeur 200 cm

**Caratteristiche tecniche**  
**Masselli** in legno di abete e/o sciolati in multistrato di legno di pioppo. **Pannelli** da 18/25 mm in particelle di legno di pioppo in classe E1 a bassa emissione di formaldeide e fibra di legno naturale. **Espansi** di poliuretano indeformabile a portanza differenziata, densità da 18 kg/mc a 40 kg/mc.  
**Primo rivestimento** in espanso di poliestere accoppiato a caldo a vellutino aggrappante in poliestere e/o ovatta di poliestere al 100% da 200gr. **Pannelli fondo** contenitore da 12-14 mm in particelle di legno di pioppo in classe E1.

**Technical characteristics**  
**Forgings** fir wood, and/or boxed in poplar plywood. **Panels** 18/25 mm in poplar wood particles class E1 low formaldehyde emission and natural wood fiber. **Polyurethane foam**, crushproof, of different capacity, density from 18 kg/mc to 40 kg/mc.  
**First coating** hot bonded polyester foam, velvet adhesion in polyester and/or 100% polyester wool, 200gr. **Container bottom panels** 12-14 mm in poplar wood particles class E1.

**Caractéristiques techniques**  
**Tige** en pin et/ou boitiers en multicouche en bois de peuplier. **Panneaux** de 18/25 mm en particules de bois de peuplier classe E1 à faible émission de formaldéhyde et fibre de bois naturelle. **Polyuréthane expansé** indéformable à portée différenciée. densité de 18kg/m² à 40kg/m².  
**Premier revêtement** en polyester expansé accouplé à chaud à un velours accrochant en polyester et/ou ouate de polyester à 100% de 200g. **Panneaux de fond coffre** rangement de 12-14mm en particules de bois de peuplier classe E1.

**Ring Smart**



**Standard**  
**Basic**  
H 3 cm



**Varianti colore / Color variants / Couleurs disponibles**



**Lux**  
H 3 cm



**Optional**

**Visual**  
H 9 cm

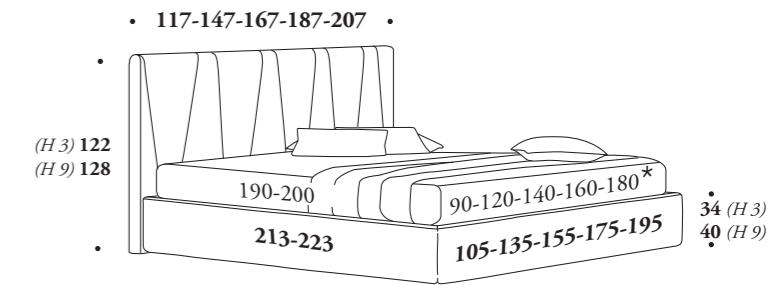

**Ring York**



**Standard**  
**Ghost**  
H 13 cm

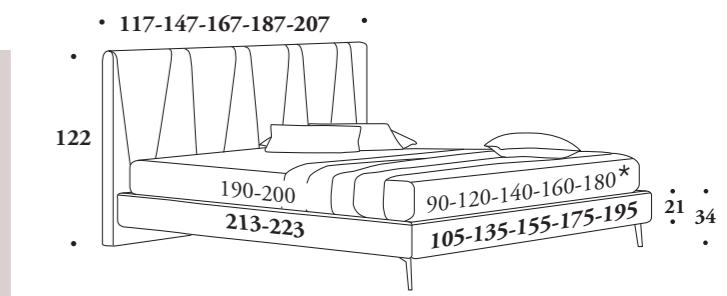

Senza possibilità di contenitore solo con rete fissa  
Without the possibility of container only with fixed support  
Sans possibilité de coffre de rangement uniquement pour sommier fixe

**Optional**  
H 13 cm



**Optional**  
**Accessori**  
**Accessoires**



Meccanica / Mechanism / Mécanique p. 382

Rete / Support / Sommier p. 380

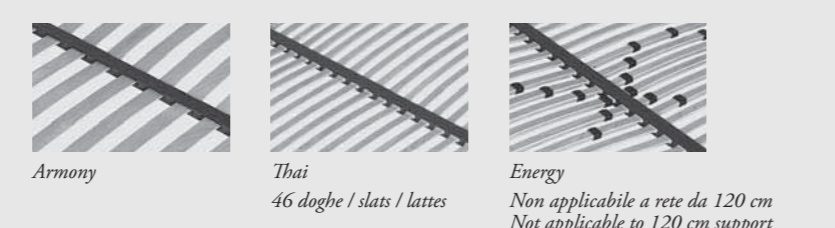
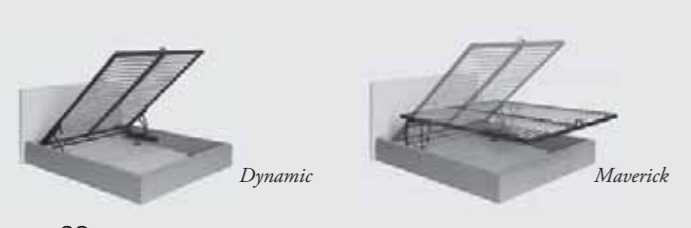

Tessuto coprirete traspirante antipolvere  
Support cover fabric breathable and dustproof  
Tissu couvre-sommier respirant anti-poussière  
p. 384

Sacco contenitore multiuso  
Multipurpose storage bag  
Sac coffre de rangement multi usage  
p. 385

Clean Up System  
Regolatore altezza rete  
Support height adjuster  
Réglage hauteur sommier  
p. 387

# Sommy





Sommy



**Sommier a rete e in versione con ring largo:** bordo di spessore piu ricco e importante. Profili in evidenza con cucitura pizzicata a rilievo. Sempre da abbinare a piacere ai morbidi elementi della boiserie.

La boiserie può essere attrezzata con pratici vassoi piani, rettangolari o arrotondati.

**Box spring and version with large ring:** thicker and bigger edge. Highlighted profiles with pinched stitching in relief. To be matched to taste with soft elements of the wall panel.

The wall panel can be equipped with practical flat trays, rectangular or rounded.

**Sommier à lattes ou avec avec cadre de lit large:** bord plus épais et plus important. Profils mis en évidence avec des coutures pincées en relief. À assortir aux éléments moelleux de la boiserie

La boiserie peut être dotée de plateaux rectangulaires ou arrondis.

## Sommy

Completamente sfoderabile  
Totally removable cover  
Complètement déhoussable

\*  
Rete L. 180 cm  
solo profondità 200 cm  
Support W. 180 cm only  
D 200 cm  
Sommier L. 180 cm  
uniquement en  
profondeur 200 cm

### Caratteristiche tecniche

**Masselli** in legno di abete e/o scatolati in multistrato di legno di pino. **Pannelli** da 18/25 mm in particelle di legno di pino in classe E1 a bassa emissione di formaldeide e fibra di legno naturale. **Espansi** di poliuretano indeformabile a portanza differenziata, densità da 18 kg/mc a 40 kg/mc.

**Primo rivestimento** in espanso di poliestere accoppiato a caldo a vellutino aggrappante in poliestere e/o ovatta di poliestere al 100% da 200gr. **Pannelli fondo** contenitore da 12-14 mm in particelle di legno di pino in classe E1.

### Technical characteristics

**Forings** fir wood, and/or boxed in poplar plywood. **Panels** 18/25 mm in poplar wood particles class E1 low formaldehyde emission and natural wood fiber. **Polyurethane foam**, crushproof, of different capacity, density from 18 kg/mc to 40 kg/mc.

**First coating** hot bonded polyester foam, velvet adhesion in polyester and/or 100% polyester wool, 200gr. **Container bottom panels** 12-14 mm in poplar wood particles class E1.

### Caractéristiques techniques

**Tige** en pin et/ou boitiers en multicouche en bois de peuplier. **Panneaux** de 18/25 mm en particules de bois de peuplier classe E1 à faible émission de formaldéhyde et fibre de bois naturelle. **Polyuréthane expansé** indéformable à portée différenciée. densité de 18kg/m<sup>2</sup> à 40kg/m<sup>2</sup>.

**Premier revêtement** en polyester expansé accouplé à chaud à un velours accrochant en polyester et/ou ovate de polyester à 100% de 200g. **Panneaux de fond coffre rangement** de 12-14mm en particules de bois de peuplier classe E1.

450

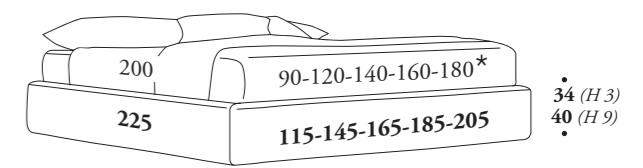
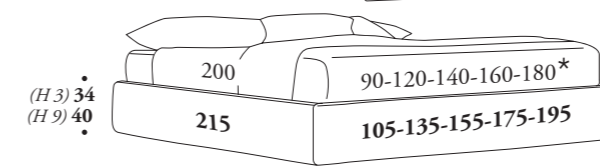
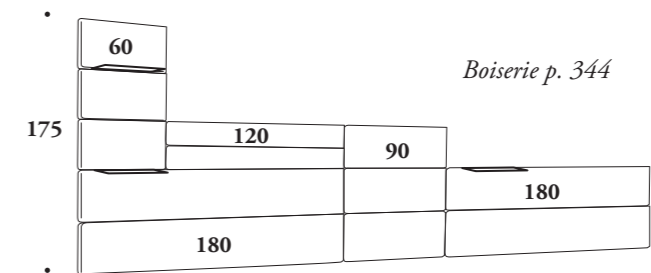

### Ring Sommy small



### Ring Sommy big



### Standard

#### Basic

H 3 cm



### Varianti colore / Color variants / Couleurs disponibles



### Lux

H 3 cm



### Visual

H 9 cm



Meccanica / Mechanism / Mécanique p. 382



44



Maverick

Rete / Support / Sommier p. 380

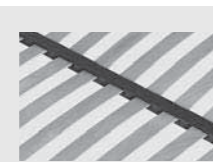

Armony

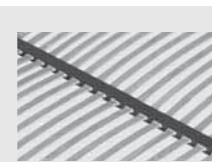

Thai  
46 doghe / slats / lattes

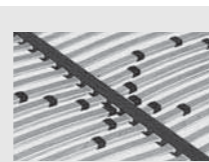

Energy  
Non applicabile a rete da 120 cm  
Not applicable to 120 cm support  
Non applicable au sommier de 120 cm

Tessuto coprirete  
traspirante antipolvere  
Support cover fabric  
breathable and dustproof  
Tissu couvre-sommier  
transpirant anti-poussière

p. 384



Sacco contenitore  
multiuso  
Multipurpose  
storage bag  
Sac coffre de  
rangement multi  
usage

p. 385



p. 386

Regolatore  
altezza rete  
Support height  
adjuster  
Réglage  
hauteur  
sommier

p. 387



45



Tiffany

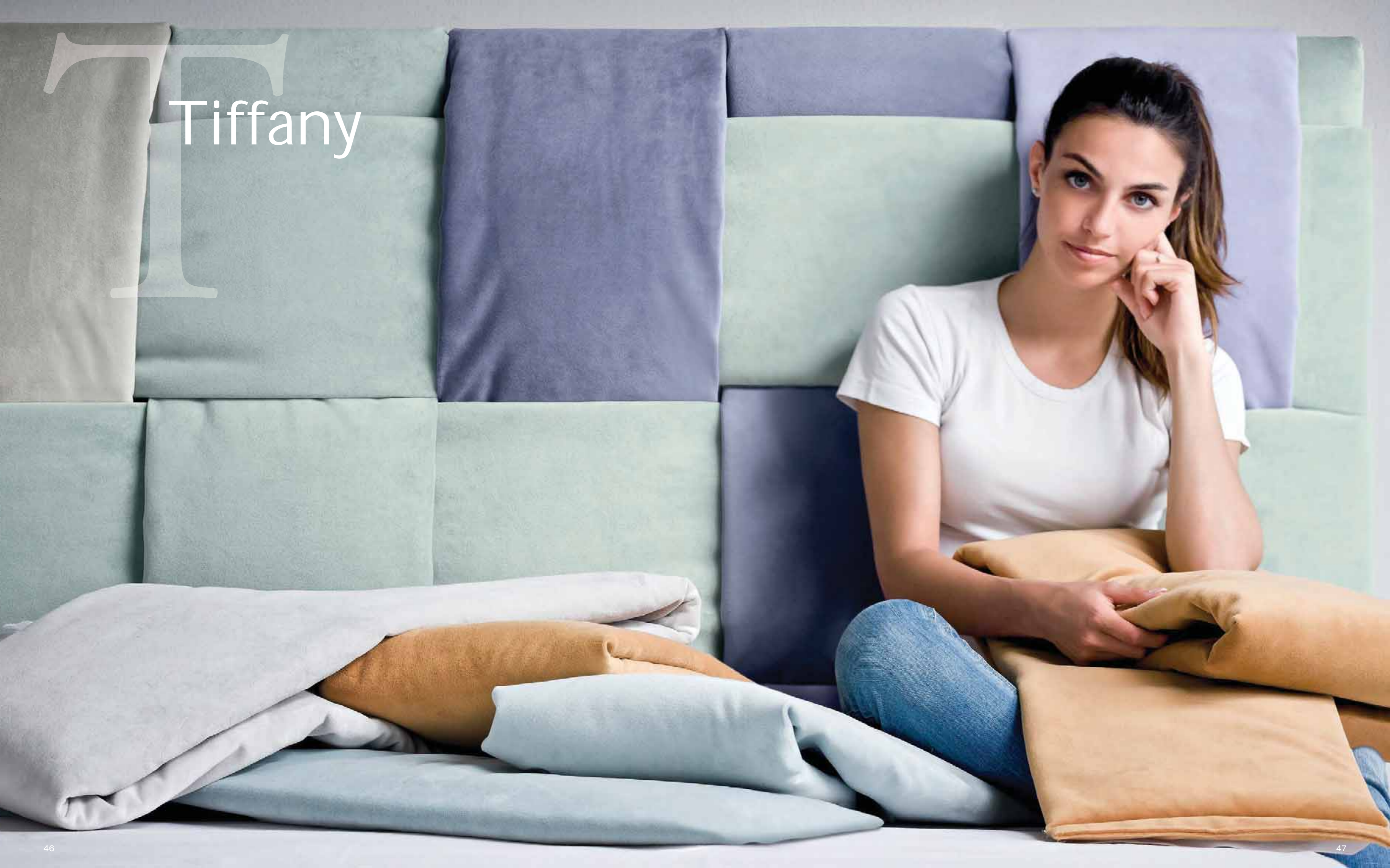



Tiffany



***9 fasce di morbido tessuto**  
si intrecciano sulla testiera in  
un colorato meshwork.  
Grande libertà di composizione.  
Anche in futuro se vorrai  
potrai sostituire dei tessuti per  
cambiare gli accostamenti e  
liberare la tua creatività.*

***9 bands of soft fabric**  
intertwine on the headboard in  
a colorful meshwork.  
Great freedom of composition.  
In the future, you will be able  
to replace the fabric to change  
the combinations and unleash  
your creativity.*

***9 bandes de tissus moelleux**  
s'entrecroisent sur la tête de lit  
en un meshwork coloré.  
Grande liberté de composition.  
Possibilité de remplacer les tissus  
pour changer l'assemblage et  
libérer la créativité.*







**Il giroletto trapuntato**  
*sempre soffice e morbido riprende il tema quadro coordinato all'intreccio delle grandi fasce di tessuto della testiera. Tutte le fasce o solo alcune possono poi essere sostituite nel tempo per avere la testiera sempre perfetta o per rinnovarla cambiando i colori...*

**The quilted bed frame**  
*always soft and fluffy, it reprises the theme of the framework coordinated with the interweaving of the large bands of fabric on the headboard. All the bands or some of them can then be replaced in time for an always perfect headboard or to renew it by changing colors...*

**Le tour de lit matelassé**  
*toujours doux et moelleux, reprend le thème carré assorti à l'entrecroisement des bandes de tissu de la tête de lit. Toutes les bandes ou certaines bandes peuvent être changées de manière à avoir toujours une tête de lit parfaite ou pour « changer » de tête de lit en changeant de couleurs...*

## Tiffany

Completamente sfoderabile  
 Totally removable cover  
 Complètement déhoussable

\*  
 Rete L. 180 cm  
 solo profondità 200 cm  
 Support W. 180 cm  
 only D 200 cm  
 Sommier L. 180 cm  
 uniquement en  
 profondeur 200 cm

**Caratteristiche tecniche**  
**Masselli** in legno di abete e/o sciolati in multistrato di legno di pioppo. **Pannelli** da 18/25 mm in particelle di legno di pioppo in classe E1 a bassa emissione di formaldeide e fibra di legno naturale. **Espansi** di poliuretano indeformabile a portanza differenziata, densità da 18 kg/mc a 40 kg/mc. **Primo rivestimento** in espanso di poliestere accoppiato a caldo a vellutino aggrappante in poliestere e/o ovatta di poliestere al 100% da 200gr. **Pannelli fondo** contenitore da 12-14 mm in particelle di legno di pioppo in classe E1.

**Technical characteristics**  
**Forgings** fir wood, and/or boxed in poplar plywood. **Panels** 18/25 mm in poplar wood particles class E1 low formaldehyde emission and natural wood fiber. **Polyurethane foam**, crushproof, of different capacity, density from 18 kg/mc to 40 kg/mc. **First coating** hot bonded polyester foam, velvet adhesion in polyester and/or 100% polyester wool, 200gr. **Container bottom panels** 12-14 mm in poplar wood particles class E1.

**Caractéristiques techniques**  
**Tige** en pin et/ou boîtiers en multicouche en bois de peuplier. **Panneaux** de 18/25 mm en particules de bois de peuplier classe E1 à faible émission de formaldéhyde et fibre de bois naturelle. **Polyuréthane expansé** indéformable à portée différenciée. densité de 18kg/m<sup>2</sup> à 40kg/m<sup>2</sup>. **Premier revêtement** en polyester expansé accouplé à chaud à un velours accrochant en polyester et/ou ouate de polyester à 100% de 200g. **Panneaux de fond coffre** rangement de 12-14mm en particules de bois de peuplier classe E1.

## Ring Pinup



**Standard**  
**Basic**  
 H 3 cm



**Varianti colore / Color variants / Couleurs disponibles**



**Optional**  
**Lux**  
 H 3 cm



Anche successivamente all'acquisto è possibile ordinare fasce nuove o diverse per sostituzione, rinnovo parziale o totale.

Even after the purchase it is possible to order new or different bands for replacement, or partial or total renewal.

Après l'achat il est possible de commander de nouvelles bandes pour un remplacement partiel ou total.

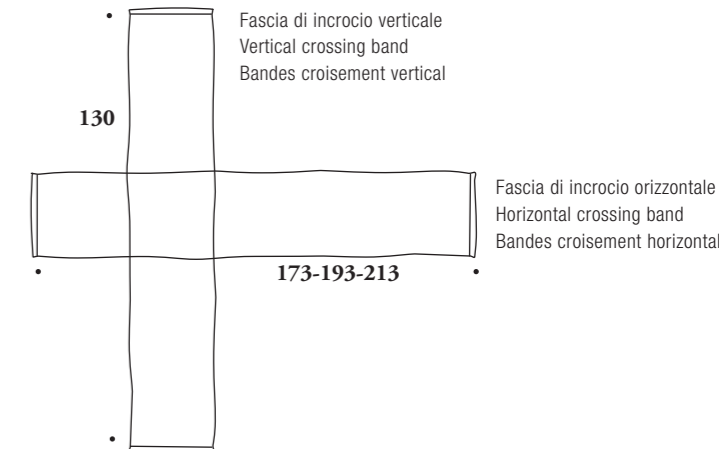

**Optional**  
**Accessori**  
**Accessoires**

**Panquette**  
**Panquette**  
 p. 370



**Pouf con**  
**contenitore**  
**Pouf with**  
**container**  
**Pouf avec**  
**rangement**  
 p. 368



**Sacca**  
**portaoggetti**  
**Storage bag**  
**Sac porte-objets**  
 p. 375



Meccanica / Mechanism / Mécanique p. 382

Rete / Support / Sommier p. 380



56

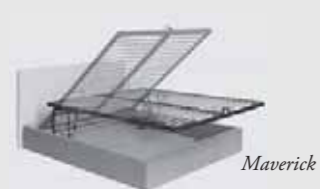

Maverick



Armony

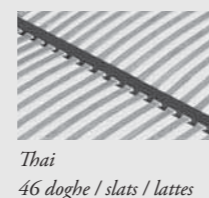

Thai  
 46 doghe / slats / lattes

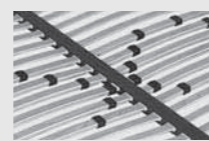

Energy  
 Non applicabile a rete da 120 cm  
 Not applicable to 120 cm support  
 Non applicable au sommier de 120 cm

Tessuto coprirete  
 traspirante antipolvere  
 Support cover fabric  
 breathable and dustproof  
 Tissu couvre-sommier  
 respirant anti-poussière  
 p. 384



Sacco contenitore  
 Multipurpose  
 storage bag  
 Sac coffre de  
 rangement multi  
 usage  
 p. 385



p. 386

Regolatore  
 altezza rete  
 Support height  
 adjuster  
 Réglage  
 hauteur  
 sommier  
 p. 387

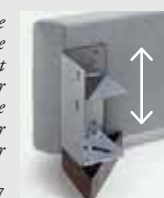

57

# E Edgar





Edgar

- Relax System -





### **Relax System**

*Grazie all'innovativa soluzione dei cuscini reclinabili molte testiere sono relax system, consentono cioè una comoda posizione "seduta" e un pratico appoggio di sostegno per leggere, guardare la tv, lavorare al laptop...*

**Il rivestimento avvolge i grandi cuscini** e li impreziosisce con un nuovo inconsueto disegno che, libero, naturale e senza bottoni, muove la superficie ed evidenzia il morbido spessore.

### **Relax System**

*With the innovative solution of the headboard cushions, many headboards become relaxation systems, that is, allow a comfortable position while "sitting" and a practical support for reading, watching TV, working on laptop... **The cover surrounds the large pillows** and marks them with a new unusual design that, free, natural, and without buttons, moves the surface and highlights the soft thickness.*

### **Relax System**

*Grâce à la solution innovante des coussins tête de lit inclinable, de nombreuses tête de lits sont « relax system », elles permettent d'avoir une position assise commode et un appui pratique pour lire, regarder la télé, travailler avec l'ordinateur portable... **Le revêtement enveloppe les grands coussins**, il les marque avec un nouveau dessin qui est libre, naturel et sans boutons, il ravive et il met en évidence l'épaisseur moelleuse.*





**Particolare sartoriale**  
della doppia cucitura a rilievo  
con ribattitura.

**Detail of the double stitching**  
in relief with top stitching.

**Détail couture: la double**  
couture en relief.



Portagioie p. 376  
Jewelry Box - Porte-bijoux



Porta USB p. 377  
USB holder - Port USB

## Edgar

Completamente sfoderabile  
Totally removable cover  
Complètement déhoussable

\*  
Rete L. 180 cm  
solo profondità 200 cm  
Support W. 180 cm  
only D 200 cm  
Sommier L. 180 cm  
uniquement en  
profondeur 200 cm

**Caratteristiche tecniche**  
**Masselli** in legno di abete e/o  
scatolati in multistrato di legno di  
pioppo. **Pannelli** da 18/25 mm  
in particelle di legno di pioppo  
in classe E1 a bassa emissione  
di formaldeide e fibra di legno  
naturale. **Espansi** di poliuretano  
in densità da 18 kg/mc a 40 kg/  
mc. **Cuscini** rivestiti in ovatta da  
300 gr. **Primo rivestimento** in  
espanso di poliestere accoppiato  
a caldo a vellutino aggrappante  
in poliestere e/o ovatta di  
poliestere al 100% da 200gr.  
**Pannelli fondo** contenitore da  
12-14 mm in particelle di legno  
di pioppo in classe E1.

**Technical characteristics**  
**Forgings** fir wood, and/or boxed  
in poplar plywood. **Panels** 18/25  
mm in poplar wood particles  
class E1 low formaldehyde  
emission and natural wood fiber.  
**Polyurethane foam** density  
from 18 kg/mc to 40 kg/mc.  
**Cushions** coated with 300 gr  
wadding. **First coating** hot  
bonded polyester foam, velvet  
adhesion in polyester and/or  
100% polyester wool, 200gr.  
**Container bottom panels** 12-  
14 mm in poplar wood particles  
class E1.

**Caractéristiques techniques**  
**Tige** en pin et/ou boitiers en  
multicouche en bois de peuplier.  
**Panneaux** de 18/25 mm en  
particules de bois de peuplier  
classe E1 à faible émission  
de formaldéhyde et fibre de  
bois naturelle. **Polyuréthane**  
**expansé** densité de 18kg/m<sup>2</sup> à  
40kg/m<sup>2</sup>. **Coussin** rembourrés  
avec de la ouate de 300g.  
**Premier revêtement** en  
polyester expansé accouplé à  
chaud à un velours accrochant  
en polyester et/ou ouate de  
polyester à 100% de 200g.  
**Panneaux de fond coffre**  
**rangement** de 12-14mm en  
particules de bois de peuplier  
classe E1.

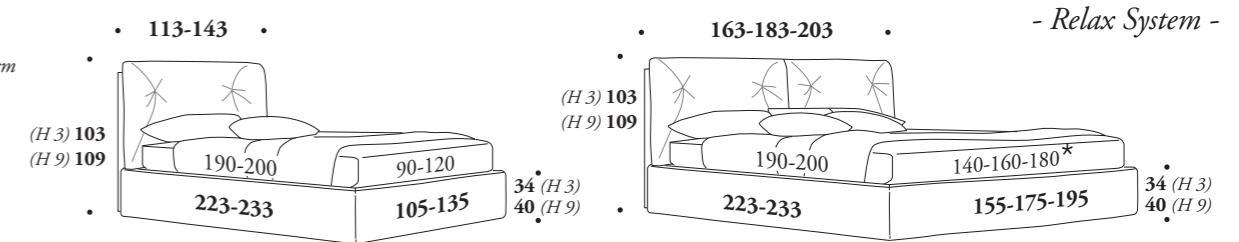

- Relax System -

## Ring Eko



Standard  
Basic  
H 3 cm



Varianti colore / Color variants / Couleurs disponibles



Optional

Lux  
H 3 cm



Visual  
H 9 cm



Optional  
Accessori  
Accessoires

Panquette  
Panquette



p. 370

Pouf con  
contenitore  
Pouf with  
container  
Pouf avec  
rangement



p. 368

Sacca  
portaoggetti  
Storage bag  
Sac porte-objets



p. 375

Meccanica / Mechanism / Mécanique p. 382



Dynamic

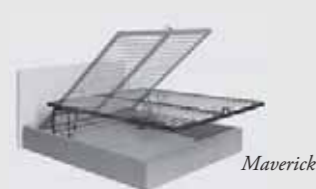

Maverick

64

Rete / Support / Sommier p. 380

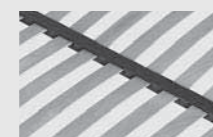

Armony

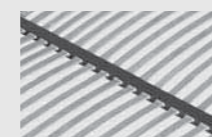

Thai  
46 doghe / slats / lattes

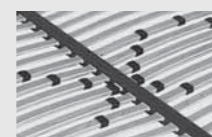

Energy

Non applicabile a rete da 120 cm  
Not applicable to 120 cm support  
Non applicable au sommier de 120 cm

p. 384

Tessuto coprirete  
traspirante antipolvere  
Support cover fabric  
breathable and dustproof  
Tissu couvre-sommier  
transpirant anti-poussière



Sacco contenitore  
Multipurpose  
storage bag  
Sac coffre de  
rangement multi  
usage



p. 385



p. 386

Regolatore  
altezza rete  
Support height  
adjuster  
Réglage  
hauteur  
sommier



p. 387

65

# D Penny

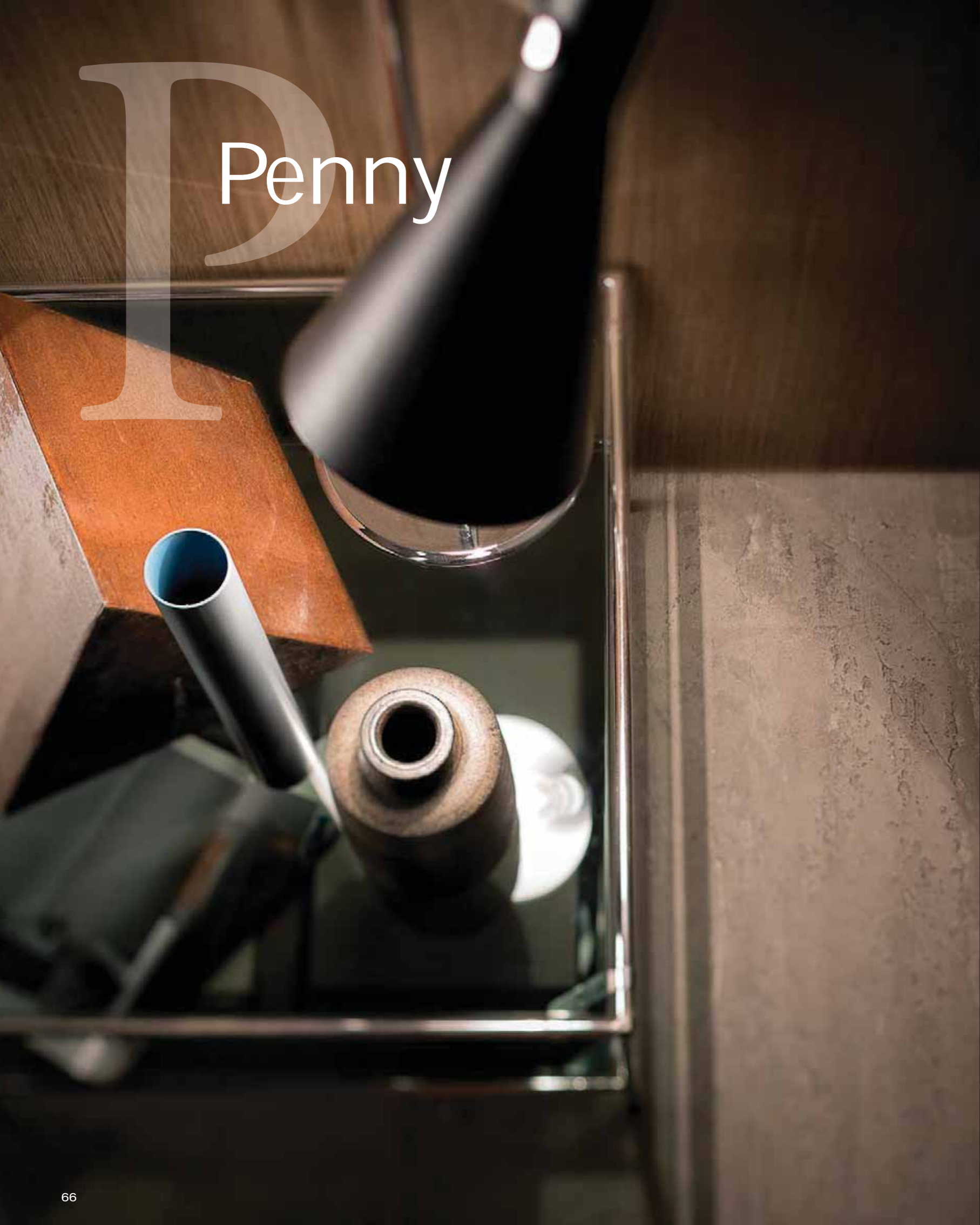



Penny





*Molte soluzioni diverse di piedini per tante possibilità di abbinamento anche per il ring basso.*



*Many different solutions for the feet for many combination possibilities also for the low ring.*

*De nombreuses solutions de pieds pour les nombreuses possibilités de combinaison du tour de lit bas.*

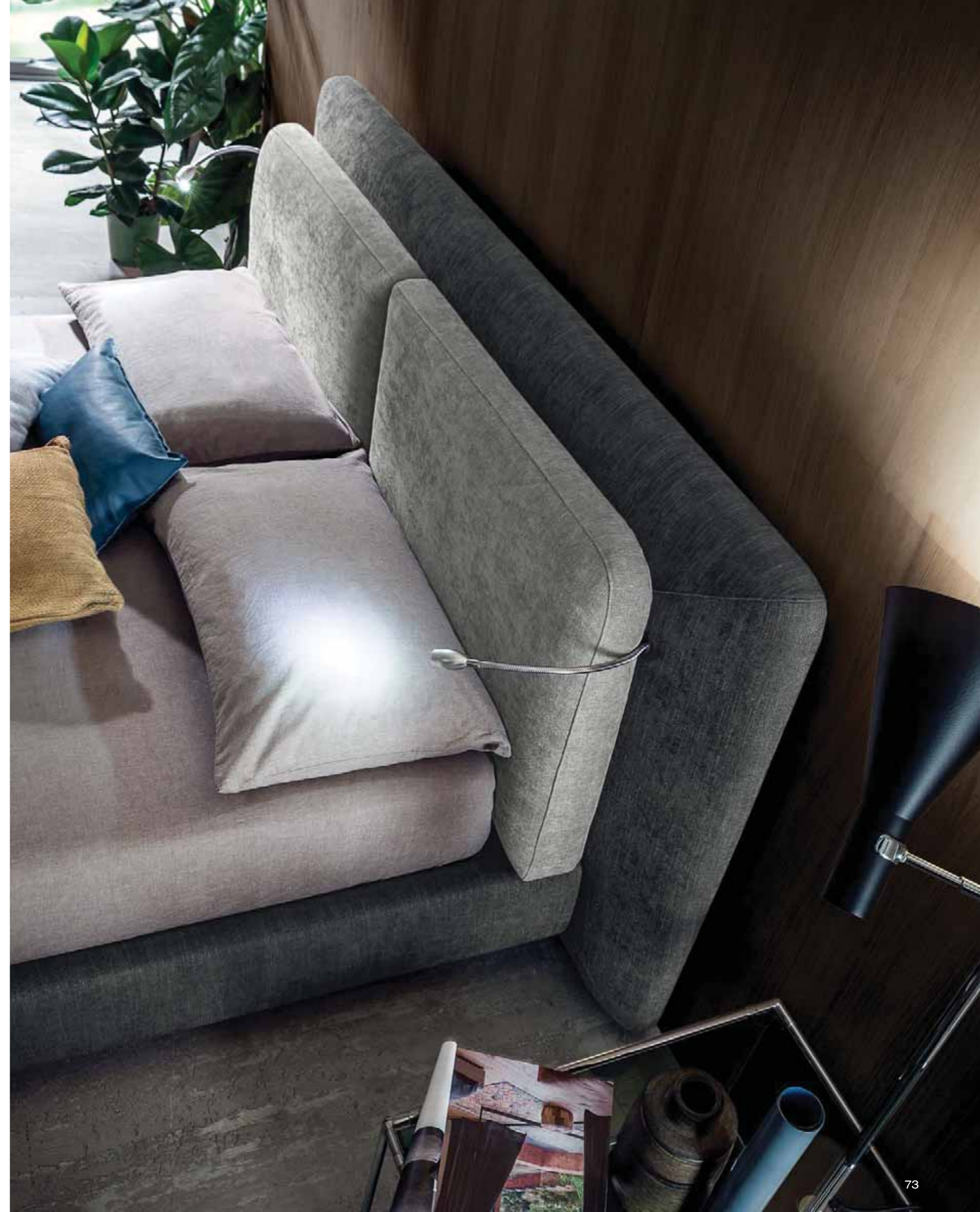

*Il comodo accessorio della luce a LED orientabile inseribile nella testiera. Molto pratico nel facile azionamento "touch". Un semplice tocco sulla lampada per accendere o spegnere.*

*The convenient LED light accessory adjustable already in the headboard.  
Very practical in the easy "touch" version. A simple touch on the lamp to turn it on or off.*

*L'accessoire pratique de la lampe à LED orientable inclue dans la tête de lit.  
Très pratique à commande tactile. Un simple toucher sur la lampe pour l'allumer ou l'éteindre.*

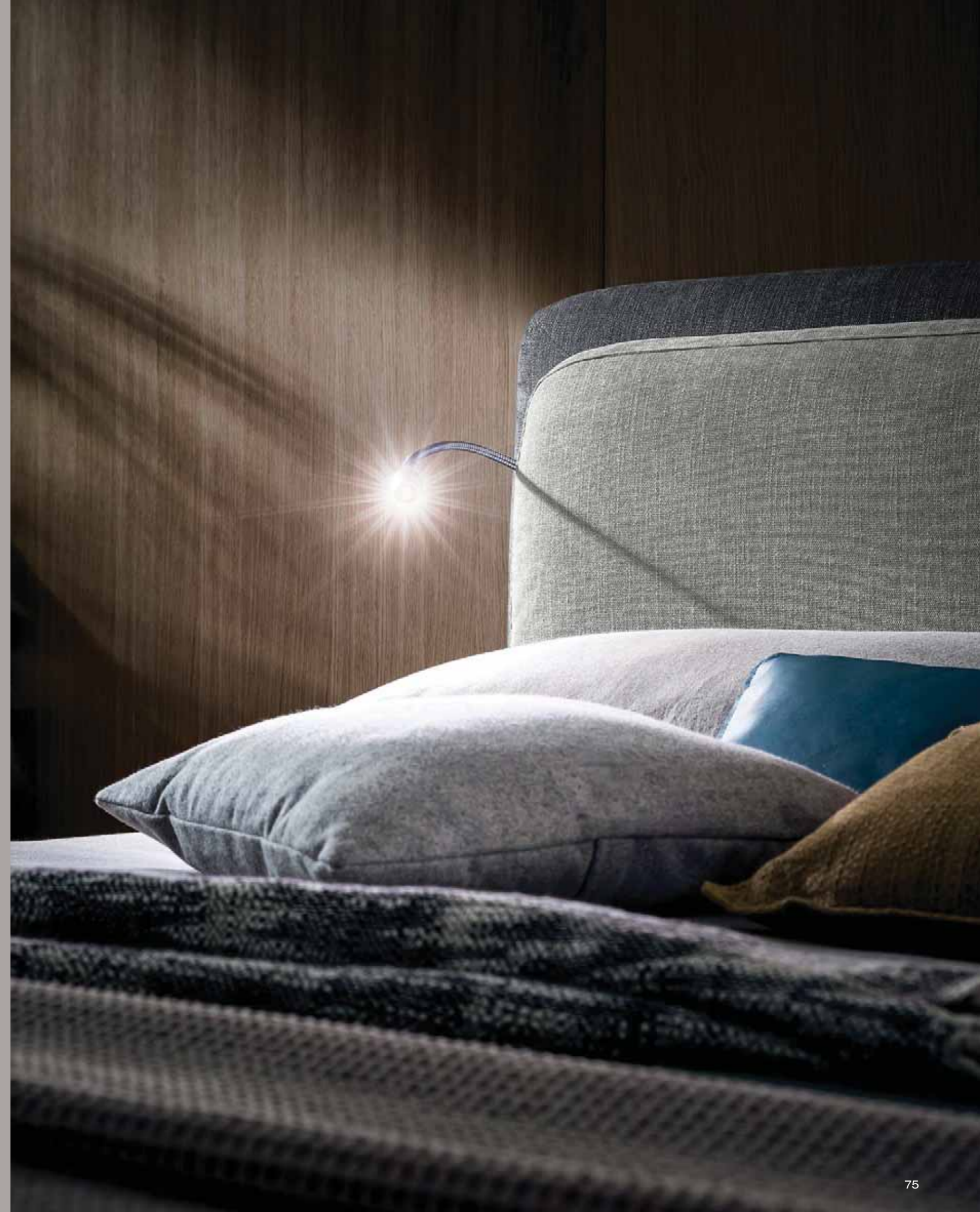



*La doppia imbottitura della grande testiera e dei cuscini indipendenti. Una scelta di design ma anche una scelta di comfort.*



*The double padding of the large headboard and independent pillows. A choice in design but also a choice of comfort.*

*Le double rembourrage de la grande tête de lit et des coussins indépendants. Un choix de design mais aussi un choix de confort.*



Portagioie p. 376  
Jewelry Box - Porte-bijoux



Lampada Led p. 374  
Led Lamp - Lampes Led

Meccanica / Mechanism / Mécanique p. 382

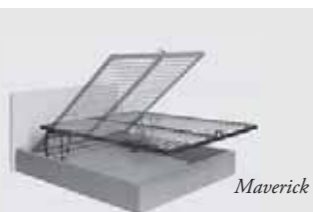

Maverick



Armony

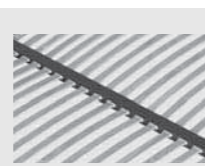

Thai  
46 doghe / slats / lattes

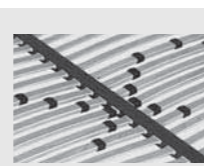

Energy  
Non applicabile a rete da 120 cm  
Not applicable to 120 cm support  
Non applicable au sommier de 120 cm

Rete / Support / Sommier p. 380

## Penny

Completamente sfoderabile  
Totally removable cover  
Complètement déhoussable

\*  
Rete L. 180 cm  
solo profondità 200 cm  
Support W. 180 cm  
only D 200 cm  
Sommier L. 180 cm  
uniquement en  
profondeur 200 cm

**Caratteristiche tecniche**  
**Masselli** in legno di abete e/o scatolati in multistrato di legno di pioppo. **Pannelli** da 18/25 mm in particelle di legno di pioppo in classe E1 a bassa emissione di formaldeide e fibra di legno naturale. **Espansi** di poliuretano indeformabile a portanza differenziata, densità da 18 kg/mc a 40 kg/mc.  
**Primo rivestimento** in espanso di poliestere accoppiato a caldo a vellutino aggrappante in poliestere e/o ovatta di poliestere al 100% da 200gr. **Pannelli fondo** contenitore da 12-14 mm in particelle di legno di pioppo in classe E1.

**Technical characteristics**  
**Forgings** fir wood, and/or boxed in poplar plywood. **Panels** 18/25 mm in poplar wood particles class E1 low formaldehyde emission and natural wood fiber. **Polyurethane foam**, crushproof, of different capacity, density from 18 kg/mc to 40 kg/mc.  
**First coating** hot bonded polyester foam, velvet adhesion in polyester and/or 100% polyester wool, 200gr. **Container bottom panels** 12-14 mm in poplar wood particles class E1.

**Caractéristiques techniques**  
**Tige** en pin et/ou boitiers en multicouche en bois de peuplier. **Panneaux** de 18/25 mm en particules de bois de peuplier classe E1 à faible émission de formaldéhyde et fibre de bois naturelle. **Polyuréthane expansé** indéformable à portée différenciée. densité de 18kg/m<sup>2</sup> à 40kg/m<sup>2</sup>.  
**Premier revêtement** en polyester expansé accouplé à chaud à un velours accrochant en polyester et/ou ouate de polyester à 100% de 200g. **Panneaux de fond coffre rangement** de 12-14mm en particules de bois de peuplier classe E1.

Tessuto coprirete  
traspirante antipolvere  
Support cover fabric  
breathable and dustproof  
Tissu couvre-sommier  
transpirant anti-poussière

## Ring Eko



Standard  
Basic  
H 3 cm

wengé  
wengé  
wengé

Varianti colore / Color variants / Couleurs disponibles

nero  
black  
noir

bianco  
white  
blanc

argento  
silver  
argent

Optional

Lux  
H 3 cm

wengé  
wengé  
wengé

nero  
black  
noir

bianco  
white  
blanc

cromo  
chrome  
chrome

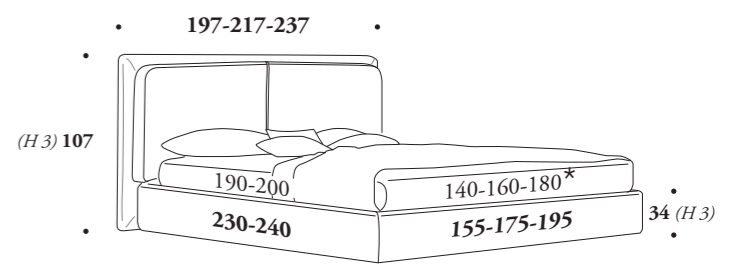

## Ring Tokyo



Standard  
Ghost  
H 13 cm

wengé  
wengé  
wengé

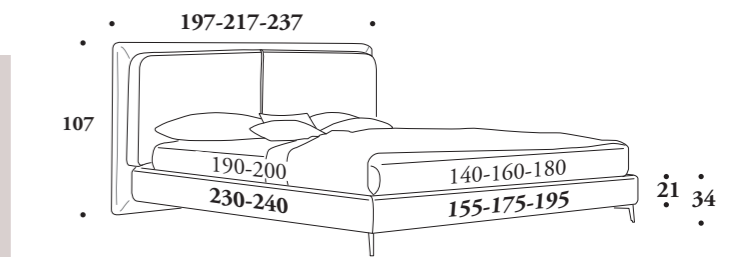

Senza possibilità di contenitore  
solo con rete fissa  
Without the possibility of  
container only with fixed support  
Sans possibilité de coffre de  
rangement uniquement pour  
sommier fixe

Optional

H 13 cm

Blade  
satinato  
satin  
satiné

Blade  
bronzato  
bronze  
bronze

Tower

Plexy

Optional  
Accessori  
Accessories  
Accessoires

Panquette  
Panquette  
Panquette



Pouf con  
contenitore  
Pouf with  
container  
Pouf avec  
rangement



Sacca  
portaoggetti  
Storage bag  
Sac porte-objets



Dynamic

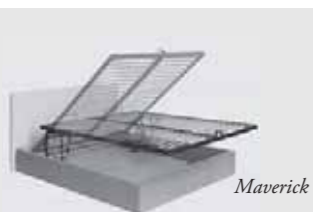

Maverick



Armony

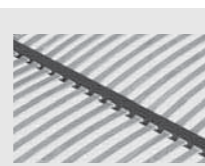

Thai  
46 doghe / slats / lattes

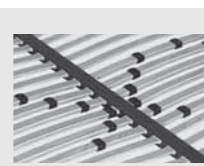

Energy  
Non applicabile a rete da 120 cm  
Not applicable to 120 cm support  
Non applicable au sommier de 120 cm

Tessuto coprirete  
traspirante antipolvere  
Support cover fabric  
breathable and dustproof  
Tissu couvre-sommier  
transpirant anti-poussière

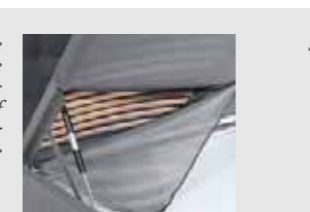

Sacco contenitore  
multipurpose  
storage bag  
Sac coffre de  
rangement multi  
usage

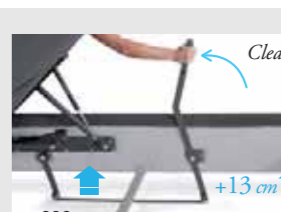

Clean Up System

Regolatore  
altezza rete  
Support height  
adjuster  
Réglage  
hauteur  
sommier





# H Hamilton





# Hamilton

*La testiera grande e morbida  
è caratterizzata dall'effetto capittonè  
che evidenzia lo spessore dell'imbottitura.  
Il giroletto è segnato dalla modularità  
delle doppie cuciture verticali.*

*The big and soft headboard is  
characterized by the quilted effect that  
highlights the thickness of the padding.  
The bed frame is marked by the  
modularity of double vertical seams.*

*La tête de lit grande et moelleuse est  
caractérisée par l'effet capiton qui met  
en évidence l'épaisseur du rembourrage.  
Le tour de lit est caractérisé par la  
modularité des doubles coutures verticales.*







*La lavorazione della testiera è morbida e profonda, ed evidenzia la particolare cucitura.*

*Il gioco dei vuoti e dei pieni ne enfatizza lo spessore.*

*The processing of the headboard is soft and deep, highlighting the particular work. The game of empty and filled spaces emphasizes its thickness.*

*La réalisation de la tête de lit moelleuse et profonde, met en évidence la réalisation particulière. Le jeu des vides et des pleins amplifie l'épaisseur.*

## Hamilton

Completamente sfoderabile  
Totally removable cover  
Complètement déhoussable

\*  
Rete L. 180 cm  
solo profondità 200 cm  
Support W. 180 cm  
only D 200 cm  
Sommier L. 180 cm  
uniquement en  
profondeur 200 cm

### Caratteristiche tecniche

**Masselli** in legno di abete e/o scatolati in multistrato di legno di pioppo. **Pannelli** da 18/25 mm in particelle di legno di pioppo in classe E1 a bassa emissione di formaldeide e fibra di legno naturale. **Espansi** di poliuretano indeformabile a portanza differenziata, densità da 18 kg/mc a 40 kg/mc.

**Primo rivestimento** in espanso di poliestere accoppiato a caldo a vellutino aggrappante in poliestere e/o ovatta di poliestere al 100% da 200gr. **Pannelli fondo** contenitore da 12-14 mm in particelle di legno di pioppo in classe E1.

### Technical characteristics

**Forgings** fir wood, and/or boxed in poplar plywood. **Panels** 18/25 mm in poplar wood particles class E1 low formaldehyde emission and natural wood fiber. **Polyurethane foam**, crushproof, of different capacity, density from 18 kg/mc to 40 kg/mc.

**First coating** hot bonded polyester foam, velvet adhesion in polyester and/or 100% polyester wool, 200gr. **Container bottom panels** 12-14 mm in poplar wood particles class E1.

### Caractéristiques techniques

**Tige** en pin et/ou boitiers en multicouche en bois de peuplier. **Panneaux** de 18/25 mm en particules de bois de peuplier classe E1 à faible émission de formaldéhyde et fibre de bois naturelle. **Polyuréthane expansé** indéformable à portée différenciée, densité de 18kg/m<sup>2</sup> à 40kg/m<sup>2</sup>.

**Premier revêtement** en polyester expansé accouplé à chaud à un velours accrochant en polyester et/ou ouate de polyester à 100% de 200g. **Panneaux de fond coffre rangement** de 12-14mm en particules de bois de peuplier classe E1.

## Ring Neo



### Standard

Basic  
H 3 cm

wengé  
wengé  
wengé



### Varianti colore / Color variants / Couleurs disponibles

nero  
black  
noir



bianco  
white  
blanc



argento  
silver  
argent



### Optional

Lux  
H 3 cm

wengé  
wengé  
wengé



nero  
black  
noir



bianco  
white  
blanc



romo  
chrome  
chrome



### Optional

Accessori  
Accessoires

Panquette  
Panquette  
Panquette



p. 370

Pouf con  
contenitore  
Pouf with  
container  
Pouf avec  
rangement



p. 368

Sacca  
portaoggetti  
Storage bag  
Sac porte-objets



p. 375

Meccanica / Mechanism / Mécanique p. 382

Rete / Support / Sommier p. 380



Dynamic

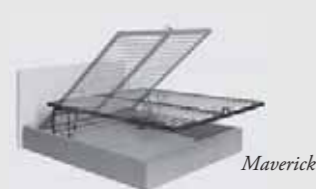

Maverick

86

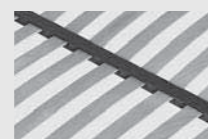

Armony

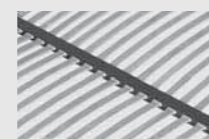

Thai

46 doghe / slats / lattes

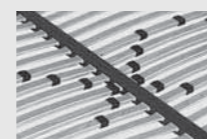

Energy

Non applicabile a rete da 120 cm  
Not applicable to 120 cm support  
Non applicable au sommier de 120 cm

Tessuto coprirete  
traspirante antipolvere  
Support cover fabric  
breathable and dustproof  
Tissu couvre-sommier  
transpirant anti-poussière

p. 384

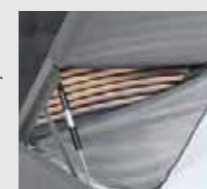

Sacco contenitore  
Multipurpose  
storage bag  
Sac coffre de  
rangement multi  
usage

p. 385

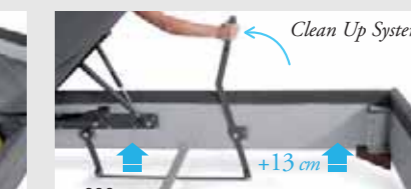

p. 386

Clean Up System

Regolatore  
altezza rete  
Support height  
adjuster  
Réglage  
hauteur  
sommier

p. 387



87

Allen





Allen  
- Relax System -



*I grandi morbidi cuscini sono arricchiti dalla trapuntatura a rombi, una citazione classica per un letto moderno.*

*Sono mobili, indipendenti (1) e possono essere appoggiati al materasso in posizione relax (2) "seduta": da lettura... da tv... da tablet...*



*The big fluffy pillows are enriched by the lozenge quilting, a classic reference for a modern bed. They are mobile, independent (1) and can be placed against the mattress in the "sitting" position (2) for your relax: for reading... watching tv... using your tablet...*

*Les grands coussins moelleux sont enrichis d'un capitonnage à losanges, un rappel classique pour un lit moderne. Ils sont indépendants (1) et peuvent être placés sur le matelas en position relax (2) "assise": de lecture... de télé... de tablette...*







# Allen

Completamente sfoderabile  
Totally removable cover  
Complètement déhoussable

\*  
Rete L. 180 cm  
solo profondità 200 cm  
Support W. 180 cm  
only D 200 cm  
Sommier L. 180 cm  
uniquement en  
profondeur 200 cm

### Caratteristiche tecniche

**Masselli** in legno di abete e/o sciolati in multistrato di legno di pioppo. **Pannelli** da 18/25 mm in particelle di legno di pioppo in classe E1 a bassa emissione di formaldeide e fibra di legno naturale. **Espansi** di poliuretano indeformabile a portanza differenziata, densità da 18 kg/mc a 40 kg/mc.

**Primo rivestimento** in espanso di poliestere accoppiato a caldo a vellutino aggrappante in poliestere e/o ovatta di poliestere al 100% da 200gr. **Pannelli fondo** contenitore da 12-14 mm in particelle di legno di pioppo in classe E1.

### Technical characteristics

**Forgings** fir wood, and/or boxed in poplar plywood. **Panels** 18/25 mm in poplar wood particles class E1 low formaldehyde emission and natural wood fiber.

**Polyurethane foam**, crushproof, of different capacity, density from 18 kg/mc to 40 kg/mc.

**First coating** hot bonded polyester foam, velvet adhesion in polyester and/or 100% polyester wool, 200gr. **Container bottom panels** 12-14 mm in poplar wood particles class E1.

### Caractéristiques techniques

**Tige** en pin et/ou boitiers en multicouche en bois de peuplier.

**Panneaux** de 18/25 mm en particules de bois de peuplier classe E1 à faible émission de formaldéhyde et fibre de bois naturelle. **Polyuréthane expansé** indéformable à portée différenciée, densité de 18kg/m<sup>2</sup> à 40kg/m<sup>2</sup>.

**Premier revêtement** en polyester expansé accouplé à chaud à un velours accrochant en polyester et/ou ouate de polyester à 100% de 200g.

**Panneaux de fond coffre rangement** de 12-14mm en particules de bois de peuplier classe E1.

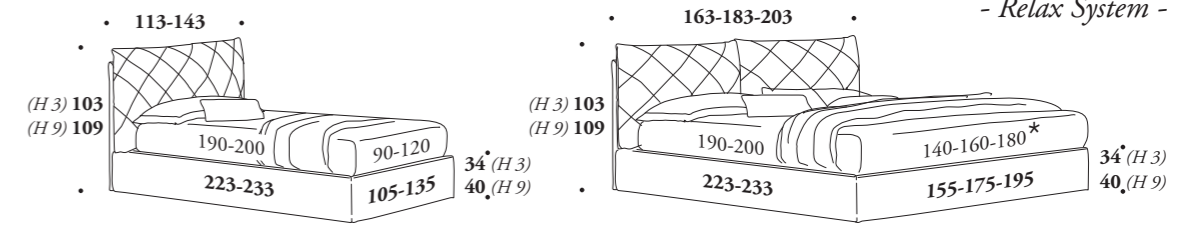

- Relax System -

## Ring Eko



## Ring Liberty



### Standard

Basic

H 3 cm



### Varianti colore / Color variants / Couleurs disponibles



### Lux

H 3 cm



Optional

Visual

H 9 cm



Portagioie p. 376  
Jewelry Box - Porte-bijoux



Porta USB p. 377  
USB holder - Port USB

### Optional

Accessori  
Accessories  
Accessoires

Panquette  
Panquette  
Panquette



p. 370

Pouf con  
contenitore  
Pouf with  
container  
Pouf avec  
rangement



p. 368

Sacca  
portaoggetti  
Storage bag  
Sac porte-objets



p. 375

### Meccanica / Mechanism / Mécanique p. 382



94

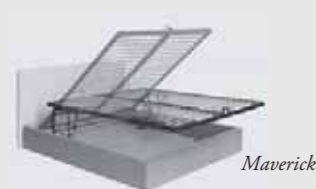

Maverick

### Rete / Support / Sommier p. 380

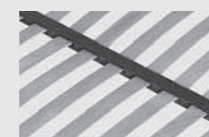

Armony

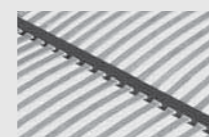

Thai  
46 doghe / slats / lattes

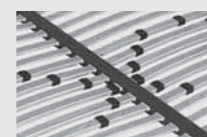

Energy  
Non applicabile a rete da 120 cm  
Not applicable to 120 cm support  
Non applicable au sommier de 120 cm

Tessuto coprirete  
traspirante antipolvere  
Support cover fabric  
breathable and dustproof  
Tissu couvre-sommier  
transpirant anti-poussière

p. 384



Sacco contenitore  
Multiuso  
Multipurpose  
storage bag  
Sac coffre de  
rangement multi  
usage

p. 385



p. 386

Regolatore  
altezza rete  
Support height  
adjuster  
Réglage  
hauteur  
sommier

p. 387



95

Tim



Tim  
- Reversible -

*Optional poggiatesta sospesi (Tim Soft).*  
*Optional suspended headrest (Tim Soft).*  
*En option des appuis-tête suspendus (Tim Soft).*





*Disponibile pratica sacca portaoggetti. Le diverse sezioni separate possono ospitare materiali di lettura... telefono... piccole gioie...*

*Practical storage bag available. The different sections can accommodate reading materials... phones... small jewellery...*

*Disponibile un sac porte-objets pratique. Les différentes sections séparées peuvent accueillir des livres et revues...téléphone...petits objets...*

**REVERSIBLE:** è sempre possibile cambiare verso al rivestimento della testiera che è uguale fronte - retro. In questo esempio con tessuto puntinato con texture di microfori.

Il rivestimento è aperto leggermente agli angoli superiori e arricchito ai lati da stretti bordi di stoffa a volant e a contrasto, presenti a segnare anche gli angoli del giroletto.

**REVERSIBLE:** you can always change side to the cover, which is the same on the front and back. In this example with fabric dotted by micro-holes. The cover is slightly open at the top corners and enriched on the sides by narrow edges of fabric with frills and contrasting, that marks the bed frame also on the corners.

**REVERSIBLE:** possibilité de changer le côté de revêtement qui est identique des deux côtés.

Dans le modèle présenté le tissu est perforé avec une texture de micro-perforation.

Le revêtement est légèrement ouvert aux angles supérieurs et enrichi sur les côtés par d'étroits bords en tissu à volant en couleur contrastée, couleurs qui marquent aussi les bords du tour de lit.





*Testiera essenziale e leggera, razionale nel disegno e negli spessori.*  
*Nb: tessuto traforato disponibile solo su tessuto Sissy nelle versioni colore della tirella Samuel.*



*Essential and light headboard, rational in the design and thicknesses.*  
*Note: perforated fabric only available on Sissy fabric in the colors of fabric hanger Samuel.*

*Tête de lit essentielle et légère, au dessin et aux épaisseurs rationnels.*  
*Nb: tissu perforé disponible uniquement sur tissu Sissy dans les couleurs de la tirelle Samuel.*







# Tim

Completamente sfoderabile  
Totally removable cover  
Complètement déhoussable

\*  
Rete L. 180 cm  
solo profondità 200 cm  
Support W. 180 cm  
only D 200 cm  
Sommier L. 180 cm  
uniquement en  
profondeur 200 cm

### Caratteristiche tecniche

**Masselli** in legno di abete e/o scatolati in multistrato di legno di pioppo. **Pannelli** da 18/25 mm in particelle di legno di pioppo in classe E1 a bassa emissione di formaldeide e fibra di legno naturale. **Espansi** di poliuretano indeformabile a portanza differenziata, densità da 18 kg/mc a 40 kg/mc.

**Primo rivestimento** in espanso di poliestere accoppiato a caldo a vellutino aggrappante in poliestere e/o ovatta di poliestere al 100% da 200gr. **Pannelli fondo** contenitore da 12-14 mm in particelle di legno di pioppo in classe E1.

### Technical characteristics

**Forgings** fir wood, and/or boxed in poplar plywood. **Panels** 18/25 mm in poplar wood particles class E1 low formaldehyde emission and natural wood fiber.

**Polyurethane foam**, crushproof, of different capacity, density from 18 kg/mc to 40 kg/mc.

**First coating** hot bonded polyester foam, velvet adhesion in polyester and/or 100% polyester wool, 200gr. **Container bottom panels** 12-14 mm in poplar wood particles class E1.

### Caractéristiques techniques

**Tige** en pin et/ou boitiers en multicouche en bois de peuplier.

**Panneaux** de 18/25 mm en particules de bois de peuplier classe E1 à faible émission de formaldéhyde et fibre de bois naturelle. **Polyuréthane expansé** indéformable à portée différenciée, densité de 18kg/m<sup>2</sup> à 40kg/m<sup>2</sup>.

**Premier revêtement** en polyester expansé accouplé à chaud à un velours accrochant en polyester et/ou ouate de polyester à 100% de 200g.

**Panneaux de fond coffre rangement** de 12-14mm en particules de bois de peuplier classe E1.

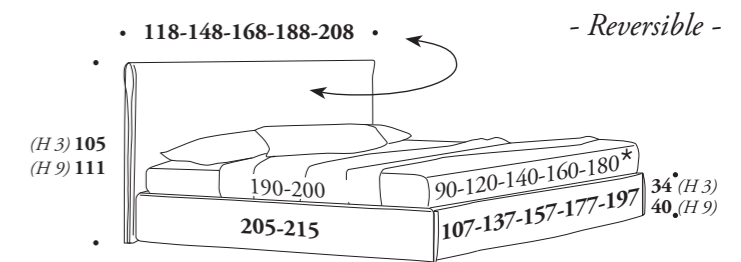

## Ring Smart



Standard  
Basic  
H 3 cm

wengé  
wengé  
wengé

Varianti colore / Color variants / Couleurs disponibles

nero  
black  
noir

bianco  
white  
blanc

argento  
silver  
argent

Lux  
H 3 cm

wengé  
wengé  
wengé

nero  
black  
noir

bianco  
white  
blanc

cromo  
chrome  
chrome

Optional

Visual  
H 9 cm

wengé  
wengé  
wengé

nero  
black  
noir

bianco  
white  
blanc

argento  
silver  
argent

## Tim Soft

Optional poggiatesta sospesi.  
Le dimensioni e il numero dei cuscini saranno diversi in proporzione alla testata.

Optional suspended headrest.  
The size and the number of cushions will be different in proportion to the headboard.

En option les appuie-têtes suspendus.  
Les dimensions et le nombre de coussins sont différents en fonction de la tête de lit.



Optional  
Accessori  
Accessories  
Accessoires

Panquette  
Panquette  
Panquette



p. 370

Pouf con  
contenitore  
Pouf with  
container  
Pouf avec  
rangement



p. 368

Sacca  
portaoggetti  
Storage bag  
Sac porte-objets



p. 375

Meccanica / Mechanism / Mécanique p. 382

Rete / Support / Sommier p. 380



110

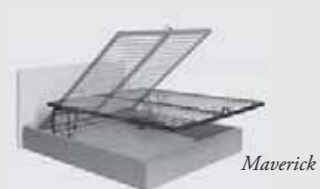

Maverick



Armony

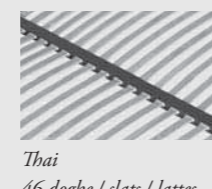

Thai  
46 doghe / slats / lattes



Energy

Non applicabile a rete da 120 cm  
Not applicable to 120 cm support  
Non applicable au sommier de 120 cm

Tessuto coprirete  
traspirante antipolvere  
Support cover fabric  
breathable and dustproof  
Tissu couvre-sommier  
transpirant anti-poussière

p. 384

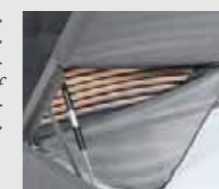

Sacco contenitore  
Multiuso  
Multipurpose  
storage bag  
Sac coffre de  
rangement multi  
usage

p. 385



p. 386

Regolatore  
altezza rete  
Support height  
adjuster  
Réglage  
hauteur  
sommier

p. 387



111

# Night *of* nights

*A complete bedroom collection by Felis*

*La leggenda narra di una terra misteriosa e meravigliosa formata da valli e colline alberate. Quella terra è popolata da lune, grandi e sferiche che si spostano sull'erba rotolando e di notte si innalzano e passeggiano nel cielo. Le lune però non si muovono in gruppo, ma sono solitarie e non sanno che vanno incontro ad un gigante che vive fuori dalla valle, che le afferra ed ogni notte, con il suo coltello, ne taglia una fetta finché non rimane più nulla tranne un numero grande di schegge, che il gigante getta nel cielo trasformandole in stelle. Questi frammenti di luna durante il giorno si nascondono, intimorite dal sole, mentre di notte escono fuori per giocare.*

*Soli, lune e stelle racconto appartenente alla leggende aborigene.*

*The legend tells of a mysterious and wonderful land formed by valleys and wooded hills. That land is populated by moons, large and spherical, that move and roll on the grass and rise and walk in the sky at night. The moons do not move in groups, but they are lonely and do not know that they face a giant who lives out of the valley, that grabs them every night and cuts a slice off them with his knife, until nothing remains except a large number of fragments, that the giant throws into the sky turning them into stars. These fragments of the moon hide during the day, frightened by the sun, while at night they come out to play.*

*Suns, moons and stars story belonging to the Aboriginal legends.*

*La légende parle d'une terre mystérieuse et merveilleuse formée de vallées et de collines arborées. Cette terre est peuplée de lunes, grandes, rondes, qui se déplacent sur l'herbe en roulant et la nuit elle se dressent et se promènent dans le ciel. Les lunes ne se déplacent pas en groupe, mais sont solitaires et elle se savent pas qu'elles vont à la rencontre d'un géant qui vit hors de la vallée, et qui chaque nuit prend une lune et avec son couteau, il en coupe une tranche jusqu'à ce qu'il ne reste plus rien si ce n'est qu'un grand nombre d'éclats, que le géant jette dans le ciel et les transforment en étoiles. Ces éclats de lune, pendant la journée se cachent, effrayés par le soleil, et la nuit ils sortent pour jouer.*

*Les soleils, les lunes et les étoiles est une légende aborigène.*



Chris





Chris



*La particolare forma di testiera e ring accentua l'idea di contenimento del piano letto. I due bottoni uniti da una originale finitura umanizzano e ammorbidiscono Chris.*



*The particular form of the headboard and ring accentuates the containment of the bed. The two buttons joined by an original finish humanize and soften Chris.*

*La forme particulière de la tête de lit et du tour de lit accentue l'idée de contention du lit. Les deux boutons et la finition originale adoucissent et humanise Chris.*





*Una proposta con una sua identità precisa  
a suo agio in qualunque interno, classico,  
moderno, post moderno...*

*A proposal with its own identity, suitable  
for any design style, classic, modern, post-  
modern...*

*Une proposition avec une identité précise,  
parfaite pour tous les intérieurs, classique,  
moderne, post-moderne...*





*I bottoni da Ø 27 possono essere rivestiti in tessuto, in tinta o a contrasto. In alternativa è disponibile anche la proposta Swarovski in evidenza con le piccole pieghe preziose del tessuto.*

*The buttons from Ø 27 can be covered with fabric, matching or contrasting. Alternatively, there is also a version with Swarovski crystals that highlight the small and precious folds of the fabric.*

*Les boutons de Ø 27 peuvent être revêtus de tissu, de la même couleur ou d'une autre couleur pour créer un contraste. En alternative, la proposition Swarovski, mise en évidence par les petits plis précieux du tissu.*

## Chris

Completamente sfoderabile  
Totally removable cover  
Complètement déhoussable

\*  
Rete L. 180 cm  
solo profondità 200 cm  
Support W. 180 cm  
only D 200 cm  
Sommier L. 180 cm  
uniquement en  
profondeur 200 cm

**Caratteristiche tecniche**  
**Masselli** in legno di abete e/o scatolati in multistrato di legno di pioppo. **Pannelli** da 18/25 mm in particelle di legno di pioppo in classe E1 a bassa emissione di formaldeide e fibra di legno naturale. **Espansi** di poliuretano indeformabile a portanza differenziata, densità da 18 kg/mc a 40 kg/mc.  
**Primo rivestimento** in espanso di poliestere accoppiato a caldo a vellutino aggrappante in poliestere e/o ovatta di poliestere al 100% da 200gr. **Pannelli fondo** contenitore da 12-14 mm in particelle di legno di pioppo in classe E1.

**Technical characteristics**  
**Forgings** fir wood, and/or boxed in poplar plywood. **Panels** 18/25 mm in poplar wood particles class E1 low formaldehyde emission and natural wood fiber. **Polyurethane foam**, crushproof, of different capacity, density from 18 kg/mc to 40 kg/mc.  
**First coating** hot bonded polyester foam, velvet adhesion in polyester and/or 100% polyester wool, 200gr. **Container bottom panels** 12-14 mm in poplar wood particles class E1.

**Caractéristiques techniques**  
**Tige** en pin et/ou boitiers en multicouche en bois de peuplier. **Panneaux** de 18/25 mm en particules de bois de peuplier classe E1 à faible émission de formaldéhyde et fibre de bois naturelle. **Polyuréthane expansé** indéformable à portée différenciée. densité de 18kg/m<sup>2</sup> à 40kg/m<sup>2</sup>.  
**Premier revêtement** en polyester expansé accouplé à chaud à un velours accrochant en polyester et/ou ouate de polyester à 100% de 200g. **Panneaux de fond coffre rangement** de 12-14mm en particules de bois de peuplier classe E1.

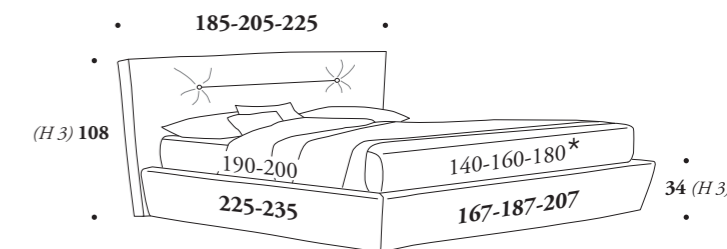

## Ring Climb



### Standard

Basic  
H 3 cm



### Varianti colore / Varianti colore / Varianti colore



### Optional

Lux  
H 3 cm



*Bottoni tinta unita come il tessuto o a contrasto o Swarovski bianco  
Buttons in the same color as the fabric or contrasting or white Swarovski  
Boutons couleur tissu ou en contraste ou Swarovski blanc*

### Optional

Accessori  
Accessoires

Panquette  
Panquette



p. 370

Pouf con  
contenitore  
Pouf with  
container  
Pouf avec  
rangement



p. 368

Sacca  
portaoggetti  
Storage bag  
Sac porte-objets



p. 375

Meccanica / Mechanism / Mécanique p. 382



Dynamic

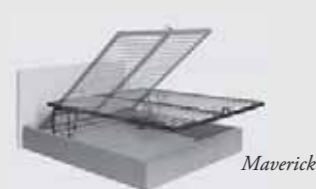

Maverick

124

Rete / Support / Sommier p. 380



Armony

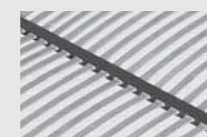

Thai  
46 doghe / slats / lattes

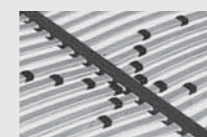

Energy

Non applicabile a rete da 120 cm  
Not applicable to 120 cm support  
Non applicable au sommier de 120 cm

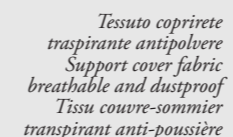

Tessuto coprirete  
traspirante antipolvere  
Support cover fabric  
breathable and dustproof  
Tissu couvre-sommier  
transpirant anti-poussière

p. 384

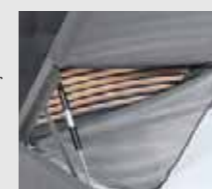

Sacco contenitore  
Multiuso  
Multipurpose  
storage bag  
Sac coffre de  
rangement multi  
usage

p. 385

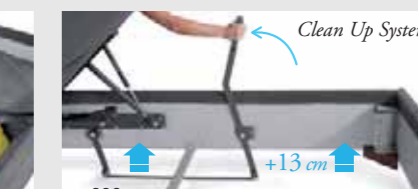

p. 386

Regolatore  
altezza rete  
Support height  
adjuster  
Réglage  
hauteur  
sommier



p. 387

125



# Scotty





# Scotty

- Relax System -

*Una rappresentazione dei cuscini più classici ma ingranditi e umanizzati con ironia a formato testiera.*

**Relax System**

*Grazie all'innovativa soluzione dei cuscini reclinabili molte testiere sono relax system, consentono cioè una comoda posizione "seduta" e un pratico appoggio di sostegno per leggere, guardare la tv, lavorare al laptop...*

*A representation of the cushions, more classic but magnified and humanized with irony to become a headboard.*

**Relax System**

*With the innovative solution of the headboard cushions, many headboards become relaxation systems, that is, allow a comfortable position while "sitting" and a practical support for reading, watching TV, working on laptop...*

*Une représentation des coussins plus classiques mais agrandis et humanisés avec ironie au format de la tête de lit.*

**Relax System**

*Grâce à la solution innovante des coussins tête de lit inclinable, de nombreuses tête de lits sont « relax system », elles permettent d'avoir une position assise commode et un appui pratique pour lire, regarder la télé, travailler avec l'ordinateur portable...*

*- Relax System -*





*Il bordo a contrasto ha un impatto estetico preciso e forte. Delinea i bordi dei cuscini e della struttura del letto, ricreando un dettaglio stilistico e sartoriale, giovane e contemporaneo.*

*The contrasting edge has a precise and strong aesthetic impact. It outlines the edges of the cushions and bed structure, creating a stylistic and tailoring detail, young and contemporary.*

*Les bord en contraste a un impact esthétique précis et fort. Il dessine les bords des coussins et de la structure du lit, et recrée un détail stylé et haute couture, jeune et contemporain.*



Portagioie p. 376  
Jewelry Box - Porte-bijoux



Porta USB p. 377  
USB holder - Port USB



## Scotty

Completamente sfoderabile  
Totally removable cover  
Complètement déhoussable

\*  
Rete L. 180 cm  
solo profondità 200 cm  
Support W. 180 cm only  
D 200 cm  
Sommier L. 180 cm  
uniquement en  
profondeur 200 cm

**Caratteristiche tecniche**  
**Masselli** in legno di abete e/o scatolati in multistrato di legno di pioppo. **Pannelli** da 18/25 mm in particelle di legno di pioppo in classe E1 a bassa emissione di formaldeide e fibra di legno naturale. **Espansi** di poliuretano in densità da 18 kg/mc a 40 kg/mc. **Cuscini** rivestiti in ovatta da 300 gr. **Primo rivestimento** in espanso di poliestere accoppiato a caldo a vellutino aggrappante in poliestere e/o ovatta di poliestere al 100% da 200gr. **Pannelli fondo** contenitore da 12-14 mm in particelle di legno di pioppo in classe E1.

**Technical characteristics**  
**Forgings** fir wood, and/or boxed in poplar plywood. **Panels** 18/25 mm in poplar wood particles class E1 low formaldehyde emission and natural wood fiber. **Polyurethane foam** density from 18 kg/mc to 40 kg/mc. **Cushions** coated with 300 gr wadding. **First coating** hot bonded polyester foam, velvet adhesion in polyester and/or 100% polyester wool, 200gr. **Container bottom panels** 12-14 mm in poplar wood particles class E1.

**Caractéristiques techniques**  
**Tige** en pin et/ou boîtiers en multicouche en bois de peuplier. **Panneaux** de 18/25 mm en particules de bois de peuplier classe E1 à faible émission de formaldéhyde et fibre de bois naturelle. **Polyuréthane expansé** densité de 18kg/m<sup>2</sup> à 40kg/m<sup>2</sup>. **Coussin** rembourrés avec de la ouate de 300g. **Premier revêtement** en polyester expansé accouplé à chaud à un velours accrochant en polyester et/ou ouate de polyester à 100% de 200g. **Panneaux de fond coffre rangement** de 12-14mm en particules de bois de peuplier classe E1.

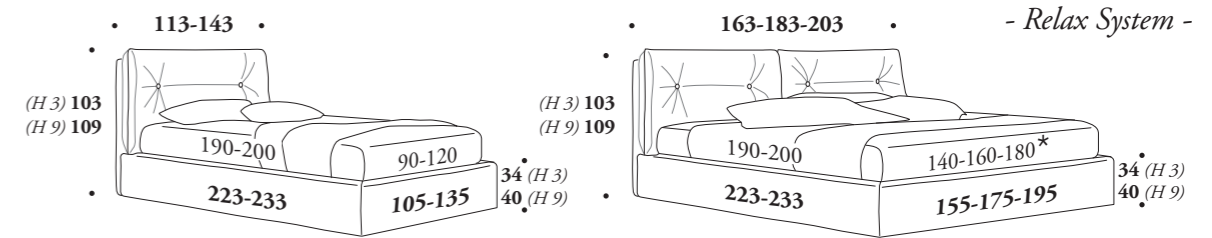

### Ring Eko



### Ring Liberty



### Standard

Basic  
H 3 cm



### Varianti colore / Color variants / Couleurs disponibles

nero  
black  
noir



bianco  
white  
blanc



argento  
silver  
argent



Lux  
H 3 cm



nero  
black  
noir



bianco  
white  
blanc



cromo  
chrome  
chrome



Optional  
Visual  
H 9 cm



nero  
black  
noir



bianco  
white  
blanc



argento  
silver  
argent

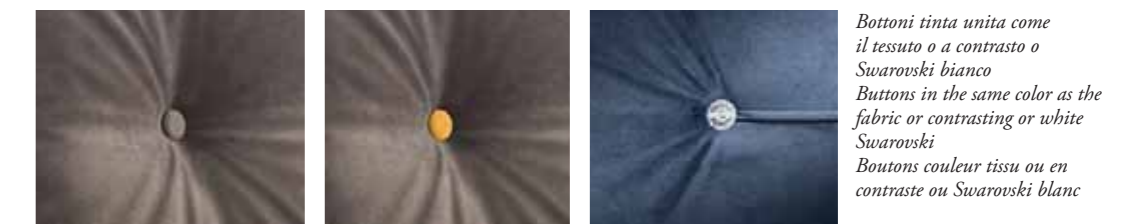

Bottoni tinta unita come il tessuto o a contrasto o Swarovski bianco  
Buttons in the same color as the fabric or contrasting or white Swarovski  
Boutons couleur tissu ou en contraste ou Swarovski blanc

### Optional Accessori Accessoires

Panquette  
Panquette



p. 370

Pouf con  
contenitore  
Pouf with  
container  
Pouf avec  
rangement



p. 368

Sacca  
portaoggetti  
Storage bag  
Sac porte-objets



p. 375

### Meccanica / Mechanism / Mécanique p. 382



132

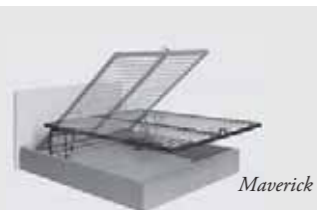

Maverick

### Rete / Support / Sommier p. 380

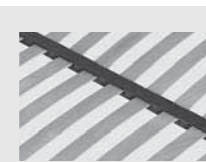

Armony

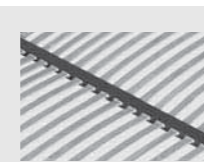

Thai  
46 doghe / slats / lattes

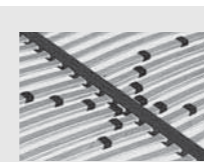

Energy  
Non applicabile a rete da 120 cm  
Not applicable to 120 cm support  
Non applicable au sommier de 120 cm

Tessuto coprirete  
traspirante antipolvere  
Support cover fabric  
breathable and dustproof  
Tissu couvre-sommier  
transpirant anti-poussière

p. 384

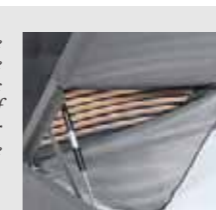

Sacco contenitore  
Multipurpose  
storage bag  
Sac coffre de  
rangement multi  
usage

p. 385

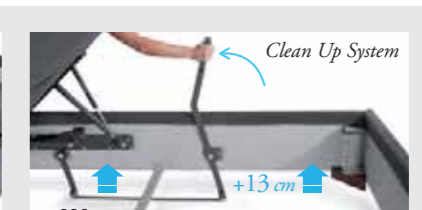

p. 386

Regolatore  
altezza rete  
Support height  
adjuster  
Réglage  
hauteur  
sommier

p. 387



133

Vern





Vern

*Ci sono linee e forme eterne.*

*Una fascia cucita incornicia e circonda la testiera, evidenziando lo spessore.*

*There are eternal lines and forms.*

*A stitched band frames and surrounds the headboard, highlighting its thickness.*

*Il y a des lignes et des formes éternelles.*

*Une bande cousue encadre et entoure la tête de lit, pour mettre en évidence l'épaisseur.*









*Il particolare prezioso della gonnella a volant. Questa lavorazione sartoriale muove la superficie molto minimal di Vern.*

*The precious detail of the skirt with frills. This kind of processing moves the very minimal surface of Vern.*

*Le précieux détail de la jupe à volant. Cette réalisation haute couture crée un mouvement minimaliste au modèle Vern.*



## Vern

Completamente sfoderabile  
Totally removable cover  
Complètement déhoussable

\*  
Rete L. 180 cm  
solo profondità 200 cm  
Support W. 180 cm only  
D 200 cm  
Sommier L. 180 cm  
uniquement en  
profondeur 200 cm

### Caratteristiche tecniche

**Masselli** in legno di abete e/o sciolati in multistrato di legno di pioppo. **Pannelli** da 18/25 mm in particelle di legno di pioppo in classe E1 a bassa emissione di formaldeide e fibra di legno naturale. **Espansi** di poliuretano indeformabile a portanza differenziata, densità da 18 kg/mc a 40 kg/mc.

**Primo rivestimento** in espanso di poliestere accoppiato a caldo a vellutino aggrappante in poliestere e/o ovatta di poliestere al 100% da 200gr. **Pannelli fondo** contenitore da 12-14 mm in particelle di legno di pioppo in classe E1.

### Technical characteristics

**Forgings** fir wood, and/or boxed in poplar plywood. **Panels** 18/25 mm in poplar wood particles class E1 low formaldehyde emission and natural wood fiber.

**Polyurethane foam**, crushproof, of different capacity, density from 18 kg/mc to 40 kg/mc.

**First coating** hot bonded polyester foam, velvet adhesion in polyester and/or 100% polyester wool, 200gr. **Container bottom panels** 12-14 mm in poplar wood particles class E1.

### Caractéristiques techniques

**Tige** en pin et/ou boitiers en multicouche en bois de peuplier.

**Panneaux** de 18/25 mm en particules de bois de peuplier classe E1 à faible émission de formaldéhyde et fibre de bois naturelle. **Polyuréthane expansé** indéformable à portée différenciée. densité de 18kg/m<sup>2</sup> à 40kg/m<sup>2</sup>.

**Premier revêtement** en polyester expansé accouplé à chaud à un velours accrochant en polyester et/ou ouate de polyester à 100% de 200g.

**Panneaux de fond coffre rangement** de 12-14mm en particules de bois de peuplier classe E1.

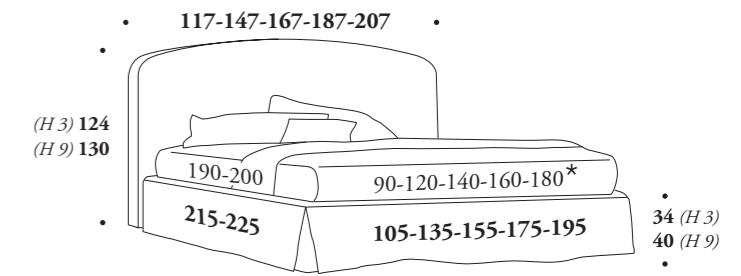

## Ring Smart



## Ring Venice



### Standard

Basic  
H 3 cm

wengé  
wengé  
wengé



### Varianti colore / Color variants / Couleurs disponibles

nero  
black  
noir



bianco  
white  
blanc



argento  
silver  
argent



Lux  
H 3 cm

wengé  
wengé  
wengé



nero  
black  
noir



bianco  
white  
blanc



cromo  
chrome  
chrome



Optional

Visual  
H 9 cm

wengé  
wengé  
wengé



nero  
black  
noir



bianco  
white  
blanc



argento  
silver  
argent



### Optional

Accessori  
Accessoires

Panquette  
Panquette  
Panquette



p. 370

Pouf con  
contenitore  
Pouf with  
container  
Pouf avec  
rangement



p. 368

Sacca  
portaoggetti  
Storage bag  
Sac porte-objets



p. 375

Meccanica / Mechanism / Mécanique p. 382

Rete / Support / Sommier p. 380



Dynamic

142



Maverick



Armony

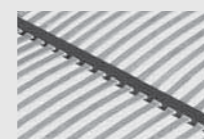

Thai  
46 doghe / slats / lattes

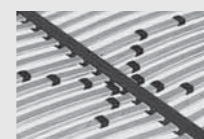

Energy  
Non applicabile a rete da 120 cm  
Not applicable to 120 cm support  
Non applicable au sommier de 120 cm

Tessuto coprirete  
traspirante antipolvere  
Support cover fabric  
breathable and dustproof  
Tissu couvre-sommier  
transpirant anti-poussière

p. 384



Sacco contenitore  
Multiuso  
Multipurpose  
storage bag  
Sac coffre de  
rangement multi  
usage

p. 385



p. 386

Regolatore  
altezza rete  
Support height  
adjuster  
Réglage  
hauteur  
sommier

p. 387



143

# Night *of* nights

*A complete bedroom collection by Felis*

***Il sonno come alleato della bellezza.***

*Il buon sonno è anche un vero e proprio alleato della bellezza non solo perché migliora i tratti del viso e l'espressione di relax generale ma anche perché agisce sul peso corporeo. Non a caso i centri benessere prevedono aree dedicate al riposo e al relax.*

***Sleep as an ally of beauty.***

*Good sleep is also a true ally of beauty, not only because it improves the facial features and the expression of general relaxation, but also because it acts on the body weight. It is no coincidence that Spas provide areas dedicated to rest and relaxation.*

***Le sommeil: un allié de beauté.***

*Un bon sommeil est un vrai allié pour la beauté, pas seulement parce qu'il améliore les traits du visage et donne une expression reposée mais aussi parce qu'il agit sur le poids. C'est pour cela que les centres de bien-être ont des zones dédiées au repos et au relax.*



# T Jason





Jason



***Lo stile interpreta**  
a modo suo una tendenza  
classica. Per vivere all'insegna  
dell'eleganza oltre che del  
comfort.*

***Style reinterprets** a classic  
trend in its own way.  
To live with elegance and  
comfort.*

***Le style interprète** à sa  
manière une tendance classique.  
Pour vivre sous le signe de  
l'élégance en plus du confort.*





*Il ring riprende il tema delle  
rotondità classiche e morbide  
della testiera.*

*The ring reprises the theme of  
the classic and soft roundness  
of the headboard.*

*Le cadre de lit reprend  
le thème des rondeurs  
classiques et moelleuses de la  
tête de lit.*

## Jason

Completamente sfoderabile  
Totally removable cover  
Complètement déhoussable

### Caratteristiche tecniche

**Masselli** in legno di abete e/o  
scatolati in multistrato di legno di  
pioppo. **Pannelli** da 18/25 mm  
in particelle di legno di pioppo  
in classe E1 a bassa emissione  
di formaldeide e fibra di legno  
naturale. **Espansi** di poliuretano  
indeformabile a portanza  
differenziata, densità da 18 kg/  
mc a 40 kg/mc.

**Primo rivestimento** in espanso  
di poliesteri accoppiato a caldo  
a vellutino aggrappante in  
poliesteri e/o ovatta di poliesteri  
al 100% da 200gr. **Pannelli  
fondo** contenitore da 12-14 mm  
in particelle di legno di pioppo in  
classe E1.

### Technical characteristics

**Forgings** fir wood, molded  
poplar plywood. **Panels** 18/25  
mm in poplar wood particles  
class E1 low formaldehyde  
emission and natural wood fiber.  
**Polyurethane foam**, crushproof,  
of different capacity, density from  
18 kg/mc to 40 kg/mc.

**First coating** hot bonded  
polyester foam, velvet adhesion  
in polyester and/or 100%  
polyester wool, 200gr. **Container  
bottom panels** 12-14 mm in  
poplar wood particle class E1.

### Caractéristiques techniques

**Tige** en pin, cadre en  
multicouche de peuplier  
**Panneaux** de 18/25 mm en  
particules de bois de peuplier  
classe E1 à faible émission  
de formaldéhyde et fibre de  
bois naturelle. **Polyuréthane  
expansé** indéformable à portée  
différenciée, densité de 18kg/m<sup>2</sup>  
à 40kg/m<sup>2</sup>.

**Premier revêtement** en  
polyester expansé accouplé à  
chaud à un velours accrochant  
en polyester et/ou ouate de  
polyester à 100% de 200g.

**Panneaux de fond coffre  
rangement** de 12-14mm en  
particules de bois de peuplier  
classe E1.

\*  
Rete L. 180 cm  
solo profondità 200 cm  
Support W. 180 cm  
only D 200 cm  
Sommier L. 180 cm (H 3) 140  
uniquement en  
profondeur 200 cm

198-218-238

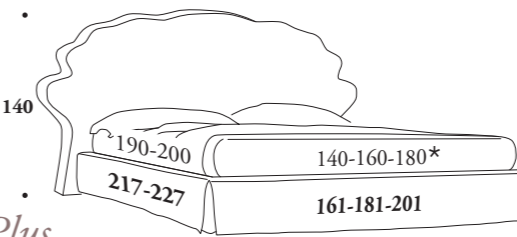

198-218-238

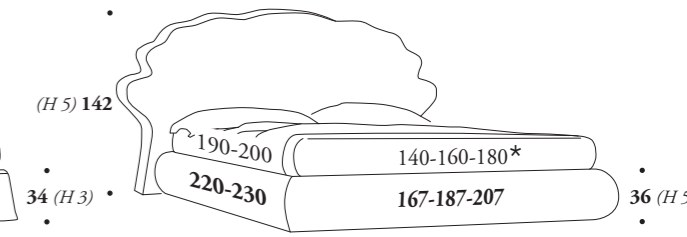

## Ring Venice Plus



### Standard

#### Basic

H 3 cm



### Varianti colore / Color variants / Couleurs disponibles



### Optional

#### Lux

H 3 cm



## Ring Big



### Standard

#### Classic

H 5 cm



### Varianti colore / Color variants / Couleurs disponibles



## Ring Chic



### Standard

#### Mozart

H 13 cm



### Varianti colore / Color variants / Couleurs disponibles



### Optional

Accessori  
Accessories  
Accessoires

Panquette  
Panquette  
Panquette



p. 370

Panquette con  
contenitore  
Panquette with  
container  
Panquette avec  
rangement



p. 368

Sacca  
portaoggetti  
Storage bag  
Sac porte-objets



p. 375

Meccanica / Mechanism / Mécanique p. 382



Dynamic



Maverick

152

Rete / Support / Sommier p. 380



Armony

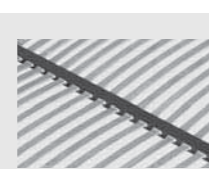

Thai  
46 doghe / slats / lattes

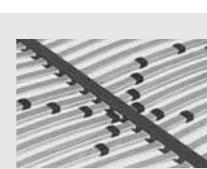

Energy

Non applicabile a rete da 120 cm  
Not applicable to 120 cm support  
Non applicable au sommier de 120 cm

Tessuto coprirete  
traspirante antipolvere  
Support cover fabric  
breathable and dustproof  
Tissu couvre-sommier  
transpirant anti-poussière

p. 384

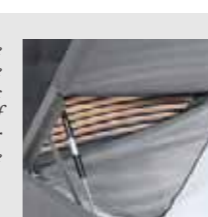

Sacco contenitore  
multiuso  
Multipurpose  
storage bag  
Sac coffre de  
rangement multi  
usage

p. 385



p. 386

Regolatore  
altezza rete  
Support height  
adjuster  
Réglage  
hauteur  
sommier

p. 387



153

Oscar





Oscar



*Le linee essenziali citano forme al di là del tempo...  
La cornice diventa un importante elemento a sé,  
che caratterizza la testiera scelta.*

*The essentials lines refer to forms beyond time...  
The frame becomes an important element in itself  
that characterizes the chosen headboard.*

*Lignes essentielles hors du temps...le cadre devient  
un élément important qui caractérise la tête de lit  
choisie.*





Liscio / Smooth / Lisse



Nuvola / Cloud / Nuage



Bottone / Matching / Bouton

**Una cornice unica...**  
la possibilità di testiere diverse sia nel colore (della cornice) sia nella lavorazione. Dalla più semplice e liscia (1) a quelle effetto capitonné senza bottone (2) o con bottone in tinta (3) o a contrasto (4). Anche con bottoni Swarovski Kristal (5) o nero (6) per una proposta articolata...

**A unique frame...**  
the possibility of different headboards, both in the color (of the frame) and in the processing. From the most simple and smooth (1) to those with a quilted effect without buttons (2) or with matching (3) or contrasting button (4). Also with Swarovski Kristal (5) or black (6) buttons for a detailed proposal...



Bottoni a contrasto / Contrasting buttons / Bouton couleur différente



Swarovski Kristal



Swarovski nero / black / noir

**Un cadre unique...**  
choix de têtes de lit différentes pour la couleur (du cadre) et pour la réalisation. De la plus simple et lisse (1) à celle capitonnée sans boutons (2) ou avec bouton de la même couleur (3) ou de couleur différente pour créer un contraste (4). Disponible avec boutons Swarovski Kristal (5) ou noir (6) pour une version structurée.



*Il pannello testiera sfoderabile come tutta la collezione è anche completamente intercambiabile con una delle altre versioni un domani... in futuro...*

*The headboard panel is removable, like the whole collection, and it is also fully interchangeable with one of the other versions...*

*Le panneau de la tête de lit est déhoussable comme toute la collection et entièrement interchangeable avec une des autres versions... pour en changer un jour...*

## Oscar

Completamente sfoderabile  
Totally removable cover  
Complètement déhoussable

\*  
Rete L. 180 cm  
solo profondità 200 cm  
Support W. 180 cm  
only D 200 cm  
Sommier L. 180 cm  
uniquement en  
profondeur 200 cm

### Caratteristiche tecniche

**Masselli** in legno di abete e/o sciolati in multistrato di legno di pioppo. **Pannelli** da 18/25 mm in particelle di legno di pioppo in classe E1 a bassa emissione di formaldeide e fibra di legno naturale. **Espansi** di poliuretano indeformabile a portanza differenziata, densità da 18 kg/mc a 40 kg/mc.

**Primo rivestimento** in espanso di poliestere accoppiato a caldo a vellutino aggrappante in poliestere e/o ovatta di poliestere al 100% da 200gr. **Pannelli fondo** contenitore da 12-14 mm in particelle di legno di pioppo in classe E1.

### Technical characteristics

**Forgings** fir wood, and/or boxed in poplar plywood. **Panels** 18/25 mm in poplar wood particles class E1 low formaldehyde emission and natural wood fiber.

**Polyurethane foam**, crushproof, of different capacity, density from 18 kg/mc to 40 kg/mc.

**First coating** hot bonded polyester foam, velvet adhesion in polyester and/or 100% polyester wool, 200gr. **Container bottom panels** 12-14 mm in poplar wood particles class E1.

### Caractéristiques techniques

**Tige** en pin et/ou boitiers en multicouche en bois de peuplier.

**Panneaux** de 18/25 mm en particules de bois de peuplier classe E1 à faible émission de formaldéhyde et fibre de bois naturelle. **Polyuréthane expansé** indéformable à portée différenciée. densité de 18kg/m<sup>2</sup> à 40kg/m<sup>2</sup>.

**Premier revêtement** en polyester expansé accouplé à chaud à un velours accrochant en polyester et/ou ouate de polyester à 100% de 200g.

**Panneaux de fond coffre rangement** de 12-14mm en particules de bois de peuplier classe E1.

Tessuto coprirete  
traspirante antipolvere  
Support cover fabric  
breathable and dustproof  
Tissu couvre-sommier  
transpirant anti-poussière

p. 384



## Ring Smart plus



### Standard

Basic  
H 3 cm



### Varianti colore / Color variants / Couleurs disponibles



Optional

Lux  
H 3 cm

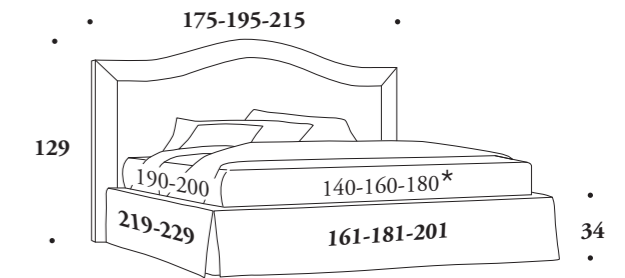

### Optional

Accessori  
Accessoires

Panquette  
Panquette



p. 370

Pouf con  
contenitore  
Pouf with  
container  
Pouf avec  
rangement



p. 368

Sacca  
portaoggetti  
Storage bag  
Sac porte-objets



p. 375

Meccanica / Mechanism / Mécanique p. 382

Rete / Support / Sommier p. 380



162

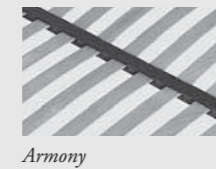
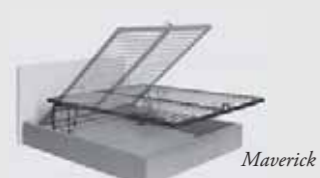

Armony

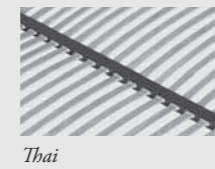

Thai  
46 doghe / slats / lattes

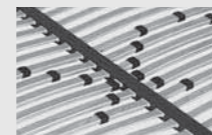

Energy

Non applicabile a rete da 120 cm  
Not applicable to 120 cm support  
Non applicable au sommier de 120 cm

Sacco contenitore  
Multiuso  
Multipurpose  
storage bag  
Sac coffre de  
rangement multi  
usage

p. 385



p. 386

Regolatore  
altezza rete  
Support height  
adjuster  
Réglage  
hauteur  
sommier

p. 387



163

# Rick



Woody  
Hito  
Perseo



Rick  
- Reversible -



**Rigorous and linear,  
minimalismo morbido...**

*Il disegno squadrato è segnato dal bordo pizzicato che delinea perfettamente i profili della testiera e del giroletto. Donando eleganza e comfort.*

**Rigorous and linear, soft  
minimalism...**

*The square design is marked by the pinched edge that perfectly outlines the profiles of the headboard and bed frame. Giving it elegance and comfort.*

**Rigoureuse et linéaire,  
minimalisme moelleux**

*Le dessin carré est marqué par un bord pincé qui limite parfaitement les profils de la tête de lit et du tour de lit. Et donne élégance et confort.*



*REVERSIBLE: è sempre possibile cambiare verso al rivestimento della testiera che è uguale fronte - retro.*

*REVERSIBLE: you can always change side to the cover, which is the same on the front and back.*

*RÉVERSIBLE: possibilité de changer le côté de revêtement qui est identique des deux côtés.*



**La testiera è bifacciale...**  
*Rick può vivere in centro stanza  
 oppure il rivestimento può  
 cambiare verso...*  
*per essere sempre perfetto...*

**The headboard is double sided...**  
*Rick can be placed  
 in the center of the room and  
 the cover can be reversed... to  
 always make it look perfect...*

**La tête de lit est double face...**  
*Rick peut se placer  
 au centre de la pièce ou le  
 revêtement peut changer de  
 côté... et il est toujours parfait.*

## Rick

Completamente sfoderabile  
 Totally removable cover  
 Complètement déhoussable

\*  
 Rete L. 180 cm  
 solo profondità 200 cm  
 Support W. 180 cm  
 only D 200 cm  
 Sommier L. 180 cm  
 uniquement en  
 profondeur 200 cm

**Caratteristiche tecniche**  
**Masselli** in legno di abete e/o  
 scatolati in multistrato di legno di  
 pioppo. **Pannelli** da 18/25 mm  
 in particelle di legno di pioppo  
 in classe E1 a bassa emissione  
 di formaldeide e fibra di legno  
 naturale. **Espansi** di poliuretano  
 indeformabile a portanza  
 differenziata, densità da 18 kg/  
 mc a 40 kg/mc.  
**Primo rivestimento** in espanso  
 di poliestere accoppiato a caldo  
 a vellutino aggrappante in  
 poliestere e/o ovatta di poliestere  
 al 100% da 200gr. **Pannelli  
 fondo** contenitore da 12-14 mm  
 in particelle di legno di pioppo in  
 classe E1.

**Technical characteristics**  
**Forgings** fir wood, and/or boxed  
 in poplar plywood. **Panels** 18/25  
 mm in poplar wood particles  
 class E1 low formaldehyde  
 emission and natural wood fiber.  
**Polyurethane foam**, crushproof,  
 of different capacity, density from  
 18 kg/mc to 40 kg/mc.  
**First coating** hot bonded  
 polyester foam, velvet adhesion  
 in polyester and/or 100%  
 polyester wool, 200gr. **Container  
 bottom panels** 12-14 mm in  
 poplar wood particles class E1.

**Caractéristiques techniques**  
**Tige** en pin et/ou boitiers en  
 multicouche en bois de peuplier.  
**Panneaux** de 18/25 mm en  
 particules de bois de peuplier  
 classe E1 à faible émission  
 de formaldéhyde et fibre de  
 bois naturelle. **Polyuréthane  
 expansé** indéformable à portée  
 différenciée. densité de 18kg/m²  
 à 40kg/m².  
**Premier revêtement** en  
 polyester expansé accouplé à  
 chaud à un velours accrochant  
 en polyester et/ou ouate de  
 polyester à 100% de 200g.  
**Panneaux de fond coffre**  
**rangement** de 12-14mm en  
 particules de bois de peuplier  
 classe E1.

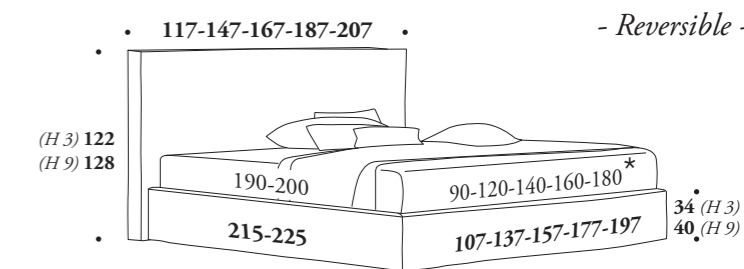

- Reversible -

## Ring Smart



### Standard

Basic  
 H 3 cm



### Varianti colore / Color variants / Couleurs disponibles



### Optional Accessori Accessoires



p. 370



p. 368



p. 375

Meccanica / Mechanism / Mécanique p. 382

Rete / Support / Sommier p. 380

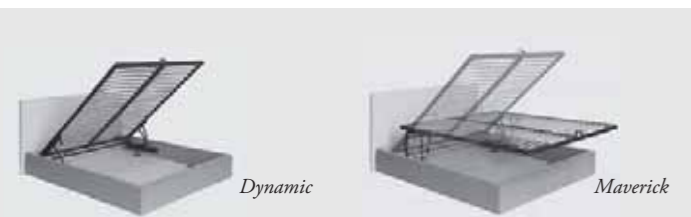

170



Armony

Thai

Energy

Non applicabile a rete da 120 cm  
 Not applicable to 120 cm support  
 Non applicable au sommier de 120 cm

Tessuto coprirete  
 traspirante antipolvere  
 Support cover fabric  
 breathable and dustproof  
 Tissu couvre-sommier  
 respirant anti-poussière

p. 384

Sacco contenitore  
 Multipurpose  
 storage bag  
 Sac coffre de  
 rangement multi  
 usage

p. 385



p. 386

Regolatore  
 altezza rete  
 Support height  
 adjuster  
 Réglage  
 hauteur  
 sommier

p. 387

171

# N Nelson







Nelson

- Double face -



***Il rivestimento della testiera è double face: diverso davanti e dietro. Per questo può essere girato tranquillamente fronte retro per un cambio di abbinamento... o di effetto colore... Particolari sartoriali caratteristici come il prezioso bordo a volant doppio.***

***The headboard cover is different on the front and back, for this reason, it be flipped for a different combination... or color effect... Characteristic details such as the precious edge with double frills.***

***Le revêtement de la tête de lit est différent devant et derrière, il peut donc être retourné pour changer de combinaison...ou d'effet de couleur... Des détails haute couture caractéristiques comme le bord précieux à double volant.***



*- Double face -*



1.



2.

**Parte frontale della testiera**  
*si accompagna nel colore al giroletto. La schiena e i lati che la circondano a cornice invece cambiano colore e si accompagnano a un decorativo bordo inferiore a contrasto, del giroletto. L'interno della gonnella può essere in tinta (1) o a contrasto (2).*

**The front of the headboard**  
*matches the color of the bed frame. The back and sides that surround it like a frame, on the other hand, change color and are accompanied by a decorative lower edge in contrast with the bed frame. The inside of the skirt can be in the same color (1) or contrasting (2).*

**La partie frontale de la tête de lit**  
*est assortie à la couleur du cadre de lit. Le dossier et les côtés qui l'encadrent ont une couleur différente et ils sont assortis au bord de couleur contrastée du cadre de lit. L'intérieur de la jupe peut être de la même couleur (1) ou d'une couleur contrastée (2).*

## Nelson

Completamente sfoderabile  
 Totally removable cover  
 Complètement déhoussable

\*  
 Rete L. 180 cm  
 solo profondità 200 cm  
 Support W. 180 cm  
 only D 200 cm  
 Sommier L. 180 cm  
 uniquement en  
 profondeur 200 cm

**Caratteristiche tecniche**  
**Masselli** in legno di abete e/o scatolati in multistrato di legno di pioppo. **Pannelli** da 18/25 mm in particelle di legno di pioppo in classe E1 a bassa emissione di formaldeide e fibra di legno naturale. **Espansi** di poliuretano indeformabile a portanza differenziata, densità da 18 kg/mc a 40 kg/mc.  
**Primo rivestimento** in espanso di poliestere accoppiato a caldo a vellutino aggrappante in poliestere e/o ovatta di poliestere al 100% da 200gr. **Pannelli fondo** contenitore da 12-14 mm in particelle di legno di pioppo in classe E1.

**Technical characteristics**  
**Forgings** fir wood, and/or boxed in poplar plywood. **Panels** 18/25 mm in poplar wood particles class E1 low formaldehyde emission and natural wood fiber. **Polyurethane foam**, crushproof, of different capacity, density from 18 kg/mc to 40 kg/mc.  
**First coating** hot bonded polyester foam, velvet adhesion in polyester and/or 100% polyester wool, 200gr. **Container bottom panels** 12-14 mm in poplar wood particles class E1.

**Caractéristiques techniques**  
**Tige** en pin et/ou boitiers en multicouche en bois de peuplier. **Panneaux** de 18/25 mm en particules de bois de peuplier classe E1 à faible émission de formaldéhyde et fibre de bois naturelle. **Polyuréthane expansé** indéformable à portée différenciée, densité de 18kg/m<sup>2</sup> à 40kg/m<sup>2</sup>.  
**Premier revêtement** en polyester expansé accouplé à chaud à un velours accrochant en polyester et/ou ouate de polyester à 100% de 200g. **Panneaux de fond coffre** rangement de 12-14mm en particules de bois de peuplier classe E1.

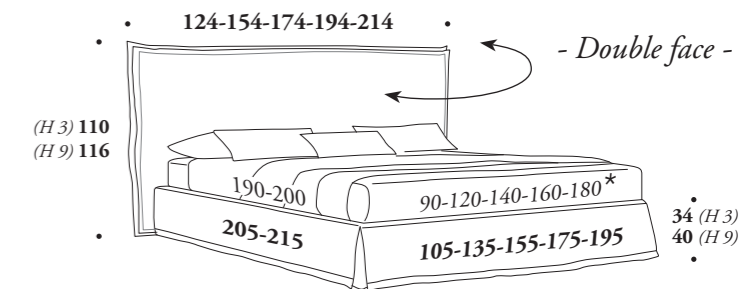

### Ring Venice 1

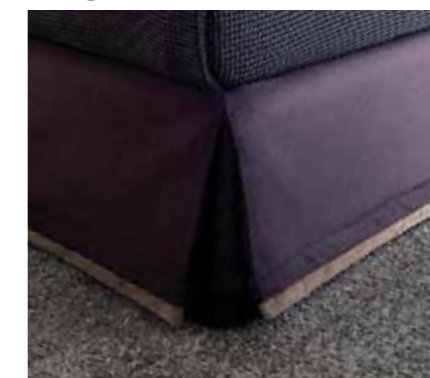

### Ring Venice 2



#### Standard

##### Basic

H 3 cm



#### Varianti colore / Color variants / Couleurs disponibles



#### Lux

H 3 cm



#### Optional

##### Visual

H 9 cm



#### Optional

Accessori  
 Accessoires  
 Accessoires

Panquette  
 Panquette  
 Panquette



p. 370

Pouf con  
 contenitore  
 Pouf with  
 container  
 Pouf avec  
 rangement



p. 368

Sacca  
 portaoggetti  
 Storage bag  
 Sac porte-objets



p. 375

Meccanica / Mechanism / Mécanique p. 382



Dynamic

178

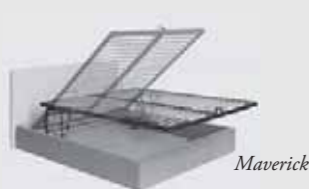

Maverick

Rete / Support / Sommier p. 380

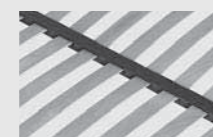

Armony

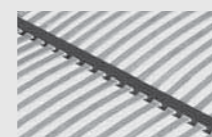

Thai  
 46 doghe / slats / lattes

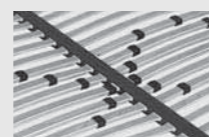

Energy  
 Non applicabile a rete da 120 cm  
 Not applicable to 120 cm support  
 Non applicable au sommier de 120 cm

Tessuto coprirete  
 traspirante antipolvere  
 Support cover fabric  
 breathable and dustproof  
 Tissu couvre-sommier  
 transpirant anti-poussière

p. 384

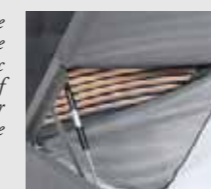

Sacco contenitore  
 Multipurpose  
 storage bag  
 Sac coffre de  
 rangement multi  
 usage

p. 385



p. 386

Regolatore  
 altezza rete  
 Support height  
 adjuster  
 Réglage  
 hauteur  
 sommier

p. 387



179

# E Emily





Emily



*Testiera moderna e minimale, con particolare lavorazione sartoriale “a federa”. I grandi cuscini indipendenti possono contenere i guanciali a riparo dalla polvere e sostenere posizioni più “sedute” e di comfort per la lettura, la tv.*



*Contemporary and minimal headboard, with particular “pillow case-like” processing. The large independent pillows can contain the night pillows to protect them from dust and allow more “seating” and comfort for reading and watching tv.*

*La tête de lit moderne et minimaliste, de type “oreiller” Les grands coussins indépendants peuvent maintenir les oreillers à l’abri de la poussière et avoir des positions plus “assises” et confortables pour la lecture, la télé.*





*Il giroletto elegante, a gonna con volant, può essere, all'interno, in tinta o a contrasto (optional).*

*The elegant bed frame, skirt-like with frills, can be, matching or contrasting on the inside (optional).*

*Le tour de lit élégant, à jupe à volant peut être, à l'intérieur, de la même couleur ou d'une couleur contrastée (optional).*



Portagioie p. 376  
Jewelry Box - Porte-bijoux



Porta USB p. 377  
USB holder - Port USB

## Emily

Completamente sfoderabile  
Totally removable cover  
Complètement déhoussable

\*  
Rete L. 180 cm  
solo profondità 200 cm  
Support W. 180 cm only  
D 200 cm  
Sommier L. 180 cm  
uniquement en  
profondeur 200 cm

### Caratteristiche tecniche

**Masselli** in legno di abete e/o scatolati in multistrato di legno di pioppo. **Pannelli** da 18/25 mm in particelle di legno di pioppo in classe E1 a bassa emissione di formaldeide e fibra di legno naturale. **Espansi** di poliuretano in densità da 18 kg/mc a 40 kg/mc. **Cuscini** rivestiti in ovatta da 300 gr. **Primo rivestimento** in espanso di poliestere accoppiato a caldo a vellutino aggrappante in poliestere e/o ovatta di poliestere al 100% da 200gr. **Pannelli fondo** contenitore da 12-14 mm in particelle di legno di pioppo in classe E1.

### Technical characteristics

**Forgings** fir wood, and/or boxed in poplar plywood. **Panels** 18/25 mm in poplar wood particles class E1 low formaldehyde emission and natural wood fiber. **Polyurethane foam** density from 18 kg/mc to 40 kg/mc. **Cushions** coated with 300 gr wadding. **First coating** hot bonded polyester foam, velvet adhesion in polyester and/or 100% polyester wool, 200gr. **Container bottom panels** 12-14 mm in poplar wood particles class E1.

### Caractéristiques techniques

**Tige** en pin et/ou boîtiers en multicouche en bois de peuplier. **Panneaux** de 18/25 mm en particules de bois de peuplier classe E1 à faible émission de formaldéhyde et fibre de bois naturelle. **Polyuréthane expansé** densité de 18kg/m<sup>2</sup> à 40kg/m<sup>2</sup>. **Coussin** rembourrés avec de la ouate de 300g. **Premier revêtement** en polyester expansé accouplé à chaud à un velours accrochant en polyester et/ou ouate de polyester à 100% de 200g. **Panneaux de fond coffre rangement** de 12-14mm en particules de bois de peuplier classe E1.

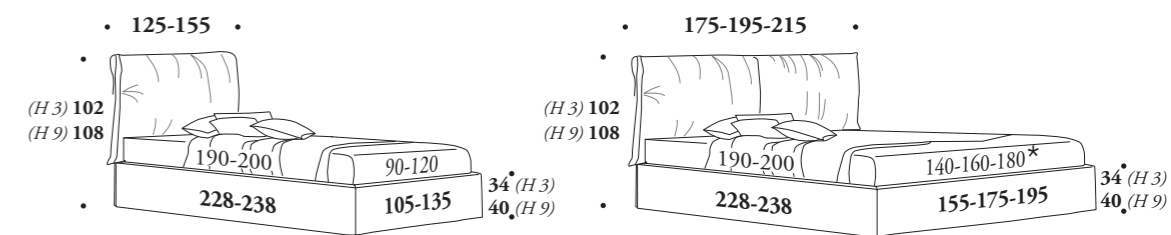

### Ring Eko



### Ring Liberty



### Standard

Basic  
H 3 cm



### Varianti colore / Color variants / Couleurs disponibles



Lux  
H 3 cm



Optional  
Visual  
H 9 cm



### Optional

Accessori  
Accessoires

Panquette  
Panquette



p. 370

Pouf con  
contenitore  
Pouf with  
container  
Pouf avec  
rangement



p. 388

Sacca  
portaoggetti  
Storage bag  
Sac porte-objets



p. 375

Meccanica / Mechanism / Mécanique p. 382



186

Rete / Support / Sommier p. 380

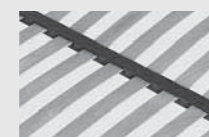

Armony



Thai  
46 doghe / slats / lattes

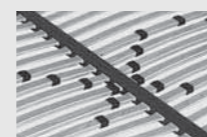

Energy

Non applicabile a rete da 120 cm  
Not applicable to 120 cm support  
Non applicable au sommier de 120 cm

Tessuto coprirete  
traspirante antipolvere  
Support cover fabric  
breathable and dustproof  
Tissu couvre-sommier  
transpirant anti-poussière

p. 384



Sacco contenitore  
Multipurpose  
storage bag  
Sac coffre de  
rangement multi  
usage

p. 385



p. 386

Regolatore  
altezza rete  
Support height  
adjuster  
Réglage  
hauteur  
sommier

p. 387

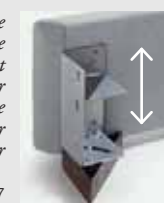

187

# D Patrick







# Patrick

- Relax System -

**Relax System** Grazie all'innovativa soluzione dei cuscini reclinabili molte testiere sono relax system, consentono cioè una comoda posizione "seduta" e un pratico appoggio di sostegno per leggere, guardare la tv, lavorare al laptop.

**Cuscini molto voluminosi e morbidi, indipendenti.** La parte superiore che ricorda il classico "Chesterfield" è evidenziata dall'elegante cordoncino sul profilo laterale, che enfatizza ancor di più la particolare finitura del tessuto proposto.



**Relax System** With the innovative solution of the headboard cushions, many headboards become relaxation systems, that is, allow a comfortable position while "sitting" and a practical support for reading, watching TV, working on laptop.

**The pillows are very voluminous and soft, independent.** The top part, reminiscent of the classic "Chesterfield", is highlighted by the elegant cord on the side profile, which emphasizes the particular finish of the fabric even more.

**Relax System** Grâce à la solution innovante des coussins tête de lit inclinable, de nombreuses tête de lits sont «relax system», elles permettent d'avoir une position assise commode et un appui pratique pour lire, regarder la télé, travailler avec l'ordinateur portable.

**Des coussins volumineux et moelleux, indépendants.** La partie supérieure, qui fait penser au classique "Chesterfield", est mise en évidence par l'élégance du cordon sur le profil latéral, qui souligne encore plus la finition du tissu.

- Relax System -





**Nb:** la finitura in foto è disponibile solo nelle varianti colore del tessuto SAFY nella trapuntatura a rombi o a quadri (categoria Deluxe).

## Patrick

Completamente sfoderabile  
Totally removable cover  
Complètement déhoussable

\*  
Rete L. 180 cm  
solo profondità 200 cm  
Support W. 180 cm  
only D 200 cm  
Sommier L. 180 cm  
uniquement en  
profondeur 200 cm

**Caratteristiche tecniche**  
**Masselli** in legno di abete e/o sciolati in multistrato di legno di pioppo. **Pannelli** da 18/25 mm in particelle di legno di pioppo in classe E1 a bassa emissione di formaldeide e fibra di legno naturale. **Espansi** di poliuretano indeformabile a portanza differenziata, densità da 18 kg/mc a 40 kg/mc.  
**Primo rivestimento** in espanso di poliestere accoppiato a caldo a vellutino aggrappante in poliestere e/o ovatta di poliestere al 100% da 200gr. **Pannelli fondo** contenitore da 12-14 mm in particelle di legno di pioppo in classe E1.

**Technical characteristics**  
**Forgings** fir wood, and/or boxed in poplar plywood. **Panels** 18/25 mm in poplar wood particles class E1 low formaldehyde emission and natural wood fiber. **Polyurethane foam**, crushproof, of different capacity, density from 18 kg/mc to 40 kg/mc.  
**First coating** hot bonded polyester foam, velvet adhesion in polyester and/or 100% polyester wool, 200gr. **Container bottom panels** 12-14 mm in poplar wood particles class E1.

**Caractéristiques techniques**  
**Tige** en pin et/ou boitiers en multicouche en bois de peuplier. **Panneaux** de 18/25 mm en particules de bois de peuplier classe E1 à faible émission de formaldéhyde et fibre de bois naturelle. **Polyuréthane expansé** indéformable à portée différenciée. densité de 18kg/m² à 40kg/m².  
**Premier revêtement** en polyester expansé accouplé à chaud à un velours accrochant en polyester et/ou ouate de polyester à 100% de 200g. **Panneaux de fond coffre rangement** de 12-14mm en particules de bois de peuplier classe E1.

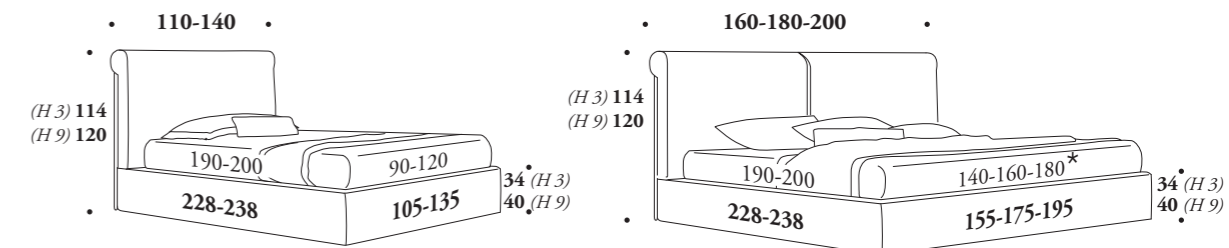

## Ring Eko



Standard  
Basic  
H 3 cm

wengé  
wengé  
wengé

Varianti colore / Color variants / Couleurs disponibles

nero  
black  
noir

bianco  
white  
blanc

argento  
silver  
argent

Lux  
H 3 cm

wengé  
wengé  
wengé

nero  
black  
noir

bianco  
white  
blanc

cromo  
chrome  
chrome

Optional

Visual  
H 9 cm

wengé  
wengé  
wengé

nero  
black  
noir

bianco  
white  
blanc

argento  
silver  
argent

Note: the finish in the picture is available in the colors of the SAFY fabric, with a lozenge or square finish (Deluxe category).

Nb: la finition de la photo est disponible en plusieurs couleurs de tissu SAFY finition avec losanges ou avec carrés (catégorie Deluxe).



Portagioie p. 376  
Jewelry Box - Porte-bijoux



Porta USB p. 377  
USB holder - Port USB



Meccanica / Mechanism / Mécanique p. 382



194

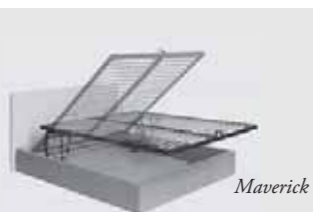

Maverick

Rete / Support / Sommier p. 380



Armony

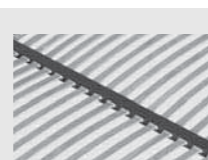

Thai  
46 doghe / slats / lattes

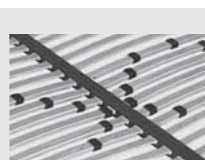

Energy  
Non applicabile a rete da 120 cm  
Not applicable to 120 cm support  
Non applicable au sommier de 120 cm

Tessuto coprirete  
traspirante antipolvere  
Support cover fabric  
breathable and dustproof  
Tissu couvre-sommier  
transpirant anti-poussière

p. 384

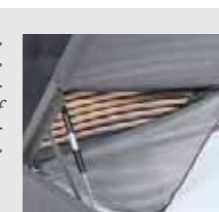

Sacco contenitore  
Multiuso  
Multipurpose  
storage bag  
Sac coffre de  
rangement multi  
usage

p. 385



Clean Up System  
+13 cm

p. 386

Regolatore  
altezza rete  
Support height  
adjuster  
Réglage  
hauteur  
sommier

p. 387



195

Optional  
Accessori  
Accessoires



p. 370



p. 368



p. 375

# Jerry





Jerry





*La testiera come una vera cornice contiene un pannello che può essere a contrasto o coordinato al resto del letto.*

*The headboard, like a frame, contains a panel that can be in contrast or matching with the rest of the bed.*

*La tête de lit est un vrai cadre qui contient un panneau qui peut être en contraste ou assorti au reste du lit.*

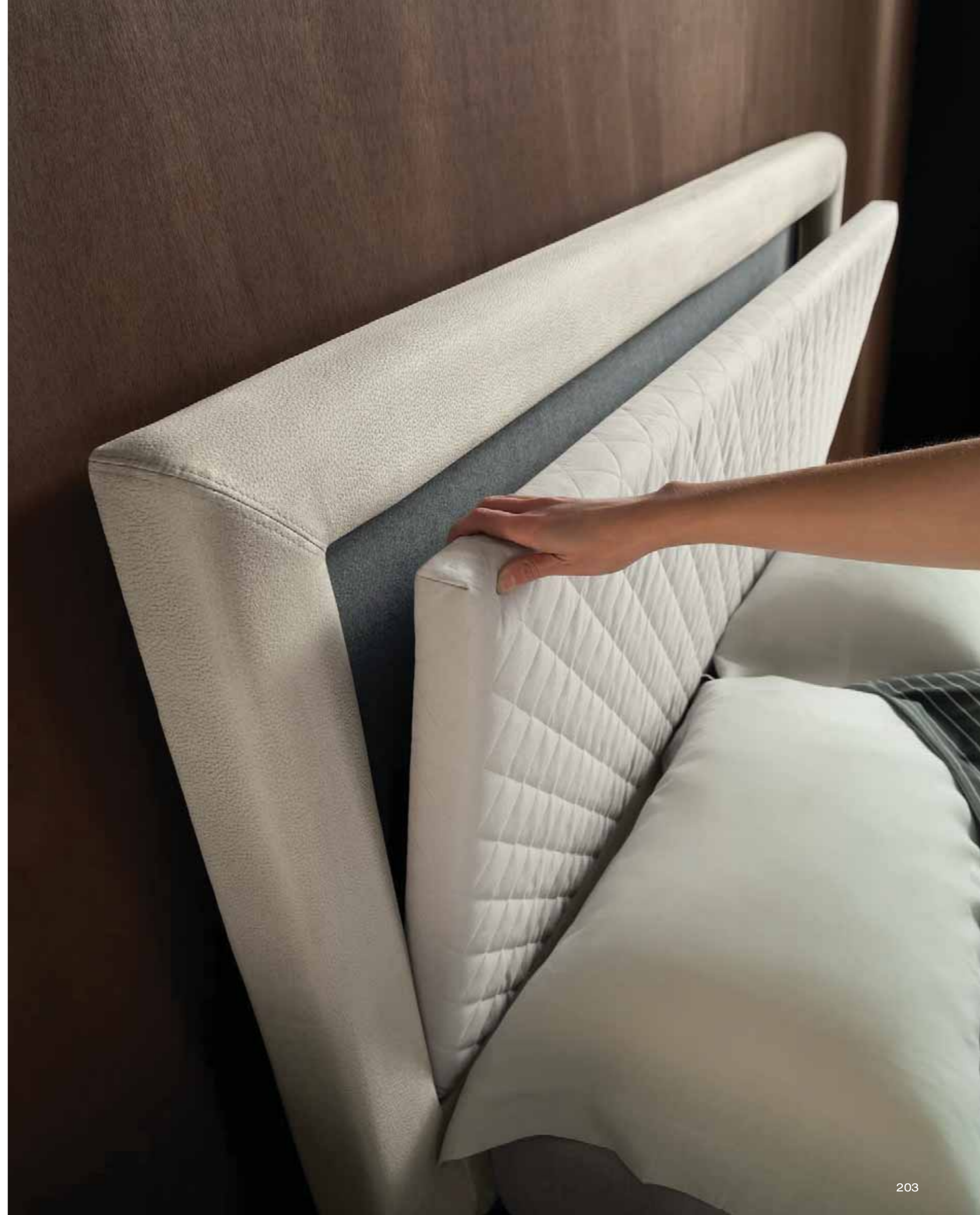



*La finitura trapuntata a rombi o a quadri (categoria Deluxe) è disponibile solo nella scelta colori del tessuto SAFY.*



*The lozenge or square quilted finishing (Deluxe category) is available only in the colors of the SAFY fabric.*

*La finition matelassée à losanges ou à carrés (catégorie Deluxe) est disponible uniquement pour les couleurs de tissu SAFY.*

## Jerry

Completamente sfoderabile  
Totally removable cover  
Complètement déhoussable

### Caratteristiche tecniche

**Masselli** in legno di abete e/o scatolati in multistrato di legno di pioppo. **Pannelli** da 18/25 mm in particelle di legno di pioppo in classe E1 a bassa emissione di formaldeide e fibra di legno naturale. **Espansi** di poliuretano indeformabile a portanza differenziata, densità da 18 kg/mc a 40 kg/mc.

**Primo rivestimento** in espanso di poliestere accoppiato a caldo a vellutino aggrappante in poliestere e/o ovatta di poliestere al 100% da 200gr. **Pannelli fondo** contenitore da 12-14 mm in particelle di legno di pioppo in classe E1.

### Technical characteristics

**Forgings** fir wood, and/or boxed in poplar plywood. **Panels** 18/25 mm in poplar wood particles class E1 low formaldehyde emission and natural wood fiber.

**Polyurethane foam**, crushproof, of different capacity, density from 18 kg/mc to 40 kg/mc.

**First coating** hot bonded polyester foam, velvet adhesion in polyester and/or 100% polyester wool, 200gr. **Container bottom panels** 12-14 mm in poplar wood particles class E1.

### Caractéristiques techniques

**Tige** en pin et/ou boitiers en multicouche en bois de peuplier.

**Panneaux** de 18/25 mm en particules de bois de peuplier classe E1 à faible émission de formaldéhyde et fibre de bois naturelle. **Polyuréthane expansé** indéformable à portée différenciée, densité de 18kg/m<sup>2</sup> à 40kg/m<sup>2</sup>.

**Premier revêtement** en polyester expansé accouplé à chaud à un velours accrochant en polyester et/ou ouate de polyester à 100% de 200g.

**Panneaux de fond coffre rangement** de 12-14mm en particules de bois de peuplier classe E1.

\*  
Rete L. 180 cm  
solo profondità 200 cm  
Support W. 180 cm  
only D 200 cm  
Sommier L. 180 cm  
uniquement en  
profondeur 200 cm

## Ring Smart



Standard  
Basic  
H 3 cm



Varianti colore / Color variants / Couleurs disponibles



Optional

Lux  
H 3 cm



Visual  
H 9 cm

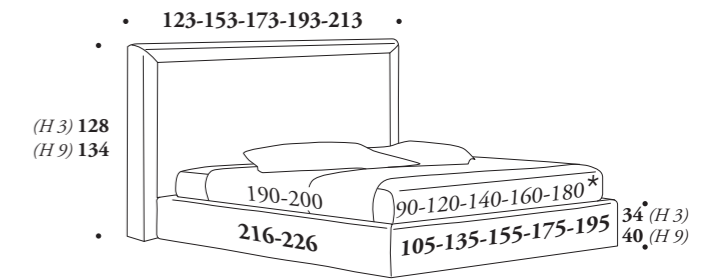

## Ring York



Standard  
Ghost  
H 13 cm



Senza possibilità di contenitore solo con rete fissa  
Without the possibility of container only with fixed support  
Sans possibilité de coffre de rangement uniquement pour sommier fixe

Optional

Blade  
H 13 cm

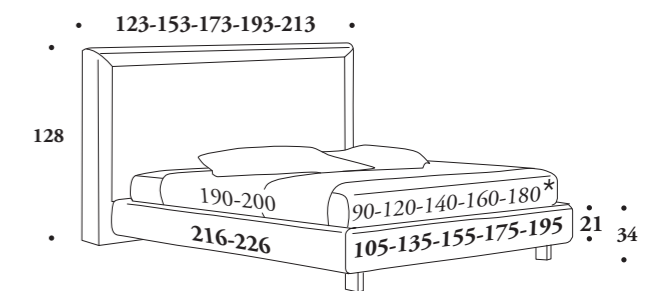

Optional  
Accessori  
Accessoires

Panquette  
Panquette  
Panquette



p. 370

Pouf con  
contenitore  
Pouf with  
container  
Pouf avec  
rangement



p. 368

Sacca  
portaoggetti  
Storage bag  
Sac porte-objets



p. 375

Meccanica / Mechanism / Mécanique p. 382

Rete / Support / Sommier p. 380



Dynamic

204



Maverick

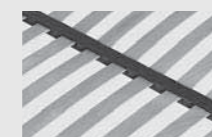

Armony



Thai  
46 doghe / slats / lattes

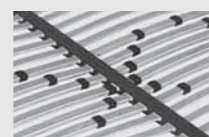

Energy

Non applicabile a rete da 120 cm  
Not applicable to 120 cm support  
Non applicable au sommier de 120 cm

Tessuto coprirete  
traspirante antipolvere  
Support cover fabric  
breathable and dustproof  
Tissu couvre-sommier  
transpirant anti-poussière

p. 384

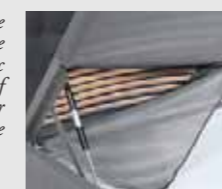

Sacco contenitore  
multiuso  
Multipurpose  
storage bag  
Sac coffre de  
rangement multi  
usage

p. 385

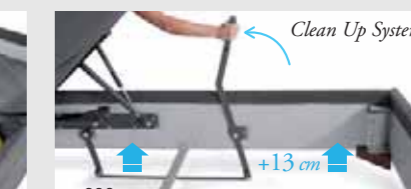

p. 386

Regolatore  
altezza rete  
Support height  
adjuster  
Réglage  
hauteur  
sommier

p. 387



205



# Night *of* nights

*A complete bedroom collection by Felis*

*Benedetto sia colui che inventò il sonno, cappa che copre tutti gli umani pensieri, cibo che toglie la fame, acqua che estingue la sete, fuoco per cui fugge il freddo, freddo che temprava l'ardore, moneta generale con cui tutto si compra, bilancia e peso che rende eguale il re al pastore e il saggio allo zotico.*

*Miguel de Cervantes, Don Chisciotte della Mancia, 1605/15*

*Now, blessings light on him that first invented sleep! It covers a man all over, thoughts and all, like a cloak; it is meat for the hungry, drink for the thirsty, heat for the cold, and cold for the hot. It is the current coin that purchases all the pleasures of the world cheap, and the balance that sets the king and the shepherd, the fool and the wise man, even.*

*Miguel de Cervantes, Don Chisciotte della Mancia, 1605/15*

*Béni soit celui qui inventa le sommeil, manteau qui recouvre toutes les pensées humaines, mets qui ôtes la faim, eau qui chasse la soif, feu qui réchauffe la froidure, fraîcheur qui tempère la chaleur brûlante, monnaie universelle, avec laquelle s'achète toute chose, et balance où s'égalisent le pâtre et le roi, le simple et le sage.*

*Miguel de Cervantes, Don Quixote de la Mancha, 1605/15*

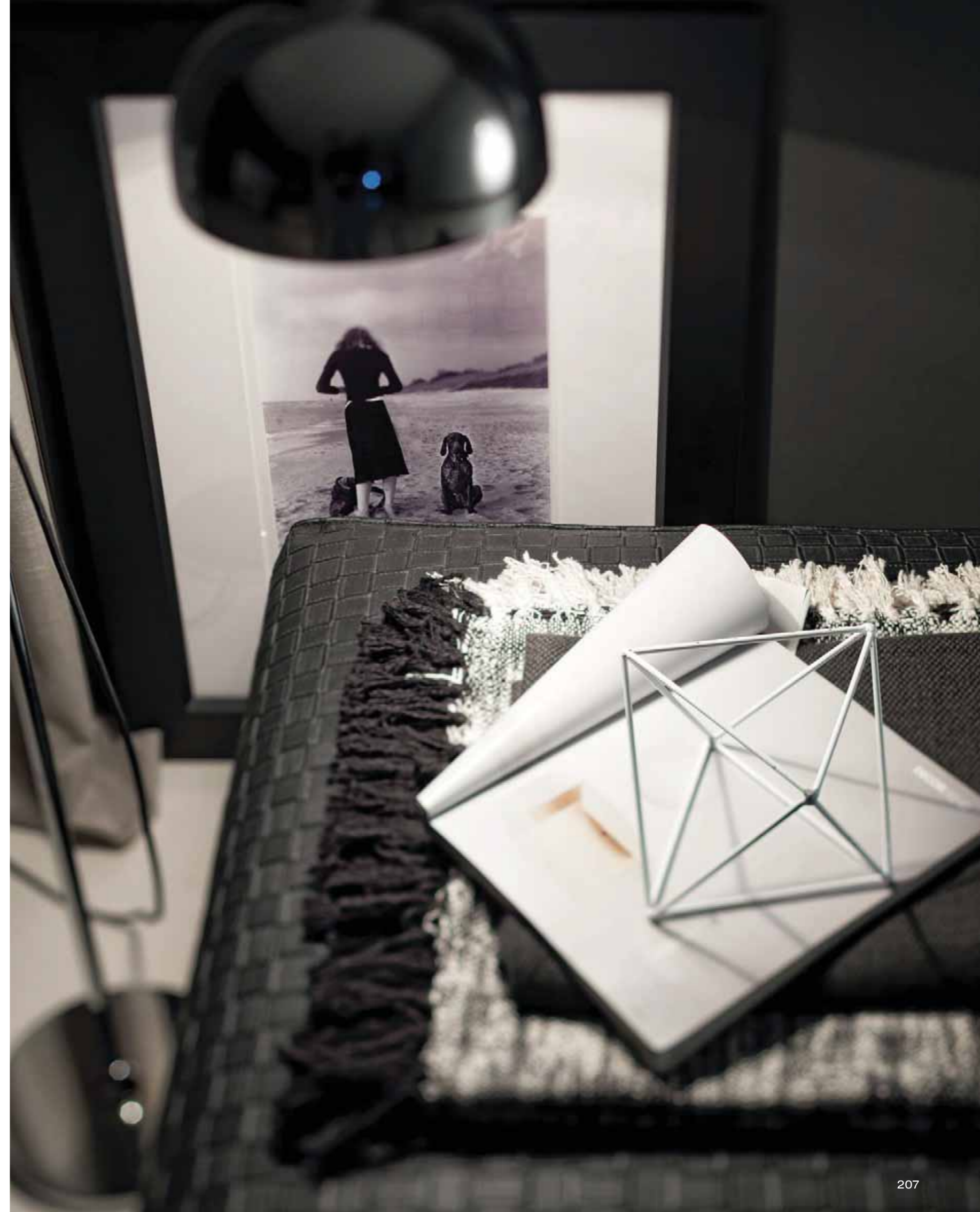

# D

## Damian





# Damian



***Il comodo grande pouf  
coordinato** nel rivestimento e  
nella finitura del letto  
da posizionare alla pediera.  
Un piano di seduta...  
Un piano di appoggio  
disponibile con o senza  
contenitore...*

***The comfortable and big  
ottoman,** coordinated in the  
cover and finishing of the bed to  
be placed at the footboard.  
A seat...  
A support surface available  
with or without container...*

***Le grand pouf pratique  
assorti** au revêtement et  
à la finition du lit à placer  
au pied du lit.  
Une surface pour s'asseoir...  
Un plan d'appui disponible  
avec ou sans rangement.*





# Damian

***Un profilo classico per Damian...***

*Nelle curve della testiera, nel ring arrotondato.*

*Moderno il gioco dei colori tra il bianco, l'argento e l'écru.*

*Infine ad impreziosire Damian il sottile bordo a contrasto su angoli e testiera.*

***A classic profile for Damian...***

*In the curves of the headboard in the rounded ring.*

*Modern play of colors between white, silver and écru. Finally Damian is embellished by the subtle contrasting edge on corners and headboard.*

***Un profil classique pour Damian...***

*Dans les courbes de la tête de lit dans le tour de lit arrondi. Le jeu moderne des couleurs entre le blanc, l'argent et l'écru. Et pour rendre Damian encore plus précieux, le bord fin en contraste sur les angles et la tête de lit.*





*Comunque elegante  
nella versione alta con gonnella  
a volant, così come nella  
versione svasata verso l'esterno,  
sollevata da un piedino  
importante e impreziosita da  
cordoncino a contrasto.*



*However elegant  
in the high version with skirt  
with frills. Like in the version  
flared outward and raised by  
important feet and embellished  
with contrasting cord.*

*Toujours élégante  
dans la version haute avec  
jupe à volant. Comme dans la  
version évasée vers l'extérieur et  
soulevée par un pied important  
et un cordon en contraste qui la  
rend plus précieuse.*

## Damian

Completamente sfoderabile  
Totally removable cover  
Complètement déhoussable

\*  
Rete L. 180 cm  
solo profondità 200 cm  
Support W. 180 cm  
only D 200 cm  
Sommier L. 180 cm  
uniquement en  
profondeur 200 cm

### Caratteristiche tecniche

**Masselli** in legno di abete e/o scatolati in multistrato di legno di pioppo. **Pannelli** da 18/25 mm in particelle di legno di pioppo in classe E1 a bassa emissione di formaldeide e fibra di legno naturale. **Espansi** di poliuretano indeformabile a portanza differenziata, densità da 18 kg/mc a 40 kg/mc.

**Primo rivestimento** in espanso di poliestere accoppiato a caldo a vellutino aggrappante in poliestere e/o ovatta di poliestere al 100% da 200gr. **Pannelli fondo** contenitore da 12-14 mm in particelle di legno di pioppo in classe E1.

### Technical characteristics

**Forgings** fir wood, and/or boxed in poplar plywood. **Panels** 18/25 mm in poplar wood particles class E1 low formaldehyde emission and natural wood fiber.

**Polyurethane foam**, crushproof, of different capacity, density from 18 kg/mc to 40 kg/mc.

**First coating** hot bonded polyester foam, velvet adhesion in polyester and/or 100% polyester wool, 200gr. **Container bottom panels** 12-14 mm in poplar wood particles class E1.

### Caractéristiques techniques

**Tige** en pin et/ou boitiers en multicouche en bois de peuplier.

**Panneaux** de 18/25 mm en particules de bois de peuplier classe E1 à faible émission de formaldéhyde et fibre de bois naturelle. **Polyuréthane expansé** indéformable à portée différenciée, densité de 18kg/m<sup>2</sup> à 40kg/m<sup>2</sup>.

**Premier revêtement** en polyester expansé accouplé à chaud à un velours accrochant en polyester et/ou ouate de polyester à 100% de 200g. **Panneaux de fond coffre rangement** de 12-14mm en particules de bois de peuplier classe E1.

Tessuto coprirete  
traspirante antipolvere  
Support cover fabric  
breathable and dustproof  
Tissu couvre-sommier  
transpirant anti-poussière

p. 384

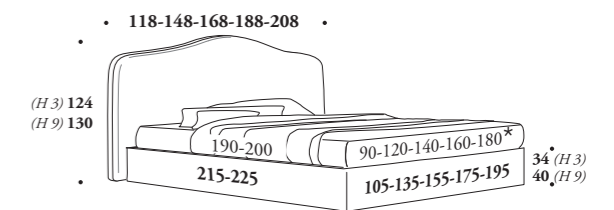

## Ring Smart



### Standard

Basic  
H 3 cm

wengé  
wengé  
wengé



## Ring Venice



### Varianti colore / Color variants / Couleurs disponibles

nero  
black  
noir

bianco  
white  
blanc

argento  
silver  
argent



Lux  
H 3 cm

wengé  
wengé  
wengé



nero  
black  
noir

bianco  
white  
blanc

cromo  
chrome  
chrome



Optional  
Visual  
H 9 cm

wengé  
wengé  
wengé



nero  
black  
noir

bianco  
white  
blanc

argento  
silver  
argent



## Ring Chic



Standard  
Mozart  
H 13 cm

wengé / wengé / wengé



118-148-168-188-208

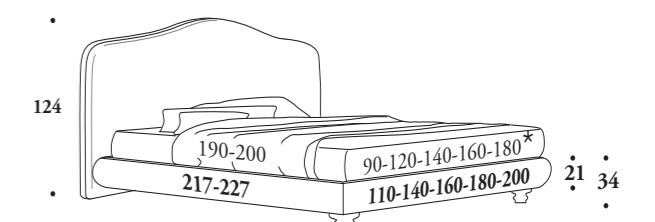

### Varianti colore / Color variants / Couleurs disponibles

bianco / white / blanc

argento / silver / argent

oro / gold / or



### Optional

Accessori  
Accessories  
Accessoires

Panquette  
contentitore  
Panquette

p. 370



Pouf con  
contentore  
Pouf with  
container  
Pouf avec  
rangement

p. 368



Sacca  
portaoggetti  
Storage bag  
Sac porte-objets

p. 375



Meccanica / Mechanism / Mécanique p. 382

Rete / Support / Sommier p. 380



218

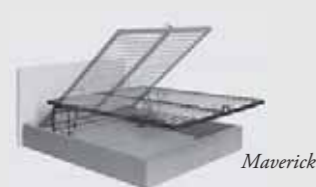

Maverick



Armony

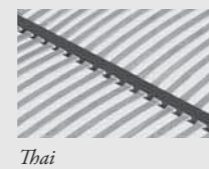

Thai  
46 doghe / slats / lattes

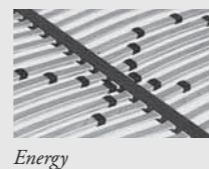

Energy  
Non applicabile a rete da 120 cm  
Not applicable to 120 cm support  
Non applicable au sommier de 120 cm

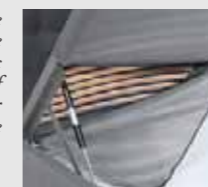

Sacco contenitore  
multiuso  
Multipurpose  
storage bag  
Sac coffre de  
rangement multi  
usage

p. 385



p. 386

Regolatore  
altezza rete  
Support height  
adjuster  
Réglage  
hauteur  
sommier

p. 387



219

# Night of nights

*A complete bedroom collection by Felis*

*Una volta, Zhuang Zhou sognò di essere una farfalla. Era una farfalla che volteggiava liberamente, appagata della propria condizione. Non sapeva di essere Zhou. All'improvviso si svegliò e si accorse di essere Zhou, con la sua forma. Non poteva dire se Zhou avesse sognato di essere una farfalla, o se una farfalla stesse sognando di essere Zhou.*

*Chuang-tzu, IV sec. a.C*

*Once, Zhuang Zhou dreamed he was a butterfly. It was a butterfly hovering freely, satisfied by its condition. She did not know she was Zhou. Suddenly she woke up and realized she was Zhou, with his shape. She could not say whether Zhou had dreamed of being a butterfly, or a butterfly was dreaming of being Zhou.*

*Chuang-tzu, IV cent. B.C.*

*Un jour, Zhuang Zhou, rêva qu'il était un papillon. C'était un papillon qui voletait librement, heureux de sa condition. Il ne savait pas qu'il était Zhou. Soudain il se réveilla et il se rendit compte qu'il était Zhou, avec sa forme. Il ne pouvait pas dire si Zhou avait rêvé d'être un papillon, ou si un papillon avait rêvé d'être Zhou.*

*Chuang-tzu, IV siècle av.J.C.*





# Karl





Karl





*Il tono squadrato e monocromo del design è ripreso dall'effetto capitonné "giocato" con l'ironia dei colori pastello dei bottoni.*

*The squared and monochrome tone of the design is reprised by the quilted effect "played" with the irony of the pastel colors of the buttons.*

*Le côté carré et monochrome du design est repris par l'effet capitonné "qui joue" avec l'ironie des couleurs pastel des boutons.*

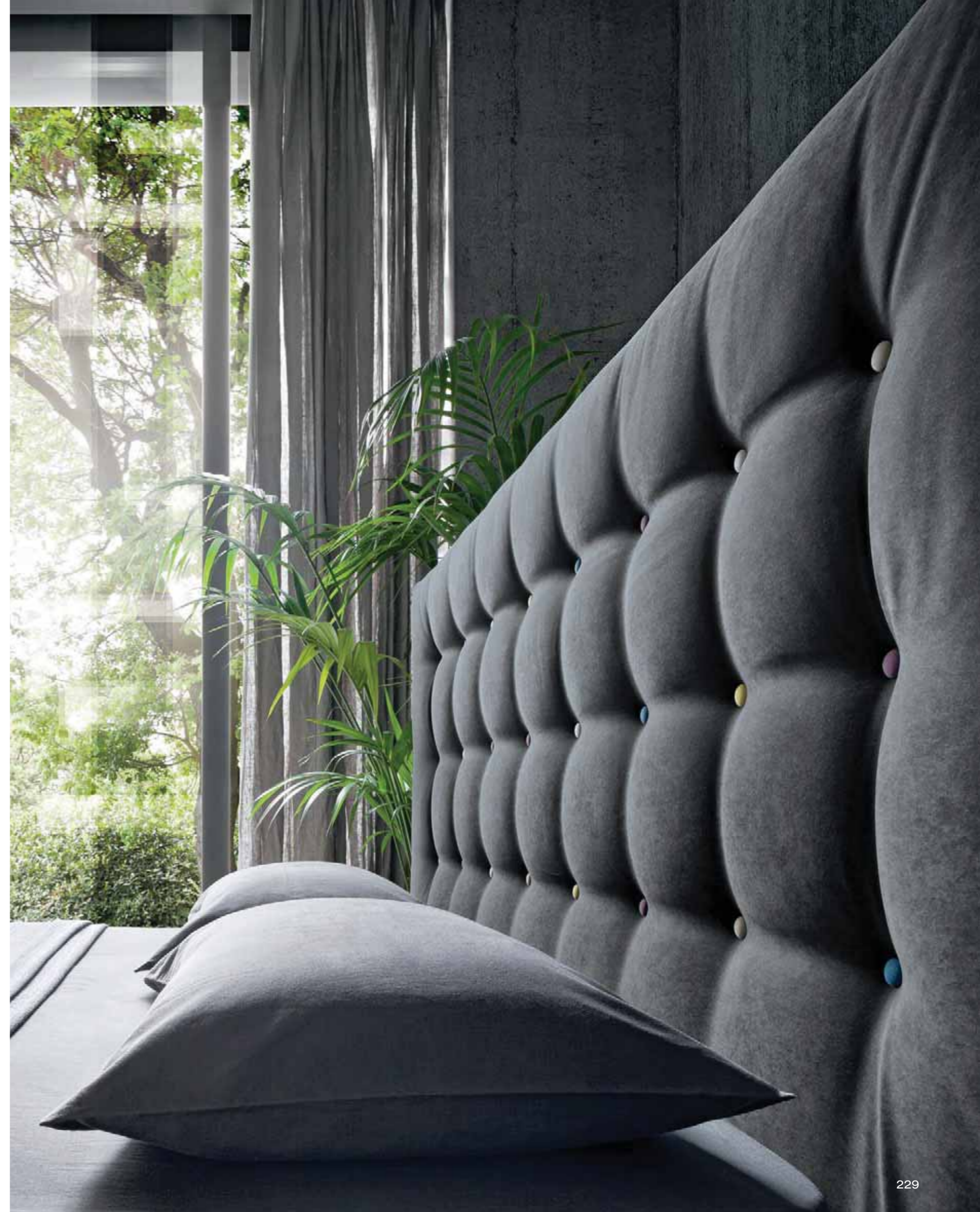



*I bottoni possono essere in tinta unita come il tessuto o a contrasto, multicolor (n.b. predefinito azienda), o Swarovski bianco o nero.*

*Buttons can be in the same color as the fabric or in contrast, or multicolor (company-defined), or white or black Swarovski.*

*Les boutons peuvent être de couleur unie, de la même couleur du tissu, ou en contraste, ou encore multicolor (nb. défini par le fabricant), ou Swarovski blanc ou noir.*

## Karl

Completamente sfoderabile  
Totally removable cover  
Complètement déhoussable

### Caratteristiche tecniche

**Masselli** in legno di abete e/o scatolati in multistrato di legno di pioppo. **Pannelli** da 18/25 mm in particelle di legno di pioppo in classe E1 a bassa emissione di formaldeide e fibra di legno naturale. **Espansi** di poliuretano indeformabile a portanza differenziata, densità da 18 kg/mc a 40 kg/mc.

**Primo rivestimento** in espanso di poliestere accoppiato a caldo a vellutino aggrappante in poliestere e/o ovatta di poliestere al 100% da 200gr. **Pannelli fondo** contenitore da 12-14 mm in particelle di legno di pioppo in classe E1.

### Technical characteristics

**Forgings** fir wood, and/or boxed in poplar plywood. **Panels** 18/25 mm in poplar wood particles class E1 low formaldehyde emission and natural wood fiber. **Polyurethane foam**, crushproof, of different capacity, density from 18 kg/mc to 40 kg/mc.

**First coating** hot bonded polyester foam, velvet adhesion in polyester and/or 100% polyester wool, 200gr. **Container bottom panels** 12-14 mm in poplar wood particles class E1.

### Caractéristiques techniques

**Tige** en pin et/ou boitiers en multicouche en bois de peuplier.

**Panneaux** de 18/25 mm en particules de bois de peuplier classe E1 à faible émission de formaldéhyde et fibre de bois naturelle. **Polyuréthane expansé** indéformable à portée différenciée. densité de 18kg/m<sup>2</sup> à 40kg/m<sup>2</sup>.

**Premier revêtement** en polyester expansé accouplé à chaud à un velours accrochant en polyester et/ou ouate de polyester à 100% de 200g.

**Panneaux de fond coffre rangement** de 12-14mm en particules de bois de peuplier classe E1.

\*  
Rete L. 180 cm  
solo profondità 200 cm  
Support W. 180 cm  
only D 200 cm  
Sommier L. 180 cm  
uniquement en  
profondeur 200 cm

## Ring Smart



### Standard

#### Basic

H 3 cm



wengé  
wengé  
wengé

### Varianti colore / Color variants / Couleurs disponibles



nero  
black  
noir



bianco  
white  
blanc



argento  
silver  
argent

### Lux

H 3 cm



wengé  
wengé  
wengé



nero  
black  
noir



bianco  
white  
blanc



cromo  
chrome  
chrome

Optional

### Visual

H 9 cm



wengé  
wengé  
wengé



nero  
black  
noir



bianco  
white  
blanc



argento  
silver  
argent



*Bottoni in tinta unita come il tessuto o a contrasto oppure multicolor (predefinito azienda) o Swarovski bianco o nero.  
Buttons in the same color as the fabric, or contrasting, or mixed colors (defined by the company) or black or white Swarovski.  
Boutons couleur tissu ou en contraste ou mélange de couleur (définis par le fabricant) ou Swarovski blanc ou noir.*

## Optional

Accessori  
Accessoires

Panquette  
Panquette  
Panquette



p. 370

Pouf con  
contenitore  
Pouf with  
container  
Pouf avec  
rangement



p. 368

Sacca  
portaoggetti  
Storage bag  
Sac porte-objets



p. 375

Meccanica / Mechanism / Mécanique p. 382

Rete / Support / Sommier p. 380



Dynamic

230

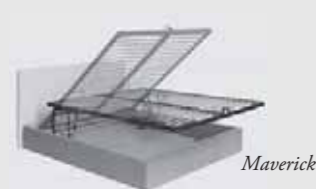

Maverick



Armony

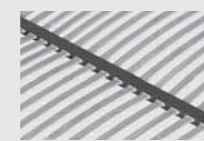

Thai  
46 doghe / slats / lattes

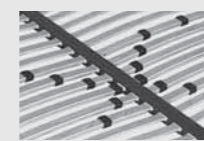

Energy

Non applicabile a rete da 120 cm  
Not applicable to 120 cm support  
Non applicable au sommier de 120 cm

Tessuto coprirete  
traspirante antipolvere  
Support cover fabric  
breathable and dustproof  
Tissu couvre-sommier  
transpirant anti-poussière

p. 384

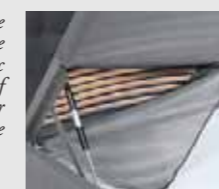

Sacco contenitore  
Multiuso  
Multipurpose  
storage bag  
Sac coffre de  
rangement multi  
usage

p. 385

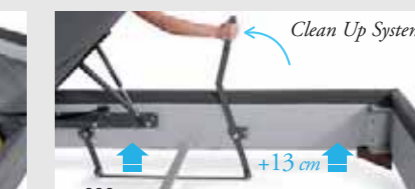

p. 386

Regolatore  
altezza rete  
Support height  
adjuster  
Réglage  
hauteur  
sommier

p. 387



231

Luis







**Relax System**

*Grazie all'innovativa soluzione dei cuscini reclinabili le testiere sono relax system, consentono cioè una comoda posizione "seduta" e un pratico appoggio di sostegno per leggere, guardare la tv, lavorare al laptop...*

**Relax System**

*With the innovative solution of the headboard cushions, many headboards become relaxation systems, that is, allow a comfortable position while "sitting" and a practical support for reading, watching TV, working on laptop...*

**Relax System**

*Grâce à la solution innovante des coussins tête de lit inclinable, de nombreuses tête de lits sont « relax system », elles permettent d'avoir une position assise commode et un appui pratique pour lire, regarder la télé, travailler avec l'ordinateur portable...*







**L'eleganza della semplicità.**  
 Il cordoncino in colore a contrasto sui bordi dei grandi cuscini della testiera e sugli angoli di giunzione al piede del giroletto.

**The elegance of simplicity.**  
 The cord with a contrasting color on the edges of the big pillows on the headboard and on the corners at the foot of the bed frame.

**L'élégance de la simplicité.**  
 Le cordon de couleur contrastée sur les bords des grands coussins de la tête de lit et sur les angles de jonction au pied du tour de lit.



Portagioie  
 Jewelry Box  
 Porte-bijoux

p. 376



Porta USB  
 USB holder  
 Port USB

p. 377

## Luis

Completamente sfoderabile  
 Totally removable cover  
 Complètement déhoussable

\*  
 Rete L. 180 cm  
 solo profondità 200 cm  
 Support W. 180 cm  
 only D 200 cm  
 Sommier L. 180 cm  
 uniquement en  
 profondeur 200 cm

### Caratteristiche tecniche

**Masselli** in legno di abete e/o scatolati in multistrato di legno di pioppo. **Pannelli** da 18/25 mm in particelle di legno di pioppo in classe E1 a bassa emissione di formaldeide e fibra di legno naturale. **Espansi** di poliuretano in densità da 18 kg/mc a 40 kg/mc. **Cuscini** rivestiti in ovatta da 300 gr. **Primo rivestimento** in espanso di poliestere accoppiato a caldo a vellutino aggrappante in poliestere e/o ovatta di poliestere al 100% da 200gr. **Pannelli fondo** contenitore da 12-14 mm in particelle di legno di pioppo in classe E1.

### Technical characteristics

**Forgings** fir wood, and/or boxed in poplar plywood. **Panels** 18/25 mm in poplar wood particles class E1 low formaldehyde emission and natural wood fiber. **Polyurethane foam** density from 18 kg/mc to 40 kg/mc. **Cushions** coated with 300 gr wadding. **First coating** hot bonded polyester foam, velvet adhesion in polyester and/or 100% polyester wool, 200gr. **Container bottom panels** 12-14 mm in poplar wood particles class E1.

### Caractéristiques techniques

**Tige** en pin et/ou boitiers en multicouche en bois de peuplier. **Panneaux** de 18/25 mm en particules de bois de peuplier classe E1 à faible émission de formaldéhyde et fibre de bois naturelle. **Polyuréthane expansé** densité de 18kg/m<sup>2</sup> à 40kg/m<sup>2</sup>. **Coussin** rembourrés avec de la ouate de 300g. **Premier revêtement** en polyester expansé accouplé à chaud à un velours accrochant en polyester et/ou ouate de polyester à 100% de 200g. **Panneaux de fond coffre rangement** de 12-14mm en particules de bois de peuplier classe E1.

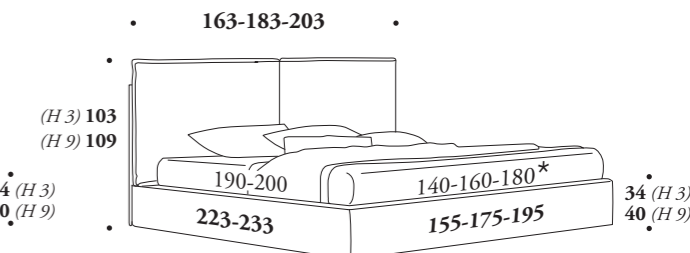
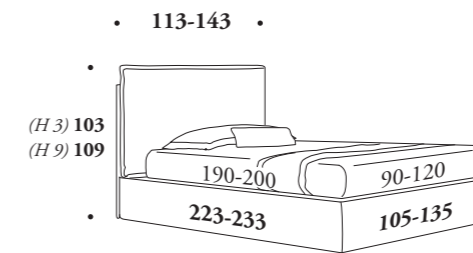

### Ring Eko



### Ring Liberty



### Standard

Basic  
 H 3 cm

wengé  
 wengé  
 wengé



### Varianti colore / Color variants / Couleurs disponibles

nero  
 black  
 noir



bianco  
 white  
 blanc



argento  
 silver  
 argent



### Lux

H 3 cm

wengé  
 wengé  
 wengé



### nero

black  
 noir



### bianco

white  
 blanc



### cromo

chrome  
 chrome



### Optional

Visual  
 H 9 cm

wengé  
 wengé  
 wengé



nero  
 black  
 noir



bianco  
 white  
 blanc



argento  
 silver  
 argent



### Optional

Accessori  
 Accessoires  
 Accessoires

Panquette  
 Panquette  
 Panquette



p. 370

Panquette con  
 contenitore  
 Panquette with  
 container  
 Panquette avec  
 rangement



p. 368

Sacca  
 portaoggetti  
 Storage bag  
 Sac porte-objets



p. 375

Meccanica / Mechanism / Mécanique p. 382



Dynamic

238

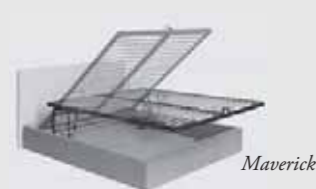

Maverick

Rete / Support / Sommier p. 380



Armony

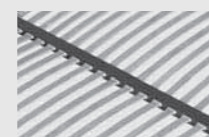

Thai  
 46 doghe / slats / lattes

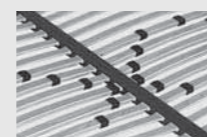

Energy

Non applicabile a rete da 120 cm  
 Not applicable to 120 cm support  
 Non applicable au sommier de 120 cm

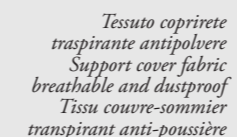

Tessuto coprirete  
 traspirante antipolvere  
 Support cover fabric  
 breathable and dustproof  
 Tissu couvre-sommier  
 respirant anti-poussière

p. 384

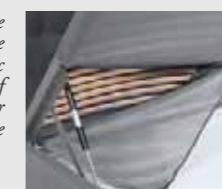

Sacco contenitore  
 Multipurpose  
 storage bag  
 Sac coffre de  
 rangement multi  
 usage

p. 385



p. 386

Regolatore  
 altezza rete  
 Support height  
 adjuster  
 Réglage  
 hauteur  
 sommier

p. 387

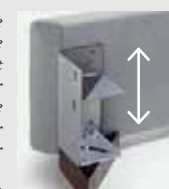

239

# Night *of* nights

*A complete bedroom collection by Felis*

*Anche la durata media dei cicli del sonno umano, circa 90 minuti, dipende dalla necessità di essere vigili di tanto in tanto durante la notte. «Il ciclo di sonno degli umani prevede un risveglio di 20-30 secondi ogni circa 90 minuti: quei secondi servivano ai nostri avi perché potessero guardarsi in giro, assicurarsi che tutti fossero al sicuro, e poi riaddormentarsi». Il bisogno di sicurezza ha una radice molto profonda: per questo costruire un ambiente sicuro e tranquillo intorno a sé è il modo migliore per prepararsi per dormire.*

*Even the average duration of human sleep cycles, about 90 minutes, depends on the need to be occasionally vigilant during the night. “The sleep cycle of humans involves an awakening of 20-30 seconds every 90 minutes: those seconds were used by our ancestors to look around and make sure everyone was safe, and then they went back to sleep.” The need for security has a very deep root: that is why building a safe and peaceful environment is the best way to prepare ourselves for sleep.*

*La durée moyenne des cycles de sommeil, d'environ 90 minutes, dépend d'un besoin de vigilance de temps en temps pendant la nuit. “Le cycle de sommeil des humains prévoit un réveil de 20-30 secondes chaque 90 minutes: ces secondes servaient à nos ancêtres pour contrôler les alentours et s'assurer que tout allait bien pour ensuite se rendormir”. Le besoin de sécurité a une racine plus profonde et construire un environnement sûr et tranquille autour de soi est la meilleure façon de se préparer à dormir.*

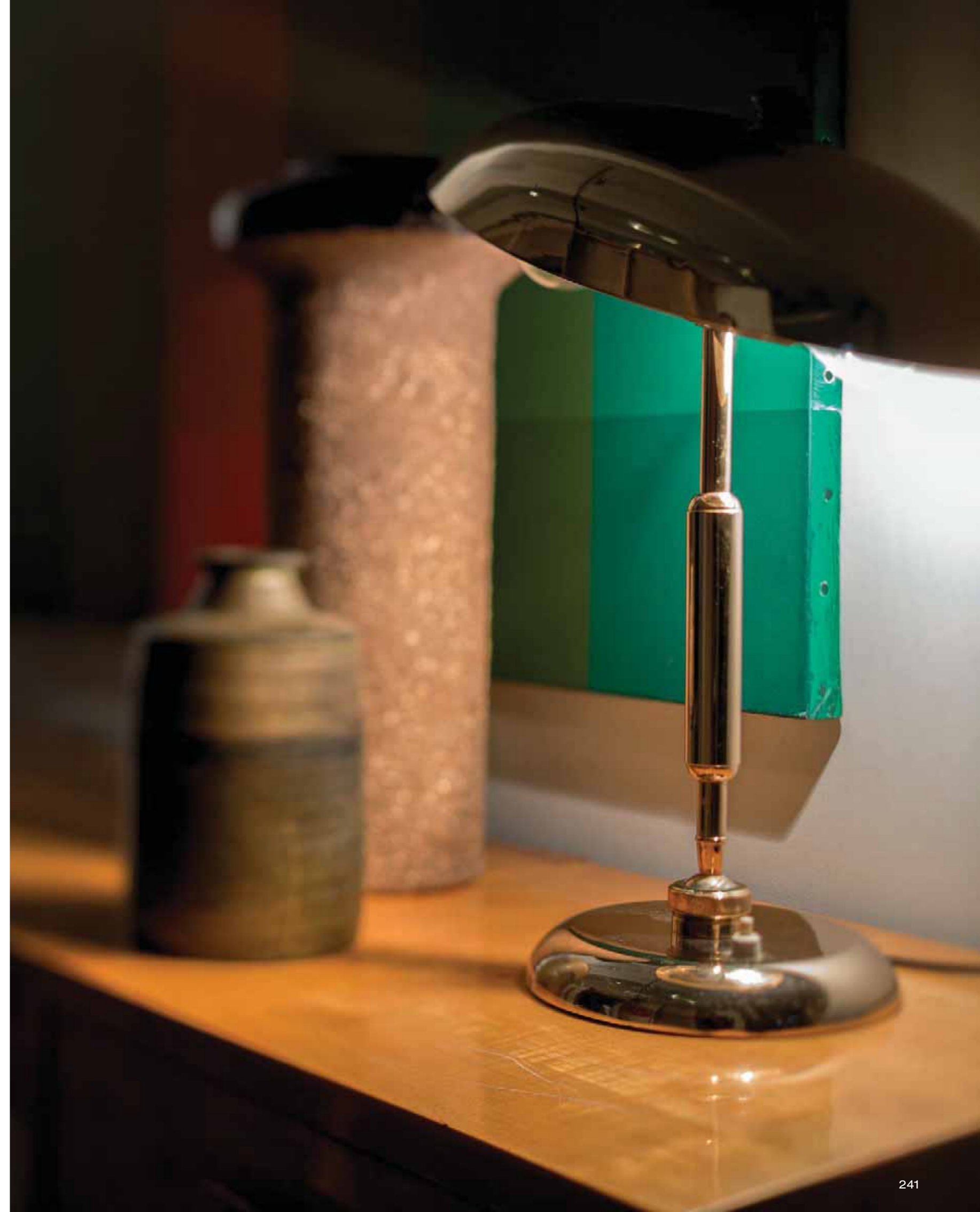

# G George





# George

- Relax System -



### **Relax System**

*Grazie all'innovativa soluzione dei cuscini reclinabili le testiere sono relax system, consentono cioè una comoda posizione "seduta" e un pratico appoggio di sostegno per leggere, guardare la tv, lavorare al laptop...*

### **Relax System**

*With the innovative solution of the headboard cushions, many headboards become relaxation systems, that is, allow a comfortable position while "sitting" and a practical support for reading, watching TV, working on laptop...*

### **Relax System**

*Grâce à la solution innovante des coussins tête de lit inclinable, de nombreuses tête de lits sont « relax system », elles permettent d'avoir une position assise commode et un appui pratique pour lire, regarder la télé, travailler avec l'ordinateur portable...*





*La cucitura con impatto estetico preciso e forte delinea i bordi dei cuscini e della struttura del letto ricreando un dettaglio stilistico e sartoriale giovane e contemporaneo.*

# George

Completamente sfoderabile  
Totally removable cover  
Complètement déhoussable

\*  
Rete L. 180 cm  
solo profondità 200 cm  
Support W. 180 cm  
only D 200 cm  
Sommier L. 180 cm  
uniquement en  
profondeur 200 cm

**Caratteristiche tecniche**  
**Masselli** in legno di abete e/o sciolati in multistrato di legno di pioppo. **Pannelli** da 18/25 mm in particelle di legno di pioppo in classe E1 a bassa emissione di formaldeide e fibra di legno naturale. **Espansi** di poliuretano in densità da 18 kg/mc a 40 kg/mc. **Cuscini** rivestiti in ovatta da 300 gr. **Primo rivestimento** in espanso di poliestere accoppiato a caldo a vellutino aggrappante in poliestere e/o ovatta di poliestere al 100% da 200gr. **Pannelli fondo** contenitore da 12-14 mm in particelle di legno di pioppo in classe E1.

**Technical characteristics**  
**Forgings** fir wood, and/or boxed in poplar plywood. **Panels** 18/25 mm in poplar wood particles class E1 low formaldehyde emission and natural wood fiber. **Polyurethane foam** density from 18 kg/mc to 40 kg/mc. **Cushions** coated with 300 gr wadding. **First coating** hot bonded polyester foam, velvet adhesion in polyester and/or 100% polyester wool, 200gr. **Container bottom panels** 12-14 mm in poplar wood particles class E1.

**Caractéristiques techniques**  
**Tige** en pin et/ou boitiers en multicouche en bois de peuplier. **Panneaux** de 18/25 mm en particules de bois de peuplier classe E1 à faible émission de formaldéhyde et fibre de bois naturelle. **Polyuréthane expansé** densité de 18kg/m<sup>2</sup> à 40kg/m<sup>2</sup>. **Coussin** rembourrés avec de la ouate de 300g. **Premier revêtement** en polyester expansé accouplé à chaud à un velours accrochant en polyester et/ou ouate de polyester à 100% de 200g. **Panneaux de fond coffre rangement** de 12-14mm en particules de bois de peuplier classe E1.

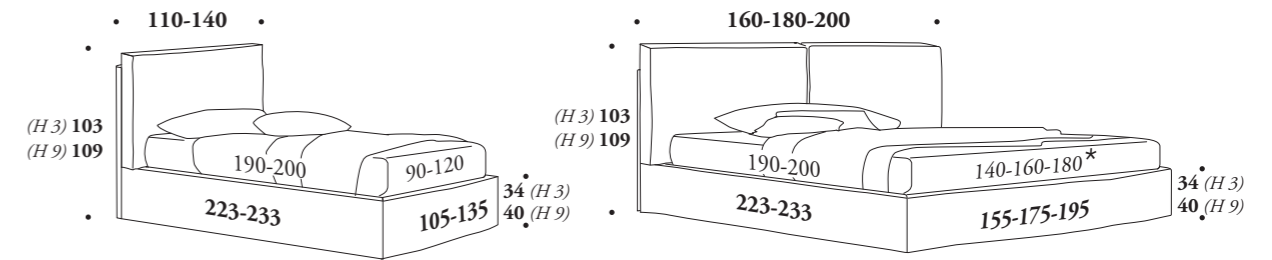

## Ring Eko



**Standard**  
*Basic*  
H 3 cm

wengé  
wengé  
wengé

**Varianti colore / Color variants / Couleurs disponibles**

nero  
black  
noir

bianco  
white  
blanc

argento  
silver  
argent

**Lux**  
H 3 cm

wengé  
wengé  
wengé

nero  
black  
noir

bianco  
white  
blanc

cromo  
chrome  
chrome

**Optional**

**Visual**  
H 9 cm

wengé  
wengé  
wengé

nero  
black  
noir

bianco  
white  
blanc

argento  
silver  
argent



Portagioie  
Jewelry Box  
Porte-bijoux p. 376



Porta USB  
USB holder  
Port USB p. 377



*The stitching, with precise and strong aesthetic impact, outlines the edges of the cushions and bed structure, creating a stylistic and tailoring detail, young and contemporary.*

*La couture, qui a un impact esthétique net et fort, dessine les bords des coussins et de la structure du lit, et recrée un détail stylé et haute couture, jeune et contemporain.*

Meccanica / Mechanism / Mécanique p. 382



248



Maverick

Rete / Support / Sommier p. 380



Armony

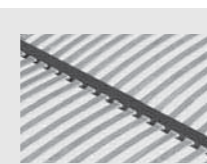

Thai  
46 doghe / slats / lattes

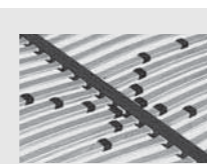

Energy  
Non applicabile a rete da 120 cm  
Not applicable to 120 cm support  
Non applicable au sommier de 120 cm

Tessuto coprirete  
traspirante antipolvere  
Support cover fabric  
breathable and dustproof  
Tissu couvre-sommier  
transpirant anti-poussière

p. 384

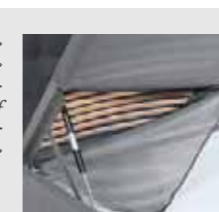

Sacco contenitore  
Multiurpose  
storage bag  
Sac coffre de  
rangement multi  
usage

p. 385

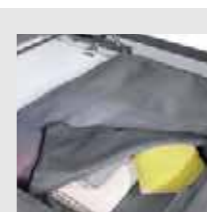

p. 386

Regolatore  
altezza rete  
Support height  
adjuster  
Réglage  
hauteur  
sommier

p. 387



249

**Optional**  
Accessori  
Accessoires



p. 370



p. 368



p. 375

# Night *of* nights

*A complete bedroom collection by Felis*

*Le ore di sonno che precedono la mezzanotte non “valgono di più” di quelle che la seguono. Quindi è sbagliato forzarsi ad andare a letto presto. La strategia migliore è tenere fisso l'orario del risveglio e limitare il tempo che si passa a letto alle ore che si è abituati a dormire, mantenendo anche lì una durata regolare: potrebbero anche essere meno delle famose otto ore.*

*In questo modo può succedere che talvolta si vada a letto più tardi, ma l'esigenza biologica di dormire fa sì che in quei casi ci si addormenti più in fretta e che il sonno sia più profondo.*

*The hours of sleep before midnight are not “worth more” than those that follow. So it is wrong to force yourself to go to bed early. The best strategy is to always wake up at a fixed time and limit the time spent in bed to sleep time, also keeping it regular: it could also be less than the famous eight hours.*

*This way, also when go to bed later, our biological need to sleep allows us to fall asleep faster and makes sleep deeper.*

*Les heures de sommeil qui précèdent minuit ne “valent” pas plus que celles après minuit. On se trompe à vouloir aller au lit tôt. La meilleure stratégie est d'avoir un horaire fixe pour le réveil et limiter la durée passée au lit aux heures de sommeil, et maintenir une durée régulière: qui peut inférieure aux fameuses huit heures.*

*Ce cette manière s'il arrive d'aller au lit plus tard, l'exigence biologique de dormir fait en sorte que l'endormissement soit plus rapide et le sommeil plus profond.*

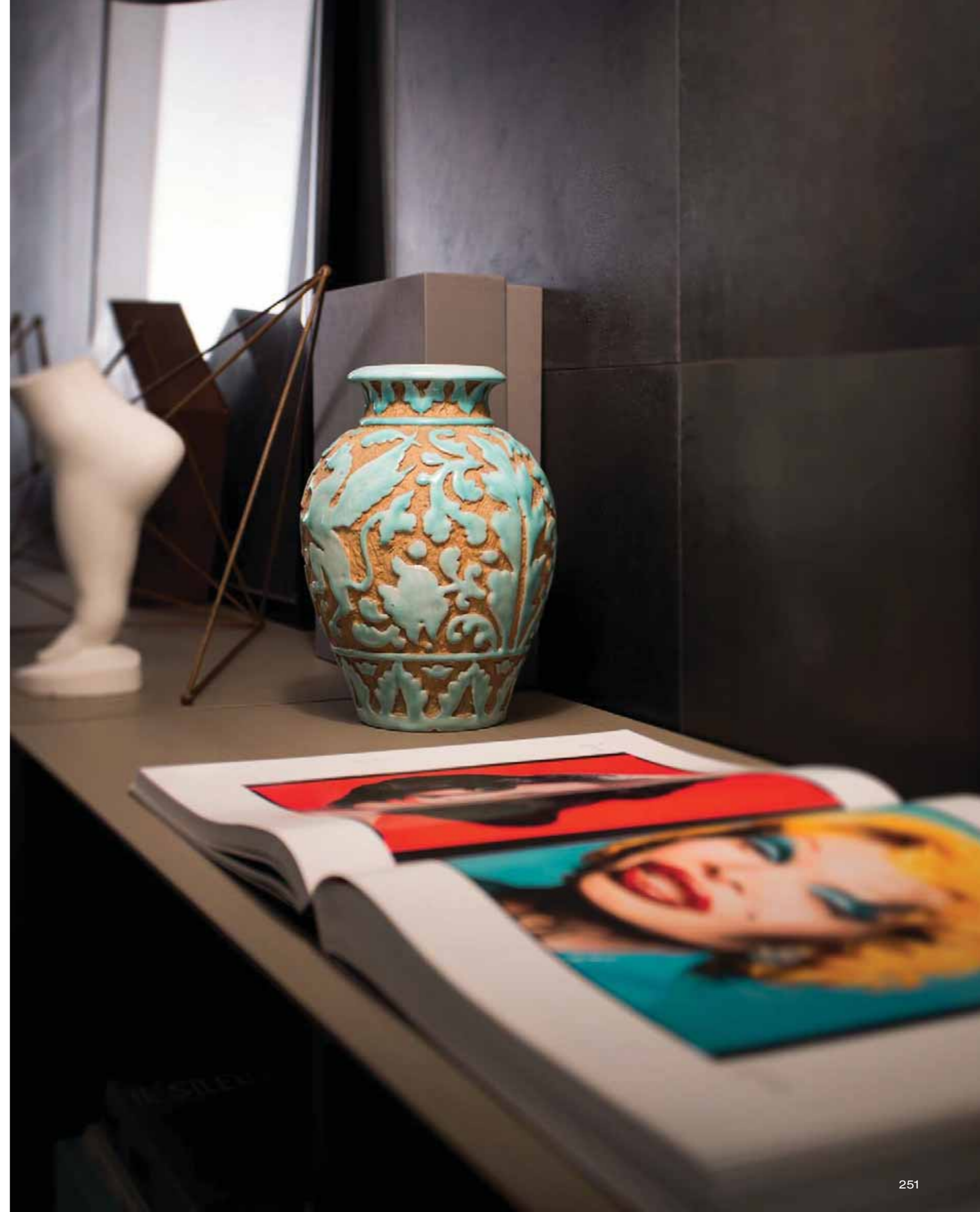

# M Miller







Miller  
- Reversible -



*Ring caratterizzato da un importante piedino in plexiglass che dona leggerezza.*

*Ring characterized by a large Plexiglas foot providing lightness.*

*Le tour de lit est caractérisé par un important pied en plexiglas qui apporte de la légèreté.*



1.

*Il ring alto (1) con cuciture a vista in rilievo con pizzicatura sugli angoli e sul bordo superiore del giroletto. Più lineare, essenziale e pulita la versione con il ring basso (2).*

***Reversible:** è sempre possibile cambiare verso al rivestimento che è uguale nel fronte e nel retro.*



2.

*The high ring (1) with stitching in relief and pinching work on the corners and top edge of the bed frame. More linear, basic and clean, the version with the low ring (2).*

***Reversible:** you can always change side to the cover, which is the same on the front and back.*

*Le tour de lit haut (1) avec couture visibles en relief et pincées sur les angles et sur le bord supérieur du tour de lit. La version tour de lit bas est plus linéaire et essentielle (2).*

***Reversible:** possibilité de changer le côté de revêtement qui est identique des deux côtés.*





# Miller

Completamente sfoderabile  
Totally removable cover  
Complètement déhoussable

\*  
Rete L. 180 cm  
solo profondità 200 cm  
Support W. 180 cm  
only D 200 cm  
Sommier L. 180 cm  
uniquement en  
profondeur 200 cm

## Caratteristiche tecniche

**Masselli** in legno di abete e/o scatolati in multistrato di legno di pioppo. **Pannelli** da 18/25 mm in particelle di legno di pioppo in classe E1 a bassa emissione di formaldeide e fibra di legno naturale. **Espansi** di poliuretano indeformabile a portanza differenziata, densità da 18 kg/mc a 40 kg/mc.

**Primo rivestimento** in espanso di poliester accoppiato a caldo a vellutino aggrappante in poliester e/o ovatta di poliester al 100% da 200gr. **Pannelli fondo** contenitore da 12-14 mm in particelle di legno di pioppo in classe E1.

## Technical characteristics

**Forgings** fir wood, and/or boxed in poplar plywood. **Panels** 18/25 mm in poplar wood particles class E1 low formaldehyde emission and natural wood fiber. **Polyurethane foam**, crushproof, of different capacity, density from 18 kg/mc to 40 kg/mc.

**First coating** hot bonded polyester foam, velvet adhesion in polyester and/or 100% polyester wool, 200gr. **Container bottom panels** 12-14 mm in poplar wood particles class E1.

## Caractéristiques techniques

**Tige** en pin et/ou boîtiers en multicouche en bois de peuplier.

**Panneaux** de 18/25 mm en particules de bois de peuplier classe E1 à faible émission de formaldéhyde et fibre de bois naturelle. **Polyuréthane expansé** indéformable à portée différenciée, densité de 18kg/m<sup>2</sup> à 40kg/m<sup>2</sup>.

**Premier revêtement** en polyester expansé accouplé à chaud à un velours accrochant en polyester et/ou ouate de polyester à 100% de 200g.

**Panneaux de fond coffre rangement** de 12-14mm en particules de bois de peuplier classe E1.

## Ring Smart



### Standard

#### Basic

H 3 cm



wengé  
wengé  
wengé

### Varianti colore / Color variants / Couleurs disponibles



nero  
black  
noir



bianco  
white  
blanc



argento  
silver  
argent

Optional

### Lux

H 3 cm



wengé  
wengé  
wengé



nero  
black  
noir



bianco  
white  
blanc



cromo  
chrome  
chrome

### Visual

H 9 cm



wengé  
wengé  
wengé



nero  
black  
noir



bianco  
white  
blanc



argento  
silver  
argent

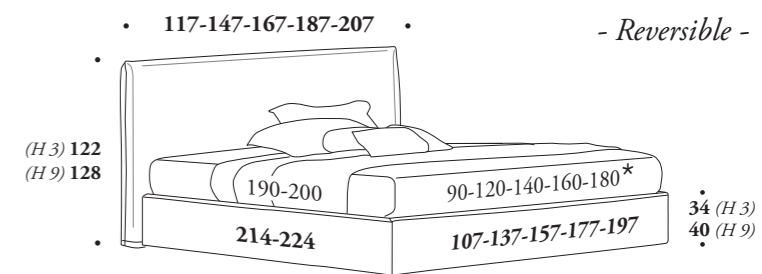

- Reversible -

## Ring York



### Standard

#### Ghost

H 13 cm

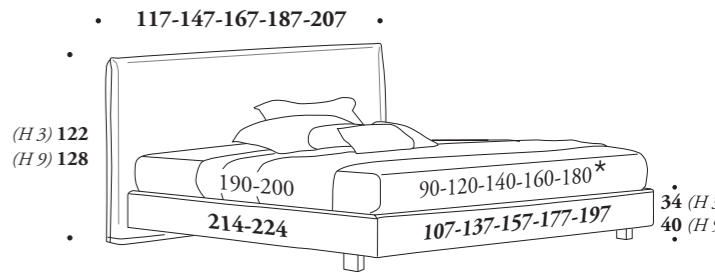

Senza possibilità di contenitore solo con rete fissa  
Without the possibility of container only with fixed support  
Sans possibilité de coffre de rangement uniquement pour sommier fixe

Optional

### Blade

H 13 cm



satinato  
satin  
satiné



bronzato  
bronze  
bronze



tower



plexy

## Optional

Accessori  
Accessoires

Panquette  
Panquette  
Panquette



p. 370

Pouf con  
contenitore  
Pouf with  
container  
Pouf avec  
rangement



p. 368

Sacca  
portaoggetti  
Storage bag  
Sac porte-objets



p. 375

Meccanica / Mechanism / Mécanique p. 382

Rete / Support / Sommier p. 380



Dynamic

260

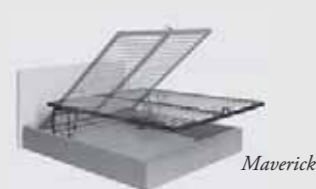

Maverick



Armony

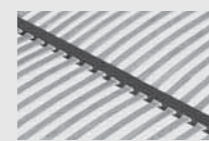

Thai  
46 doghe / slats / lattes

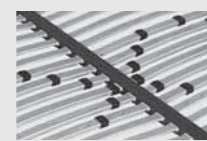

Energy

Non applicabile a rete da 120 cm  
Not applicable to 120 cm support  
Non applicable au sommier de 120 cm

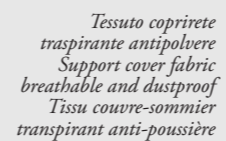

Tessuto coprirete  
traspirante antipolvere  
Support cover fabric  
breathable and dustproof  
Tissu couvre-sommier  
transpirant anti-poussière

p. 384



Sacco contenitore  
multiuso  
Multipurpose  
storage bag  
Sac coffre de  
rangement multi  
usage

p. 385



p. 386

Regolatore  
altezza rete  
Support height  
adjuster  
Réglage  
hauteur  
sommier

p. 387



261

# A Adrian





# Adrian

## 1. DECÓ



*Una cornice telaio contiene la testiera facilmente sfoderabile. Disponibile in tre diverse versioni: Decó (1), Plissé (2) oppure Imperial (3).*

## 2. PLISSÉ



*A frame contains the headboard, which is easily removable. Available in three different versions: Decó (1), Plissé (2) or Imperial (3).*

## 3. IMPERIAL



*Un cadre contient la tête de lit facilement déhoussable. Disponible en trois versions: Decó (1), Plissé (2) or Imperial (3).*





***Comodissimo complemento coordinato alla pediera...***

*Una seduta, un piano d'appoggio e un contenitore con apertura servo assistita. Posizionabile ovunque in camera.*

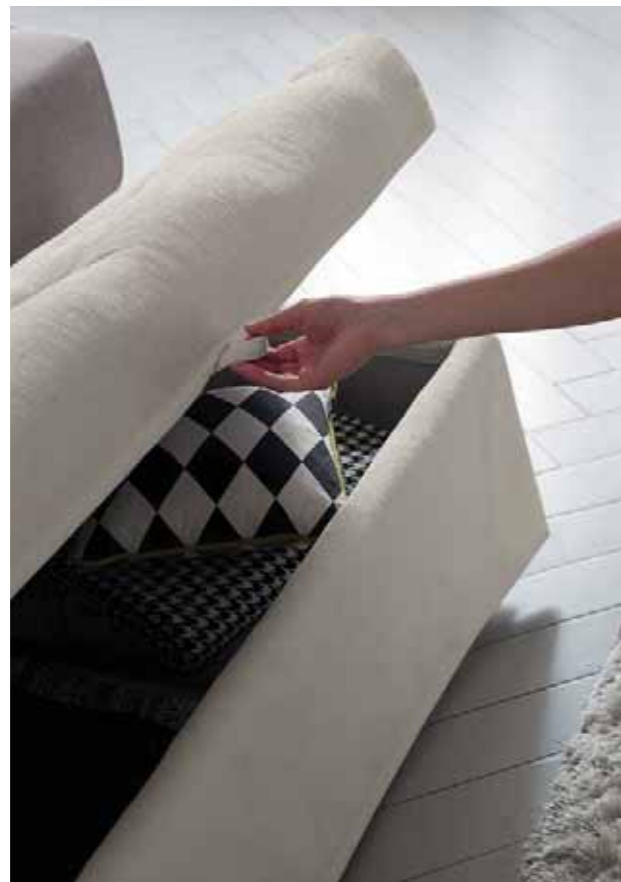

***Convenient coordinated footboard...***

*A seat, a supporting surface and an container with power assisted opening. It can be placed anywhere in the room.*

***Pratique entièrement assorti au pied de lit...***

*Une assise, un plan d'appui et un coffre de rangement à ouverture assistée. Peut être placé n'importe où dans la chambre.*







*La cornice si accompagna  
allo spessore del giroletto e agli  
angoli con gonnella a volant per  
un risultato moderno che non  
rinuncia al gusto della citazione  
classica.*



*The frame is accompanied by  
the thickness of the bed frame  
and the corners with the frilled  
skirt for a modern result that  
does not renounce classic taste.*

*Le cadre accompagne  
l'épaisseur du tour de lit et des  
angles à jupe à volant pour un  
résultat moderne qui ne renonce  
pas au rappel du classique.*

## Adrian

Completamente sfoderabile  
Totally removable cover  
Complètement déhoussable

\*  
Rete L. 180 cm  
solo profondità 200 cm  
Support W. 180 cm  
only D 200 cm  
Sommier L. 180 cm  
uniquement en  
profondeur 200 cm

### Caratteristiche tecniche

**Masselli** in legno di abete e/o  
scatolati in multistrato di legno di  
pioppo. **Pannelli** da 18/25 mm  
in particelle di legno di pioppo  
in classe E1 a bassa emissione  
di formaldeide e fibra di legno  
naturale. **Espansi** di poliuretano  
indeformabile a portanza  
differenziata, densità da 18 kg/  
mc a 40 kg/mc.

**Primo rivestimento** in espanso  
di poliestere accoppiato a caldo  
a vellutino aggrappante in  
poliestere e/o ovatta di poliestere  
al 100% da 200gr. **Pannelli  
fondo** contenitore da 12-14 mm  
in particelle di legno di pioppo in  
classe E1.

### Technical characteristics

**Forgings** fir wood, and/or boxed  
in poplar plywood. **Panels** 18/25  
mm in poplar wood particles  
class E1 low formaldehyde  
emission and natural wood fiber.  
**Polyurethane foam**, crushproof,  
of different capacity, density from  
18 kg/mc to 40 kg/mc.

**First coating** hot bonded  
polyester foam, velvet adhesion  
in polyester and/or 100%  
polyester wool, 200gr. **Container  
bottom panels** 12-14 mm in  
poplar wood particles class E1.

### Caractéristiques techniques

**Tige** en pin et/ou boitiers en  
multicouche en bois de peuplier.  
**Panneaux** de 18/25 mm en  
particules de bois de peuplier  
classe E1 à faible émission  
de formaldéhyde et fibre de  
bois naturelle. **Polyuréthane  
expansé** indéformable à portée  
différenciée, densité de 18kg/m<sup>2</sup>  
à 40kg/m<sup>2</sup>.

**Premier revêtement** en  
polyester expansé accouplé à  
chaud à un velours accrochant  
en polyester et/ou ouate de  
polyester à 100% de 200g.  
**Panneaux de fond coffre**  
**rangement** de 12-14mm en  
particules de bois de peuplier  
classe E1.

Tessuto coprirete  
traspirante antipolvere  
Support cover fabric  
breathable and dustproof  
Tissu couvre-sommier  
transpirant anti-poussière

p. 384

## Ring Smart plus



### Standard

Basic  
H 3 cm



wengé  
wengé  
wengé

Optional

Lux  
H 3 cm



wengé  
wengé  
wengé

## Ring Venice plus



### Varianti colore / Color variants / Couleurs disponibles

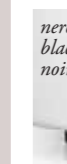

nero  
black  
noir



bianco  
white  
blanc



argento  
silver  
argent

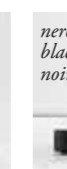

nero  
black  
noir



bianco  
white  
blanc



cromo  
chrome  
chrome



Pannelli testiera in tutte le finiture

Headboard panels in all finishes

Panneaux tête de lit de toutes les finitions



Decò



Plissé



Imperial

### Optional

Accessori  
Accessories  
Accessoires

Panquette  
Panquette  
Panquette



p. 370

Pouf con  
contenitore  
Pouf with  
container  
Pouf avec  
rangement



p. 368

Sacca  
portaoggetti  
Storage bag  
Sac porte-objets



p. 375

Meccanica / Mechanism / Mécanique p. 382

Rete / Support / Sommier p. 380



270

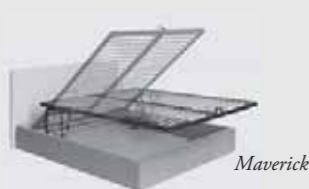

Maverick



Armony

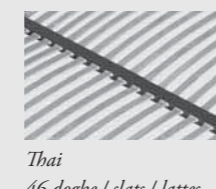

Thai  
46 doghe / slats / lattes



Energy

Non applicabile a rete da 120 cm  
Not applicable to 120 cm support  
Non applicable au sommier de 120 cm

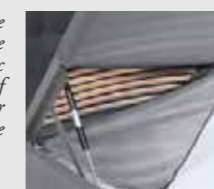

p. 384

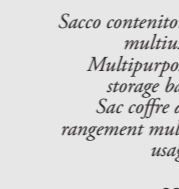

Sacco contenitore  
Multipurpose  
storage bag  
Sac coffre de  
rangement multi  
usage

p. 385



p. 386



Regolatore  
altezza rete  
Support height  
adjuster  
Réglage  
hauteur  
sommier

p. 387



271

# R Ronny





# Ronny

- Reversible -

**Reversible:** è sempre possibile cambiare verso al rivestimento che è uguale nel fronte e nel retro.

**Il design preciso, nitido e geometrico** è ammorbidito dall'effetto tridimensionale della trapuntatura quadra. Rifinisce totalmente la testiera, (adatta anche al centro stanza) e il giroletto in una proposta monocolore.

N.B. La trapuntatura quadra è realizzabile solo con i tessuti Safy

**Reversible:** you can always change side to the cover, which is the same on the front and back.

**The precise and sharp geometric design** is softened by the three-dimensional effect of the square quilting. It totally finishes the headboard, (also placeable in the center of the room) and the bed frame in a single color version.

Note Square quilting is achievable only with fabrics Safy

**Reversible:** possibilité de changer le côté de revêtement qui est identique des deux côtés.

**Le design géométrique net et précis** est adouci par l'effet 3D du matelassage carré. Finition de la tête de lit, (qui est ainsi adaptée à une position au centre de la pièce) et le tour de lit en un seule couleur.

N.B. Le matelassage en carrés est réalisé uniquement avec des tissus Safy





# Ronny

Completamente sfoderabile  
Totally removable cover  
Complètement déhoussable

\*  
Rete L. 180 cm  
solo profondità 200 cm  
Support W. 180 cm  
only D 200 cm  
Sommier L. 180 cm  
uniquement en  
profondeur 200 cm

**Caratteristiche tecniche**  
**Masselli** in legno di abete e/o sciolati in multistrato di legno di pioppo. **Pannelli** da 18/25 mm in particelle di legno di pioppo in classe E1 a bassa emissione di formaldeide e fibra di legno naturale. **Espansi** di poliuretano indeformabile a portanza differenziata, densità da 18 kg/mc a 40 kg/mc.  
**Primo rivestimento** in espanso di poliestere accoppiato a caldo a vellutino aggrappante in poliestere e/o ovatta di poliestere al 100% da 200gr. **Pannelli fondo** contenitore da 12-14 mm in particelle di legno di pioppo in classe E1.

**Technical characteristics**  
**Forgings** fir wood, and/or boxed in poplar plywood. **Panels** 18/25 mm in poplar wood particles class E1 low formaldehyde emission and natural wood fiber. **Polyurethane foam**, crushproof, of different capacity, density from 18 kg/mc to 40 kg/mc.  
**First coating** hot bonded polyester foam, velvet adhesion in polyester and/or 100% polyester wool, 200gr. **Container bottom panels** 12-14 mm in poplar wood particles class E1.

**Caractéristiques techniques**  
**Tige** en pin et/ou boitiers en multicouche en bois de peuplier. **Panneaux** de 18/25 mm en particules de bois de peuplier classe E1 à faible émission de formaldéhyde et fibre de bois naturelle. **Polyuréthane expansé** indéformable à portée différenciée, densité de 18kg/m² à 40kg/m².  
**Premier revêtement** en polyester expansé accouplé à chaud à un velours accrochant en polyester et/ou ouate de polyester à 100% de 200g. **Panneaux de fond coffre rangement** de 12-14mm en particules de bois de peuplier classe E1.

## Ring Smart



Standard  
Basic  
H 3 cm

wengé  
wengé  
wengé



Varianti colore / Color variants / Couleurs disponibles

nero  
black  
noir



bianco  
white  
blanc



argento  
silver  
argent



Lux  
H 3 cm

wengé  
wengé  
wengé



nero  
black  
noir



bianco  
white  
blanc



cromo  
chrome  
chrome



Optional  
Visual  
H 9 cm

wengé  
wengé  
wengé



nero  
black  
noir



bianco  
white  
blanc



argento  
silver  
argent

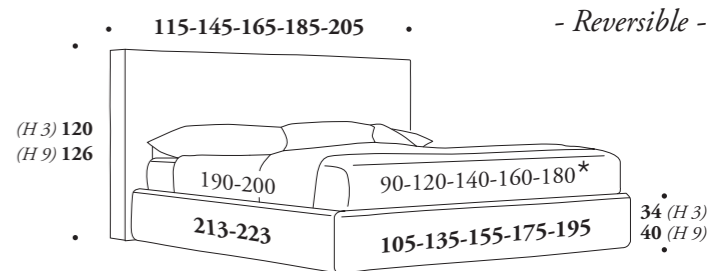

## Ring York



Standard  
Ghost  
H 13 cm

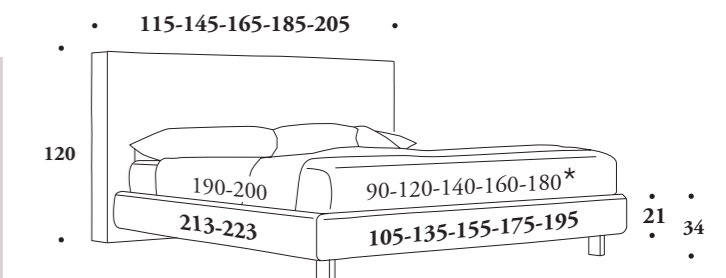

Senza possibilità di contenitore solo con rete fissa  
Without the possibility of container only with fixed support  
Sans possibilité de coffre de rangement uniquement pour sommier fixe

Optional

Blade  
H 13 cm

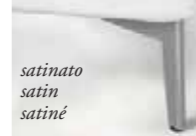

Blade



Tower



Plexy



Optional  
Accessori  
Accessoires  
Accessoires

Panquette  
Panquette  
Panquette



p. 370

Pouf con  
contenitore  
Pouf with  
container  
Pouf avec  
rangement



p. 368

Sacca  
portaoggetti  
Storage bag  
Sac porte-objets



p. 375

Meccanica / Mechanism / Mécanique p. 382



Dynamic

278

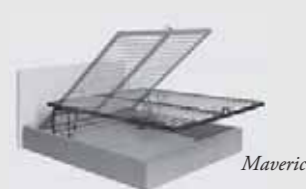

Maverick

Rete / Support / Sommier p. 380



Armony

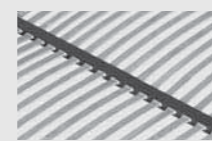

Thai  
46 doghe / slats / lattes

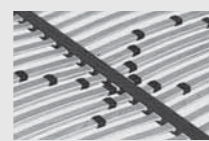

Energy

Non applicabile a rete da 120 cm  
Not applicable to 120 cm support  
Non applicable au sommier de 120 cm

Tessuto coprirete  
traspirante antipolvere  
Support cover fabric  
breathable and dustproof  
Tissu couvre-sommier  
transpirant anti-poussière

p. 384



Sacco contenitore  
multiuso  
Multipurpose  
storage bag  
Sac coffre de  
rangement multi  
usage

p. 385



p. 386

Regolatore  
altezza rete  
Support height  
adjuster  
Réglage  
hauteur  
sommier

p. 387



279

# Dennis





# Dennis







*Sulla testiera il tema geometrico evidenzia lo spessore profondo che si ammorbidisce nei profili arrotondati dei lati.*

*The geometric design on the headboard highlights the deep thickness that softens at the rounded profiles of the sides.*

*Sur la tête de lit le thème géométrique met en évidence l'épaisseur profonde qui s'assouplit avec les profils arrondis des côtés.*





*Le due diverse versioni di giroletto disponibili sottolineano o alleggeriscono l'importanza e la geometria della testiera.*

*The two different versions of the bed frame available emphasize or lighten the importance and the geometry of the headboard.*

*Les deux versions de tour de lit disponibles soulignent ou allègent l'importance et la géométrie de la tête de lit.*

*Bottoni tinta unita, contrasto o Swarovski bianco o nero.  
Buttons in the same color as the fabric or contrasting or black or white Swarovski.  
Boutons couleur tissu ou en contraste ou Swarovsky blanc ou noir.*

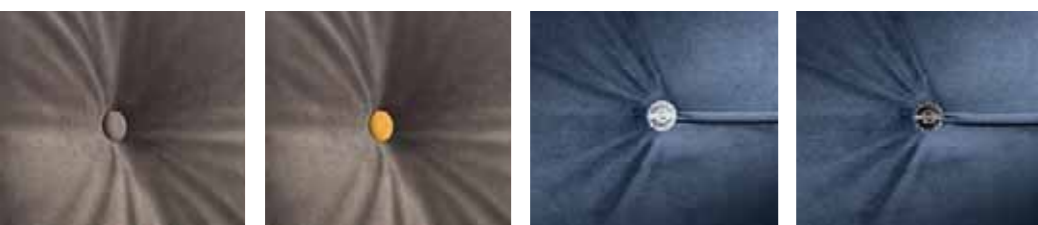

Meccanica / Mechanism / Mécanique p. 382

Rete / Support / Sommier p. 380



288

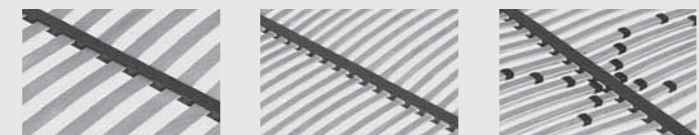

Armony

Thai

Energy

46 doghe / slats / lattes

Non applicabile a rete da 120 cm  
Not applicable to 120 cm support  
Non applicable au sommier de 120 cm

## Dennis

Completamente sfoderabile  
Totally removable cover  
Complètement déhoussable

\*  
Rete L. 180 cm  
solo profondità 200 cm  
Support W. 180 cm  
only D 200 cm  
Sommier L. 180 cm  
uniquement en  
profondeur 200 cm

**Caratteristiche tecniche**  
**Masselli** in legno di abete e/o scatolati in multistrato di legno di pioppo. **Pannelli** da 18/25 mm in particelle di legno di pioppo in classe E1 a bassa emissione di formaldeide e fibra di legno naturale. **Espansi** di poliuretano indeformabile a portanza differenziata, densità da 18 kg/mc a 40 kg/mc.  
**Primo rivestimento** in espanso di poliestere accoppiato a caldo a vellutino aggrappante in poliestere e/o ovatta di poliestere al 100% da 200gr. **Pannelli fondo** contenitore da 12-14 mm in particelle di legno di pioppo in classe E1.

**Technical characteristics**  
**Forgings** fir wood, and/or boxed in poplar plywood. **Panels** 18/25 mm in poplar wood particles class E1 low formaldehyde emission and natural wood fiber. **Polyurethane foam**, crushproof, of different capacity, density from 18 kg/mc to 40 kg/mc.  
**First coating** hot bonded polyester foam, velvet adhesion in polyester and/or 100% polyester wool, 200gr. **Container bottom panels** 12-14 mm in poplar wood particles class E1.

**Caractéristiques techniques**  
**Tige** en pin et/ou boitiers en multicouche en bois de peuplier. **Panneaux** de 18/25 mm en particules de bois de peuplier classe E1 à faible émission de formaldéhyde et fibre de bois naturelle. **Polyuréthane expansé** indéformable à portée différenciée, densité de 18kg/m<sup>2</sup> à 40kg/m<sup>2</sup>.  
**Premier revêtement** en polyester expansé accouplé à chaud à un velours accrochant en polyester et/ou ouate de polyester à 100% de 200g. **Panneaux de fond coffre rangement** de 12-14mm en particules de bois de peuplier classe E1.

Tessuto coprirete  
traspirante antipolvere  
Support cover fabric  
breathable and dustproof  
Tissu couvre-sommier  
transpirant anti-poussière

p. 384



Sacco contenitore  
multipurpose  
storage bag  
Sac coffre de  
rangement multi  
usage

p. 385



p. 386

Regolatore  
altezza rete  
Support height  
adjuster  
Réglage  
hauteur  
sommier

p. 387



289

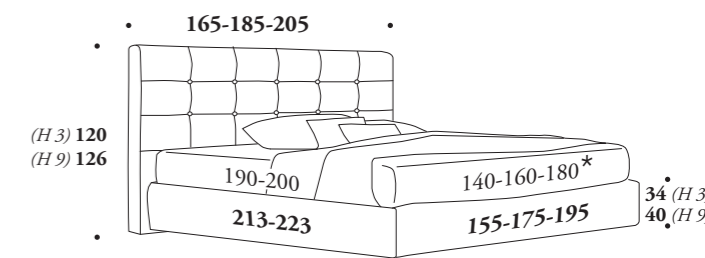

## Ring Smart



Standard  
Basic  
H 3 cm



Varianti colore / Color variants / Couleurs disponibles



Lux  
H 3 cm



Optional

Visual  
H 9 cm



## Ring York



Standard  
Ghost  
H 13 cm

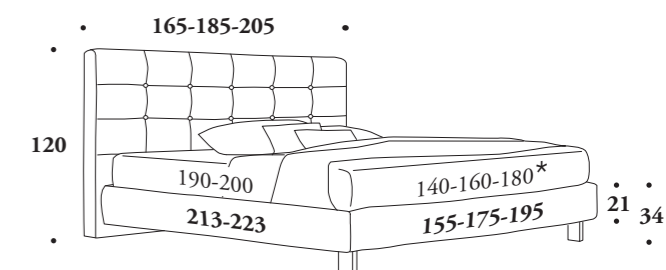

Senza possibilità di contenitore  
solo con rete fissa  
Without the possibility of  
container only with fixed support  
Sans possibilité de coffre de  
rangement uniquement pour  
sommier fixe

Optional

H 13 cm



Optional  
Accessori  
Accessoires

Panquette  
Panquette  
Panquette



p. 370

Pouf con  
contenitore  
Pouf with  
container  
Pouf avec  
rangement



p. 368

Sacca  
portaoggetti  
Storage bag  
Sac porte-objets



p. 375

# Parker





Parker

- Reversible -



*Reversible: è sempre possibile cambiare verso al rivestimento che è uguale nel fronte e nel retro. Un unico grande soffice cuscino per testiera con un bordo importante a volant. Il giroletto si arrotonda verso l'esterno e si allarga verso il basso aumentando la percezione di morbida accoglienza.*



*Reversible: you can always change side to the cover, which is the same on the front and back. A single large soft cushion for the headboard with an large frilled edge. The bed frame is rounded towards the outside and extends downwards increasing the perception of welcoming softness.*

*Reversible: possibilité de changer le côté de revêtement qui est identique des deux côtés. Un coussin unique et moelleux pour la tête de lit avec un important bord à volant. Le tour de lit s'arrondit vers l'extérieur et s'élargit vers le bas pour augmenter la sensation d'enveloppement.*

## Parker

Completamente sfoderabile  
Totally removable cover  
Complètement déhoussable

\*  
Rete L. 180 cm  
solo profondità 200 cm  
Support W. 180 cm  
only D 200 cm  
Sommier L. 180 cm  
uniquement en  
profondeur 200 cm

### Caratteristiche tecniche

**Masselli** in legno di abete e/o scatolati in multistrato di legno di pioppo. **Pannelli** da 18/25 mm in particelle di legno di pioppo in classe E1 a bassa emissione di formaldeide e fibra di legno naturale. **Espansi** di poliuretano indeformabile a portanza differenziata, densità da 18 kg/mc a 40 kg/mc.

**Primo rivestimento** in espanso di poliestere accoppiato a caldo a vellutino aggrappante in poliestere e/o ovatta di poliestere al 100% da 300gr. **Pannelli fondo** contenitore da 12-14 mm in particelle di legno di pioppo in classe E1.

### Technical characteristics

**Forgings** fir wood, and/or boxed in poplar plywood. **Panels** 18/25 mm in poplar wood particles class E1 low formaldehyde emission and natural wood fiber.

**Polyurethane foam**, crushproof, of different capacity, density from 18 kg/mc to 40 kg/mc.

**First coating** hot bonded polyester foam, velvet adhesion in polyester and/or 100% polyester wool, 300gr. **Container bottom panels** 12-14 mm in poplar wood particles class E1.

### Caractéristiques techniques

**Tige** en pin et/ou boitiers en multicouche en bois de peuplier.

**Panneaux** de 18/25 mm en particules de bois de peuplier classe E1 à faible émission de formaldéhyde et fibre de bois naturelle. **Polyuréthane expansé** indéformable à portée différenciée, densité de 18kg/m<sup>2</sup> à 40kg/m<sup>2</sup>.

**Premier revêtement** en polyester expansé accouplé à chaud à un velours accrochant en polyester et/ou ouate de polyester à 100% de 300g.

**Panneaux de fond coffre rangement** de 12-14mm en particules de bois de peuplier classe E1.

## Ring Round



### Standard

Basic  
H 3 cm

wengé  
wengé  
wengé

### Varianti colore / Color variants / Couleurs disponibles

nero  
black  
noir

bianco  
white  
blanc

argento  
silver  
argent

### Optional

Lux  
H 3 cm

wengé  
wengé  
wengé

nero  
black  
noir

bianco  
white  
blanc

cromo  
chrome  
chrome

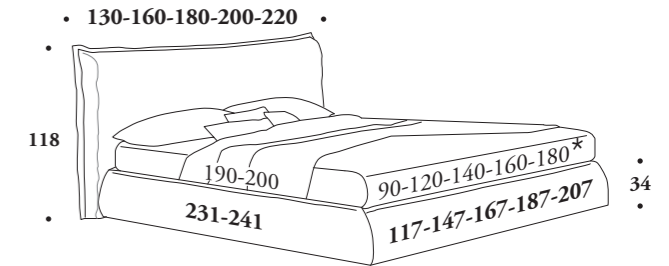

Meccanica / Mechanism / Mécanique p. 382

Rete / Support / Sommier p. 380

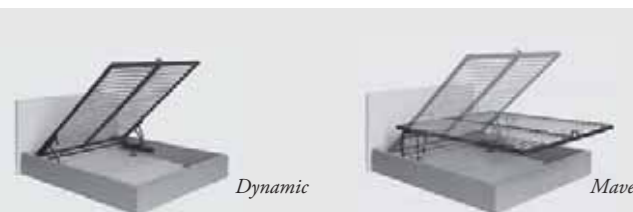

**Armony**  
**Thai**  
46 doghe / slats / lattes  
**Energy**  
Non applicabile a rete da 120 cm  
Not applicable to 120 cm support  
Non applicable au sommier de 120 cm

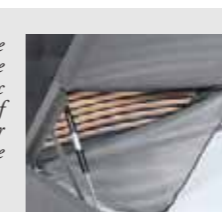

Tessuto coprirete  
traspirante antipolvere  
Support cover fabric  
breathable and dustproof  
Tissu couvre-sommier  
transpirant anti-poussière

p. 384



Sacco contenitore  
Panquette  
Multipurpose  
storage bag  
Sac coffre de  
rangement multi  
usage

p. 385



Clean Up System  
+13 cm

p. 386



Regolatore  
altezza rete  
Support height  
adjuster  
Réglage  
hauteur  
sommier

p. 387

# Clyde





# Clyde



*La testiera alta e squadrata è “segnata” da una particolare trapuntatura a linee verticali. Il progetto è disponibile nelle 2 versioni: più alta a pavimento e più sottile sollevata da piedini a vista.*



*The high and square headboard is “marked” by a particular quilting effect with vertical lines. The project is available in 2 versions, higher on the floor and thinner raised by visible feet.*

*Le tête de lit haute et carrée est marquée par un rembourrage à lignes verticales. Disponible en 2 versions plus haute au sol et plus fine soulevée par des pieds visibles.*

## Clyde

Completamente sfoderabile  
Totally removable cover  
Complètement déhoussable

### Caratteristiche tecniche

**Masselli** in legno di abete e/o scatolati in multistrato di legno di pioppo. **Pannelli** da 18/25 mm in particelle di legno di pioppo in classe E1 a bassa emissione di formaldeide e fibra di legno naturale. **Espansi** di poliuretano indeformabile a portanza differenziata, densità da 18 kg/mc a 40 kg/mc.

**Primo rivestimento** in espanso di poliestere accoppiato a caldo a vellutino aggrappante in poliestere e/o ovatta di poliestere al 100% da 200gr. **Pannelli fondo** contenitore da 12-14 mm in particelle di legno di pioppo in classe E1.

### Technical characteristics

**Forgings** fir wood, and/or boxed in poplar plywood. **Panels** 18/25 mm in poplar wood particles class E1 low formaldehyde emission and natural wood fiber. **Polyurethane foam**, crushproof, of different capacity, density from 18 kg/mc to 40 kg/mc.

**First coating** hot bonded polyester foam, velvet adhesion in polyester and/or 100% polyester wool, 200gr. **Container bottom panels** 12-14 mm in poplar wood particles class E1.

### Caractéristiques techniques

**Tige** en pin et/ou boitiers en multicouche en bois de peuplier.

**Panneaux** de 18/25 mm en particules de bois de peuplier classe E1 à faible émission de formaldéhyde et fibre de bois naturelle. **Polyuréthane expansé** indéformable à portée différenciée, densité de 18kg/m<sup>2</sup> à 40kg/m<sup>2</sup>.

**Premier revêtement** en polyester expansé accouplé à chaud à un velours accrochant en polyester et/ou ouate de polyester à 100% de 200g. **Panneaux de fond coffre rangement** de 12-14mm en particules de bois de peuplier classe E1.

\*  
Rete L. 180 cm  
solo profondità 200 cm  
Support W. 180 cm  
only D 200 cm  
Sommier L. 180 cm  
uniquement en  
profondeur 200 cm

## Ring Smart



Standard  
Basic  
H 3 cm



Varianti colore / Color variants / Couleurs disponibles



Optional

Lux  
H 3 cm



Visual  
H 9 cm

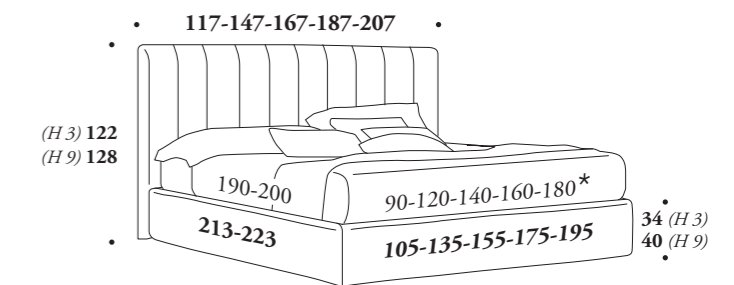

## Ring York



Standard  
Ghost  
H 13 cm



Senza possibilità di contenitore solo con rete fissa  
Without the possibility of container only with fixed support  
Sans possibilité de coffre de rangement uniquement pour sommier fixe

Optional

Blade  
H 13 cm

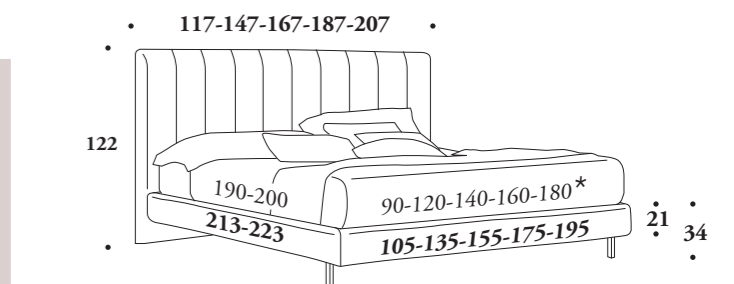

Optional  
Accessori  
Accessoires  
Accessoires

Panquette  
Panquette  
Panquette  
p. 370



Pouf con  
contenitore  
Pouf with  
container  
Pouf avec  
rangement  
p. 368



Sacca  
portaoggetti  
Storage bag  
Sac porte-objets  
p. 375



Meccanica / Mechanism / Mécanique p. 382

Rete / Support / Sommier p. 380

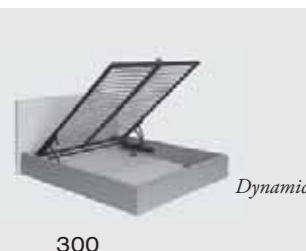

Dynamic

300

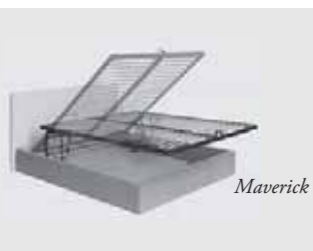

Maverick



Armony

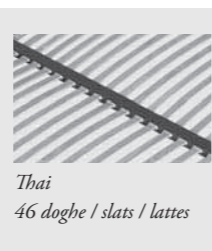

Thai  
46 doghe / slats / lattes

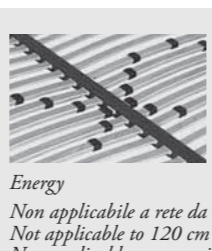

Energy

Non applicabile a rete da 120 cm  
Not applicable to 120 cm support  
Non applicable au sommier de 120 cm

Tessuto coprirete  
traspirante antipolvere  
Support cover fabric  
breathable and dustproof  
Tissu couvre-sommier  
transpirant anti-poussière

p. 384



Sacco contenitore  
Multiuso  
Multipurpose  
storage bag  
Sac coffre de  
rangement multi  
usage

p. 385

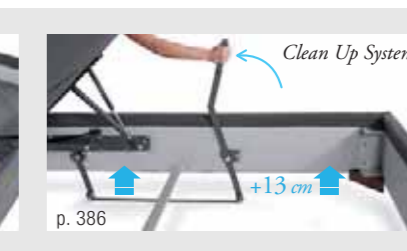

p. 386

Clean Up System

Regolatore  
altezza rete  
Support height  
adjuster  
Réglage  
hauteur  
sommier

p. 387



301



# Night *of* nights

*A complete bedroom collection by Felis*

## ***Come interpretare i nostri sogni?***

*Dalla storia di Giuseppe nella bibbia, al greco Esculapio che guariva le persone facendole sognare, fino a Freud e Jung... Il sogno è sempre stato considerato una chiave di accesso alla parte di noi stessi più profonda, inconscia, quella che governa la nostra vita cosciente. Ma qual è la reale funzione del sogno nella nostra vita... ? Secondo alcune filosofie orientali i sogni ci rivelano le disarmonie presenti nel nostro inconscio per risanarle e farci andare oltre i nostri limiti. Il sogno, come un amico, ci offre soluzioni che, se correttamente interpretate, ci aiutano a superare i nostri disagi.*

## ***How to interpret our dreams?***

*From the story of Joseph in the Bible, to the Greek Aesculapius who healed people causing them to dream, up to Freud and Jung... Dreams have always been considered a key to the deepest part of ourselves, unconscious, one that governs our conscious lives. But what is the real function of dreams in our lives...? According to some Eastern philosophies dreams reveal disharmony in our unconscious to heal them and help us go beyond our limits. Dreams, like friends, offer solutions that, when properly interpreted, help us to overcome our difficulties.*

## ***Comment interpréter nos rêves?***

*De l'histoire de Joseph dans la Bible, au grec Asclépios qui guérissait les personnes en les faisant rêver jusqu'à Freud et Jung... Le rêve a toujours été considéré comme la clé permettant d'accéder à la partie la plus enfouie de notre être, l'inconscient, qui gouverne notre vie consciente. Mais quel est la réelle fonction du sommeil dans notre vie? Selon certaines philosophies orientales les rêves nous révèlent les disharmonies présentes dans notre inconscient pour aider à dépasser nos propres limites. Le sommeil, comme un ami, nous offre des solutions qui, si elles sont correctement interprétées, nous aident à dépasser nos mal-être.*



# C Charles





# Charles

- Reversible -



**Reversible:** è sempre possibile cambiare verso al rivestimento che è uguale nel fronte e nel retro.

**Design di grande pulizia...**

Il bordo a contrasto con il tessuto della testiera e del giroletto evidenzia, disegna e rende preziose forme, spessori e dimensioni.

**Reversible:** you can always change side to the cover, which is the same on the front and back.

**Very clean design...** The edge in contrast with the fabric of the headboard and bed frame shows, marks and makes the shapes, thicknesses, and sizes precious.

**Reversible:** possibilité de changer le côté de revêtement qui est identique des deux côtés.

**Design net,** le bord en contraste avec le tissu de la tête de lit et du tour de lit met en évidence, dessine et rend les formes, les épaisseurs et les dimensions précieuses.





*Le linee minimaliste sono giocate con il bordo a contrasto che rende più solido ed evidente il giroletto.*

*The minimalist lines have a contrasting edge that makes the bed frame look more solid and evident.*

*Les lignes minimalistes jouent avec le bord en contraste qui rend plus solide et évident le tour de lit.*

## Charles

Completamente sfoderabile  
Totally removable cover  
Complètement déhoussable

\*  
Rete L. 180 cm  
solo profondità 200 cm  
Support W. 180 cm  
only D 200 cm  
Sommier L. 180 cm  
uniquement en  
profondeur 200 cm

**Caratteristiche tecniche**  
**Masselli** in legno di abete e/o scatolati in multistrato di legno di pioppo. **Pannelli** da 18/25 mm in particelle di legno di pioppo in classe E1 a bassa emissione di formaldeide e fibra di legno naturale. **Espansi** di poliuretano indeformabile a portanza differenziata, densità da 18 kg/mc a 40 kg/mc.  
**Primo rivestimento** in espanso di poliestere accoppiato a caldo a vellutino aggrappante in poliestere e/o ovatta di poliestere al 100% da 200gr. **Pannelli fondo** contenitore da 12-14 mm in particelle di legno di pioppo in classe E1.

**Technical characteristics**  
**Forgings** fir wood, and/or boxed in poplar plywood. **Panels** 18/25 mm in poplar wood particles class E1 low formaldehyde emission and natural wood fiber. **Polyurethane foam**, crushproof, of different capacity, density from 18 kg/mc to 40 kg/mc.  
**First coating** hot bonded polyester foam, velvet adhesion in polyester and/or 100% polyester wool, 200gr. **Container bottom panels** 12-14 mm in poplar wood particles class E1.

**Caractéristiques techniques**  
**Tige** en pin et/ou boitiers en multicouche en bois de peuplier. **Panneaux** de 18/25 mm en particules de bois de peuplier classe E1 à faible émission de formaldehyde et fibre de bois naturelle. **Polyuréthane expansé** indéformable à portée différenciée, densité de 18kg/m<sup>2</sup> à 40kg/m<sup>2</sup>.  
**Premier revêtement** en polyester expansé accouplé à chaud à un velours accrochant en polyester et/ou ouate de polyester à 100% de 200g. **Panneaux de fond coffre rangement** de 12-14mm en particules de bois de peuplier classe E1.

## Ring Smart



Standard  
Basic  
H 3 cm



Varianti colore / Color variants / Couleurs disponibles



Optional

Lux  
H 3 cm

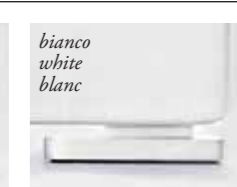

Visual  
H 9 cm

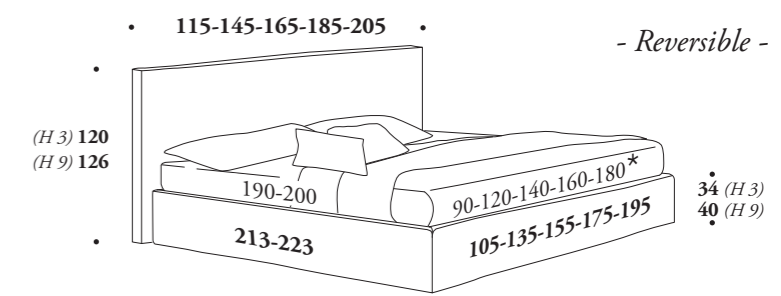

## Ring York



Standard  
Ghost  
H 13 cm

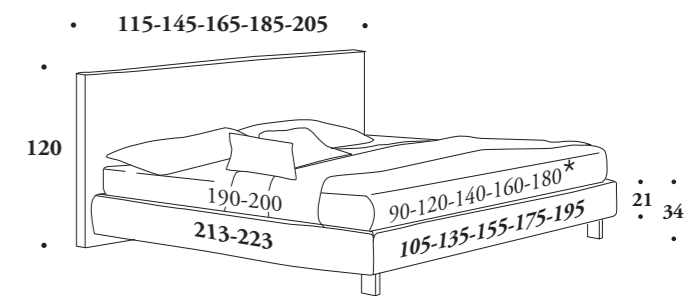

Senza possibilità di contenitore solo con rete fissa  
Without the possibility of container only with fixed support  
Sans possibilité de coffre de rangement uniquement pour sommier fixe

Optional

Blade  
H 13 cm



Optional  
Accessori  
Accessoires

Panquette  
Panquette  
Panquette  
p. 370



Pouf con  
contenitore  
Pouf with  
container  
Pouf avec  
rangement  
p. 368



Sacca  
portaoggetti  
Storage bag  
Sac porte-objets  
p. 375



Meccanica / Mechanism / Mécanique p. 382

Rete / Support / Sommier p. 380



312

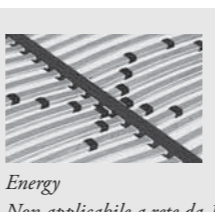
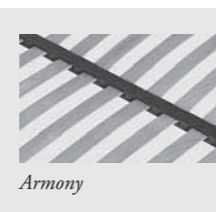

Non applicabile a rete da 120 cm  
Not applicable to 120 cm support  
Non applicable au sommier de 120 cm

Tessuto coprirete  
traspirante antipolvere  
Support cover fabric  
breathable and dustproof  
Tissu couvre-sommier  
transpirant anti-poussière

p. 384

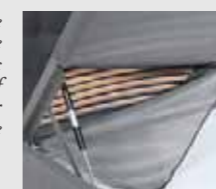

Sacco contenitore  
Multiuso  
Multipurpose  
storage bag  
Sac coffre de  
rangement multi  
usage

p. 385



p. 386

Regolatore  
altezza rete  
Support height  
adjuster  
Réglage  
hauteur  
sommier

p. 387



313

# Night *of* nights

*A complete bedroom collection by Felis*

*La parola notte deriva dal latino “Nox” (“Nyx” in greco) che a sua volta deriva dal sanscrito “Nac”, che vuol dire “tempo nel quale sparisce la luce”. L’espressione “passare la notte in bianco” deriva invece da una tradizione del Medioevo. I cavalieri trascorrevano la notte precedente l’investitura in una cappella, in preghiera e in meditazione, indossando una veste bianca, simbolo di purezza.*

*The word night comes from the Latin “Nox” (“Nyx” in Greek) which in turn is derived from the Sanskrit “Nac”, which means “the time in which the light disappears.” The expression “to spend the night in white” derives from a tradition of the Middle Ages. Knights used to spend the night before the investiture in a chapel, in prayer and meditation, wearing a white robe, a symbol of purity.*

*Le mot nuit vient du latin “Nox” (“Nyx” en grec) qui dérivait du sanscrit “Nac” qui signifie “durée pendant laquelle la lumière disparaît”. L’expression “passer une nuit blanche” vient d’une tradition du Moyen-âge. Les chevaliers passaient la nuit précédent leur investiture dans une chapelle, à prier et à méditer, en portant un habit blanc, symbole de pureté.*

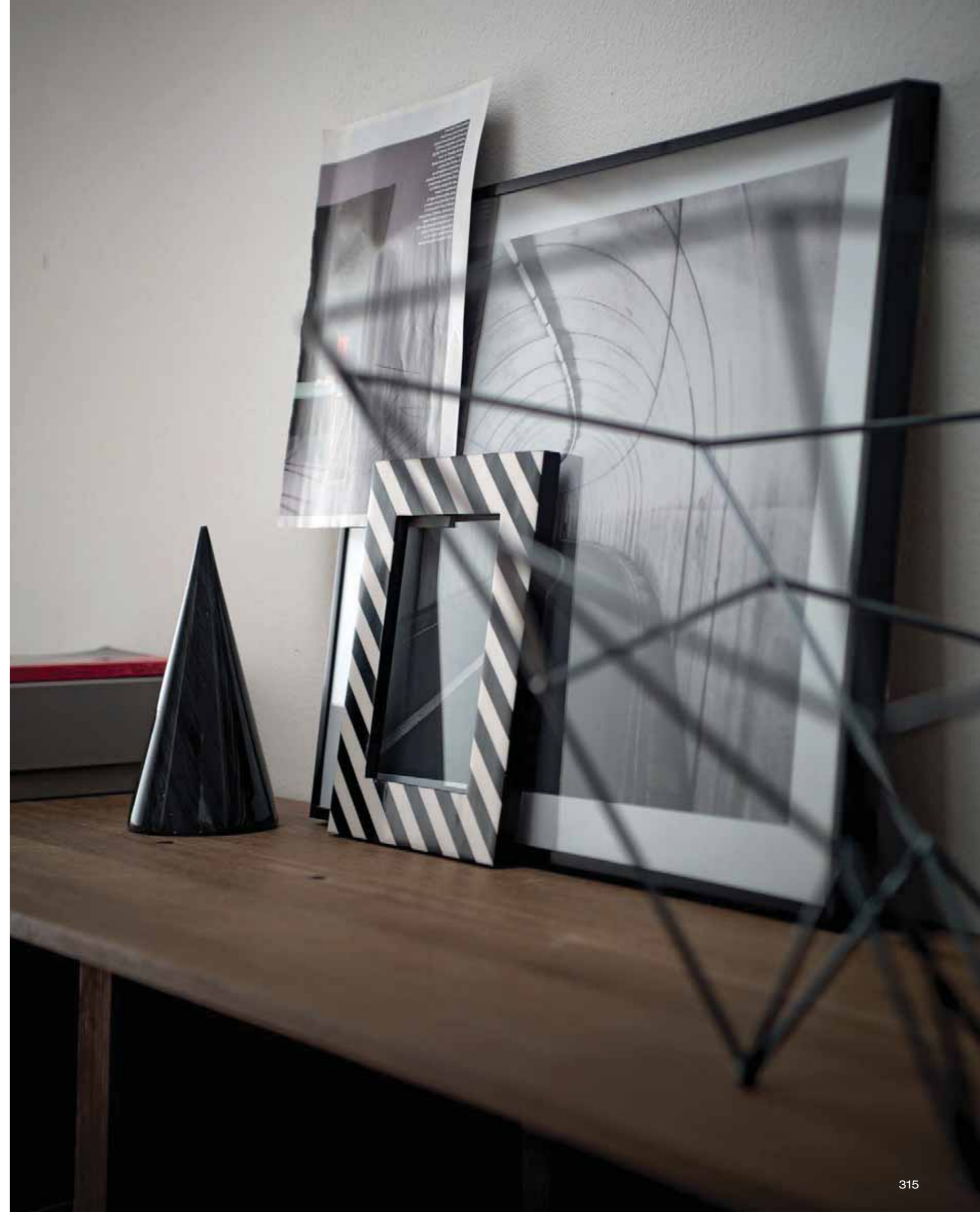

# H Henry







# Henry

- Relax System -



*Un bordo semplice, effetto pizzicato sottolinea la pulizia del disegno nei grandi cuscini e sugli angoli esterni del giroletto. Alla base della testiera, sul piano letto il comodo portaoggetti.*

*A simple edge with a pinched effect emphasizes the clean design of the large pillows and the outer corners of the bed frame. At the base of the headboard at the level of the bed lies the convenient storage bag.*

*Un bord simple, effet pincé, souligne la netteté du dessin des grands coussins et sur les angles externes du tout de lit. À la base de la tête de lit, sur le bord du lit un pratique porte-objets.*



Portagioie p. 376  
Jewelry Box - Porte-bijoux



Porta USB p. 377  
USB holder - Port USB

## Henry

Completamente sfoderabile  
Totally removable cover  
Complètement déhoussable

\*  
Rete L. 180 cm  
solo profondità 200 cm  
Support W. 180 cm  
only D 200 cm  
Sommier L. 180 cm  
uniquement en  
profondeur 200 cm

**Caratteristiche tecniche**  
**Masselli** in legno di abete e/o sciolati in multistrato di legno di pioppo. **Pannelli** da 18/25 mm in particelle di legno di pioppo in classe E1 a bassa emissione di formaldeide e fibra di legno naturale. **Espansi** di poliuretano in densità da 18 kg/mc a 40 kg/mc. **Cuscini** rivestiti in ovatta da 300 gr. **Primo rivestimento** in espanso di poliestere accoppiato a caldo a vellutino aggrappante in poliestere e/o ovatta di poliestere al 100% da 200gr. **Pannelli fondo** contenitore da 12-14 mm in particelle di legno di pioppo in classe E1.

**Technical characteristics**  
**Forgings** fir wood, and/or boxed in poplar plywood. **Panels** 18/25 mm in poplar wood particles class E1 low formaldehyde emission and natural wood fiber. **Polyurethane foam** density from 18 kg/mc to 40 kg/mc. **Cushions** coated with 300 gr wadding. **First coating** hot bonded polyester foam, velvet adhesion in polyester and/or 100% polyester wool, 200gr. **Container bottom panels** 12-14 mm in poplar wood particles class E1.

**Caractéristiques techniques**  
**Tige** en pin et/ou boitiers en multicouche en bois de peuplier. **Panneaux** de 18/25 mm en particules de bois de peuplier classe E1 à faible émission de formaldéhyde et fibre de bois naturelle. **Polyuréthane expansé** densité de 18kg/m<sup>2</sup> à 40kg/m<sup>2</sup>. **Coussin** rembourrés avec de la ouate de 300g. **Premier revêtement** en polyester expansé accouplé à chaud à un velours accrochant en polyester et/ou ouate de polyester à 100% de 200g. **Panneaux de fond coffre rangement** de 12-14mm en particules de bois de peuplier classe E1.

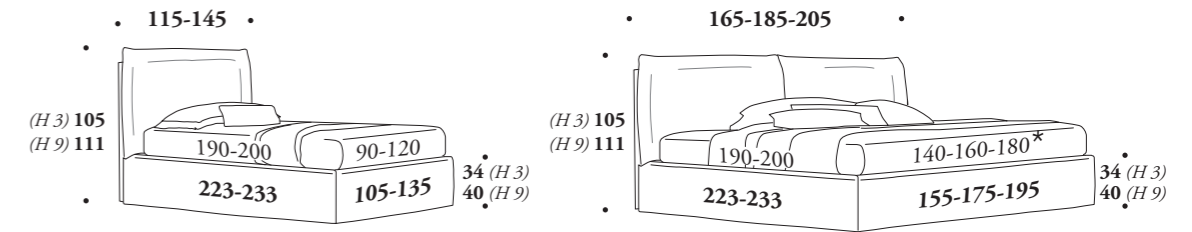

## Ring Eko



Standard  
Basic  
H 3 cm

wengé  
wengé  
wengé

Varianti colore / Color variants / Couleurs disponibles

nero  
black  
noir

bianco  
white  
blanc

argento  
silver  
argent

Lux  
H 3 cm

wengé  
wengé  
wengé

nero  
black  
noir

bianco  
white  
blanc

romo  
chrome  
chrome

Optional

Visual  
H 9 cm

wengé  
wengé  
wengé

nero  
black  
noir

bianco  
white  
blanc

argento  
silver  
argent

Optional  
Accessori  
Accessoires

Panquette  
Panquette  
Panquette



p. 370

Pouf con  
contenitore  
Pouf with  
container  
Pouf avec  
rangement



p. 368

Sacca  
portaoggetti  
Storage bag  
Sac porte-objets



p. 375

Meccanica / Mechanism / Mécanique p. 382

Rete / Support / Sommier p. 380



Dynamic

320



Maverick

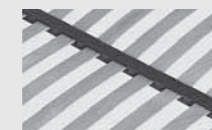

Armony

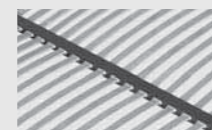

Thai  
46 doghe / slats / lattes

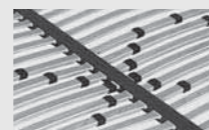

Energy  
Non applicabile a rete da 120 cm  
Not applicable to 120 cm support  
Non applicable au sommier de 120 cm

Tessuto coprirete  
traspirante antipolvere  
Support cover fabric  
breathable and dustproof  
Tissu couvre-sommier  
transpirant anti-poussière

p. 384



Sacco contenitore  
Multiuso  
Multipurpose  
storage bag  
Sac coffre de  
rangement multi  
usage

p. 385



p. 386

Clean Up System

Regolatore  
altezza rete  
Support height  
adjuster  
Réglage  
hauteur  
sommier

p. 387



321

# Sommier

*Molto più di un letto.*

**Il contract di qualità.**

*Un programma articolato e ricco di sommier imbottiti e completi di sistema di boiserie componibile. Tutti completamente sfoderabili. Piani letto / supporti per il materasso in tessuto tridimensionale ignifugo e traspirante o con rete a doghe. Bassi a pavimento o alti, con piedini o ruote per una facile movimentazione e componibilità e bloccaggio. La boiserie modulare completa di comodi piani vassoio posizionabili a piacere è utilizzabile per le testiere, per laterali o arredo in genere.*

**Much more than a bed.**

**Quality contract**  
*A detailed program rich in padded box springs, complete with modular wall panel. All completely removable. Beds / mattress supports in three-dimensional flame retardant and breathable fabric, or slatted. Low on the floor or high. Always with legs and wheels for easy handling and modularity, as well as with locking system. The modular wall panel, complete with handy table trays that can be positioned anywhere, is used for the headboards, side panels, or furniture in general.*

**Plus qu'un simple lit.**

**Le contrat de qualité**  
*Une proposition articulée et riche de sommier rembourrés avec système de boiserie à assembler. Tous entièrement déhoussables. Base lit/support pour le matelas en tissu 3D ignifuge et transpirant ou avec sommier à latte. Bas au sol ou hauts. Toujours avec pieds ou roues pour un déplacement facile, assemblage et blocage. La boiserie modulaire avec des plateaux qui peuvent se placer où l'on veut peut être utilisées pour les têtes de lit, les bords ou un meuble en général.*





Sommier *collection*





A.



B.

**Versione sommier  
matrimoniale**

Disponibile con rete a doghe.  
Possibilità di avere  
cassettone (C), o letto singolo  
estraibile con apertura  
automatica (A) o apertura  
semiautomatica (B).

**Queen size box  
spring version**

Available with  
slatted support.  
Possibility to have a big  
drawer (C) or pull-out twin  
bed with automatic (A) or  
semiautomatic opening (B).

**Version sommier  
deux places**

Disponibile avec  
sommier à lattes.  
Possibilité d'avoir un grand  
 tiroir (C), ou un lit 1 place  
extractible avec ouverture  
automatica (A) ou semi-  
automatica (B).

C.





La boiserie modulare completa di comodi piani vassoio posizionabili a piacere è utilizzabile per le testiere, per laterali o arredo in genere.

The modular wall panel, complete with handy table trays that can be positioned anywhere, is used for the headboards, side panels, or furniture in general.

La boiserie modulare avec des plateaux qui peuvent se placer où l'on veut peut être utilisées pour les têtes de lit, les bords ou un meuble en général.

## Sommier

Completamente sfoderabile  
Totally removable cover  
Complètement déhoussable

\*  
Rete L. 180 cm  
solo profondità 200  
Support W. 180 cm only  
D 200  
Sommier L. 180 cm  
uniquement en  
profondeur 200 cm

### Caratteristiche tecniche

**Masselli** in legno di abete e/o sciolati in multistrato di legno di pioppo. **Pannelli** da 18/25 mm in particelle di legno di pioppo in classe E1 a bassa emissione di formaldeide e fibra di legno naturale. **Espansi** di poliuretano indeformabile a portanza differenziata, densità da 18 kg/mc a 40 kg/mc.

**Primo rivestimento** in espanso di poliestere accoppiato a caldo a vellutino aggrappante in poliestere e/o ovatta di poliestere al 100% da 200gr. **Pannelli fondo** contenitore da 12-14 mm in particelle di legno di pioppo in classe E1.

### Technical characteristics

**Forgings** fir wood, and/or boxed in poplar plywood. **Panels** 18/25 mm in poplar wood particles class E1 low formaldehyde emission and natural wood fiber.

**Polyurethane foam**, crushproof, of different capacity, density from 18 kg/mc to 40 kg/mc.

**First coating** hot bonded polyester foam, velvet adhesion in polyester and/or 100% polyester wool, 200gr. **Container bottom panels** 12-14 mm in poplar wood particles class E1.

### Caractéristiques techniques

**Tige** en pin et/ou boîtiers en multicouche en bois de peuplier.

**Panneaux** de 18/25 mm en particules de bois de peuplier classe E1 à faible émission de formaldéhyde et fibre de bois naturelle. **Polyuréthane expansé** indéformable à portée différenciée. densité de 18kg/m<sup>2</sup> à 40kg/m<sup>2</sup>.

**Premier revêtement** en polyester expansé accouplé à chaud à un velours accrochant en polyester et/ou ouate de polyester à 100% de 200g.

**Panneaux de fond coffre rangement** de 12-14mm en particules de bois de peuplier classe E1.

## Ring Star

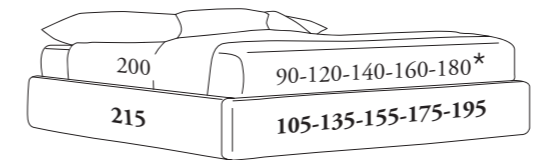

Apertura automatica  
Automatic opening  
Ouverture automatique  
p. 328

## Ring Moon

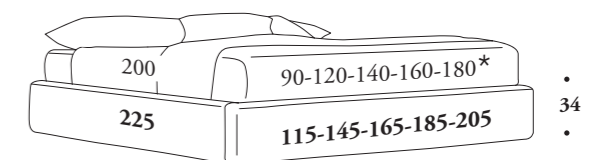

Apertura semi-automatica  
Semiautomatic opening  
Ouverture semi-automatique  
p. 328



Contenitore a cassetto  
Box container  
Coffre de rangement à tiroir  
p. 329

Rete / Support / Sommier p. 382

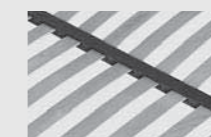

Armony

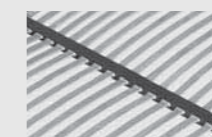

Thai  
46 dogbe / slats / lattes

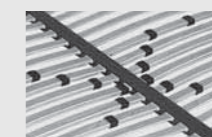

Energy

Non applicabile a rete da 120 cm  
Not applicable to 120 cm support  
Non applicable au sommier de 120 cm



Sacco contenitore multiuso  
Multipurpose storage bag  
Sac coffre de rangement multi usage

p. 387

*Molto più di un letto.*



*Sommier collection*

*- Ring Sky -*





*Sommier disponibili con piedini finitura alluminio dotati di ruote per facile movimentazione o cambio di assetto. Boiserie dalla modularità funzionale all'utilizzo in qualunque soluzione di ambiente.*



*Box spring available with feet with aluminum finish with wheels for easy handling or change of position. Wall panel with functional modularity for use in any environment.*

*Sommiers disponibles avec pieds aluminium et roues pour un déplacement facile ou un changement de place. Boiserie modulaire pour être utilisé dans toutes les solutions d'ameublement.*

*La boiserie modulare può essere attrezzata con piani di appoggio in opalino, disponibili a forma ovale e rettangolare.*

*I vassoi sono facilmente inseribili senza alcun fissaggio e possono essere sempre posizionati ovunque o spostati all'occorrenza con estrema facilità.*

*The modular wall panels can be fitted with shelves in opaline, available in oval and rectangular shape. The trays can be easily inserted without any fixing and can always be positioned anywhere or moved with extreme ease.*

*La boiserie modulaire peut être équipée de plans d'appui en opaline, disponible dans formes ovale ou rectangulaire. Les plateaux s'insèrent facilement sans aucune fixation et peuvent être placés partout ou déplacés très facilement en fonction des besoins.*





Sommier *collection*

- Ring Ocean -



A.

*Un programma pratico e versatile.*

*Gli stessi due sommieri possono diventare un angolo giorno living, una camera a due letti singoli o una camera con letto matrimoniale.*



B.

*A practical and versatile program:*

*the same two boxsprings can become a living corner for the day a bedroom with two single beds a bedroom with a queen bed.*



C.

*Une solution pratique et versatile: les deux sommiers peuvent devenir un coin séjour une chambre à deux lits 1 place une chambre à un lit 2 places.*

*Per il blocco e lo sblocco dei piani letto nelle diverse versioni, un sistema semplice, robusto e veloce con cinghie e fibbie a scatto. Pratici piani di appoggio ovali o rettangolari da posizionare a piacere.*



*For locking and unlocking the bed surface in different versions, a simple, robust and fast system with straps and buckles. Practical oval or rectangular bases to be placed at will.*



*Pour le blocage et le déblocage des bases lit, de différentes versions, un système simple, solide et rapide avec sangles et boucles. De pratiques plans d'appui ovales ou rectangulaires à placer où l'on veut.*

*Il piano letto del sommier per il sostegno del materasso in questa versione è realizzato in tessuto 3D, il massimo per la traspirazione del materasso e per il controllo termico.  
Massimo comfort, igiene e praticità.*

*In this version, the box spring's top for supporting the mattress is made of 3D fabric, the top for the transpiration of the mattress and for thermal control.  
Maximum comfort, hygiene and convenience.*

*La base du sommier pour le soutien du matelas dans cette version est réalisée en tissu 3D, idéal pour la transpiration du matelas et pour le contrôle thermique.  
Confort maximal, hygiène et commodité.*



# Boiserie componibile

*Change when you want, will be very easy.*

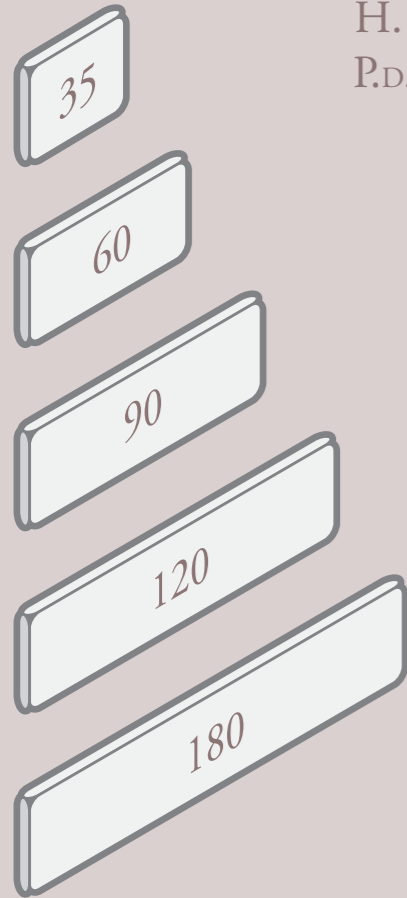

H. 35 cm  
P.D.P. 7 cm

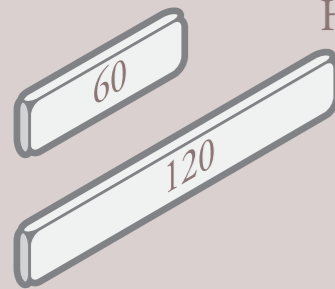

H. 17,5 cm  
P.D.P. 7 cm

*7 moduli per infinite soluzioni.  
I moduli della boiserie componibile.*

*7 modules for endless solutions.  
The modules of the wall panels.*

*7 modules pour une infinités de  
solutions. Les éléments de la boiserie  
sont modulaires.*

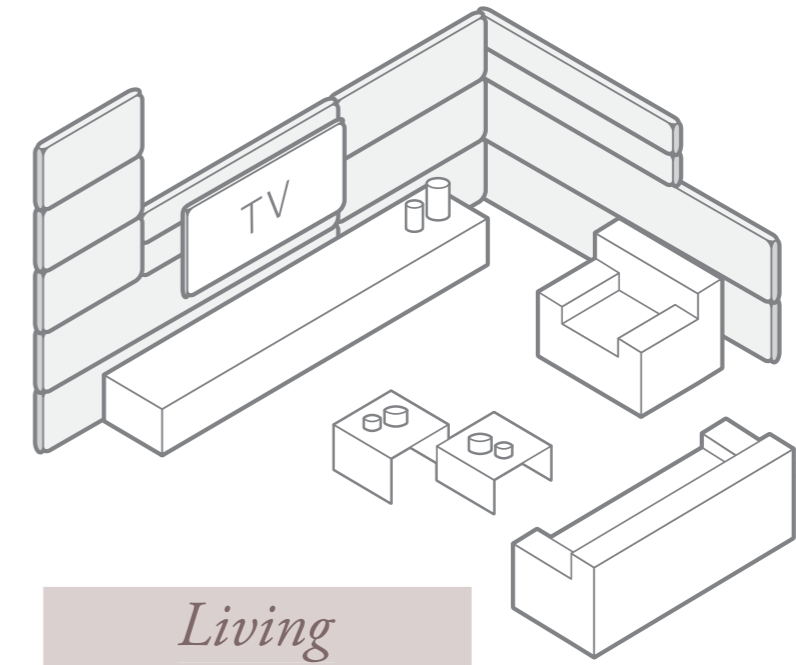
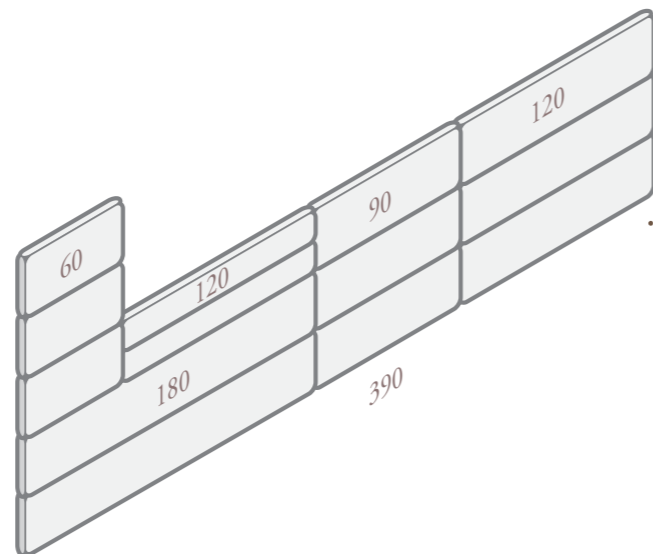
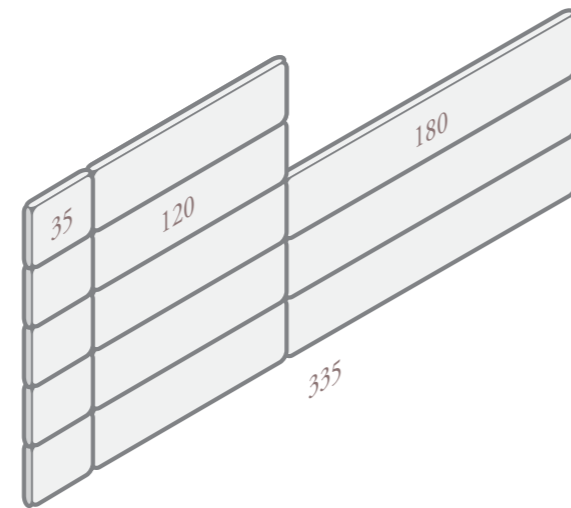
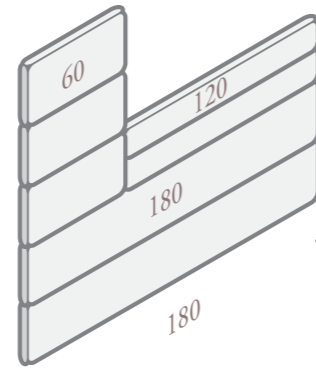

*Living*

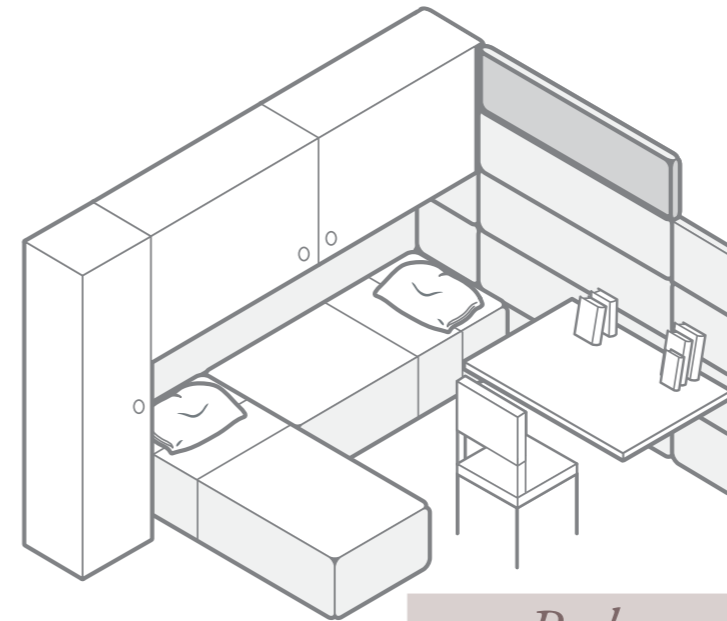

*Bedroom*

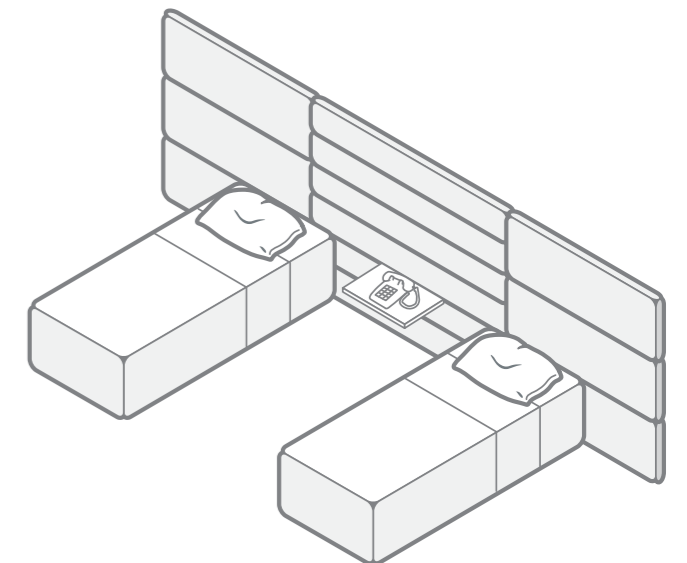

*Contract*

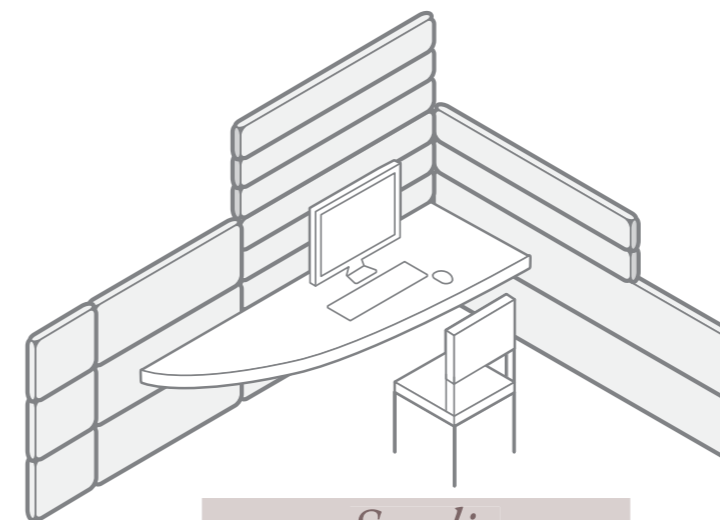

*Studio*

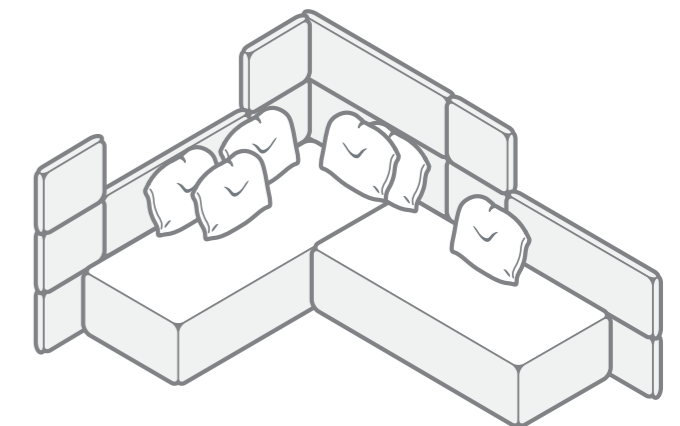

*Relax*

Sommier con tessuto 3D senza rete  
 Box spring with 3D fabric without support  
 Sommier avec tissu 3D

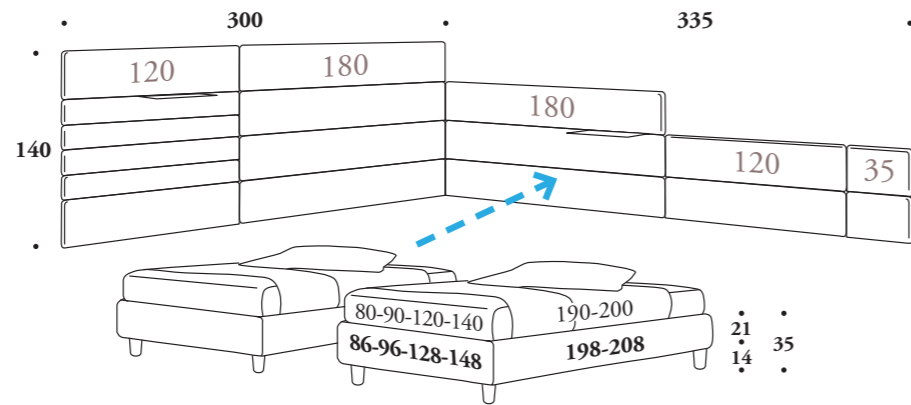

p. 332

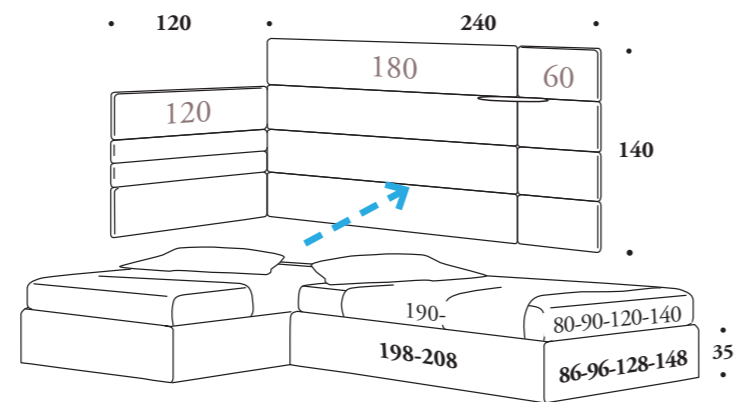
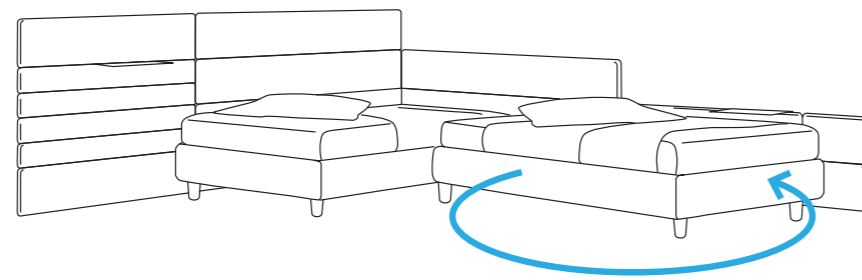

p. 338

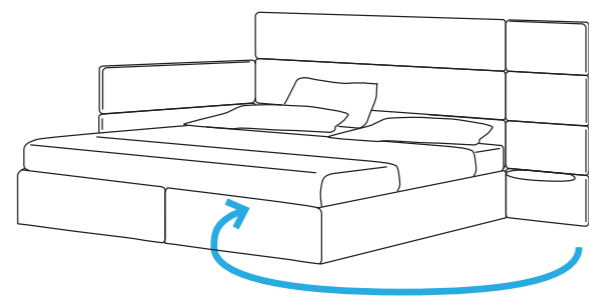

Sommier

Completamente sfoderabile  
 Totally removable cover  
 Complètement déhoussable

**Caratteristiche tecniche**  
**Masselli** in legno di abete e/o sciolati in multistrato di legno di pioppo. **Pannelli** da 18/25 mm in particelle di legno di pioppo in classe E1 a bassa emissione di formaldeide e fibra di legno naturale. **Espansi** di poliuretano indeformabile a portata differenziata, densità da 18 kg/mc a 40 kg/mc.  
**Primo rivestimento** in espanso di poliestere accoppiato a caldo a vellutino aggrappante in poliestere e/o ovatta di poliestere al 100% da 200gr.

**Technical characteristics**  
**Forgings** fir wood, molded poplar plywood. **Panels** 18/25 mm in poplar wood particles class E1 low formaldehyde emission and natural wood fiber. **Polyurethane foam**, crushproof, of different capacity, density from 18 kg/mc to 40 kg/mc.  
**First coating** hot bonded polyester foam, velvet adhesion in polyester and/or 100% polyester wool, 200gr.

**Caractéristiques techniques**  
**Tige** en pin, cadre en multicouche de peuplier. **Panneaux** de 18/25 mm en particules de bois de peuplier classe E1 à faible émission de formaldéhyde et fibre de bois naturelle. **Polyuréthane expansé** indéformable à portée différenciée, densité de 18kg/m<sup>2</sup> à 40kg/m<sup>2</sup>.  
**Premier revêtement** en polyester expansé accouplé à chaud à un velours accrochant en polyester et/ou ouate de polyester à 100% de 200g.

Ring ocean



Standard

Due piedi in ABS (H 4 cm) e due piccole ruote antitraccia (H 4 cm)  
 Two feet in ABS (H 4 cm) and two small wheels (H 4 cm)  
 Deux pieds en ABS (H 4 cm) et deux petites roues anti-coulissement (H 4 cm)

Ring sky

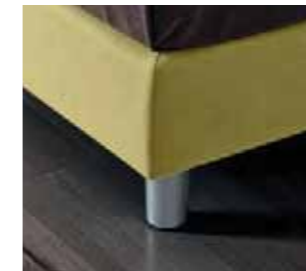

Standard

2 Palace

H 14 cm



2 Palace con ruote antisdrucciolo  
 2 Palace with small wheels  
 2 Palace avec roulettes anti-trace

H 14 cm



Optional

2 Palace

H 14 cm



2 Palace con ruote antisdrucciolo  
 2 Palace with small wheels  
 2 Palace avec roulettes anti-trace

H 14 cm



# Facile installazione

*Change when you want, will be very easy.*

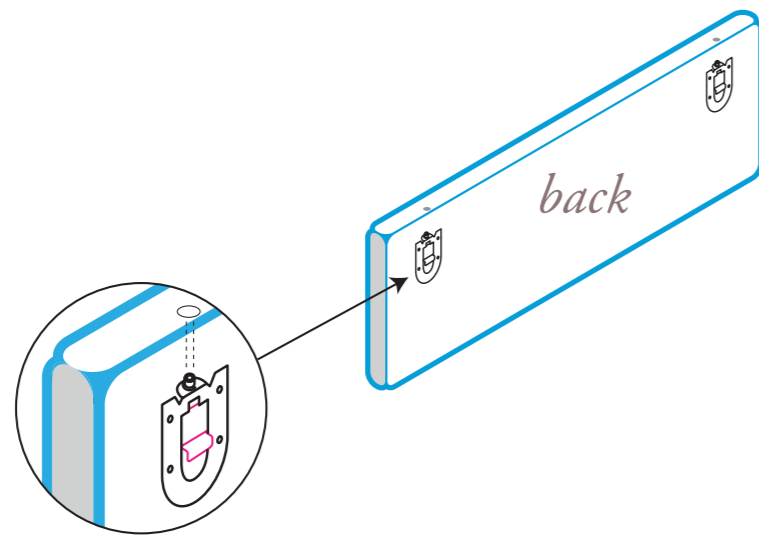

- 1** *I pannelli sono già dotati delle robuste attaccaglie metalliche per l'innesto a baionetta.*  
*The panels are already equipped with sturdy metal brackets for bayonet mount.*  
*Les panneaux sont déjà dotés de fixations métalliques pour fixations à baïonnette.*

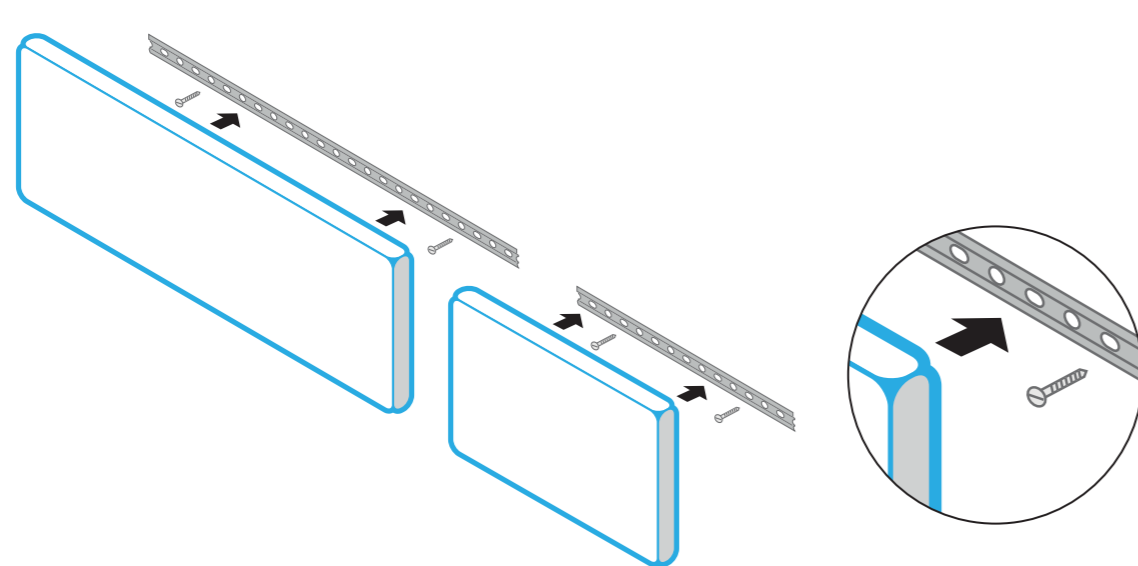

- 2** *Ogni pannello viene fornito con il suo specifico binario di sostegno. Questo consente anche di semplificare poi l'eventuale modifica della composizione o la sostituzione di parte della boiserie.*  
*Each panel comes with its specific support rack.*  
*This also allows to simplify any changes in the composition or the replacement of the wall panels.*  
*Chaque panneau est fourni avec un rail de soutien. Ce qui permet de simplifier l'éventuelle modification de la composition ou le remplacement d'une partie de la boiserie.*

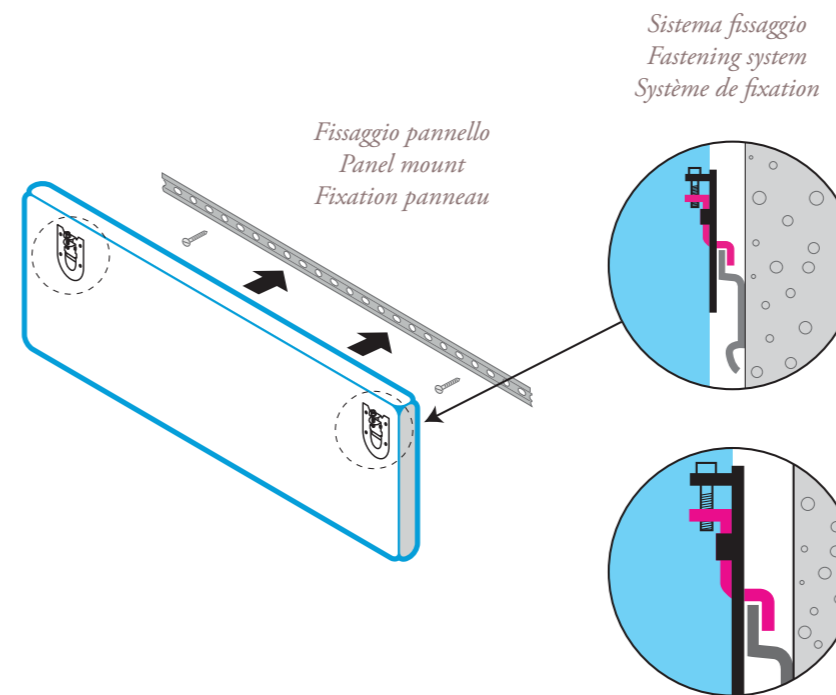

- 3** *L'applicazione dei pannelli a parete sui binari con attacchi a baionetta.*  
*The wall panels are mounted on the rack with bayonet mounts.*  
*Montage des panneaux à la paroi avec rail avec fixations à baïonnette.*

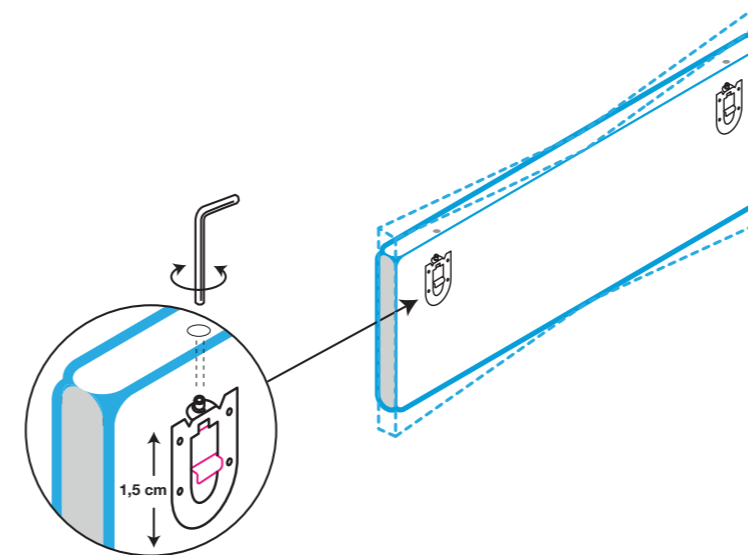

- 4** *Ogni attaccaglia consente una regolazione di 1,5 cm in altezza del pannello per l'allineamento più preciso dell'insieme.*  
*Each bracket allows adjustment of 1.5 cm in height panel for more precise alignment of the module.*  
*Chaque fixation permet un réglage de 1,5 cm en hauteur du panneau pour un alignement plus précis.*

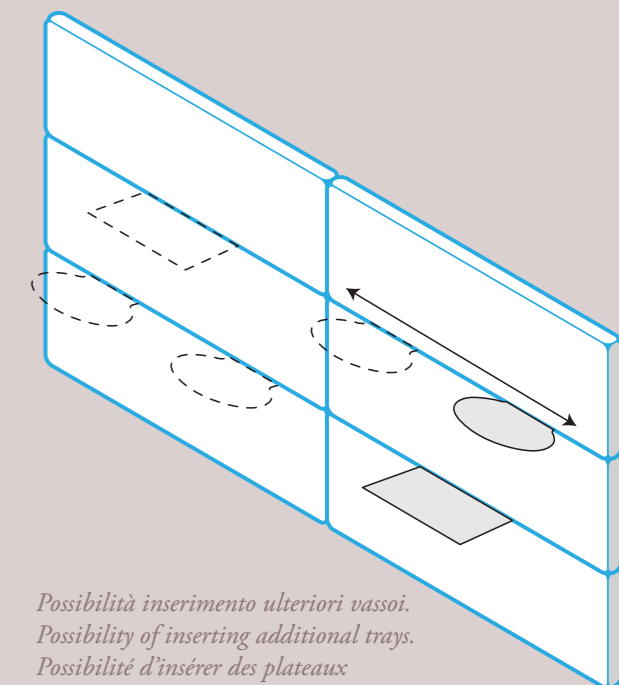
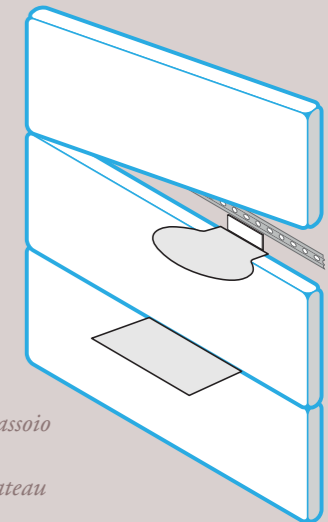

- 5** *I vassoi non richiedono alcun fissaggio e possono sempre essere posizionati ovunque e spostati all'occorrenza con estrema facilità.*  
*The trays do not need to be fixed and can always be positioned anywhere or moved with extreme ease.*  
*Les plateaux n'ont pas besoin de fixation, au contraire ils peuvent être placés partout ou déplacés très facilement en fonction des besoins.*



# Erik

*Un ricco programma di letti singoli*  
*A full program of single beds / Une riche proposition de lits 1 place*





Erik



*e inoltre...  
and also... / et aussi...*

**Houdini**

*Erik è pratico: anche una composizione ad angolo consente l'uso del contenitore salvaspazio e del terzo letto estraibile.*

*Erik is practical: even an angular composition allows a space-saving storage and a third pull-out bed.*

*Erik est pratique: même une composition en angle permet d'avoir un coffre de rangement et un troisième lit extractible.*

# Houdini

*A magic pouf*

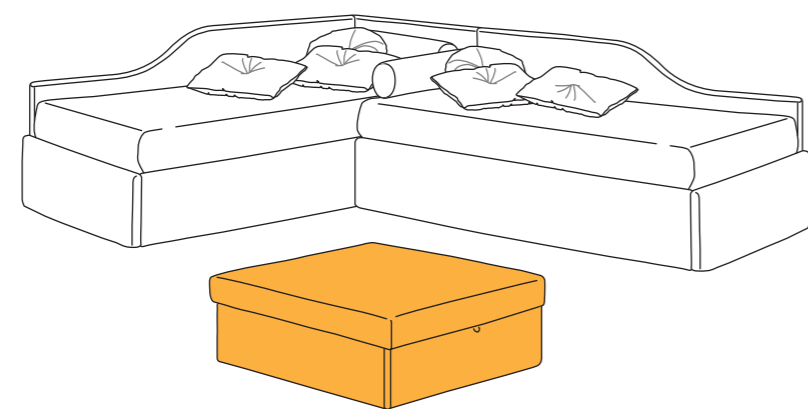

Erik+Houdini

*- Day Solution -*





## Erik+Houdini

- Night Solution -

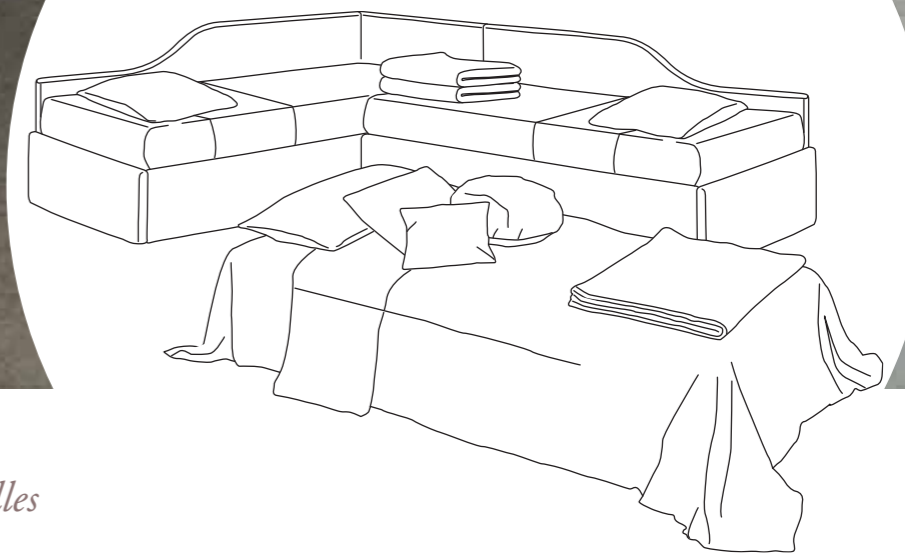

*Per lo sfruttamento ottimale di spazi contenuti... l'abbinamento letti singoli e pouf: belle soluzioni giorno, pratiche soluzioni con uno o due letti in più per la notte.*

*For the optimal exploitation of small spaces.. matching single beds and ottomans, beautiful solutions for the day practical solutions for the night. One or two more beds for the night.*

*Pour optimiser les petits espaces Assortie des lits 1 place et des poufs : de belles solutions de jour et de pratiques solutions de nuit. Un ou deux lits en plus pour la nuit.*

# Houdini

Completamente sfoderabile  
Totally removable cover  
Complètement déhoussable

*Houdini: semplice e veloce*  
*Houdini: simple and fast*  
*Houdini: simple et rapide*

#### Caratteristiche tecniche

**Masselli** in legno di abete e/o scatolati in multistrato di legno di pioppo. **Pannelli** da 18/25 mm in particelle di legno di pioppo in classe E1 a bassa emissione di formaldeide e fibra di legno naturale. **Espansi** di poliuretano indeformabile a portanza differenziata, densità da 18 kg/mc a 40 kg/mc.

**Primo rivestimento** in espanso di poliestere accoppiato a caldo a vellutino aggrappante in poliestere e/o ovatta di poliestere al 100% da 200gr.

**Pouf** dotato di 4 ruote con gomma antiscivolo.

#### Technical characteristics

**Forgings** fir wood, and/or boxed in poplar plywood. **Panels** 18/25 mm in poplar wood particles class E1 low formaldehyde emission and natural wood fiber.

**Polyurethane foam**, crushproof, of different capacity, density from 18 kg/mc to 40 kg/mc.

**First coating** hot bonded polyester foam, velvet adhesion in polyester and/or 100% polyester wool, 200gr.

**Pouf** with four small wheels with anti-slip system.

#### Caractéristiques techniques

**Tige** en pin et/ou boitiers en multicouche en bois de peuplier.

**Panneaux** de 18/25 mm en particules de bois de peuplier classe E1 à faible émission de formaldéhyde et fibre de bois naturelle. **Polyuréthane expansé** indéformable à portée différenciée. densité de 18kg/m<sup>2</sup> à 40kg/m<sup>2</sup>.

**Premier revêtement** en polyester expansé accouplé à chaud à un velours accrochant en polyester et/ou ouate de polyester à 100% de 200g.

**Pouf** avec quatre roulettes avec gomme antiglisce.

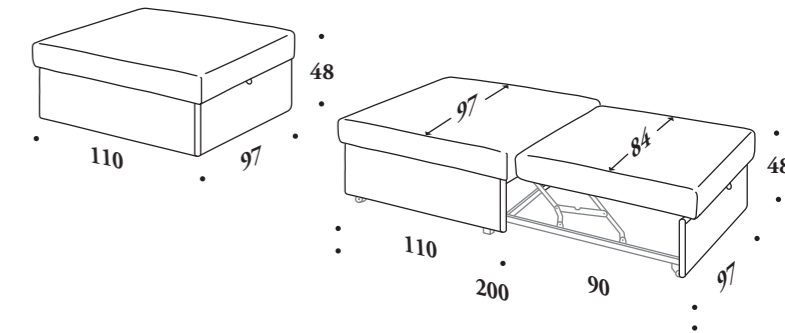

#### **Pouf letto**

*Con il minimo ingombro la possibilità di un posto letto in più. Semplice e veloce.*

*Si estrae frontalmente e si solleva dai lati per ottenere un unico morbido piano letto. Come tutte le proposte Felis completamente sfoderabile.*

#### **Bed ottoman**

*In a small size the possibility of an extra bed.*

*Simple and fast.*

*It is extracted on the front and lifted from the sides to obtain a single soft bed top. Like all proposals by Felis, it is completely removable.*

#### **Pouf lit**

*Avec peu d'encombrement possibilité d'avoir un lit supplémentaire.*

*Simple et rapide.*

*Il s'extrait de face et se soulève par les côtés pour obtenir un lit moelleux. Comme toutes les propositions Felis il est entièrement déhoussable.*

***Le 1000 possibilità del programma letto singolo***

*molto versatile grazie agli ingombri contenuti è utilizzabile per il contract, per il privato, a centrostanza o anche nelle armadiature a ponte o per arredare spazi contenuti.*

***Per l'estetica :*** dal sommier base tutte le possibilità di testiere / fianchi / pediere.

***Per la praticità :*** contenitori con alzata assistita della rete o estraibili.

***Per la funzionalità :*** letto singolo, due singoli, matrimoniale con estrazione automatica o semiautomatica del secondo letto.

***The 1000 possibilities of the single bed program***

*very versatile and compact, suitable for the contract, for private spaces, for the center of the room or even in suspended cupboards or for decorating small spaces.*

***For aesthetics*** from the basic box spring all the possibilities for headboards / sides / footboards.

***For practicality*** containers with assisted lift of the support or removable.

***For functionality*** single bed, double bed, queen bed, with automatic or semi-automatic extraction of the second bed.

***Les 1000 possibilités de lits 1 place***

*très versatile grâce à un faible encombrement utilisable pour l'hôtellerie ou le particulier, au centre de la pièce ou dans des armoires à pont ou pour meubler des espaces exigus.*

***Pour l'esthétisme*** du sommier base toutes les possibilités de tête de lit/côtés/pied de lit

***Pour la commodité*** des coffres de rangement avec soulèvement assisté du sommier ou extractible.

***Pour la fonctionnalité*** lit 1 place, deux lit 1 places, lit 2 places avec extraction deuxième lit automatique ou semi-automatique.



**Erik**



Art. 01

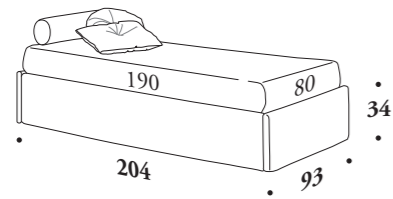

Art. 02

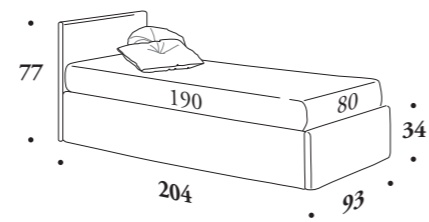

Art. 03

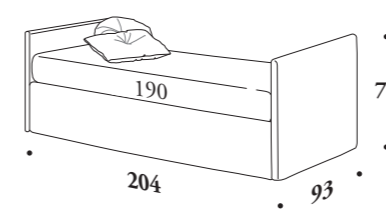

Art. 04

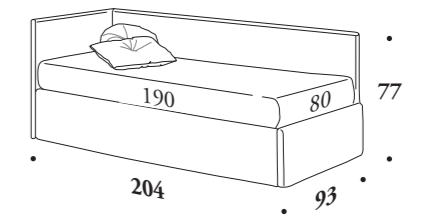

Art. 05

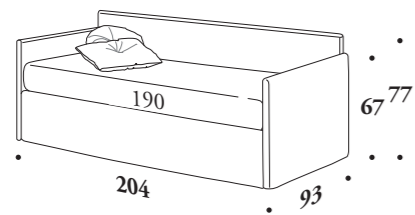

Art. 06

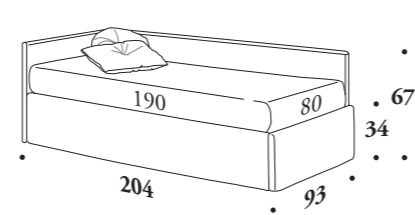

Art. 07

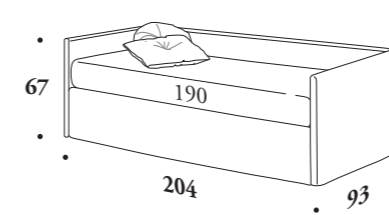

Art. 08 DX

Art. 80 SX

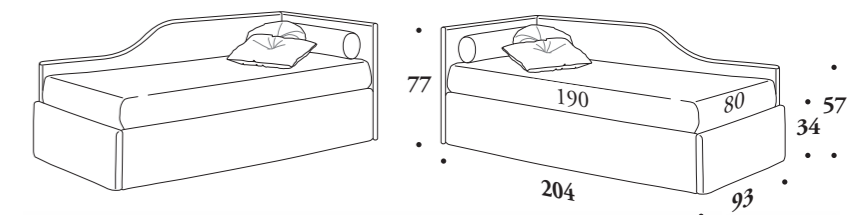

Art. 09

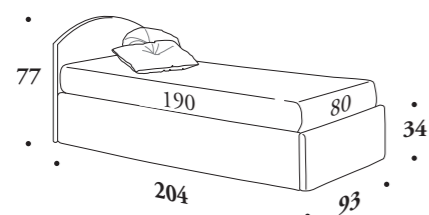

Art. 10

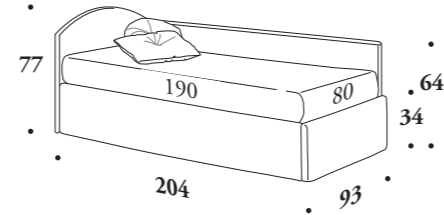

Art. 11

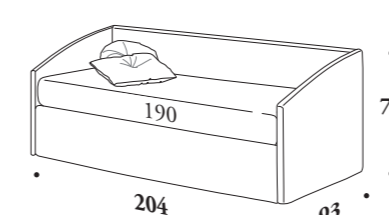

Art. 12 DX

Art. 21 SX

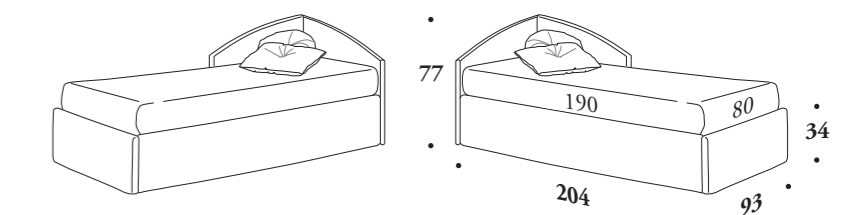



*Contenitore / Storage / Coffre de rangement*



*Cassettone estraibile  
Box storage  
Coffre de rangement à tiroir*



*Contenitore apertura rete  
Support opening storage  
Coffre de rangement ouverture sommier*

*Apertura / Opening / Ouverture*



*Letto supplementare con apertura automatica  
Extra bed with gas-spring assisted opening  
Lit supplémentaire avec ouverture assistée*



*Letto supplementare con apertura semi-automatica  
Extra bed with gas-spring partially assisted opening  
Lit supplémentaire avec ouverture demi-assistée*

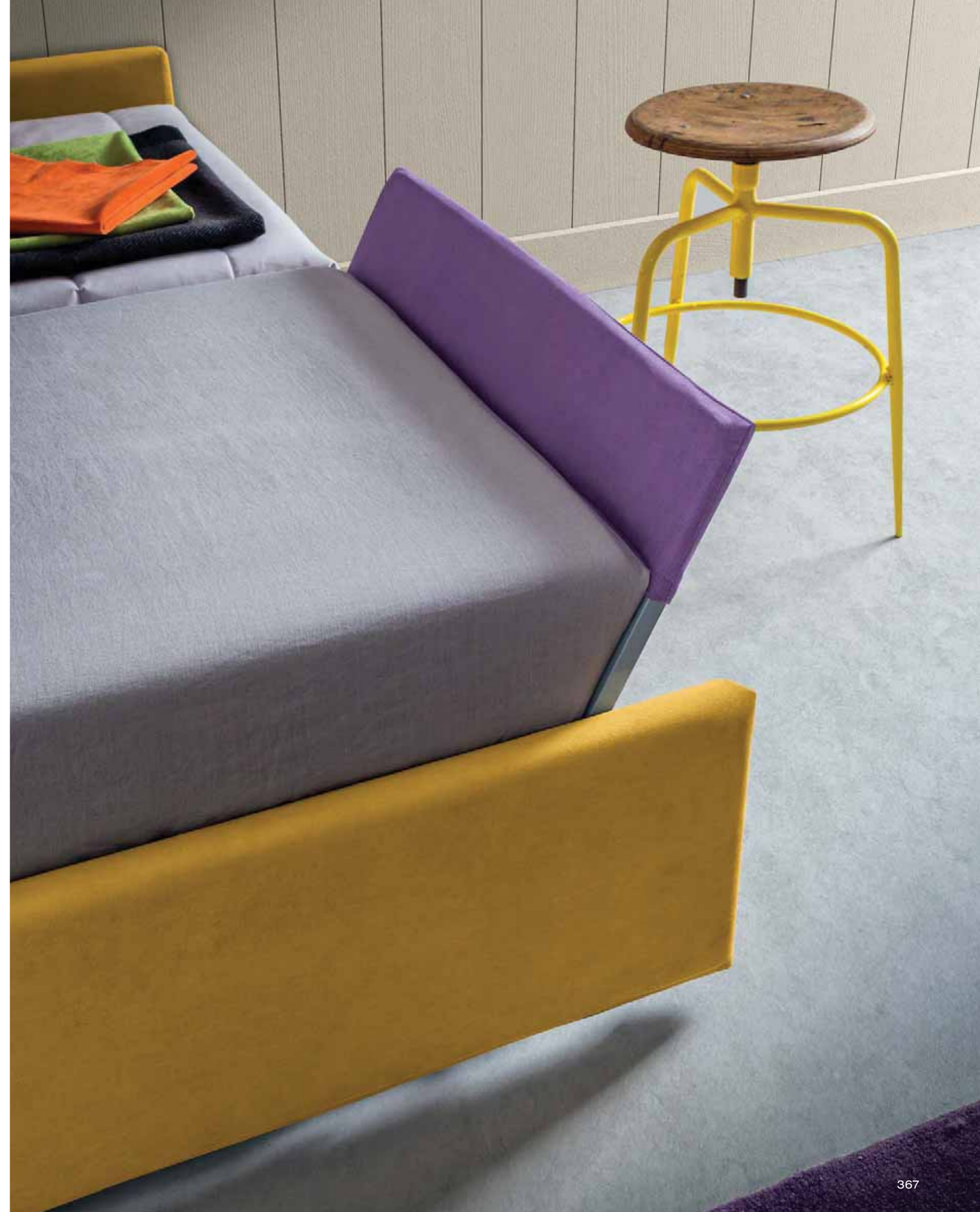

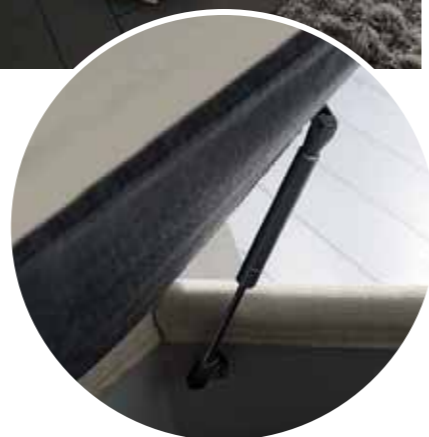

# Pouf

Completamente sfoderabile  
Totally removable cover  
Complètement déhoussable

**Caratteristiche tecniche**  
**Masselli** in legno di abete e/o scatolati in multistrato di legno di pioppo. **Pannelli** da 18/25 mm in particelle di legno di pioppo in classe E1 a bassa emissione di formaldeide e fibra di legno naturale. **Espansi** di poliuretano indeformabile a portanza differenziata, densità da 18 kg/mc a 40 kg/mc.  
**Primo rivestimento** in espanso di poliestere accoppiato a caldo a vellutino aggrappante in poliestere e/o ovatta di poliestere al 100% da 200gr.

**Technical characteristics**  
**Forgings** fir wood, and/or boxed in poplar plywood. **Panels** 18/25 mm in poplar wood particles class E1 low formaldehyde emission and natural wood fiber. **Polyurethane foam**, crushproof, of different capacity, density from 18 kg/mc to 40 kg/mc.  
**First coating** hot bonded polyester foam, velvet adhesion in polyester and/or 100% polyester wool, 200gr.

**Caractéristiques techniques**  
**Tige** en pin et/ou boitiers en multicouche en bois de peuplier. **Panneaux** de 18/25 mm en particules de bois de peuplier classe E1 à faible émission de formaldéhyde et fibre de bois naturelle. **Polyuréthane expansé** indéformable à portée différenciée. densité de 18kg/m<sup>2</sup> à 40kg/m<sup>2</sup>.  
**Premier revêtement** en polyester expansé accouplé à chaud à un velours accrochant en polyester et/ou ouate de polyester à 100% de 200g.

## Pouf contenitore

Art. 01

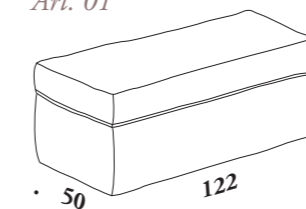

Liscio  
Smooth  
Lisse

Art. 05

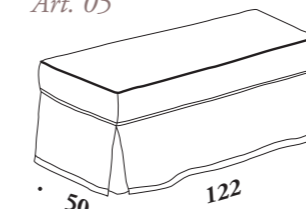

Bordo+ gonna  
Skirt+edge  
Jupe+bord

Art. 02

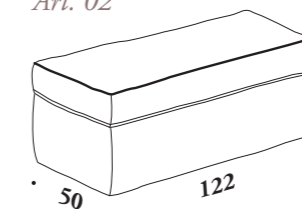

Bordo  
Edge  
Bord

Art. 06

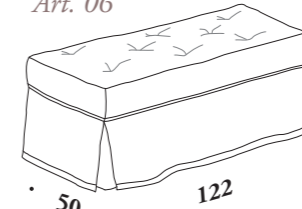

Ripreso+gonna  
Bord+jupe  
Jupe+reprise

Art. 03

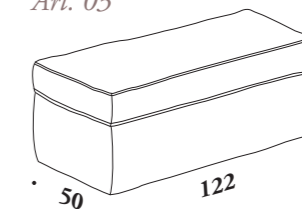

Pizzicato  
Pinched  
Pincé

Art. 04

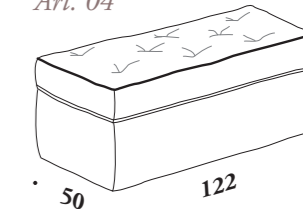

Ripreso+bordo  
Reprised+edge  
Reprise+bord

### Standard

Basic  
H 3 cm



### Varianti colore / Color variants / Couleurs disponibles



### Lux

H 3 cm



### Visual

H 9 cm



### Classic

H 5 cm



# Pouf



# Panquette

Completamente sfoderabile  
Totally removable cover  
Complètement déhoussable

**Caratteristiche tecniche**  
**Masselli** in legno di abete e/o scatolati in multistrato di legno di pioppo. **Pannelli** da 18/25 mm in particelle di legno di pioppo in classe E1 a bassa emissione di formaldeide e fibra di legno naturale. **Espansi** di poliuretano indeformabile a portanza differenziata, densità da 18 kg/mc a 40 kg/mc.  
**Primo rivestimento** in espanso di poliestere accoppiato a caldo a vellutino aggrappante in poliestere e/o ovatta di poliestere al 100% da 200gr.

**Technical characteristics**  
**Forgings** fir wood, and/or boxed in poplar plywood. **Panels** 18/25 mm in poplar wood particles class E1 low formaldehyde emission and natural wood fiber. **Polyurethane foam**, crushproof, of different capacity, density from 18 kg/mc to 40 kg/mc.  
**First coating** hot bonded polyester foam, velvet adhesion in polyester and/or 100% polyester wool, 200gr.

**Caractéristiques techniques**  
**Tige** en pin et/ou boitiers en multicouche en bois de peuplier. **Panneaux** de 18/25 mm en particules de bois de peuplier classe E1 à faible émission de formaldéhyde et fibre de bois naturelle. **Polyuréthane expansé** indéformable à portée différenciée. densité de 18kg/m<sup>2</sup> à 40kg/m<sup>2</sup>.  
**Premier revêtement** en polyester expansé accouplé à chaud à un velours accrochant en polyester et/ou ouate de polyester à 100% de 200g.

Art. 01

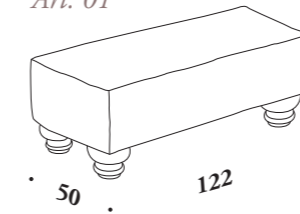

Liscio  
Smooth  
Lisse

Art. 02

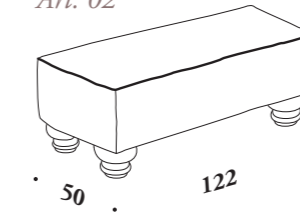

Base+bordo  
Base+edge  
Base+bord

Art. 03

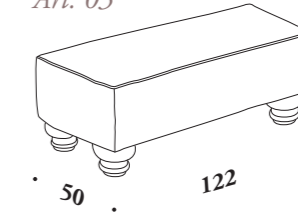

Pizzicato  
Pinched  
Pincé

Art. 04

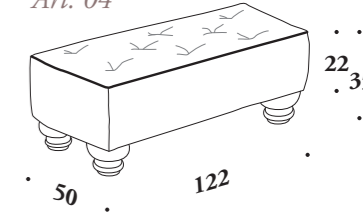

Ripreso+bordo  
Reprised+edge  
Reprise+bord

Standard  
Ghost  
H 13 cm



Optional

	Blade	Blade	Tower	Plexy
H 13 cm	 satinato satin satiné	 bronzato bronze bronze		
Mozart H 13 cm	 wengé / wengé / wengé	 bianco / white / blanc	 argento / silver / argent	 oro / gold / or

# Panquette

**Easy** &  
Change when you want,

**fast**  
it will be very easy.



*Tutti i letti di Felis sono totalmente sfoderabili!*

*Chiunque può procedere facilmente, con semplicità e senza sforzo a togliere e poi a ripristinare il rivestimento della testiera dei cuscini, del giroletto... Per l'igiene l'ordine, la pulizia, perchè il tuo letto Felis deve essere sempre perfetto...*

*All the beds made by Felis are fully removable!*

*All bed programs by Felis are fully removable. Anyone can easily, simply and effortlessly remove and then replace the cover of the headboard of the pillows, the bed frame... For the hygiene, order, cleanliness, because your Felis bed must always be perfect...*

*Tous les lits Felis Sont entièrement déhoussables!*

*Toutes les propositions de lits Felis sont entièrement déhoussables. On peut procéder facilement, simplement et sans effort à enlever, et ensuite à remettre, le revêtement de la tête de lit, des coussins, du tour de lit... Pour l'hygiène, l'ordre et la propreté, parce qu'un lit Felis doit toujours être parfait...*



- Relax System -



- Double face -



- Reversible -



- Multiversion -

*Relax System,  
Double face,  
Reversible,  
Multiversion.*

*Grazie all'innovativa soluzione dei cuscini molte testiere sono relax system, consentono cioè una comoda posizione "seduta" e un pratico appoggio di sostegno per leggere, guardare la tv, lavorare al laptop... Alcune testiere poi, essendo rifinite allo stesso modo davanti e dietro possono essere utilizzate successivamente e indifferentemente dai due lati se vuoi cambiare verso e avere la tua testiera sempre al meglio...*

*Relax System,  
Double face,  
Reversible,  
Multiversion.*

*With the innovative solution of the headboard cushions, many headboards become relaxation systems, that is, allow a comfortable position while "sitting" and a practical support for reading, watching TV, working on laptop... Many headboards... are finished in the same way on the front and back and can be used subsequently on either side, if you want to change direction and have your headboard always at best...*

*Relax System,  
Double face,  
Reversible,  
Multiversion.*

*Grâce à la solution innovante des coussins tête de lit inclinable, de nombreuses tête de lits sont « relax system », elles permettent d'avoir une position assise commode et un appui pratique pour lire, regarder la télé, travailler avec l'ordinateur portable... De nombreuses tête de lit ...ont une finition devant et derrière et peuvent être utilisées des deux côtés pour changer de côté et avoir une tête de lit toujours impeccable...*

## Illuminazione Lighting Éclairage



### **Una soluzione che libera spazio**

*Il punto luce, inglobato nella testiera, discreto ma efficiente perchè proprio lì dove serve. Gli eventuali piani accanto al letto risultano così liberi per altri oggetti o superflui...*

### **A solution that frees up space**

*The light point, incorporated into the headboard, discreet but efficient because it is right there where you need it. Any surfaces by the bed are thus free for other items or unnecessary...*

### **Une solution qui libère l'espace**

*Une lampe incorporée dans la tête de lit discrète mais efficace parce qu'elle se trouve exactement là où il faut. Les surfaces à côté du lit sont libres pour d'autres objets ou sont superflues...*

*Disponibile per i modelli:  
Available for models:  
Disponible pour les modèles:*

Kevin  
Penny



*Le lampade inoltre non richiedono interruttori... per l'accensione utilizza il tecnologico sistema touch, un semplice tocco delle dita direttamente sulla lampada per accendere e spegnere.*

*Moreover, the lamps do not require switches... for ignition, it uses the technological touch system, the touch of your fingers on the lamp turns it on and off.*

*Les lampes n'ont pas besoin d'interrupteurs... pour les allumer il y a la technologie système "tactile", un simple toucher sur la lampe pour allumer et éteindre.*

## Sacca portaoggetti Storage bag Sac porte-objets

### **Portaoggetti in tessuto**

*Per la rivista o il libro, per il tablet o il telefono, per l'astuccio degli occhiali o le cuffie... Un comodo portaoggetti in tessuto coordinato con il rivestimento del letto, una soluzione utile pratica ed elegante.*

### **Fabric storage bag**

*For magazines or books, tablets, or phones, for glass cases or headphones... A handy storage bag in fabric coordinated with the bed cover, a useful, practical, and elegant solution.*

### **Porte-objets en tissu**

*Pour une revue ou un livre, pour la tablette ou le téléphone, pour l'étui à lunettes ou les écouteurs... un porte-objets pratique en tissu assorti au revêtement du lit, une solution utile, pratique et élégante.*

*Disponibile per tutti i modelli  
Available for all models  
Disponible pour tous les modèles*

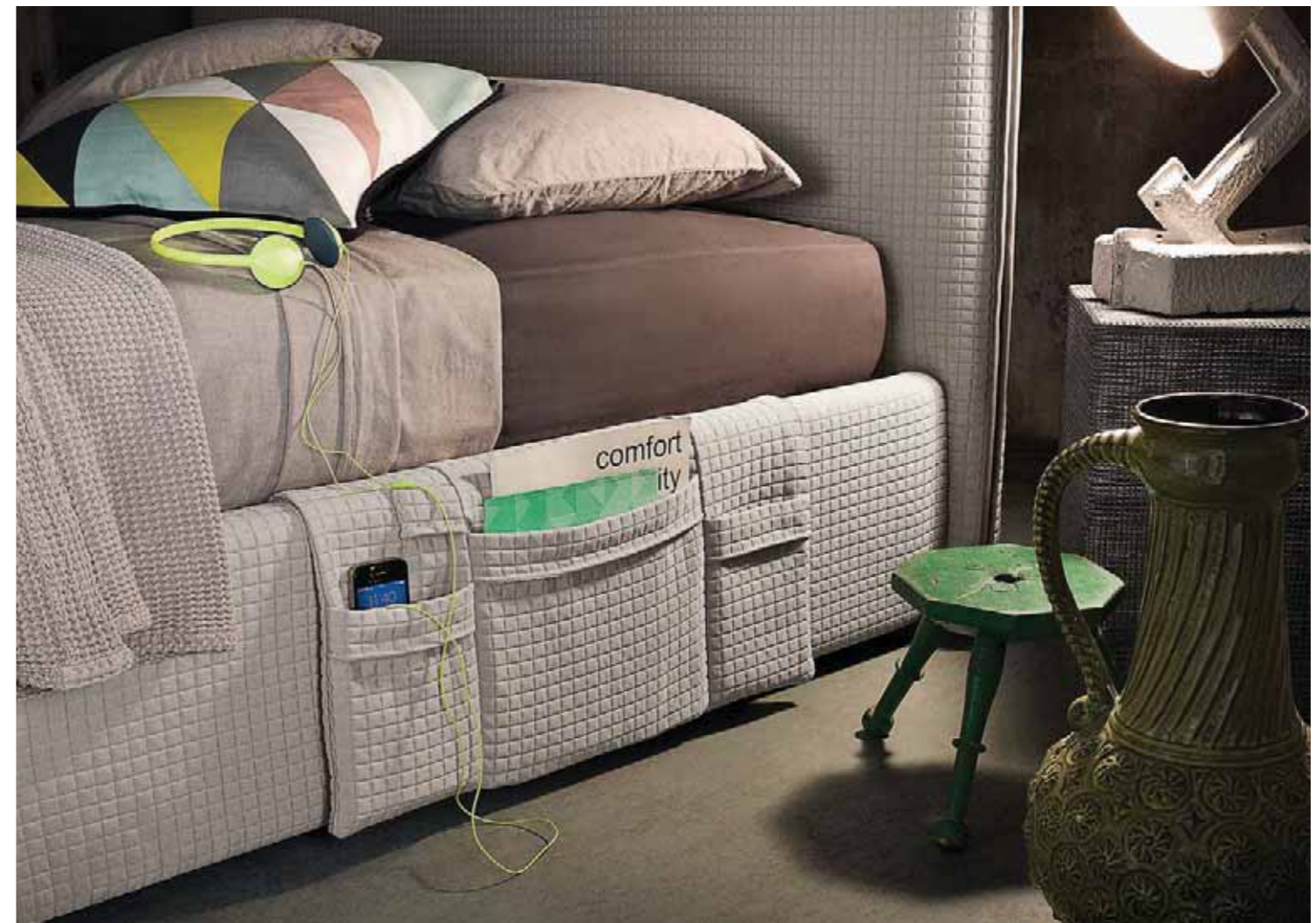

*Tutta la lunghezza, tutto il materasso*  
*All the length, all the mattress*  
*Toute la longueur, tout le matelas*

*Relax System e portagioie*  
*Relax System and jewelry box*  
*Relax System et porte-bijoux*

**Portagioie alla base della testiera**

*Le piccole gioie, il telefono, l'orologio... Tanti piccoli oggetti che non vogliamo con noi durante il sonno possono trovare posto nei pratici portaoggetti ricavati alla base della testiera... Sempre a portata di mano, ma non esposti sul piano dei mobili della camera, riposti in modo più discreto.*

**Jewelry box at the base of the headboard**

*Jewelery, the phone, the watch... So many small items we do not want on us during sleep may find their place in the practical compartments placed at the base of the headboard... Always at hand, but not exposed on the furniture of the room, placed in a more discreet location.*

**Porte-bijoux à la base de la tête de lit**

*Les petits objets, le téléphone, la montre... Tant de petits objets que nous ne voulons pas avec nous pour dormir peuvent trouver leur place dans les porte-objets prévus à la base de la tête de lit... toujours à portée de main, mais non exposés sur les meubles mais rangés de manière discrète.*

*Disponibile per i modelli:*  
*Available for models:*  
*Disponible pour les modèles:*

Allen	Henry
Scotty	Luis
Edgar	Oliver
Emily	Patrick
George	

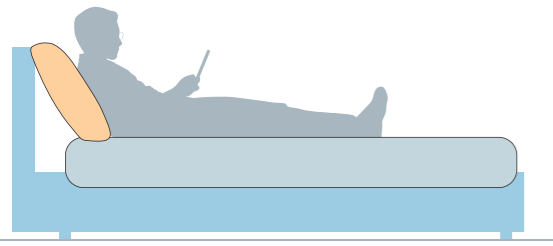
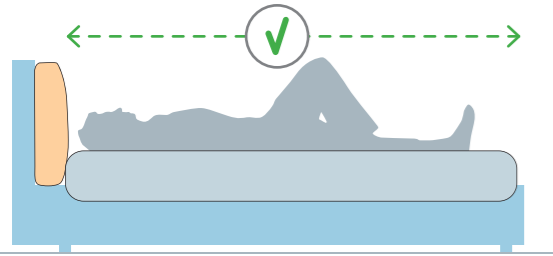

*Nb: le nicchie non rubano spazio al materasso che rimane utilizzabile in tutta la sua lunghezza.*

*Note: the niches do not take mattress space that can still be used throughout its length.*

*Nb: les niches ne volent pas de place au matelas qui peut être utilisé sur toute la longueur.*

*Le comode nicchie poi sono attrezzabili anche con una praticissima torretta caricabatteria per il telefono, il tablet, il personal... Comoda, non ingombrante, esce se serve solo con una leggera pressione e una volta utilizzata scompare.*

*The comfortable niches can then be equipped with a handy turret charger for your phone, tablet, personal computer... Convenient, unobtrusive, it exits, if needed, only by a little pressure and once used it disappears.*

*Les niches peuvent être aménagées avec une tourette pour recharger le téléphone, la tablette, l'ordinateur portable... Pratique et non encombrante elle sort seulement en cas de besoin, une légère pression pour la faire sortir et une fois utilisée elle disparaît.*

*Disponibile per i modelli:*  
*Available for models:*  
*Disponible pour les modèles:*

Allen	Henry
Scotty	Luis
Edgar	Oliver
Emily	Patrick
George	

*USB carica batterie*  
*USB battery charger*  
*USB chargeurs batterie*

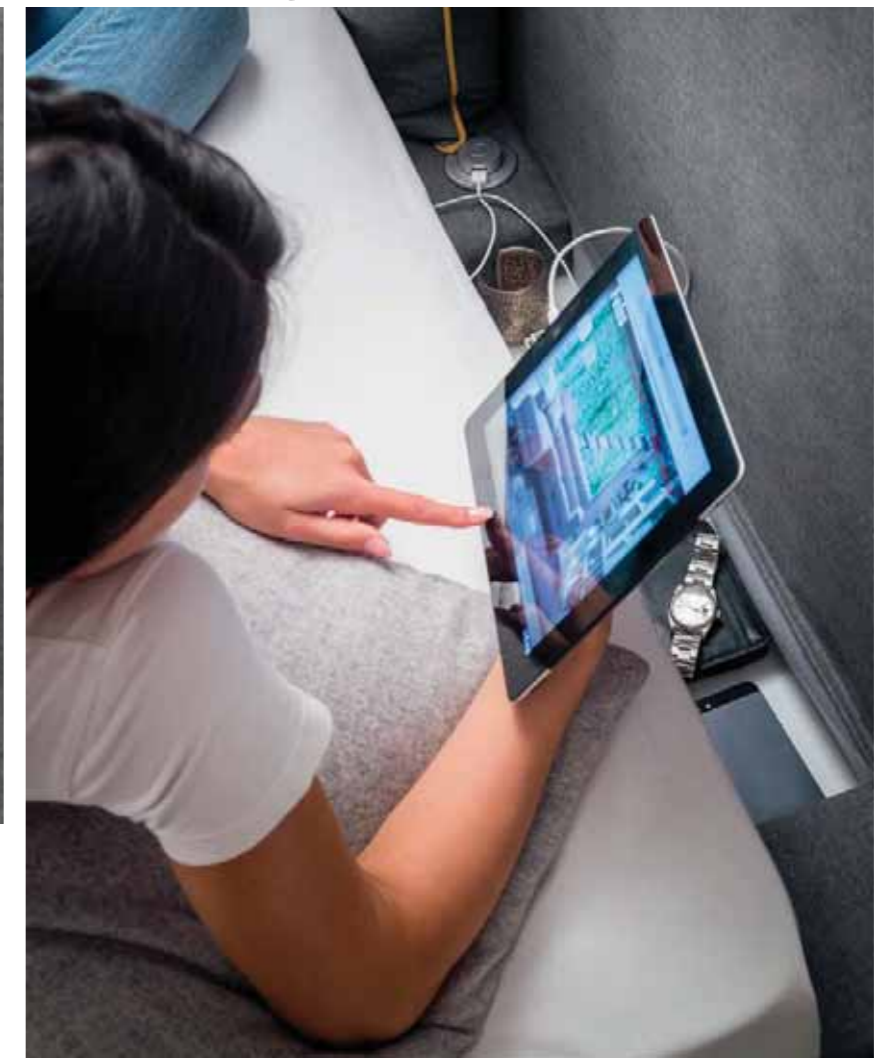

Standard

**Basic wengè**  
H 3 cm



**Lux wengè**  
H 3 cm



**Classic wengè**  
H 5 cm



**Visual wengè**  
H 9 cm



**Basic black**  
H 3 cm



**Lux black**  
H 3 cm



**Classic white**  
H 5 cm



**Visual black**  
H 9 cm



**Basic white**  
H 3 cm



**Lux white**  
H 3 cm



**Classic silver**  
H 5 cm



**Visual white**  
H 9 cm



**Basic silver**  
H 3 cm



**Lux chromo**  
H 3 cm



Polipropilene rigenerato e riciclabile  
Recycled and recyclable polypropylene  
Polypropylène régénéré et recyclé

Piede ad "elle" composto di due pezzi per  
misure complessive cm 18 x 18.  
Faggio naturale stagionato. Verniciatura  
tinta: wengè, nero, bianco opaco e cromato.  
"L" feet composed of two pieces for total size  
18 x 18. Aged natural beech. Paint colors:  
wenge, black, matt white and chrome.  
Pied en "L" composé de deux pièces pour une  
dimension totale de 18cm x 18. Hêtre naturel  
vieilli. Couleurs vernis: wengè, nero, bianco  
opaco e cromato.

Faggio naturale stagionato,  
verniciato con tinte ad acqua.  
Aged natural beech,  
painted with water paint.  
Hêtre naturel vieilli,  
verniss avec vernis à eau.

Polipropilene rigenerato e riciclabile  
Recycled and recyclable polypropylene  
Polypropylène régénéré et recyclé

Standard

**Ghost**  
H 13 cm



Policarbonato trasparente con antiscivolo  
Non-slip transparent polycarbonate  
Polycarbonate transparent et anti-dérapant

**Tower**  
H 13 cm



Acciaio cromato lucido.  
Chrome plated steel.  
Acier chromé brillant.

**Plexy**  
H 13 cm



Plexiglass trasparente con spessore 30mm e gommino antiscivolo.  
Plexiglas with 30mm thickness and non-slip rubber.  
Plexiglas transparent épaisseur 30mm et caoutchouc anti-dérapant.

**Blade bronzato**  
H 13 cm



Lega di alluminio pressofusa. Verniciato con epossidica bronzo con trattamento di spazzolatura.  
Die-cast aluminum. Painted with epoxy bronze brushed.  
Alliage d'aluminium par pressofusion. Vernis époxy bronze brossé.

**Blade satinato**  
H 13 cm



Lega di alluminio pressofusa. Verniciato con epossidica satinato con trattamento di spazzolatura.  
Die-cast aluminum. Painted with epoxy satin brushed.  
Alliage d'aluminium par pressofusion. Vernis époxy satiné brossé.

**Mozart wengè**  
H 13 cm



**Mozart white**  
H 13 cm



**Mozart silver**  
H 13 cm



**Mozart gold**  
H 13 cm



Faggio naturale stagionato,  
verniciato con tinte ad acqua.  
Aged natural beech,  
painted with water paint.  
Hêtre naturel vieilli,  
verniss avec vernis à eau.

## Le reti / Supports / Les sommiers

Le reti sono a struttura metallica con doghe in faggio.

Supports have a metal frame with beech slats.

Les sommiers ont une structure métallique avec lattes en hêtre.

1 - **La rete Armony** è attrezzata con doghe da 68 mm in multistrato di faggio evaporato e curvate a caldo a bassissimo rilascio di formaldeide: 13 doghe per la versione a 1 piazza e 26 doghe per la versione a 2 piazze. Sono solidali alla struttura metallica con attacchi in gomma siliconica. Il Telaio è in acciaio a sezione quadra 40mm x 30mm. Verniciatura con polveri epossidiche.

1 - **The Armony support** is equipped with 68 mm beech plywood slats evaporated and hot curved with very low formaldehyde release: 13 slats for the single bed version and 26 slats for the double bed version. They are integrated with the metal structure with silicone rubber connections. The frame is steel with a 40mm x 30mm square section. Epoxy powder painted.



1 - **Le sommier Armony** a 68 lattes de 68mm en multicouches de hêtre évaporées et recourbées à chaud avec un taux de formaldéhyde très bas: 13 lattes pour la version 1 place et 26 lattes pour la version 2 places. Elles sont montées sur la structure métallique avec des pièces en silicone. Le cadre est en acier à section carrée 40x30mm Vernis epoxy

1. Armony

2 - **La rete Thai** è attrezzata con doghe più numerose e sottili, per adattarsi maggiormente al peso specifico dell'utilizzatore e distribuire in modo uniforme la pressione del materasso. Le doghe sono da 38 mm in legno di faggio: 23 doghe per la versione a 1 piazza e 46 doghe per la versione a 2 piazze. Sono solidali alla struttura metallica grazie ad attacchi in gomma siliconica. Il Telaio è in acciaio a sezione quadra 40mm x 30mm. Verniciatura con polveri epossidiche.

2 - **The Thai support** is equipped with more numerous and thinner slats, to fit better to the specific weight of the user and evenly distribute the pressure of the mattress. The 38 mm slats are made of beech: 13 slats for the single bed version and 26 slats for the double bed version. They are integrated with the metal structure with silicone rubber connections. The frame is steel with a 40mm x 30mm square section. Epoxy powder painted.

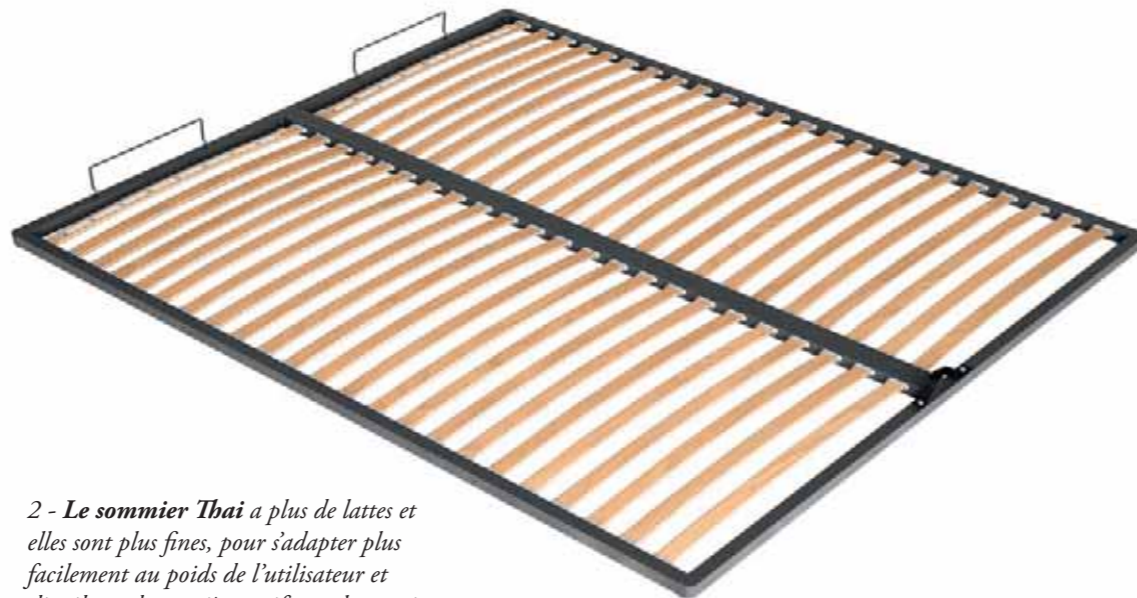

2 - **Le sommier Thai** a plus de lattes et elles sont plus fines, pour s'adapter plus facilement au poids de l'utilisateur et distribuer de manière uniforme la pression du matelas. Les lattes sont de 30mm en hêtre: 23 lattes pour la version 1 place et 46 pour la version 2 places. Elles sont montées sur la structure métallique avec des pièces en silicone. Le cadre est en acier à section carrée 40x30mm Vernis epoxy

2. Thai

3 - **La rete Energy** è dotata di 6/12 doghe in più e relativi regolatori che consentono di variare la rigidità del piano di appoggio, nella zona lombare o dove si preferisce. Agendo sugli appositi regolatori di rigidità nelle zone prescelte e posizionandoli opportunamente è possibile definire esattamente la flessibilità delle diverse zone piano e personalizzare al massimo il sostegno della rete. Le doghe sono da 38 mm in multistrato di faggio evaporato e curvate a caldo a bassissimo rilascio di formaldeide: 23 doghe (+ 6 regolabili) per la versione a 1 piazza e 46 doghe (+ 12 regolabili) per la versione a 2 piazze. Sono solidali alla struttura metallica grazie ad attacchi in gomma siliconica. Il Telaio è in acciaio a sezione quadra 40mm x 30mm. Verniciatura con polveri epossidiche.

3 - **The Energy support** is equipped with 6/12 more slats and corresponding ad frankers that allow to vary the stiffness of the support surface, in the lumbar area or wherever you prefer. By moving the stiffness ad frankers in select areas and placing them appropriately, it is possible to define precisely the flexibility of the different areas and personalize the support. The 38 mm slats are made with beech plywood slats evaporated and hot curved with very low formaldehyde release: 23 slats (+ 6 ad frankeable ones) for the single bed version and 46 slats (+ 12 ad frankeable ones) for the double bed version. They are integrated with the metal structure with silicone rubber connections. The frame is steel with a 40mm x 30mm square section. Epoxy powder painted.

3 - **Le sommier Energy** a 6/12 lattes en plus et des régulateurs qui permettent de varier la rigidité du plan d'appui sur la zone lombaire ou sur d'autres zone. En actionnant les régulateurs de rigidité dans les zones choisies et en les plaçant correctement il est possible de définir exactement la flexibilité des différentes zones et personnaliser au maximum le soutien du sommier. Les lattes de 38 mm en multicouches de hêtre évaporées et recourbées à chaud avec un taux de formaldéhyde très bas: 23 lattes pour la version 1 place (+ 6 réglables) et 46 lattes (+ 12 réglables) pour la version 2 places. Elles sont montées sur la structure métallique avec des pièces en silicone. Le cadre est en acier à section carrée 40x30mm Vernis epoxy.



3. Energy





# Meccanismi Mechanisms Mécanismes

**Il piano-rete si alza facilmente** e senza sforzo grazie ai 2 meccanismi sicuri, brevettati e certificati. E' facile veloce e pratico sollevare il materasso e avere accesso ai capaci contenitori. Il meccanismo tradizionale (A.) collaudato e certificato fino a 5.000 cicli, consente il sollevamento a 45°. Il secondo (B.), sempre servo assistito, consente sia il sollevamento a 45° sia poi di sollevare rete e materasso parallelamente al pavimento all'altezza necessaria (h 1 mt). Sia per avere un accesso più totale ai contenitori che per lavorare più comodamente e rifare il letto senza doversi abbassare in scomode posizioni e sollevare dal basso il materasso.

## A. Dynamic

Meccanica ad "alzata semplice". Telaio in acciaio verniciato a polveri epossidiche e con molle a gas tarate al peso del materasso.

## B. Maverick

Meccanica "a doppia alzata" collaudata fino a 4.000 cicli sia per funzione contenitore che per funzione rifacimento letto. Telaio in acciaio verniciato a polvere epossidiche e con molle a gas tarate al peso del materasso. Telaio in acciaio verniciato a polvere epossidiche e con molle a gas tarate al peso del materasso.



A. Dynamic



B. Maverick



Istruzioni di montaggio  
Assembly instructions  
Instructions de montage

**The support can be lifted** and effortlessly thanks to two safe mechanisms, patented and certified. To lift the whole bed and access the capable containers is easy, fast and convenient. The traditional mechanism (A.) tested and certified up to 5,000 cycles, enables lifting up to 45°. The second (B.), always power assisted, allows both lifting at 45° and lifting of support and bed parallel to the floor up to the necessary height (h 1 m). To have a more complete access to the containers and to work more comfortably and make the bed without having to bend down in awkward positions and lift the mattress from below.

## A. Dynamic

"Simple lift" mechanism. Steel frame coated with epoxy powder paint and with gas springs calibrated to the weight of the mattress.

## B. Maverick

"Double lift" mechanism tested up to 4,000 cycles for both the container function and the bed-making. Steel frame coated with epoxy powder paint and with gas springs calibrated to the weight of the mattress. bed making. Steel frame coated with epoxy powder paint and with gas springs calibrated to the weight of the mattress.

**Le sommier se lève facilement** et sans effort grâce aux deux mécanismes sûrs, brevetés et certifiés. Il est facile et pratique de soulever le lit et accéder au grand coffre de rangement. Le mécanisme traditionnel (A) testé et certifié jusqu'à 5.000 cycles, permet de soulever à 45°. Le deuxième (B), assisté, permet un soulèvement à 45° ou un soulèvement du sommier et du lit parallèle au sol à 1 mètre de haut. Pour avoir un accès total au coffre de rangement et pouvoir faire le lit facilement sans devoir se baisser et soulever le matelas par le bas.

## A. Dynamic

Mécanisme à soulèvement simple Le cadre en acier vernis epoxy et avec ressorts pneumatiques réglés pour le poids du matelas.

## B. Maverick

Mécanisme à double soulèvement testé jusqu'à 4.000 cycles pour la fonction de rangement et la fonction lit relevé. Le cadre en acier vernis epoxy et avec ressorts pneumatiques réglés pour le poids du matelas. refaire le lit. Le cadre en acier vernis epoxy et avec ressorts pneumatiques réglés pour le poids du matelas.



*Coprirete: ordine e pulizia*  
*Support cover: order and cleanliness*  
*Couvre-sommier: ordre et propreté*



**Guaina coprirete** a prova di polvere in tessuto elastico. Crea una ulteriore barriera per proteggere i contenitori dalla polvere e il materasso dallo sfregamento delle doghe. Pratico, sano, efficiente.

**Support cover** dust-proof in stretchy fabric. Creates a further barrier to protect the containers from dust and the mattress from the rubbing of the slats. Practical, healthy, efficient.

**Gaine couvre-sommier** contre la poussière en tissu élastique. Elle crée une ultérieure barrière pour protéger les coffres de rangement de la poussière et le matelas du frottement des lattes. Pratique, sain, efficace.



Disponibile per tutti i modelli  
 Available for all models  
 Disponible pour tous les modèles

*Contentore nel ring*  
*Container inside the ring*  
*Rangement dans le ring*



**I contenitori all'interno del ring** sono chiusi ermeticamente grazie alle spazzole antipolvere applicate sul bordo da 14 mm dei pannelli di fondo che sono dotati di comode maniglie per l'eventuale movimentazione.

**The containers inside the ring** are hermetically closed thanks to the dustproof brushes applied on the edge, 14 mm from the base panels which are equipped with comfortable handles for any movement.

**Les rangements à l'intérieur du tour de lit** sont fermés hermétiquement par des brosses anti-poussière appliquées sur le bord de 14mm des panneaux de fonds qui sont dotés de poignées pour un éventuel déplacement.

per lunghezza / by length / par longueur cm **190**

larghezza / width / largeur cm	90	120	140	160	180
litri / liters / litres	350	460	530	610	680

per lunghezza / by length / par longueur cm **200**

larghezza / width / largeur cm	90	120	140	160	180
litri / liters / litres	360	480	560	640	720

*Sacca contenitore: protezione dalla polvere*  
*Bag container: protection from dust*  
*Sac coffre de rangement: protection contre la poussière*

**Contentore con sacca:** per riporre, proteggere e contenere ordinatamente la tua biancheria, le coperte, i guanciali. Le ampie sacche con la comoda ermetica apertura a cerniera doppia zip, per la più pratica accessibilità, consentono il massimo di igiene e pulizia.

**Container with bag:** to neatly store, protect and contain your underwear, blankets, pillows. The large bags with the convenient hermetic zip opening are a little ingenuity. But a great idea for maximum hygiene and cleanliness.

**Rangement avec sac:** pour ranger, protéger et contenir d'une manière ordonné le linge de maison, les couvertures, les oreillers. Les grands sacs avec une fermeture hermétique à fermeture éclair sont un petit détail. Mais une grande idée pour l'hygiène et le nettoyage.



*Una grande idea: Clean Up System per letti con contenitore*  
*A great idea: Clean Up System for bed with storage*  
*Une grande idée: sistema Clean Up System pour lit avec coffre de rangement*

**Una nuova pratica soluzione per la pulizia sotto il letto, comodamente con swiffer, robotino, aspirapolvere.**

Per sollevare semplicemente il letto di 13 cm senza sforzo è sufficiente alzare due leve a scomparsa, sui lati del ring.

In questo modo si abbassano 4 robuste ruote gommate antitraccia e si alza così tutto il letto che può essere anche spostato avanti e indietro senza sforzo.

Quando le leve si abbassano, le ruote si sollevano e scompaiono e il letto poggia nuovamente sui suoi piedini. Facile, veloce, pratico e sicuro.

**A new practical solution for cleaning under the bed, comfortably with Swiffer, robot vacuum, vacuum cleaner.**

To raise the bed by 13 cm effortlessly, simply raise two retractable levers, on the sides of the ring.

This way, the 4 robust non-marking rubber wheels are lowered back and forth without effort.

When the levers are lowered, the wheels are lifted and disappear and the bed rests on its feet again. Easy, fast, convenient, and safe.

**Une nouvelle solution pour le nettoyage sous le lit, très pratique avec swiffer, robot aspirateur, aspirateur.**

Pour soulever simplement le lit de 13 cm sans effort il suffit de lever les deux leviers sur les côtés du tour de lit.

De cette manière les 4 roues en caoutchouc anti-trace se baissent, le lit se lève et peut être déplacé sans aucun effort.

Quand les leviers se baissent, les roues se soulèvent et disparaissent, le lit repose de nouveau sur ses pieds. Facile, rapide, pratique et sûr.

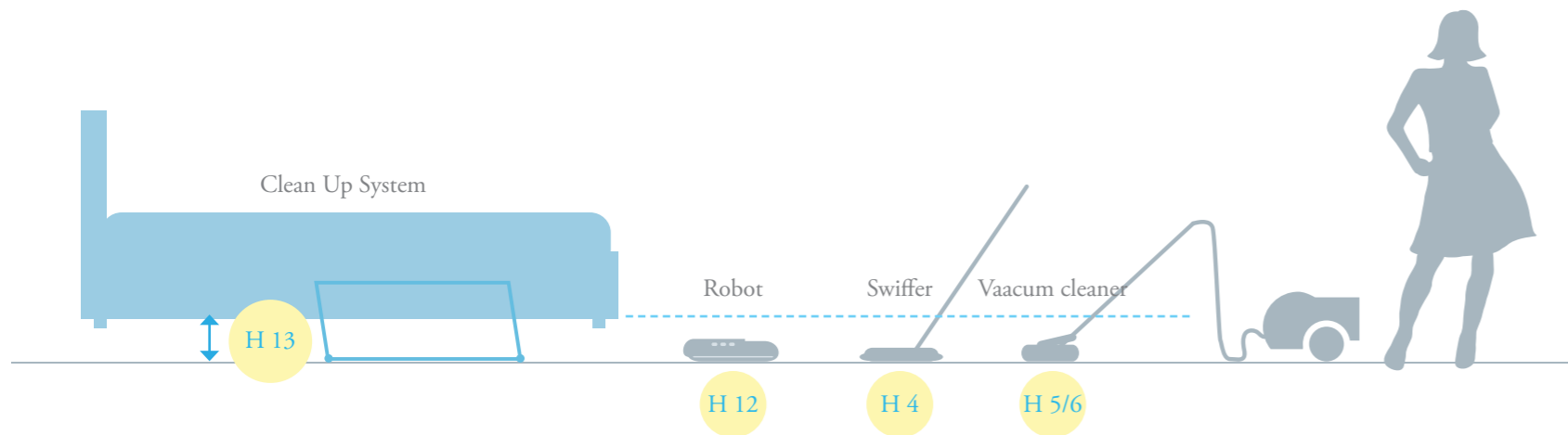

*Sempre l'altezza giusta*  
*Always the right height*  
*Toujours la bonne hauteur*

**Angolare regolabile per sostegno rete**

- Per livellare alla stessa altezza due reti diverse nello stesso letto

- per regolare l'altezza del piano rete con lo spessore del materasso scelto

- o semplicemente per personalizzare e decidere l'altezza del materasso nel proprio letto

Sono disponibili anche supporti angolari che consentono di variare l'altezza a seconda dell'altezza del materasso, del bordo rete o delle preferenze personali.

Disponibili come optional in due versioni su tutti i modelli con rete senza meccanica.

**Ad frankeable angle for the right support**

- To level two different supports at the same height in the same bed

- To ad franke the height of the support with the thickness of the chosen mattress

- Or simply to customize and choose the height of the mattress of the bed

Angle brackets are also available that allow to vary the height depending on the height of the mattress, the edge of the support, or personal preference.

Optionally available in two versions on all models without mechanic system.

**Angle réglable pour soutenir le sommier**

- Pour mettre à niveau la hauteur de deux sommiers différents dans un même lit

- Pour régler la hauteur de la base de sommier avec l'épaisseur du matelas choisie

- ou simplement pour personnaliser et décider la hauteur du matelas dans le lit

Sont aussi disponibles des éléments d'angles qui permettent de varier la hauteur selon la hauteur du matelas, du bord du sommier ou des préférences personnelles.

Disponibles en options en deux versions sur tous les modèles sans mécanique.

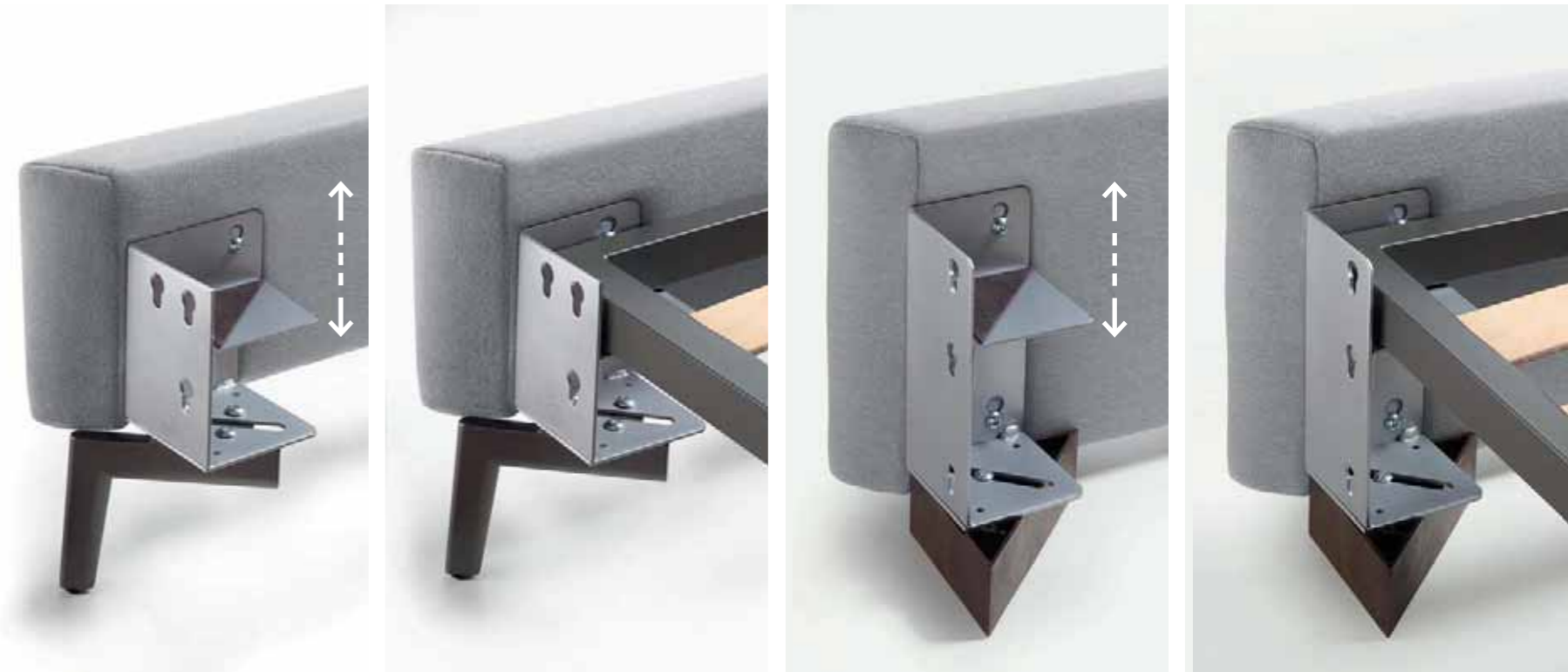
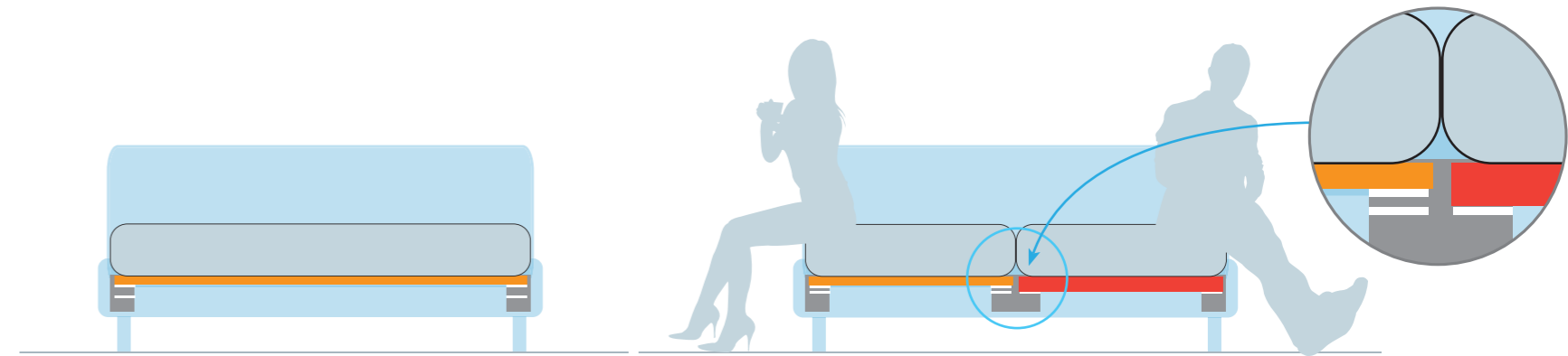

# L'ELEGANTE QUALITÀ ITALIANA

*The elegant italian quality  
L'élégante qualité italienne*



La qualità dell'autentico  
made in italy

### **Solo made in Italy**

Felis produce internamente l'imbottito al 100%:  
una scelta controcorrente, per garantire una qualità  
rigorosamente made in Italy.

### **Solo materiali certificati**

Ogni letto è realizzato in Italia con una grande  
attenzione al dettaglio. Felis impiega solo materiali  
certificati, di prima scelta, all'interno di severe  
procedure produttive.

### **Solo eccellenza**

Felis ti offre un prodotto sicuro e comodo.  
Con un rapporto qualità-prezzo eccellente.

La solidità e il comfort  
dell'eccellenza italiana

### **La nostra storia**

Una tradizione artigianale di 25 anni: Felis realizza  
un gamma molto ampia di letti imbottiti che  
corrispondono a standard rigorosi ed elevati.

### **Tradizione artigianale**

Noi abbiamo un tesoro: la cultura del saper fare, quel  
sapere artigianale che rende ogni nostro prodotto  
esteticamente più bello ma anche più duraturo nel  
tempo.

The quality of authentic  
made in italy

### **Only made in Italy**

Felis produces 100% of the internal padding,  
a choice against the current, to ensure high quality  
made in Italy.

### **Only certified materials**

Every bed is made  
in Italy with great attention to detail.  
Felis utilise uniquement des matériaux certifiés, de  
qualité, avec des procédures de fabrication strictes.

### **Only excellence**

Felis offers a safe and comfortable product.  
With an excellent price-quality ratio

The strength and comfort  
of italian excellence

### **Our story**

A 25 year old artisan tradition: Felis produces a very  
wide range of upholstered beds that meet to strict  
and high standards.

### **Artisan tradition**

We have a treasure: the culture of know-how,  
knowledge, and craftsmanship that helps every  
product look nicer but also be more durable.

La qualité de l'authentique  
made in italy

### **Made in Italy uniquement**

Felis produit l'intégralité du rembourrage de ses meubles:  
un choix à contre-courant permettant de garantir une  
qualité exemplaire strictement Made in Italy.

### **Uniquement matériaux certifiés**

Chaque lit est fabriqué.  
En Italie avec une grande attention aux détails.  
Felis utilise uniquement des matériaux certifiés, de  
qualité, avec des procédures de fabrication strictes.

### **L'excellence uniquement**

Felis vous propose un produit sûr et pratique.  
Avec un excellent rapport qualité-prix

Confort de l'excellence  
Italienne

### **Notre histoire**

Une tradition artisanale depuis 25 ans: Felis fabrique  
une vaste gamme de lits rembourrés aux standards  
rigoureux et élevés.

### **Tradition artisanale**

Nous avons un trésor : la culture du savoir-faire, le  
savoir-faire artisanal qui rend chacun de nos produits  
plus beau mais également plus durable.

Stile e tradizione

### **Il nostro punto di forza**

Il nostro punto di forza sono i tessuti, realizzati in  
collaborazione con le migliori industrie tessili, con  
una particolare attenzione verso i filati, le trame e i  
disegni per poterti offrire una gamma sempre attuale.

La nostra passione  
per i tessuti

### **Il colore è fondamentale**

nella progettazione degli ambienti domestici.  
E si sa, a seconda della personalità, ognuno ha il suo  
colore preferito e le sue idee in fatto di abbinamenti.  
Potrai scegliere tra una palette infinita di colori: dai  
toni più intensi e carichi a quelli naturali, da quelli  
fluo per ambienti creativi e giovanili a quelli classici  
arricchiti da fantasie e decori.

Style and tradition

### **Our strong point**

Our strength lies in the fabrics, made in collaboration  
with the best textile industries, with a particular focus  
on the yarns, textures, and designs, to be able to  
offer an ever present range.

Our passion  
for the fabrics

### **Colours are critical**

in the design of home environments. And, as we  
know, everyone has their own favourite colours and  
their own ideas in terms of combinations, depending  
on their own personality. You can choose between  
an infinite palette of colours: from more intense and  
strong shades, to natural ones; from fluorescent ones  
for creative environments for young people, to classic  
patterns embellished with decorations.

Style et tradition

### **Notre point fort**

Notre force réside dans les tissus, fabriqués en  
collaboration avec les meilleures industries textiles,  
avec une attention particulière pour  
les fils, les textures et les motifs, pour une gamme  
toujours actuelle.

Notre passion  
pour les tissus

### **La couleur est fondamentale**

dans la conception des espaces domestiques.  
Et il est bien connu que, en fonction de notre  
personnalité, nous avons tous notre couleur préférée  
et nos idées de combinaisons. Vous pourrez choisir  
parmi une palette infinie de couleurs : des tons  
les plus intenses et vifs à ceux plus naturels ou  
fluorescents, pour des ambiances créatives et jeunes  
ou classiques et riches de motifs et de décorations.



### **Made in Italy.**

La qualità garantita, che mi rende sicuro.

Tutti i modelli presentati in questo catalogo sono prodotti nella sede dell'azienda in Italia, con materiali certificati, da maestranze qualificate. Le tecnologie costruttive sono di ultima generazione e nei casi in cui la lavorazione manuale si renda indispensabile per un migliore risultato qualitativo essa è impiegata senza riserve. L'Italia vanta una lunga e nobile tradizione nel mondo dell'arredamento e dei mobili imbottiti, che la nostra azienda si pregia di proseguire e tutelare.

### **Made in Italy.**

Guaranteed quality, that makes me feel safe.

All the models presented in this catalogue are manufactured on the company's premises in Italy, with certified materials, by qualified workers. Latest-generation constructional technologies are implemented and, when considered essential for higher-quality results, manual processing is used without reservation. Italy boasts a long and distinguished tradition in the furnishing and upholstered furniture sector, which our company is honoured to continue and safeguard.

### **Made in Italy.**

La qualité garantie, pour une plus grande confiance.

Tous les modèles présentés dans ce catalogue sont produits dans le siège de l'entreprise en Italie, avec des matériaux certifiés, par un personnel qualifié. Les technologies de fabrication sont de dernière génération et si le travail manuel est indispensable pour un meilleur résultat qualitatif, il est utilisé sans réserves. L'Italie a une longue et noble tradition dans le monde de l'ameublement et des meubles rembourrés, que notre entreprise a l'honneur de continuer et de défendre.

AREAnetam.biz

### Utilizzo dei cataloghi e dei campionari.

La proprietà e la gestione di questo catalogo sono della Felis Felix S.r.l.; tutti i materiali presenti al suo interno, compresi testi, immagini ed illustrazioni, nonché i campionari, sono tutelati da copyright posseduti e controllati da Felis Felix S.r.l.

L'utente riconosce e accetta il divieto di copiare, riprodurre, ripubblicare, trasmettere, comunicare, modificare, utilizzare per altri scopi, inviare o distribuire in alcun modo il materiale in questione senza la preventiva autorizzazione scritta della Felis Felix S.r.l.

Eventuali utilizzi non consentiti del materiale in questione costituiscono una violazione dei copyright e dei diritti di proprietà e potranno pertanto essere perseguiti a norma di legge da parte di Felis Felix S.r.l. nei confronti di chiunque ne faccia un uso non corretto.

### Using the catalogues and sample books.

This catalogue is the property of Felis Felix S.r.l., which retains all rights concerning its utilization. All the material contained in the catalogue, including text, photographs and illustrations, as well as the sample books, are protected by copyrights owned and controlled by Felis Felix S.r.l.

The user acknowledges and accepts that it is strictly prohibited to copy, reproduce, re-publish, transmit, communicate, modify, use for different purposes, send or distribute the material in question in any way without the prior written consent of Felis Felix S.r.l.

Any unauthorized utilization of the material in question constitutes a breach of copyright and of the company's intellectual rights. In such event, Felis Felix S.r.l. reserves the right to take the appropriate legal action against whomsoever might use the material in an inappropriate fashion.

### Utilisation des catalogues et de l'échantillonnage.

Felis Felix S.r.l. est le propriétaire de ce catalogue et en assure la gestion; tous les matériaux qui y sont contenus, y compris les textes, les images, les illustrations et les échantillons sont protégés par les droits d'auteur détenus et contrôlés par Felis Felix S.r.l.

L'utilisateur reconnaît et accepte l'interdiction de copier, reproduire, republier, transmettre, communiquer, utiliser pour d'autres finalités, envoyer ou distribuer de quelque façon que ce soit le matériel en question sans l'autorisation préalable et écrite de Felis Felix S.r.l.

D'éventuelles utilisations non autorisées du matériel en question constituent une violation des droits d'auteur et des droits de propriété et, en vertu de la loi, Felis Felix S.r.l. pourra dénoncer quiconque en fait un usage incorrect.

L'azienda si riserva il diritto, in qualsiasi momento e senza preavviso di eliminare gli articoli che riterrà opportuno e/o di apportare tutte le modifiche atte a migliorare il prodotto. Non può inoltre assumersi la responsabilità per eventuali inesattezze del presente catalogo dovute a errori di stampa, trascrizione e traduzione. Tutti i diritti sono riservati.

The company reserves the right to eliminate the items that it deems appropriate, at any time and without notice, and/or to apply any changes deemed necessary to improve the product. Moreover, we shall not take responsibility for any inaccuracies in this catalog due to printing errors, transcription and translation. All rights reserved.

L'entreprise se réserve le droit, à tout moment et sans préavis, de supprimer des articles et/ou d'apporter les modifications nécessaires pour améliorer le produit. De plus, elle n'assumera aucune responsabilité en cas d'inexactitudes constatées dans ce catalogue dues à des erreurs d'impression, de transcription et de traduction. Tous droits réservés.



[www.felis.it](http://www.felis.it)

**Felis**  
SOFT LIVING

Research & Design  
by Felis Lab

FELIS FELIX srl  
Via Mezzomonte, 23  
33077 Sacile (PN) Italy  
tel. +39 0434 737052  
fax +39 0434 737024  
info@felis.it  
[www.felis.it](http://www.felis.it)