



VISUAL COMFORT  
& Co. ♦ Est. 1987



# THE PREMIER SOURCE

Celebrating nearly thirty years, Visual Comfort & Co. has been the industry leader

**for signature designer lighting, collaborating with the most influential names in American design.**

We take great pride in pairing their visions with exquisite craftsmanship and

incomparable finishes. Our commitment is to provide our customers with an extensive selection

of complete lighting solutions: in every style, for every home, and for every project.

# **SIGNATURE DESIGNER LIGHTING**



**E.F. CHAPMAN**



**THOMAS O'BRIEN**



**AERIN LAUDER**



**KELLY WEARSTLER**



**ALEXA HAMPTON**



**BARBARA BARRY**



**SUZANNE KASLER**



**JOHN ROSSELLI**



**ERIC COHLER**



**BARRY GORALNICK**



**IAN K. FOWLER**



**J. RANDALL POWERS**

EXCEPTIONAL PRODUCT



# METICULOUSLY CRAFTED

To fully realize a beautiful design, we believe it must also be skillfully made.

We've developed the finest team of master artisans and craftsmen from around the globe

**to ensure that our lighting is impeccable and lasting down to each detail, every single time.**

Then we create artistic finishes in a constantly growing selection of gorgeous

natural materials, bringing you more decorative options to our broad range of styles.

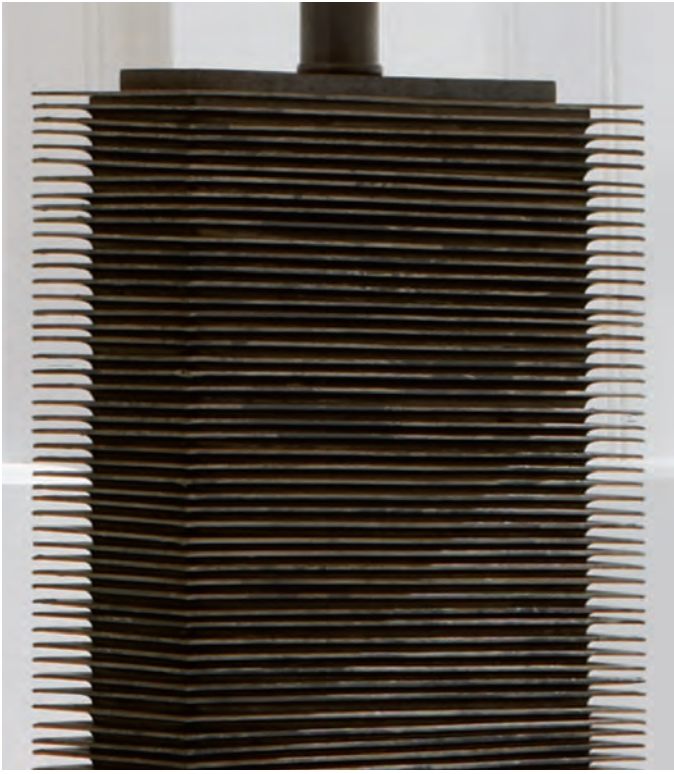

# NATURAL MATERIALS







# ARTISANAL FINISHES



# THE PERFECT STYLE



CASUAL



TRADITIONAL



TRANSITIONAL



MODERN



# FOR EVERY ROOM

Each project is different. From the look you want to the type of light you need,

**it is our goal to have all of the products and profiles that will perfectly complete your space.**

We offer extensive architectural lighting families that can unify rooms seamlessly.

You can also coordinate designs from different collections with the confidence that finishes will always match. Plan all your lighting in one step, or add to your home over time.





# EVERY APPLICATION



**EVERY HOME**





# TABLE OF CONTENTS



## TABLE 20

DECORATIVE 22  
FUNCTIONAL 170



## FLOOR 184

DECORATIVE 186  
FUNCTIONAL 260



**CEILING 282**

- CHANDELIER 284
- HANGING SHADES 414
- PENDANTS 422
- LINEAR 484
- LANTERNS 506
- FLUSH MOUNTS 578



**WALL 632**

- DECORATIVE 634
- FUNCTIONAL 802
- PICTURE 838
- BATH 850



**OUTDOOR 922**

- DECORATIVE 924

# TABLE



DECORATIVE 22  
FUNCTIONAL 170

# DECORATIVE TABLE

**SK3905CG-S**  
**Juliette Table Lamp**  
**in Crystal and Gild**  
**with Silk Shade**

Height: 30"  
Width: 16"  
Base: 8" Square

**Finishes:** CG  
**Shade Treatments:** S  
**Shade Details:**  
14.25" x 16" x 11"

**Socket:** 2 - Pull Chain  
**Wattage:** 2 - 60 A

**Note:** French Wired

**Designer:**  
Suzanne Kasler







**CHA8917CG-NP**  
**Modern Balustrade**  
**Table Lamp in**  
**Crystal with Natural**  
**Paper Shade**  
 Height: 33"  
 Width: 19"  
 Base: 7.5" Square

**Finishes:** CG  
**Shade Treatments:**  
 NP

**Shade Details:**  
 15" x 19" x 12"

**Socket:** Dimmer  
**Wattage:** 150 A

**Note:**  
 French Wired/  
 Cannot be Placed in  
 Direct Sunlight

**Designer:**  
 E. F. Chapman

©EFC DESIGNS



**SL3334CG-NP**  
**Chubby Baluster**  
**Form Table Lamp in**  
**Crystal with Natural**  
**Paper Shade**  
 Height: 27.5"  
 Width: 19"  
 Base: 5" Square

**Finishes:** CG  
**Shade Treatments:**  
 NP

**Shade Details:**  
 15.5" x 19" x 10.5"

**Socket:** Hi-Lo  
**Wattage:** 150 A

**Note:**  
 French Wired/  
 Cannot be Placed in  
 Direct Sunlight

**Designer:**  
 E. F. Chapman

©EFC DESIGNS



**CHA8646CG-NP**  
**Contemporary**  
**Balustrade Table**  
**Lamp in Crystal with**  
**Natural Paper Shade**  
 Height: 30"  
 Width: 16"  
 Base: 5" Square

**Finishes:** ALB, CG  
**Shade Treatments:** NP  
**Shade Details:**  
 14" x 16" x 10.75"

**Socket:** Dimmer  
**Wattage:** 150 A

**Note:** French Wired/  
 Cannot be Placed in  
 Direct Sunlight

**Designer:**  
 E. F. Chapman

©EFC DESIGNS



**CHA8924CG-NP**  
**Balustrade Table**  
**Lamp in Crystal with**  
**Natural Paper Shade**  
 Height: 27"  
 Width: 17"  
 Base: 5.5" Square

**Finishes:** ALB, CG  
**Shade Treatments:**  
 NP, SBP  
**Shade Details:**  
 13" x 17" x 10"

**Socket:** Hi-Lo  
**Wattage:** 150 A

**Note:** French Wired/  
 Cannot be Placed in  
 Direct Sunlight

**Designer:**  
 E. F. Chapman

©EFC DESIGNS



**SL3338CG-S**  
**Square Balustrade**  
**Table Lamp in Crystal**  
**with Silk Shade**  
 Height: 29"  
 Width: 16"  
 Base: 5.25" Square

**Finishes:**  
 AI, CG, GI, OW  
**Shade Treatments:**  
 L, NP, S  
**Shade Details:**  
 11 x 16" x 10"  
 Square

**Socket:** Hi-Lo  
**Wattage:** 150 A

**Note:**  
 French Wired/  
 Crystal Only

**Designer:**  
 E. F. Chapman

©EFC DESIGNS



**CHA8710CG-NP**  
**Gustavian Buffet**  
**Lamp in Crystal with**  
**Natural Paper Shade**  
 Height: 34.25"  
 Width: 14"  
 Base: 5" Square

**Finishes:** BW, CG, GW  
**Shade Treatments:** NP  
**Shade Details:**  
 7" x 14" x 8.5"

**Socket:** Dimmer  
**Wattage:** 60 A

**Note:** French Wired

**Designer:**  
 E. F. Chapman

©EFC DESIGNS



**SL3339CG-NP**  
**Round Medium**  
**Balustrade Table**  
**Lamp in Crystal with**  
**Natural Paper Shade**  
 Height: 29.25"  
 Width: 17"  
 Base: 5.75" Square

**Finishes:**  
 CG, OW  
**Shade Treatments:**  
 NP, SBP  
**Shade Details:**  
 13" x 17" x 10"

**Socket:** Hi-Lo  
**Wattage:** 150 A

**Note:**  
 French Wired/  
 Crystal Only

**Designer:**  
 E. F. Chapman

©EFC DESIGNS



**CHA8926CG-NP**  
**Slender Column Table**  
**Lamp in Crystal with**  
**Natural Paper Shade**  
 Height: 30"  
 Width: 17"  
 Base: 6" Square

**Finishes:** CG  
**Shade Treatments:**  
 NP, SBP  
**Shade Details:**  
 13" x 17" x 10"

**Socket:** Hi-Lo  
**Wattage:** 150 A

**Note:** French Wired

**Designer:**  
 E. F. Chapman

©EFC DESIGNS



**CHA8651CG-NP**  
**Geometric Tall Table Lamp in Crystal with Natural Paper Shade**  
 Height: 31"  
 Width: 17"  
 Base: 4.75" Square

**Finishes:** CG  
**Shade Treatments:** NP  
**Shade Details:**  
 13" x 17" x 10"

**Socket:** Dimmer  
**Wattage:** 150 A

**Note:** French Wired /  
 Cannot be Placed in  
 Direct Sunlight

**Designer:**  
 E. F. Chapman

©EFC DESIGNS



**CHA8993CG-NP**  
**Entarsus Square Obelisk Table Lamp in Crystal with Natural Paper Shade**  
 Height: 30"  
 Width: 14"  
 Base: 5" Square

**Finishes:** AB, CG, PN  
**Shade Treatments:** NP  
**Shade Details:**  
 12.5" x 14" x 9.5"  
 Square

**Socket:** Hi-Lo  
**Wattage:** 150 A

**Note:** French Wired/  
 Cannot be Placed in  
 Direct Sunlight

**Designer:**  
 E. F. Chapman

©EFC DESIGNS



**S3701GI-NP**  
**Wright Table Lamp in Gilded Iron and Glass with Natural Paper Shade**  
 Height: 33"  
 Width: 17"  
 Base: 4.5" x 7.5"  
 Rectangle

**Finishes:** GI, PN  
**Shade Treatments:**  
 NP

**Shade Details:**  
 12.5" x 17" x 10"  
 Rectangle

**Socket:** Hi-Lo  
**Wattage:** 150 A

**Note:** French Wired

**Designer:**  
 Studio VC



**SK3902CG-S**  
**Leigh Table Lamp in Crystal and Gild with Silk Shade**  
 Height: 36.5"  
 Width: 19"  
 Base: 6.5" Square

**Finishes:** CG  
**Shade Treatments:** S  
**Shade Details:**  
 14" x 19" x 11"

**Socket:** Hi-Lo  
**Wattage:** 100 A

**Note:** French Wired /  
 Cannot be Placed in  
 Direct Sunlight

**Designer:**  
 Suzanne Kasler



**CHA8933CG-NP**  
**Oval Stacked Bedside**  
**Lamp in Crystal with**  
**Natural Paper Shade**

Height: 25"  
 Width: 14"  
 Base: 6.5" Oval

**Finishes:** CG  
**Shade Treatments:** NP  
**Shade Details:**  
 12" x 14" x 9" Oval

**Socket:** Hi-Lo  
**Wattage:** 100 A

**Designer:**  
 E. F. Chapman

©EFC DESIGNS



**CHA8934CG-NP**  
**Oval Stacked Table**  
**Lamp in Crystal with**  
**Natural Paper Shade**

Height: 34"  
 Width: 18"  
 Base: 7.75" Oval

**Finishes:** ALB, CG  
**Shade Treatments:** NP  
**Shade Details:**  
 15" x 18" x 12" Oval

**Socket:** Dimmer  
**Wattage:** 150 A

**Designer:**  
 E. F. Chapman

©EFC DESIGNS



**ARN3024CG/PN-L**  
**Lineham Table Lamp**  
**in Crystal and**  
**Polished Nickel with**  
**Linen Shade**

Height: 29.5"  
 Width: 18"  
 Base: 4.5" Round

**Finishes:**  
 ALB, CG/HAB,  
 CG/PN  
**Shade Treatments:** L  
**Shade Details:**  
 18" x 18" x 12.5"

**Socket:** 2 - Keyless  
 with Dimmer  
**Wattage:** 2 - 60 A

**Designer:**  
 AERIN



**ARN3024CG/HAB-L**



**ARN3026CG/PN-L**  
**Olsen Table Lamp**  
 in Crystal and  
 Polished Nickel  
 with Linen Shade  
 Height: 32.5"  
 Width: 17"  
 Base: 5" Octagon

**Finishes:**  
 ALB, CG/HAB, CG/PN  
**Shade Treatments:** L  
**Shade Details:**  
 16" x 17" x 12"

**Socket:** 2 - Keyless  
 with Dimmer  
**Wattage:** 2 - 60 A

**Note:** French Wired

**Designer:**  
 AERIN



ARN3026CG/HAB-L



**AH3050CG/BSL-PL**  
**Lila Table Lamp**  
 in Crystal and Burnished  
 Silver Leaf with  
 Natural Percale Shade  
 Height: 34"  
 Width: 17.25"  
 Base: 7.25" X Shape

**Finishes:**  
 CG/BSL, CG/G  
**Shade Treatments:** PL  
**Shade Details:**  
 9" x 17.25" x 12.75"

**Socket:** Dimmer  
**Wattage:** 100 A

**Designer:**  
 Alexa Hampton



AH3050CG/G-PL



**CHA8906CG-NP**  
**Fluted Spire Large**  
**Table Lamp in**  
**Crystal with Natural**  
**Paper Shade**  
 Height: 31.5"  
 Width: 17"  
 Base: 4.5" Round

**Finishes:**  
 AI, BZV, CG, GI, WHT  
**Shade Treatments:** NP  
**Shade Details:**  
 13" x 17" x 10"

**Socket:** Dimmer  
**Wattage:** 150 A

**Note:** French Wired

**Designer:**  
 E. F. Chapman

©EFC DESIGNS



**CHA8994CG-PL**  
**Russell Modern Tripod**  
**Table Lamp in**  
**Crystal with Natural**  
**Percale Shade**  
 Height: 28.5"  
 Width: 19"  
 Base: 10" Tripod

**Finishes:**  
 AI, BSL, CG, GI  
**Shade Treatments:**  
 NP, PL  
**Shade Details:**  
 15.5" x 19" x 10.5"

**Socket:** Dimmer  
**Wattage:** 150 A

**Note:** French Wired

**Designer:**  
 E. F. Chapman

©EFC DESIGNS



**CHA8950CG-NP**  
**Octagonal Spire**  
**Medium Table Lamp in**  
**Crystal with Natural**  
**Paper Shade**  
 Height: 25"  
 Width: 13.5"  
 Base: 3.5" Octagon

**Finishes:** CG  
**Shade Treatments:** NP  
**Shade Details:**  
 11" x 13.5" x 9"

**Socket:** Dimmer  
**Wattage:** 150 A

**Note:** French Wired

**Designer:**  
 E. F. Chapman

©EFC DESIGNS



**CHA8951CG-NP**  
**Octagonal Spire**  
**Large Table Lamp in**  
**Crystal with Natural**  
**Paper Shade**  
 Height: 31.5"  
 Width: 17"  
 Base: 4.5" Octagon

**Finishes:** CG  
**Shade Treatments:** NP  
**Shade Details:**  
 13" x 17" x 10"

**Socket:** Dimmer  
**Wattage:** 150 A

**Note:** French Wired

**Designer:**  
 E. F. Chapman

©EFC DESIGNS



**CHA8988CG-NP**  
**Veneto Tripod Lamp**  
in Crystal with  
Natural Paper Shade  
Height: 28.75"  
Width: 17"  
Base: 10" Tripod

**Finishes:** CG  
**Shade Treatments:** NP  
**Shade Details:**  
13" x 17" x 10"

**Socket:** Hi-Lo  
**Wattage:** 100 A

**Note:** French Wired

**Designer:**  
E. F. Chapman

©EFC DESIGNS



**TOB3096CG-NP**  
**Tina Buffet Lamp in**  
**Crystal with Natural**  
**Paper Shade**

Height: 41"  
 Width: 13"  
 Base: 6" Triangle

**Finishes:** ALB, CG  
**Shade Treatments:** NP  
**Shade Details:**  
 11" x 13" x 14"

**Socket:**  
 2 - Pull Chain  
**Wattage:** 2 - 60 A

**Note:** French Wired

**Designer:**  
 Thomas O'Brien



**TOB3094CG-NP**  
**Tina Table Lamp in**  
**Crystal with Natural**  
**Paper Shade**

Height: 23.75"  
 Width: 11"  
 Base: 8" Triangle

**Finishes:** ALB, CG  
**Shade Treatments:** NP  
**Shade Details:**  
 10" x 11" x 11"

**Socket:** Dimmer  
**Wattage:** 75 A

**Note:** French Wired

**Designer:**  
 Thomas O'Brien



**TOB3095CG-NP**  
**Tina Table Lamp in**  
**Crystal with Natural**  
**Paper Shade**

Height: 34.5"  
 Width: 13"  
 Base: 8" Triangle

**Finishes:** ALB, CG  
**Shade Treatments:** NP  
**Shade Details:**  
 12" x 13" x 14"

**Socket:**  
 2 - Pull Chain  
**Wattage:** 2 - 60 A

**Note:** French Wired

**Designer:**  
 Thomas O'Brien





**SK3918CG-S**  
**Olivia Table Lamp**  
 in Crystal with  
 Silk Shade

Height: 21.25"  
 Width: 12"  
 Base: 7" Round

**Finishes:** CG  
**Shade Treatments:** S  
**Shade Details:**  
 10" x 12" x 7.5"

**Socket:** On - Off  
**Wattage:** 100 A

**Note:** French Wired

**Designer:**  
 Suzanne Kasler



**TOB3755CG-PL**  
**Talon Table Lamp**  
 in Crystal with  
 Natural Percale

Height: 20.75"  
 Width: 10"  
 Base: 3" Round

**Finishes:** CG  
**Shade Treatments:** PL  
**Shade Details:**  
 7" x 10" x 10"

**Socket:** On - Off  
**Wattage:** 75 A

**Note:** French Wired

**Designer:**  
 Thomas O'Brien



**TOB3757CG-NP**  
**Dasha Table Lamp**  
 in Crystal with  
 Natural Paper Shade

Height: 22"  
 Width: 9.25"  
 Base: 4.5" Square

**Finishes:** CG  
**Shade Treatments:** NP  
**Shade Details:**  
 8.5" x 9.25" x 9.25"  
 Oval

**Socket:** On - Off  
**Wattage:** 75 A

**Designer:**  
 Thomas O'Brien



**ARN3100CG-L**  
**Cannes Table Lamp**  
**in Clear Glass**  
**with Linen Shade**  
Height: 31"  
Width: 17"  
Base: 8.25" Sculptural

**Finishes:**

BSL, CG, G

**Shade Treatments: L**

**Shade Details:**

17" x 17" x 12.5"

**Socket:** Dimmer

**Wattage:** 150 A

**Note:** French Wired

**Designer:**

AERIN



**CHA8909CG-NP**  
**Westport Table Lamp**  
 in Crystal with Natural  
 Paper Shade  
 Height: 28.25"  
 Width: 17"  
 Base: 5.5" Round

**Finishes:** CG  
**Shade Treatments:** NP  
**Shade Details:**  
 13" x 17" x 10"

**Socket:** Dimmer  
**Wattage:** 150 A

**Note:** French Wired

**Designer:**  
 E. F. Chapman

©EFC DESIGNS



**TOB3709CG-PL**  
**Oleta Large Table**  
 Lamp in Crystal and  
 Polished Nickel with  
 Natural Percale Shade  
 Height: 28"  
 Width: 15"  
 Base: 6.75" Round

**Finishes:** CG  
**Shade Treatments:** PL  
**Shade Details:**  
 9" x 15" x 12"

**Socket:** 2 - Pull Chain  
**Wattage:** 2 - 60 A

**Designer:**  
 Thomas O'Brien



**SK3900CG-S**  
**Chloe Table Lamp**  
 in Clear Crystal  
 with Silk Shade  
 Height: 21.25"  
 Width: 12"  
 Base: 4.5" Round

**Finishes:** CG  
**Shade Treatments:** S  
**Shade Details:**  
 10" x 12" x 7.5"

**Socket:** Dimmer  
**Wattage:** 100 A

**Note:** French Wired

**Designer:**  
 Suzanne Kasler



**SK3901CG-S**  
**Chloe Tall Table**  
 Lamp in Clear Crystal  
 with Silk Shade  
 Height: 29"  
 Width: 17"  
 Base: 6" Round

**Finishes:** CG  
**Shade Treatments:** S  
**Shade Details:**  
 13" x 17" x 10"

**Socket:** Dimmer  
**Wattage:** 100 A

**Note:** French Wired

**Designer:**  
 Suzanne Kasler



**TOB3051CG-NP**  
**Terri Tiny Round**  
**Accent Lamp in**  
**Crystal with Natural**  
**Paper Shade**  
 Height: 10.25"  
 Width: 5"  
 Base: 2.25" Round

**Finishes:**  
 BZ, CG, HAB, PN  
**Shade Treatments:** NP  
**Shade Details:**  
 3" x 5" x 5.5"

**Socket:** Candelabra  
 with Hi-Lo Line Switch  
**Wattage:** 40 B

**Note:** French Wired/  
 Cannot be Placed in  
 Direct Sunlight

**Designer:**  
 Thomas O'Brien



**TOB3014CG-NP**  
**Terri Round Accent**  
**Lamp in Crystal with**  
**Natural Paper Shade**  
 Height: 12.5"  
 Width: 6"  
 Base: 3" Round

**Finishes:** CG  
**Shade Treatments:** NP  
**Shade Details:**  
 4" x 6" x 6"

**Socket:** Hi-Lo  
**Wattage:** 60 A

**Note:** French Wired/  
 Cannot be Placed in  
 Direct Sunlight

**Designer:**  
 Thomas O'Brien



**TOB3023CG-NP**  
**Terri Large Round**  
**Table Lamp in**  
**Crystal with Natural**  
**Paper Shade**  
 Height: 15"  
 Width: 8"  
 Base: 3" Round

**Finishes:** ALB, CG  
**Shade Treatments:** NP  
**Shade Details:**  
 5" x 8" x 8"

**Socket:** Hi-Lo  
**Wattage:** 75 A

**Note:** French Wired/  
 Cannot be Placed in  
 Direct Sunlight

**Designer:**  
 Thomas O'Brien



**TOB3378CG/BSL-PL**  
**Bebe Table Lamp in**  
**Crystal and Burnished**  
**Silver Leaf with**  
**Natural Percalé Shade**  
 Height: 27"  
 Width: 14"  
 Base: 5.75" Round

**Finishes:**  
 CG/BSL, CG/G,  
 CG/PN  
**Shade Treatments:** PL  
**Shade Details:**  
 8" x 14" x 11.25"

**Socket:** 2 - Pull Chain  
**Wattage:** 2 - 40 A

**Designer:**  
 Thomas O'Brien



**TOB3378CG/G-PL**



**ARN3000CG-L**  
**Morton Table Lamp**  
**in Clear Glass**  
**with Linen Shade**  
Height: 24.5"  
Width: 16.5"  
Base: 4.5" Round

**Finishes:** BSL, CG, G  
**Shade Treatments:** L  
**Shade Details:**  
10" x 16.5" x 12"

**Socket:** Dimmer  
**Wattage:** 100 A

**Designer:**  
AERIN





**CHA8983AB-NP**  
**Crystal Panel Table Lamp in Antique-Burnished Brass with Natural Paper Shade**  
 Height: 29.5"  
 Width: 16"  
 Base: 4.75" x 9.75"  
 Rectangle

**Finishes:** AB, SN  
**Shade Treatments:** NP  
**Shade Details:**  
 15" x 16" x 12"  
 Rectangle

**Socket:** Dimmer  
**Wattage:** 150 A

**Note:** French Wired

**Designer:**  
 E. F. Chapman

©EFC DESIGNS



**CHA8983SN-NP**



**TOB3031CG-C**  
**Block Table Lamp in Crystal and Polished Silver with Cotton Shade**  
 Height: 18" - 19.5"  
 Width: 11.5"  
 Base: 4" x 6"  
 Rectangle

**Finishes:** CG  
**Shade Treatments:** C  
**Shade Details:**  
 11.5" x 11.5" x 8"

**Socket:** 2 - Pull Chain  
**Wattage:** 2 - 40 B

**Designer:**  
 Thomas O'Brien



**TOB3030CG-C**  
**Block Large Table Lamp in Crystal and Polished Silver with Cotton Shade**  
 Height: 24" - 26"  
 Width: 16.75"  
 Base: 6" x 9"  
 Rectangle

**Finishes:** CG  
**Shade Treatments:** C  
**Shade Details:**  
 15" x 16.75" x 10.5"  
 Oval

**Socket:** 2 - Pull Chain  
**Wattage:** 2 - 60 A

**Designer:**  
 Thomas O'Brien



**TOB3027SG-NP**  
**Miro Table Lamp in**  
**Seeded Glass with**  
**Natural Paper Shade**  
Height: 32" - 34"  
Width: 20"  
Base: 8.5" Square

**Finishes:** SG  
**Shade Treatments:** NP  
**Shade Details:**  
12" x 20" x 15.5"

**Socket:** 2 - Pull Chain  
**Wattage:** 2 - 75 A

**Designer:**  
Thomas O'Brien





**TOB3129WG-NP**  
**Fiona Small Table**  
**Lamp in White**  
**Glass with Natural**  
**Paper Shade**  
Height: 29.5"  
Width: 11"  
Base: 4.5" Square

**Finishes:** MG, WG  
**Shade Treatments:** NP  
**Shade Details:**  
11" x 11" x 12.75"

**Socket:** Dimmer  
**Wattage:** 150 A

**Designer:**  
Thomas O'Brien

TOB3129MG-NP



**TOB3029WG-NP**  
**Fiona Large Table**  
**Lamp in White**  
**Glass with Natural**  
**Paper Shade**  
Height: 44.25"  
Width: 15"  
Base: 5.75" Square

**Finishes:** MG, WG  
**Shade Treatments:** NP  
**Shade Details:**  
15" x 15" x 18.75"

**Socket:** Dimmer  
**Wattage:** 150 A

**Designer:**  
Thomas O'Brien

TOB3029MG-NP



**SL3811MG-NP**  
**Open Bottom Gourd**  
**Table Lamp in**  
**Mercury Glass with**  
**Natural Paper Shade**  
 Height: 30"  
 Width: 19"  
 Base: 6" Round

**Finishes:**  
 CG, MG, WG  
**Shade Treatments:**  
 NP  
**Shade Details:**  
 15" x 19" x 12"  
**Socket:** Hi-Lo  
**Wattage:** 150 A

**Designer:**  
 E. F. Chapman

©EFC DESIGNS



**SL3811WG-NP**



**SL3845MG-NP**  
**Bull Nose Cylinder**  
**Table Lamp in Mercury**  
**Glass with Natural**  
**Paper Shade**  
 Height: 32"  
 Width: 19"  
 Base: 9.5" Round

**Finishes:** MG  
**Shade Treatments:**  
 NP  
**Shade Details:**  
 14" x 19" x 13"  
**Socket:** Dimmer  
**Wattage:** 150 A

**Designer:**  
 E. F. Chapman

©EFC DESIGNS



**CHA8653MG-NP**  
**Hurricane Form Table**  
**Lamp in Mercury**  
**Glass with Natural**  
**Paper Shade**  
 Height: 37"  
 Width: 23"  
 Base: 13" Round

**Finishes:** MG  
**Shade Treatments:**  
 NP  
**Shade Details:**  
 18" x 23" x 14"  
**Socket:** Dimmer  
**Wattage:** 150 A

**Designer:**  
 E. F. Chapman

©EFC DESIGNS



NW3001AM-S  
Augusta Table Lamp  
in Antique Mirror  
with Silk Shade  
Height: 24.5"  
Width: 12.25"  
Base: 6" Square

Finishes: AM  
Shade Treatments: S  
Shade Details:  
12.25" x 12.25" x 9"

Socket: Dimmer  
Wattage: 100 A

Designer:  
Niermann Weeks





**BBL3006WG-S**  
**Moon Glow Table**  
**Lamp in White Glass**  
**with Silk Shade**  
 Height: 28.5"  
 Width: 17"  
 Base: 6.5" Round

**Finishes:** WG  
**Shade Treatments:** S  
**Shade Details:**  
 16" x 17" x 14"

**Socket:** Dimmer  
**Wattage:** 150 A

**Note:** Inside Light  
 40 A On-Off

**Designer:**  
 Barbara Barry



**BBL3009CG-S**  
**Simple Cylinder Table**  
**Lamp in Clear Glass**  
**with Silk Shade**  
 Height: 28"  
 Width: 19.5"  
 Base: 10.25" Round

**Finishes:** CG  
**Shade Treatments:**  
 S  
**Shade Details:**  
 18" x 19.5" x 13"

**Socket:** Dimmer  
**Wattage:** 150 A

**Note:** French Wired

**Designer:**  
 Barbara Barry



**SP3015GI/CG-NP**  
**Brooks Table Lamp**  
**in Crystal and**  
**Gilded Iron with**  
**Natural Paper Shade**  
 Height: 30"  
 Width: 23"  
 Base: 8.75" Round

**Finishes:** AI, GI, PN  
**Shade Treatments:** NP  
**Shade Details:**  
 5" x 23" x 14"

**Socket:** Hi-Lo  
**Wattage:** 100 A

**Note:**  
 French Wired

**Designer:**  
 J. Randall Powers



**SP3015AI/CG-NP**



**CHA8655ICO-NP**  
Orson Balustrade  
Form Table in  
Coconut with  
Natural Paper Shade  
Height: 32.5"  
Width: 17"  
Base: 6" Round

**Finishes:**  
DM, ICO,  
OSB, SHB, SHK  
**Shade Treatments:** NP  
**Shade Details:**  
16" x 17" x 12"

**Socket:** Dimmer  
**Wattage:** 150 A

**Designer:**  
E. F. Chapman

©EFC DESIGNS



**CHA8655SHB-NP**  
Shanghai Brown



**CHA8655SHK-NP**  
Shellish Kiwi



**CHA8655DM-NP**  
Denim



CHA8655OSB-NP  
Oslo Blue



Bernd and Hilla Becher  
Lange  
Woman in the Mirror Richard Avedon

**CHA8590ICO-NP**  
**Khan Square Tapered**  
**Table Lamp in**  
**Coconut with Natural**  
**Paper Shade**  
 Height: 31.25"  
 Width: 19"  
 Base: 6.5" Square

**Finishes:**  
 DM, ICO, OSB,  
 SHB, SHK  
**Shade Treatments:**  
 NP  
**Shade Details:**  
 16" x 19" x 11"  
 Square

**Socket:** Dimmer  
**Wattage:** 150 A

**Designer:**  
 E. F. Chapman

©EFC DESIGNS

**CHA8590SHB-NP**  
**Shanghai Brown**



**CHA8590SHK-NP**  
**Shellish Kiwi**

**CHA8590OSB-NP**  
**Oslo Blue**





**CHA8728ICO-NP**  
Weller Bowtie Table  
Lamp in Coconut with  
Natural Paper Shade  
Height: 29.5"  
Width: 19"  
Base: 6.25" Square

**Finishes:**  
DM, ICO, OSB,  
SHB, SHK  
**Shade Treatments:** NP  
**Shade Details:**  
17" x 19" x 9"  
Square

**Socket:** On - Off  
**Wattage:** 150 A

**Designer:**  
E. F. Chapman

©EFC DESIGNS



**CHA8728SHB-NP**  
Shanghai Brown



**CHA8728SHK-NP**  
Shellish Kiwi



**CHA8728OSB-NP**  
Oslo Blue





**CHA8666SHB-NP**  
Weller Zig-Zag Table  
Lamp in Shanghai  
Brown with Natural  
Paper Shade  
Height: 26.5"  
Width: 19"  
Base: 8" Round

**Finishes:**  
DM, ICO, OSB,  
SHB, SHK  
**Shade Treatments:** NP  
**Shade Details:**  
15.5" x 19" x 10.5"

**Socket:** On - Off  
**Wattage:** 150 A

**Designer:**  
E. F. Chapman

©EFC DESIGNS



**CHA8666SHK-NP**  
Shellish Kiwi



**CHA8666OSB-NP**  
Oslo Blue



**CHA8666DM-NP**  
Denim



**CHA8663ICO-NP**  
**Yue Double Gourd**  
**Table Lamp in**  
**Coconut with Natural**  
**Paper Shade**  
 Height: 31.25"  
 Width: 22"  
 Base: 7" Round

**Finishes:**  
 DM, ICB, ICO  
**Shade Treatments:** NP  
**Shade Details:**  
 9" x 22" x 13"

**Socket:** Dimmer  
**Wattage:** 100 A

**Designer:**  
 E. F. Chapman

©EFC DESIGNS



**CHA8663ICB-NP**  
**Ice Blue**



**CHA8661ICO-NP**  
**Lambay Table Lamp**  
**in Coconut with**  
**Natural Paper Shade**  
 Height: 35.5"  
 Width: 22"  
 Base: 7" Round

**Finishes:**  
 DM, ICB, ICO  
**Shade Treatments:** NP  
**Shade Details:**  
 9" x 22" x 13"

**Socket:** Dimmer  
**Wattage:** 100 A

**Designer:**  
 E. F. Chapman

©EFC DESIGNS



**CHA8661ICB-NP**  
**Ice Blue**





**CHA8642TS-NP**  
**Arc Pot Form Table**  
**Lamp in Tea Stain**  
**Porcelain with Natural**  
**Paper Shade**  
Height: 29.25"  
Width: 19"  
Base: 6.5" Round

**Finishes:**  
G, TS, WHT  
**Shade Treatments:** NP  
**Shade Details:**  
15" x 19" x 12"

**Socket:** Dimmer  
**Wattage:** 150 A

**Designer:**  
E. F. Chapman

©EFC DESIGNS



**CHA8628IC-NP**  
**Fang Gourd**  
**Bedside Lamp in**  
**Ivory Crackle with**  
**Natural Paper Shade**  
 Height: 16"  
 Width: 10.75"  
 Base: 4" Square

**Finishes:** AB, CG, IC  
**Shade Treatments:** NP  
**Shade Details:**  
 8" x 10.75" x 7" Square

**Socket:** Hi-Lo  
**Wattage:** 100 A

**Designer:**  
 E. F. Chapman

©EFC DESIGNS



**CHA8627IC-NP**  
**Fang Gourd**  
**Table Lamp in**  
**Ivory Crackle with**  
**Natural Paper Shade**  
 Height: 27"  
 Width: 18"  
 Base: 6.25" Square

**Finishes:** AB, IC  
**Shade Treatments:** NP  
**Shade Details:**  
 14" x 18" x 11"  
 Rectangle

**Socket:** Dimmer  
**Wattage:** 150 A

**Designer:**  
 E. F. Chapman

©EFC DESIGNS



**CHA8613TS-NP**  
**Gourd Form Small**  
**Table Lamp in Tea**  
**Stain with Natural**  
**Paper Shade**  
 Height: 26"  
 Width: 16"  
 Base: 6" Square

**Finishes:** CC, TS  
**Shade Treatments:** NP  
**Shade Details:**  
 12" x 16" x 11"

**Socket:** Dimmer  
**Wattage:** 100 A

**Designer:**  
 E. F. Chapman

©EFC DESIGNS



**CHA8615CC-NP**  
**Gourd Form Large**  
**Table Lamp in**  
**Celadon Crackle with**  
**Natural Paper Shade**  
 Height: 34.5"  
 Width: 20"  
 Base: 7.5" Square

**Finishes:** CC, TS  
**Shade Treatments:** NP  
**Shade Details:**  
 15" x 20" x 14"

**Socket:** Dimmer  
**Wattage:** 150 A

**Designer:**  
 E. F. Chapman

©EFC DESIGNS



**CHA8617CC-NP**  
 Narrow Neck Vase  
 Large Table Lamp in  
 Celadon Crackle with  
 Natural Paper Shade  
 Height: 32"  
 Width: 19"  
 Base: 7.5" Round

**Finishes:** CC, TS  
**Shade Treatments:** NP  
**Shade Details:**  
 14" x 19" x 13"

**Socket:** Dimmer  
**Wattage:** 150 A

**Designer:**  
 E. F. Chapman

©EFC DESIGNS



**CHA8617TS-NP**  
 Tea Stain



**CHA8608CC-NP**  
 Deauville Table  
 Lamp in Celadon  
 Crackle with Natural  
 Paper Shade  
 Height: 30.25"  
 Width: 18"  
 Base: 7" Round

**Finishes:** CC, TS  
**Shade Treatments:** NP  
**Shade Details:**  
 16" x 18" x 12"

**Socket:** Dimmer  
**Wattage:** 150 A

**Designer:**  
 E. F. Chapman

©EFC DESIGNS



**CHA8608TS-NP**  
 Tea Stain





CHA8608TS-NP  
Tea Stain



ARN3606BC-L  
Bone Craquelure



ARN3606BLL-L  
Gannet Table Lamp  
in Blue Lagoon  
with Linen Shade  
Height: 29.25"  
Width: 17.5"  
Base: 5" Round

**Finishes:**  
BC, BLL, DC, MS, PA  
**Shade Treatments:** L  
**Shade Details:**  
16.5" x 17.5" x 12.5"

**Socket:** Dimmer  
**Wattage:** 150 A

**Designer:**  
AERIN



ARN3606MS-L  
Marbled Sienna



ARN3606PA-L  
Pebbled Aquamarine



ARN3606DC-L  
Drizzled Cobalt



**ARN3608BLL-L**  
Culloden Table Lamp  
in Blue Lagoon with  
Linen Shade  
Height: 32.5"  
Width: 18"  
Base: 6.5" Round

**Finishes:**  
BC, BLL, MS, PA, VI  
**Shade Treatments:** L  
**Shade Details:**  
18" x 18" x 11"

**Socket:** Dimmer  
**Wattage:** 150 A

**Designer:**  
AERIN



**ARN3608MS-L**  
Marbled Sienna



**ARN3608BC-L**  
Bone Craquelure



**ARN3608VI-L**  
Volcanic Ivory



ARN3608PA-L  
Pebbled Aquamarine



Anish Kapoor  
Julius Shulman Architecture and its Photography  
GEORGIA O'KEEFE A PORTRAIT BY ALFRED STIEGLITZ MMA/ABRAMS



**ARN3610VV-L**  
**Gaios Table Lamp**  
**in Volcanic Verdi**  
**with Linen Shade**  
Height: 30.5"  
Width: 21"  
Base: 5.25" Round

**Finishes:**  
BLL, PHW, VV  
**Shade Treatments:** L  
**Shade Details:**  
21" x 21" x 13"  
**Socket:** Dimmer  
**Wattage:** 150 A  
**Designer:**  
AERIN



**ARN3610BLL-L**  
**Blue Lagoon**



**ARN3013BT-L**  
**Eliot Table Lamp**  
**in Bone Tile with**  
**Linen Shade**  
Height: 36.75"  
Width: 20"  
Base: 8.75" Round

**Finishes:**  
BT, BWV, TOR  
**Shade Treatments:** L  
**Shade Details:**  
20" x 20" x 16"  
**Socket:**  
2 - Pull Chain  
**Wattage:** 2 - 60 A  
**Designer:**  
AERIN



**ARN3013BWV-L**  
**Blue Wave**



**ARN3614SHG-L**  
**Kapila Table Lamp**  
 in Shellish Gray  
 with Linen Shade  
 Height: 28.75"  
 Width: 17"  
 Base: 6.25" Round

**Finishes:**  
 BC, PBC, SHG  
**Shade Treatments:** L  
**Shade Details:**  
 17" x 17" x 12.5"

**Socket:**  
 2 - Keyless  
 with Dimmer  
**Wattage:** 2 - 60 A

**Designer:**  
 AERIN



**ARN3614PBC-L**  
**Polar Blue Crackle**



**ARN3616SHG-L**  
**Aubrey Table Lamp**  
 in Shellish Gray  
 with Linen Shade  
 Height: 33.5"  
 Width: 21"  
 Base: 6" Round

**Finishes:** BC, SHG  
**Shade Treatments:** L  
**Shade Details:**  
 14" x 21" x 15"

**Socket:**  
 2 - Keyless  
 with Dimmer  
**Wattage:** 2 - 60 A

**Designer:**  
 AERIN



**ARN3616BC-L**  
**Bone Craquelure**





ARN3616SHG-L  
Shellish Gray

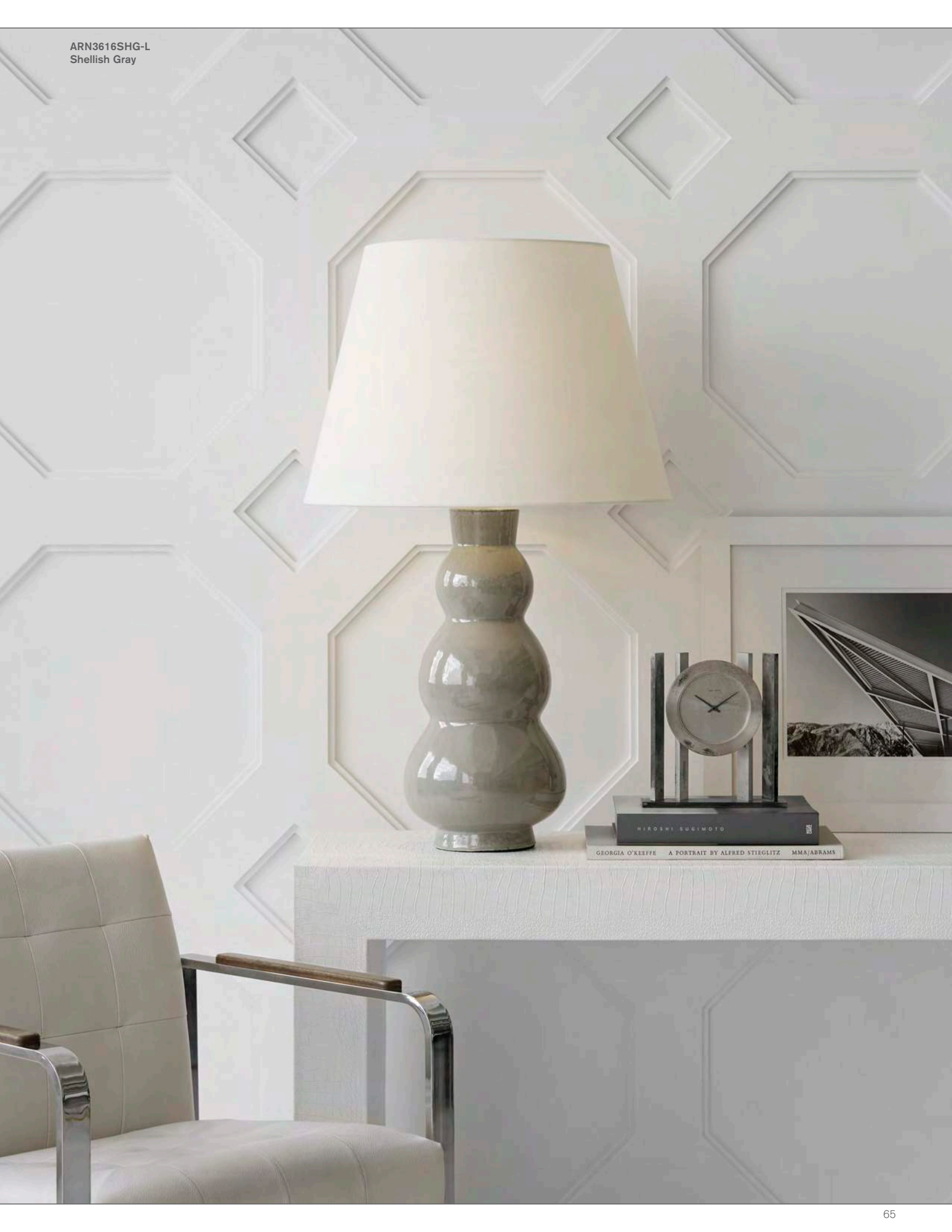

**ARN3623SHG-L**  
**Babette Table Lamp**  
in Shellish Grey  
with Linen Shade  
Height: 30.25"  
Width: 18"  
Base: 5.5" Square

**Finishes:** BG, SHG  
**Shade Treatments:** L  
**Shade Details:**  
18" x 18" x 13.5"

**Socket:**  
2 - Keyless  
with Dimmer  
**Wattage:** 2 - 60 A

**Designer:**  
AERIN



**ARN3623BG-L**  
**Chalk Burnt Gold**



**ARN3622SHG-L**  
**Michelena Table Lamp**  
in Shellish Grey with  
Linen Shade  
Height: 33.75"  
Width: 17"  
Base: 5.25" Round

**Finishes:**  
BG, CHW, SHG  
**Shade Treatments:** L  
**Shade Details:**  
15" x 17" x 16"

**Socket:**  
2 - Keyless  
with Dimmer  
**Wattage:** 2 - 60 A

**Designer:**  
AERIN



**ARN3622BG-L**  
**Chalk Burnt Gold**

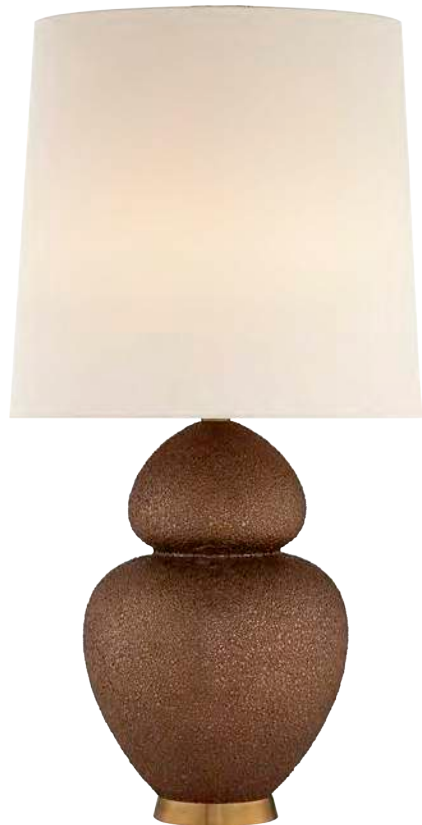

**ARN3620SHG-L**  
**Hunlen Table Lamp**  
 in Shellish Gray  
 with Linen Shade  
 Height: 25.25"  
 Width: 8.5"  
 Base: 4" Round

**Finishes:** BG, SHG  
**Shade Treatments:** L  
**Shade Details:**  
 8.5" x 8.5" x 15"  
 Nordy

**Socket:** Dimmer  
**Wattage:** 75 A

**Designer:**  
 AERIN



**ARN3620BG-L**  
**Chalk Burnt Gold**



**KW3042BGW-L**  
**Marmont Table Lamp**  
 in Burnt Gold and  
 White Porous with  
 Linen Shade  
 Height: 27"  
 Width: 16"  
 Base: 5.25" Round

**Finishes:** BGG, BGW  
**Shade Treatments:** L  
**Shade Details:**  
 8.75" x 16" x 12"

**Socket:** Dimmer  
**Wattage:** 75 A

**Designer:**  
 Kelly Wearstler



**KW3042BGG-L**  
**Chalk Burnt Gold**  
 and Dove Grey



**KW3032PW-L**  
**Linden Table Lamp**  
**in Plaster White**  
**with Linen Shade**  
Height: 32.5"  
Width: 23"  
Base: 9" Round

**Finishes:** BLK, PW  
**Shade Treatments:** L  
**Shade Details:**  
12" x 23" x 14.5"

**Socket:** Dimmer  
**Wattage:** 100 A

**Designer:**  
Kelly Wearstler



**KW3025IGD-L**  
**Bijou Table Lamp**  
 Dotty Ivory and  
 Burnt Gold with  
 Linen Shade  
 Height: 28"  
 Width: 14"  
 Base: 8.25" Round

**Finishes:**  
 BCB, CBC, GDA, IGD  
**Shade Treatments:** L  
**Shade Details:**  
 12" x 14" x 11.5"

**Socket:** On - Off  
**Wattage:** 100 A

**Designer:**  
 Kelly Wearstler



**KW3025BCB-L**  
 Black and Crystal  
 Bronze Dot



**KW3046WLC-L**  
**Bayliss Table Lamp**  
 in White Leather  
 Ceramic with  
 Linen Shade  
 Height: 31.75"  
 Width: 17"  
 Base: 8" Square

**Finishes:** BLK, WLC  
**Shade Treatments:** L  
**Shade Details:**  
 11" x 17" x 12.5"

**Socket:** On - Off  
**Wattage:** 150 A

**Designer:**  
 Kelly Wearstler



**KW3046BLK-L**



**KW3034ICP-L**  
**Sonara Table Lamp**  
 in Ivory and Chalk  
 Black Pearl with  
 Linen Shade

Height: 32"  
 Width: 13.5"  
 Base: 6" Round

**Finishes:** ICP  
**Shade Treatments:** L  
**Shade Details:**  
 12.75" x 13.5" x 12.25"

**Socket:** Dimmer  
**Wattage:** 100 A

**Designer:**  
 Kelly Wearstler



**KW3036TSH-L**  
**Revello Table Lamp**  
 in Tiger Shell  
 with Linen Shade

Height: 32"  
 Width: 13.5"  
 Base: 5" Round

**Finishes:** MLG, TSH  
**Shade Treatments:** L  
**Shade Details:**  
 8.75" x 13.5" x 12.25"

**Socket:** Dimmer  
**Wattage:** 75 A

**Designer:**  
 Kelly Wearstler



**KW3021SBU-L**  
**Effie Table Lamp**  
 in Sand and  
 Blue Stripes with  
 Linen Shade

Height: 28"  
 Width: 14"  
 Base: 8.25" Round

**Finishes:** SBU  
**Shade Treatments:** L  
**Shade Details:**  
 12" x 14" x 10.5"

**Socket:** On - Off  
**Wattage:** 100 A

**Designer:**  
 Kelly Wearstler



**KW3024PWI-L**  
**Alta Table Lamp**  
 in Porous White  
 with Linen Shade

Height: 30"  
 Width: 14"  
 Base: 5.25" Round

**Finishes:** PWI, SBK  
**Shade Treatments:** L  
**Shade Details:**  
 12" x 14" x 11"

**Socket:** On - Off  
**Wattage:** 100 A

**Designer:**  
 Kelly Wearstler



KW3024SBK-L  
Sand and Wide  
Black Stripe



**TOB3710TS-NP**  
**Tamaso Small Table Lamp in Tea Stain Porcelain with Natural Paper Shade**  
 Height: 31" - 34.75"  
 Width: 14.5"  
 Base: 7.5" Square

**Finishes:** BLK, TS  
**Shade Treatments:** NP  
**Shade Details:**  
 13" x 14.5" x 14.5"

**Socket:** 2 - Pull-Chain  
**Wattage:** 2 - 60 A

**Designer:**  
 Thomas O'Brien

TOB3710BLK-NP



**TOB3780WTC-NP**  
**Melrose Table Lamp in White Crackle with Natural Paper Shade**  
 Height: 42.5"  
 Width: 22"  
 Base: 8" Round

**Finishes:** MBB, WTC  
**Shade Treatments:** NP  
**Shade Details:**  
 11" x 22" x 17"

**Socket:** 2 - Pull Chain  
**Wattage:** 2 - 75 A

**Designer:**  
 Thomas O'Brien

TOB3780MBB-NP





**TOB3804TS-NP**  
**Mimi Table Lamp**  
in Tea Stain with  
Natural Paper Shade  
Height: 27.5"  
Width: 16.5"  
Base: 7" x 10"  
Rectangle

TOB3804BLK-NP

**Finishes:** BLK, TS  
**Shade Treatments:** NP  
**Shade Details:**  
12" x 16.5" x 12.75"

**Socket:** 2 - Pull Chain  
**Wattage:** 2 - 75 A

**Designer:**  
Thomas O'Brien



**TOB3807TS-NP**  
**Nara Table Lamp**  
in Tea Stain with  
Natural Paper Shade  
Height: 24"  
Width: 21"  
Base: 12"

TOB3807BLK-NP

**Finishes:** BLK, TS  
**Shade Treatments:** NP  
**Shade Details:**  
17" x 21" x 11.25"

**Socket:**  
2 - Pull Chain  
**Wattage:** 2 - 75 A

**Designer:**  
Thomas O'Brien



**TOB3386MLG-NP**  
**Ciro Small Table**  
**Lamp in Mottled Light**  
**Grey with Natural**  
**Paper Shade**  
 Height: 26.5"  
 Width: 14"  
 Base: 5.75" Square

**Finishes:** MBB, MLG  
**Shade Treatments:** NP  
**Shade Details:**  
 13" x 14" x 10"

**Socket:** 2 - Pull Chain  
**Wattage:** 2 - 60 A

**Designer:**  
 Thomas O'Brien



**TOB3386MBB-NP**  
**Mixed Blue Brown**



**TOB3387MLG-NP**  
**Ciro Large Table**  
**Lamp in Mottled Light**  
**Grey with Natural**  
**Paper Shade**  
 Height: 34.25"  
 Width: 18"  
 Base: 7" Square

**Finishes:** MBB, MLG  
**Shade Treatments:** NP  
**Shade Details:**  
 15" x 18" x 13"  
 Square

**Socket:** 2 - Pull Chain  
**Wattage:** 2 - 60 A

**Designer:**  
 Thomas O'Brien



**TOB3387MBB-NP**  
**Mixed Blue Brown**







**AH3063TS-NP**  
**Anita Table**  
 Lamp in Tea Stain  
 Porcelain with  
 Natural Paper Shade  
 Height: 28.5"  
 Width: 18"  
 Base: 4.75" x 7"  
 Rectangle

**Finishes:** MB, TS  
**Shade Treatments:** NP  
**Shade Details:**  
 14" x 18" x 11"  
 Rectangle

**Socket:** Dimmer  
**Wattage:** 150 A

**Designer:**  
 Alexa Hampton



**AH3063MB-NP**  
**Midnight Blue**



**AH3082TS-NP**  
**Sawyer Table**  
 Lamp in Tea Stain  
 Porcelain with  
 Natural Paper Shade  
 Height: 25"  
 Width: 13.75"  
 Base: 7" Round

**Finishes:** MB, TS  
**Shade Treatments:** NP  
**Shade Details:**  
 7.75" x 13.75" x 9.25"

**Socket:** Dimmer  
**Wattage:** 100 A

**Designer:**  
 Alexa Hampton



**AH3082MB-NP**  
**Midnight Blue**



**AH3125WHT-PL**  
**Eloise Table Lamp**  
 in White with Natural  
 Percale Shade  
 Height: 26"  
 Width: 17"  
 Base: 6" Round

**Finishes:**  
 BYR, DM, GRN, WHT  
**Shade Treatments:** PL  
**Shade Details:**  
 9" x 17" x 12.75"

**Socket:** 2 - Pull Chain  
**Wattage:** 2 - 60 A

**Designer:**  
 Alexa Hampton



**AH3125DM-PL**  
 Denim

**AH3125GRN-PL**  
 Green

**AH3127WHT-PL**  
**Penelope Table Lamp**  
 in White with Natural  
 Percale Shade  
 Height: 30"  
 Width: 17"  
 Base: 6" Round

**Finishes:**  
 BYR, DM, GRN, WHT  
**Shade Treatments:** PL  
**Shade Details:**  
 9" x 17" x 12.75"

**Socket:**  
 2 - Pull Chain  
**Wattage:** 2 - 60 A

**Designer:**  
 Alexa Hampton



**AH3127DM-PL**  
 Denim

**AH3127GRN-PL**  
 Green

**AH3125BYR-PL**  
**Eloise Table Lamp**  
 in Berry Red with  
 Natural Percale Shade

Height: 26"  
 Width: 17"  
 Base: 6" Round

**Finishes:**  
 BYR, DM, GRN, WHT  
**Shade Treatments:** PL  
**Shade Details:**  
 9" x 17" x 12.75"

**Socket:** 2 - Pull Chain  
**Wattage:** 2 - 60 A

**Designer:**  
 Alexa Hampton



**AH3127BYR-PL**  
**Penelope Table Lamp**  
 in Berry Red with  
 Natural Percale Shade

Height: 30"  
 Width: 17"  
 Base: 6" Round

**Finishes:**  
 BYR, DM, GRN, WHT  
**Shade Treatments:** PL  
**Shade Details:**  
 9" x 17" x 12.75"

**Socket:** 2 - Pull Chain  
**Wattage:** 2 - 60 A

**Designer:**  
 Alexa Hampton



**AH3110BW-PL**  
**Brewster Table Lamp**  
 in Blue and White  
 Porcelain with Natural  
 Percale Shade

Height: 29.75"  
 Width: 22"  
 Base: 5" Round

**Finishes:** BW  
**Shade Treatments:** PL  
**Shade Details:**  
 10" x 22" x 15"

**Socket:** 2 - Pull Chain  
**Wattage:** 2 - 60 A

**Designer:**  
 Alexa Hampton



**AH3115BW-PL**  
**Wells Table Lamp**  
 in Blue and White with  
 Natural Percale Shade

Height: 30.75"  
 Width: 20"  
 Base: 8" Round

**Finishes:** BW  
**Shade Treatments:** PL  
**Shade Details:**  
 10" x 20" x 14"

**Socket:** 2 - Pull Chain  
**Wattage:** 2 - 60 A

**Designer:**  
 Alexa Hampton



ARN3004GRM-L  
Green Marble





**ARN3004BM-L**  
**Cliff Table Lamp in**  
**Black Marble with**  
**Linen Shade**  
Height: 30"  
Width: 17"  
Base: 5.5" Round

**Finishes:**  
BM, BRM, GRM  
**Shade Treatments:** L  
**Shade Details:**  
17 "x 17" x 12.5"

**Socket:** Dimmer  
**Wattage:** 150 A

**Designer:**  
AERIN



**ARN3004BRM-L**  
**Brown Marble**



**ARN3011TOR-L**  
**Beecher Table Lamp**  
**in Faux Tortoise with**  
**Linen Shade**  
Height: 29.25"  
Width: 16"  
Base: 5.25" Square

**Finishes:** TOR  
**Shade Treatments:** L  
**Shade Details:**  
15" x 16" x 10"  
Rectangle

**Socket:** Dimmer  
**Wattage:** 150 A

**Designer:**  
AERIN



**ARN3013TOR-L**  
**Eliot Table Lamp**  
**in Tortoise with**  
**Linen Shade**  
Height: 36.75"  
Width: 20"  
Base: 8.75" Round

**Finishes:** TOR  
**Shade Treatments:** L  
**Shade Details:**  
20" x 20" x 16"

**Socket:**  
2 - Pull Chain  
**Wattage:** 2 - 60 A

**Designer:**  
AERIN



**ARN3036LIM-L**  
**Yvette Table Lamp**  
 in Limestone with  
 Linen Shade  
 Height: 30.25"  
 Width: 22"  
 Base: 7.25" Round

**Finishes:** ALB, LIM  
**Shade Treatments:**  
 L  
**Shade Details:**  
 21.5" x 22" x 12"

**Socket:**  
 2 - Keyless  
 with Dimmer  
**Wattage:** 2 - 60 A

**Designer:**  
 AERIN



**ARN3036ALB-L**  
**Alabaster**



**ARN3024ALB-L**  
**Lineham Table Lamp**  
 in Alabaster with  
 Linen Shade  
 Height: 29.5"  
 Width: 18"  
 Base: 4.5" Round

**Finishes:**  
 ALB, CG/HAB, CG/PN  
**Shade Treatments:** L  
**Shade Details:**  
 18" x 18" x 12.5"

**Socket:**  
 2 - Keyless  
 with Dimmer  
**Wattage:** 2 - 60 A

**Designer:**  
 AERIN

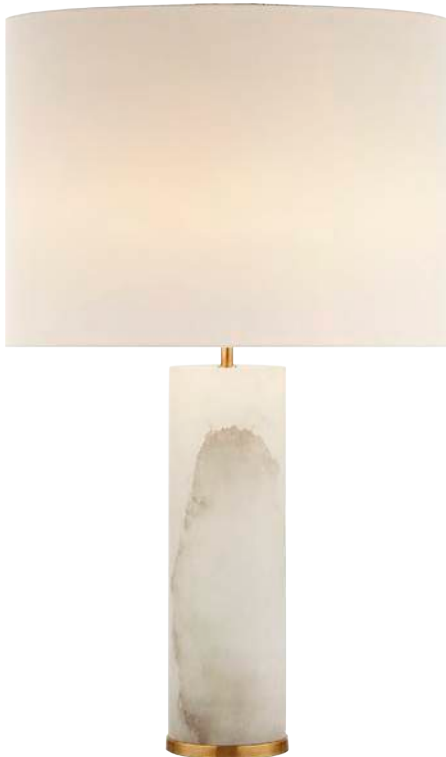

**ARN3026ALB-L**  
**Olsen Table Lamp**  
 in Alabaster and  
 Hand-Rubbed  
 Antique Brass with  
 Linen Shade  
 Height: 32.5"  
 Width: 17"  
 Base: 5" Octagon

**Finishes:**  
 ALB, CG/HAB, CG/PN  
**Shade Treatments:** L  
**Shade Details:**  
 16" x 17" x 12"

**Socket:**  
 2 - Keyless  
 with Dimmer  
**Wattage:** 2 - 60 A

**Note:** French Wired

**Designer:**  
 AERIN



CHA8646ALB-NP  
Contemporary  
Balustrade Table  
Lamp in Alabaster  
with Natural  
Paper Shade  
Height: 30"  
Width: 16"  
Base: 5" Square

Finishes: ALB, CG  
Shade Treatments:  
NP

Shade Details:  
14" x 16" x 10.75"

Socket: Dimmer  
Wattage: 150 A

Designer:  
E. F. Chapman

©EFC DESIGNS



**CHA8974ALB-NP**  
**Quattro Table Lamp**  
**in Alabaster with**  
**Natural Paper Shade**  
Height: 29"  
Width: 19"  
Base: 4.5" x 11"  
Rectangle

**Finishes:** AB, ALB, BZ  
**Shade Treatments:** NP  
**Shade Details:**  
15" x 19" x 12"

**Socket:** Dimmer  
**Wattage:** 150 A

**Note:** French Wired

**Designer:**  
E. F. Chapman

©EFC DESIGNS



**CHA8969ALB-NP**  
**Ring Form Small**  
**Table Lamp in**  
**Alabaster with Natural**  
**Paper Shade**  
 Height: 21"  
 Width: 13.5"  
 Base: 4" x 5.5"  
 Rectangle

**Finishes:**  
 AB, ALB, BZ, CG,  
 G, PN, SN  
**Shade Treatments:** NP  
**Shade Details:**  
 10.5" x 13.5" x 8.5"  
 Rectangle

**Socket:** Hi-Lo  
**Wattage:** 75 A

**Note:** French Wired

**Designer:**  
 E. F. Chapman

©EFC DESIGNS



**CHA8970ALB-NP**  
**Ring Form Large**  
**Table Lamp in**  
**Alabaster with Natural**  
**Paper Shade**  
 Height: 27.25"  
 Width: 18"  
 Base: 4.5" x 7.5"  
 Rectangle

**Finishes:**  
 AB, ALB, BZ, CG,  
 G, PN, SN  
**Shade Treatments:** NP  
**Shade Details:**  
 14" x 18" x 11"  
 Rectangle

**Socket:** Dimmer  
**Wattage:** 100 A

**Note:** French Wired

**Designer:**  
 E. F. Chapman

©EFC DESIGNS



**CHA8924ALB-NP**  
**Balustrade Table Lamp**  
**in Alabaster with**  
**Natural Paper Shade**  
 Height: 27"  
 Width: 17"  
 Base: 5.5" Square

**Finishes:** ALB, CG  
**Shade Treatments:**  
 NP, SBP  
**Shade Details:**  
 13" x 17" x 10"

**Socket:** Hi-Lo  
**Wattage:** 150 A

**Designer:**  
 E. F. Chapman

©EFC DESIGNS



**CHA8931ALB-NP**  
**Chubby Column Table**  
**Lamp in Alabaster**  
**with Natural**  
**Paper Shade**  
 Height: 30.75"  
 Width: 19"  
 Base: 6.5" Square

**Finishes:** ALB  
**Shade Treatments:** NP  
**Shade Details:**  
 15" x 19" x 12"

**Socket:** Hi-Lo  
**Wattage:** 150 A

**Designer:**  
 E. F. Chapman

©EFC DESIGNS



**CHA8945ALB-NP**  
**Round Chunky**  
**Stacked Table Lamp**  
**in Alabaster with**  
**Natural Paper Shade**  
 Height: 29.5"  
 Width: 16"  
 Base: 5" Round

**Finishes:** ALB  
**Shade Treatments:**  
 NP  
**Shade Details:**  
 14" x 16" x 12"

**Socket:** Dimmer  
**Wattage:** 150 A

**Designer:**  
 E. F. Chapman

©EFC DESIGNS



**CHA8947ALB-NP**  
**Square Chunky**  
**Stacked Table Lamp**  
**in Alabaster with**  
**Natural Paper Shade**  
 Height: 31"  
 Width: 16"  
 Base: 5" Square

**Finishes:** ALB  
**Shade Treatments:**  
 NP  
**Shade Details:**  
 14" x 16" x 12"  
 Square

**Socket:** Dimmer  
**Wattage:** 150 A

**Designer:**  
 E. F. Chapman

©EFC DESIGNS



**CHA8960ALB-NP**  
**Rectangular Stacked**  
**Table Lamp in**  
**Alabaster with Natural**  
**Paper Shade**  
 Height: 24"  
 Width: 13.5"  
 Base: 5" x 6.5"  
 Rectangle

**Finishes:** ALB  
**Shade Treatments:** NP  
**Shade Details:**  
 8.5" x 13.5" x 9"  
 Rectangle

**Socket:** Hi-Lo  
**Wattage:** 100 A

**Designer:**  
 E. F. Chapman

©EFC DESIGNS



**CHA8934ALB-NP**  
**Oval Stacked Table**  
**Lamp in Alabaster**  
**with Natural**  
**Paper Shade**  
 Height: 34"  
 Width: 18"  
 Base: 7.75" Oval

**Finishes:** ALB, CG  
**Shade Treatments:** NP  
**Shade Details:**  
 15" x 18" x 12"  
 Oval

**Socket:** Dimmer  
**Wattage:** 150 A

**Designer:**  
 E. F. Chapman

©EFC DESIGNS



**TOB3235ALB-NP**  
**Yumeko Table Lamp**  
**in Alabaster with**  
**Natural Paper Shade**

Height: 27"  
 Width: 18"  
 Base: 4" x 10.5"  
 Rectangle

**Finishes:** ALB  
**Shade Treatments:** NP  
**Shade Details:**  
 16" x 18" x 11.75"  
 Oval

**Socket:** 2 - Pull Chain  
**Wattage:** 2 - 60 A

**Designer:**  
 Thomas O'Brien



**TOB3077ALB-NP**  
**Stanford Large Table**  
**Lamp in Alabaster**  
**with Natural**  
**Paper Shade**

Height: 26.5" - 28.75"  
 Width: 14"  
 Base: 6" Round

**Finishes:** ALB, CG  
**Shade Treatments:** NP  
**Shade Details:**  
 14" x 14" x 9.5"

**Socket:** 2 - Pull Chain  
**Wattage:** 2 - 60 A

**Designer:**  
 Thomas O'Brien



**TOB3011ALB-NP**  
**London Column Table**  
**Lamp in Alabaster**  
**with Natural**  
**Paper Shade**

Height: 38.25"  
 Width: 19.5"  
 Base: 7" Round

**Finishes:** ALB  
**Shade Treatments:** NP  
**Shade Details:**  
 9" x 19.5" x 15.5"

**Socket:** 2 - Pull Chain  
**Wattage:** 2 - 60 A

**Designer:**  
 Thomas O'Brien



**TOB3020ALB-NP**  
**Terri Cube Accent**  
**Lamp in Alabaster**  
**with Natural**  
**Paper Shade**  
 Height: 12.5"  
 Width: 6"  
 Base: 4.5" Square

**Finishes:** ALB, CG  
**Shade Treatments:** NP  
**Shade Details:**  
 4" x 6" x 6"

**Socket:** Hi-Lo  
**Wattage:** 60 A

**Designer:**  
 Thomas O'Brien



**TOB3023ALB-NP**  
**Terri Large Round**  
**Table Lamp in**  
**Alabaster with Natural**  
**Paper Shade**  
 Height: 15"  
 Width: 8"  
 Base: 3" Round

**Finishes:** ALB, CG  
**Shade Treatments:** NP  
**Shade Details:**  
 5" x 8" x 8"

**Socket:** Hi-Lo  
**Wattage:** 75 A

**Note:** French Wired

**Designer:**  
 Thomas O'Brien



**TOB3094ALB-NP**  
**Tina Table Lamp**  
**in Alabaster with**  
**Natural Paper Shade**  
 Height: 23.75"  
 Width: 11"  
 Base: 8" Triangle

**Finishes:** ALB, CG  
**Shade Treatments:** NP  
**Shade Details:**  
 10" x 11" x 11"

**Socket:** Dimmer  
**Wattage:** 75 A

**Note:** French Wired

**Designer:**  
 Thomas O'Brien



**TOB3095ALB-NP**  
**Tina Table Lamp**  
**in Alabaster with**  
**Natural Paper Shade**  
 Height: 34.5"  
 Width: 13"  
 Base: 8" Triangle

**Finishes:** ALB, CG  
**Shade Treatments:** NP  
**Shade Details:**  
 12" x 13" x 14"

**Socket:** 2 - Pull Chain  
**Wattage:** 2 - 60 A

**Note:** French Wired

**Designer:**  
 Thomas O'Brien





**TOB3096ALB-NP**  
**Tina Buffet Lamp in**  
**Alabaster with**  
**Natural Paper Shade**  
Height: 41"  
Width: 13"  
Base: 6" Triangle

**Finishes:** ALB, CG  
**Shade Treatments:** NP  
**Shade Details:**  
11" x 13" x 14"

**Socket:** 2 - Pull Chain  
**Wattage:** 2 - 60 A

**Note:** French Wired

**Designer:**  
Thomas O'Brien



**AH3100GS-NP**  
**Desmond Table Lamp**  
**in Garden Stone with**  
**Natural Paper Shade**  
 Height: 26"  
 Width: 18"  
 Base: 7.5" Square

**Finishes:** GS, WM  
**Shade Treatments:** NP  
**Shade Details:**  
 10" x 18" x 12"

**Socket:** Dimmer  
**Wattage:** 150 A

**Designer:**  
 Alexa Hampton



**AH3100WM-NP**



**CHA8175ALB-NP**  
**Carved Urn Medium**  
**Table Lamp in**  
**Alabaster with**  
**Natural Paper Shade**  
 Height: 26"  
 Width: 14"  
 Base: 5.5" Square

**Finishes:** ALB  
**Shade Treatments:** NP  
**Shade Details:**  
 12" x 14" x 10"

**Socket:** Dimmer  
**Wattage:** 150 A

**Designer:**  
 E. F. Chapman

©EFC DESIGNS



**CHA8174ALB-NP**  
**Chunky Urn Large**  
**Table Lamp in**  
**Alabaster with**  
**Natural Paper Shade**  
 Height: 37.5"  
 Width: 21"  
 Base: 8.25" Square

**Finishes:** AB, ALB  
**Shade Treatments:** NP  
**Shade Details:**  
 19" x 21" x 14"

**Socket:** Dimmer  
**Wattage:** 150 A

**Designer:**  
 E. F. Chapman

©EFC DESIGNS



**AH3046BM-NP**  
**Burt Table Lamp**  
 in Black Marble with  
 Natural Paper Shade  
 Height: 28"  
 Width: 15"  
 Base: 4.5" Round

AH3046WM-NP

**Finishes:** BM, WM  
**Shade Treatments:** NP  
**Shade Details:**  
 8" x 15" x 11"

**Socket:** 2 - Pull - Chain  
**Wattage:** 2 - 60 A

**Designer:**  
 Alexa Hampton



**TOB3362BM-NP**  
**Michelangelo Buffet**  
**Lamp in Black**  
**Marble with Natural**  
**Paper Shades**  
 Height: 31"  
 Width: 13"  
 Base: 6.5" X 7.5"  
 Rectangle

TOB3362CG-NP

TOB3362ALB-NP

**Finishes:**  
 ALB, BM, CG  
**Shade Treatments:**  
 NP

**Shade Details:**  
 13" x 13" x 7.75"

**Socket:** 2 - Pull - Chain  
**Wattage:** 2 - 60 A

**Designer:**  
 Thomas O'Brien



**KW3088BZ/AB**  
**Cleo Desk Lamp**  
 in Bronze and  
 Antique-Burnished  
 Brass with Antique  
 White Shade  
 Height: 17.5"  
 Width: 16.75"  
 Base: 5" Square

**Finishes:** BZ/AB

**Socket:** Candelabra  
 with Line Switch  
**Wattage:** 60 B

**Designer:**  
 Kelly Wearstler



**KW3091Q-AB**  
**Halcyon Desk**  
 Lamp in Natural  
 Quartz and Brass  
 with Brass Shade  
 Height: 18"  
 Width: 6"  
 Base: 6" Square

**Finishes:** Q  
**Shade Treatments:** AB

**Socket:** Candelabra  
 with Switch on Base  
**Wattage:** 60 B

**Designer:**  
 Kelly Wearstler



**KW3010AB-ALB**  
**Melange Table Lamp**  
 in Antique-Burnished  
 Brass with Alabaster  
 Height: 23"  
 Width: 16.25"  
 Base: 12" Round

**Finishes:** AB, BZ  
**Shade Treatments:**  
 ALB

**Socket:** Keyless  
 with Dimmer  
**Wattage:** 60 B

**Designer:**  
 Kelly Wearstler



**KW3010BZ-ALB**







**TOB3195BSL-NP**  
Silhouette Vase Accent  
Lamp in Burnished  
Silver Leaf and  
Quartz with Natural  
Paper Shade  
Height: 21.5"  
Width: 7.5"  
Base: 3.5" x 5"  
Rectangle

TOB3195GI-NP

**Finishes:** BSL, GI  
**Shade Treatments:** NP  
**Shade Details:**  
7" x 7.5" x 9"

**Socket:**  
2 - Candelabra  
**Wattage:** 2 - 40 B

**Designer:**  
Thomas O'Brien

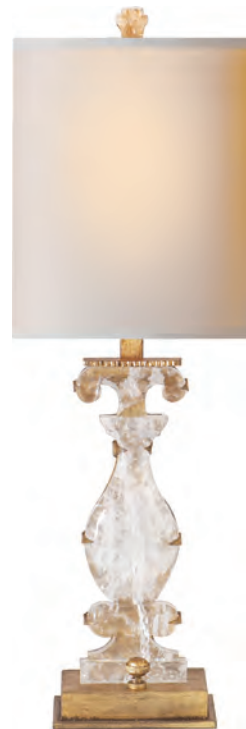
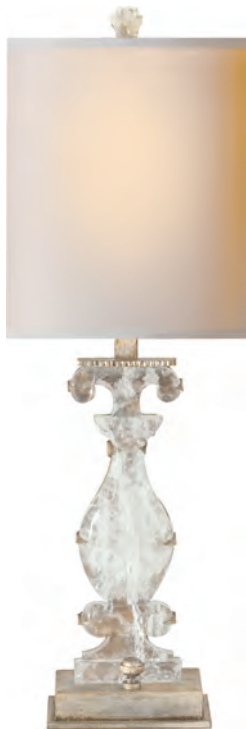

**ARN3030BSL-L**  
Trieste Table Lamp  
in Burnished Silver  
Leaf and Quartz  
with Linen Shade  
Height: 29.25"  
Width: 17"  
Base: 5.5" Square

ARN3030HAB-L

**Finishes:** BSL, HAB  
**Shade Treatments:** L  
**Shade Details:**  
17" x 17" x 13"  
Rectangle

**Socket:** Hi-Lo  
**Wattage:** 150 A

**Designer:**  
AERIN



**MS3002QS-NP**  
**Crescent Table Lamp**  
**in Quartz and Antique**  
**Silver Leaf with**  
**Natural Paper Shade**  
 Height: 27"  
 Width: 18"  
 Base: 3.25" x 9"  
 Rectangle

**Finishes:** Q, QS  
**Shade Treatments:** NP  
**Shade Details:**  
 15" x 18" x 11.75"  
 Rectangle

**Socket:** 2 - Pull Chain  
**Wattage:** 2 - 60 A

**Designer:**  
 Michael S Smith

MS3002Q-NP



**SP3005Q-NP**  
**Cameron Table Lamp**  
**in Quartz and**  
**Gilded Iron with**  
**Natural Paper Shade**  
 Height: 28"  
 Width: 17"  
 Base: 12" Cross

**Finishes:** CG, PAR, Q  
**Shade Treatments:** NP  
**Shade Details:**  
 13" x 17" x 11"

**Socket:** Hi-Lo  
**Wattage:** 150 A

**Note:** French Wired

**Designer:**  
 J. Randall Powers

SP3005PAR-NP









**CHA8359WGL-NP**  
**Chunky Classic Urn**  
**Form Table Lamp**  
**in Weathered White**  
**and Gold with**  
**Natural Paper Shade**  
 Height: 29"  
 Width: 17"  
 Base: 7.25" Round

**Finishes:** WGL  
**Shade Treatments:** NP  
**Shade Details:**  
 13" x 17" x 10"

**Socket:** Dimmer  
**Wattage:** 150 A

**Designer:**  
 E. F. Chapman

©EFC DESIGNS



**CHA8180WGL-NP**  
**Bowen Spiral Table**  
**Lamp in Weathered**  
**White and Gold with**  
**Natural Paper Shade**  
 Height: 30.75"  
 Width: 19"  
 Base: 8" Square

**Finishes:** WGL  
**Shade Treatments:** NP  
**Shade Details:**  
 15" x 19" x 12"

**Socket:** Dimmer  
**Wattage:** 150 A

**Designer:**  
 E. F. Chapman

©EFC DESIGNS



**SL3338OW-L**  
**Square Medium**  
**Balustrade Table**  
**Lamp in Old**  
**White on Wood**  
**with Linen Shade**  
 Height: 26"  
 Width: 16"  
 Base: 5.75" Square

**Finishes:**  
 AI, CG, GI, OW  
**Shade Treatments:**  
 L, NP, S  
**Shade Details:**  
 11" x 16" x 10"  
 Square

**Socket:** Hi-Lo  
**Wattage:** 150 A

**Designer:**  
 E. F. Chapman

©EFC DESIGNS



**SL3339OW-NP**  
**Round Medium**  
**Balustrade Table**  
**Lamp in Old**  
**White with Natural**  
**Paper Shade**  
 Height: 29.25"  
 Width: 17"  
 Base: 5.75" Square

**Finishes:** CG, OW  
**Shade Treatments:**  
 NP, SBP  
**Shade Details:**  
 13" x 17" x 10"

**Socket:** Hi-Lo  
**Wattage:** 100 A

**Designer:**  
 E. F. Chapman

©EFC DESIGNS



**CHA8162SN-NP**  
 Classical Urn Form  
 Large Table Lamp in  
 Sheffield Nickel with  
 Natural Paper Shade  
 Height: 35"  
 Width: 20"  
 Base: 9" Round

**Finishes:**  
 AB, PS, SN  
**Shade Treatments:**  
 B, NP  
**Shade Details:**  
 11" x 20" x 13"  
**Socket:** Hi-Lo  
**Wattage:** 100 A

**Designer:**  
 E. F. Chapman

©EFC DESIGNS



**CHA8162AB-NP**



**CHA8172AN-NP**  
 Classical Urn Form  
 Medium Table Lamp in  
 Antique Nickel with  
 Natural Paper Shade  
 Height: 24"  
 Width: 15"  
 Base: 6" Round

**Finishes:**  
 AB, AN, SN  
**Shade Treatments:**  
 B, NP  
**Shade Details:**  
 6" x 15" x 8"  
**Socket:**  
 2 - Pull Chain  
**Wattage:** 2 - 40 B

**Designer:**  
 E. F. Chapman

©EFC DESIGNS



**CHA8172AB-NP**

**CHA8173AB-NP**  
 Chunky Urn Medium  
 Table Lamp in  
 Antique-Burnished  
 Brass with Natural  
 Paper Shade  
 Height: 31"  
 Width: 19"  
 Base: 6.75" Square

**Finishes:** AB  
**Shade Treatments:**  
 NP  
**Shade Details:**  
 17" x 19" x 12"  
**Socket:** Dimmer  
**Wattage:** 150 A

**Designer:**  
 E. F. Chapman

©EFC DESIGNS



**CHA8627AB-NP**  
**Fang Gourd Table**  
**Lamp in Antique-**  
**Burnished Brass with**  
**Natural Paper Shade**  
Height: 27"  
Width: 18"  
Base: 6.25" Square

**Finishes:** AB, IC  
**Shade Treatments:** NP  
**Shade Details:**  
14" x 18" x 11"  
Rectangle

**Socket:** Dimmer  
**Wattage:** 100 A

**Designer:**  
E. F. Chapman

©EFC DESIGNS





**ARN3600BSL-L**  
**Warren Mini Table**  
**Lamp in Burnished**  
**Silver Leaf with**  
**Linen Shade**  
Height: 13.25"  
Width: 7"  
Base: 2.5" Round

**Finishes:** BSL, G  
**Shade Treatments:** L  
**Shade Details:**  
6.25" x 7" x 7.25"

**Socket:** Dimmer  
**Wattage:** 60 A

**Designer:**  
AERIN

ARN3600G-L



**ARN3601BSL-L**  
**Warren Table Lamp**  
**in Burnished Silver**  
**Leaf with Linen Shade**  
Height: 32.5"  
Width: 17"  
Base: 4.25" Round

**Finishes:** BSL, G  
**Shade Treatments:** L  
**Shade Details:**  
15" x 17" x 17.5"

**Socket:** Dimmer  
**Wattage:** 150 A

**Designer:**  
AERIN

ARN3601G-L



**ARN3000BSL-L**  
Morton Table Lamp  
in Burnished  
Silver Leaf with  
Linen Shade  
Height: 24.5"  
Width: 16.5"  
Base: 4.5" Round

**Finishes:**  
BSL, CG, G  
**Shade Treatments:** L  
**Shade Details:**  
10" x 16.5" x 12"

**Socket:** Dimmer  
**Wattage:** 100 A

**Designer:**  
AERIN

ARN3000G-L



**ARN3604BSL-L**  
Bleecker Table Lamp  
in Burnished  
Silver Leaf with  
Linen Shade  
Height: 28.25"  
Width: 14"  
Base: 5.25" Round

**Finishes:** BSL, G  
**Shade Treatments:** L  
**Shade Details:**  
11.5" x 14" x 15.5"

**Socket:** Dimmer  
**Wattage:** 150 A

**Designer:**  
AERIN

ARN3604G-L





**ARN3130BSL-L**  
**Lenoir Table Lamp in**  
**Burnished Silver Leaf**  
**with Linen Shade**

Height: 28.5"  
 Width: 15"  
 Base: 5.5" Sculptural

**Finishes:**  
 BSL, CG, G  
**Shade Treatments:** L  
**Shade Details:**  
 12.5" x 15" x 15"

**Socket:** Dimmer  
**Wattage:** 60 A

**Note:** French Wired

**Designer:**  
 AERIN

ARN3130G-L



**ARN3100BSL-L**  
**Cannes Table Lamp in**  
**Burnished Silver Leaf**  
**with Linen Shade**

Height: 31"  
 Width: 17"  
 Base: 8.25" Sculptural

**Finishes:**  
 BSL, CG, G  
**Shade Treatments:** L  
**Shade Details:**  
 17" x 17" x 12.5"

**Socket:** Dimmer  
**Wattage:** 150 A

**Note:** French Wired

**Designer:**  
 AERIN

ARN3100G-L



**TOB3734PW-NP**  
**Carmel Table Lamp**  
 in Plaster White  
 with Natural  
 Paper Shade  
 Height: 19.25"  
 Width: 14"  
 Base: 6" x 8.75"  
 Decorative

**Finishes:**  
 BSL, G, PW  
**Shade Treatments:** NP  
**Shade Details:**  
 12.25" x 14" x 9.5"  
 Oval

**Socket:** Dimmer  
**Wattage:** 75 A

**Designer:**  
 Thomas O'Brien

TOB3734BSL-NP



**TOB3735PW-NP**  
**Sierra Buffet Lamp**  
 in Plaster White with  
 Natural Paper Shade  
 Height: 27.75"  
 Width: 17.5"  
 Base: 5" x 8"  
 Decorative

**Finishes:**  
 BSL, G, PW  
**Shade Treatments:** NP  
**Shade Details:**  
 15.75" x 17.5" x 11.5"  
 Oval

**Socket:** Dimmer  
**Wattage:** 100 A

**Designer:**  
 Thomas O'Brien

TOB3735BSL-NP





**CHA3626GI-NP**  
**Claymore Large Table**  
**Lamp in Gilded**  
**Iron with Natural**  
**Paper Shade**  
Height: 41.75"  
Width: 21"  
Base: 8.25" x 10.5"  
Rectangle

**Finishes:** BSL, GI  
**Shade Treatments:** NP  
**Shade Details:**  
11" x 21" x 12"  
Rectangle

**Socket:** 2 - Pull Chain  
**Wattage:** 2 - 75 A

**Designer:**  
E. F. Chapman



**BBL3003WHT-S**  
**Lotus Table Lamp**  
 in Plaster White  
 with Silk Shade  
 Height: 33"  
 Width: 17"  
 Base: 10" Round

**Finishes:** G, WHT  
**Shade Treatments:** S  
**Shade Details:**  
 16" x 17" x 14"

**Socket:** Dimmer  
**Wattage:** 150 A

**Designer:**  
 Barbara Barry



**BBL3003G-S**



**ARN3070PW-L**  
**Lilian Table Lamp**  
 in Plaster White  
 with Linen Shade  
 Height: 35"  
 Width: 18"  
 Base: 6.25" Sculptural

**Finishes:** CG, PW  
**Shade Treatments:** L  
**Shade Details:**  
 13" x 18" x 13"

**Socket:** Dimmer  
**Wattage:** 150 A

**Designer:**  
 AERIN



**ARN3150G-L**  
**Noir Table Lamp in**  
**Gild with Linen Shade**  
 Height: 28.5"  
 Width: 17"  
 Base: 11.25" Sculptural

**Finishes:** G  
**Shade Treatments:** L  
**Shade Details:**  
 15" x 17" x 12"

**Socket:**  
 2 - Keyless with Dimmer  
**Wattage:** 2 - 60 A

**Designer:**  
 AERIN



**ARN3032WHT-L**  
**Aligre Table Lamp**  
 in White with  
 Linen Shade  
 Height: 30.5"  
 Width: 18"  
 Base: 7.5" Round

**Finishes:**  
 BSL, G, WHT  
**Shade Treatments:** L  
**Shade Details:**  
 17" x 18" x 13.5"

**Socket:**  
 2 - Keyless  
 with Dimmer  
**Wattage:** 2 - 60 A

**Designer:**  
 AERIN



ARN3032G-L



**ARN3002BSL-L**  
**Dover Table Lamp**  
 in Burnished  
 Silver Leaf with  
 Linen Shade  
 Height: 34.75"  
 Width: 18"  
 Base: 7" Round

**Finishes:**  
 AI, BSL, G  
**Shade Treatments:** L  
**Shade Details:**  
 13" x 18" x 13"

**Socket:** Dimmer  
**Wattage:** 150 A

**Designer:**  
 AERIN



ARN3002G-L



**ARN3015BSL-L**  
**Marseille Accent Table**  
**Lamp in Burnished**  
**Silver Leaf with**  
**Linen Shade**  
Height: 20.75"  
Width: 9.75"  
Base: 4" Pentagon

**Finishes:** BSL, G  
**Shade Treatments:** L  
**Shade Details:**  
9.75" x 9.75" x 8.75"

**Socket:** Hi-Lo  
**Wattage:** 60 A

**Designer:**  
AERIN

**ARN3015G-L**



**BBL3012WHT-S**  
**Bodice Table Lamp**  
**in Plaster White**  
**with Silk Shade**  
Height: 34"  
Width: 19.5"  
Base: 5" Round

**Finishes:** G, WHT  
**Shade Treatments:** S  
**Shade Details:**  
18" x 19.5" x 13"

**Socket:** Dimmer  
**Wattage:** 150 A

**Designer:**  
Barbara Barry

**BBL3012G-S**



**CHA8642WHT-NP**  
Arc Pot Form  
Table Lamp in  
Plaster White with  
Natural Paper Shade  
Height: 29.25"  
Width: 19"  
Base: 6.5" Round

**Finishes:**  
G, TS, WHT  
**Shade Treatments:** NP  
**Shade Details:**  
15" x 19" x 12"

**Socket:** Dimmer  
**Wattage:** 150 A

**Designer:**  
E. F. Chapman

©EFC DESIGNS



CHA8642G-NP



**CHA8695WHT-NP**  
Marlborough Table  
Lamp in Plaster  
White with Natural  
Paper Shade  
Height: 30.25"  
Width: 19"  
Base: 7" Round

**Finishes:** G, WHT  
**Shade Treatments:** NP  
**Shade Details:**  
15" x 19" x 12"

**Socket:** Dimmer  
**Wattage:** 150 A

**Designer:**  
E. F. Chapman

©EFC DESIGNS



CHA8695G-NP







**AH3040WHT-NP**  
Lucille Table Lamp  
in Plaster White  
with Natural  
Paper Shade  
Height: 31"  
Width: 18"  
Base: 5" Round

**Finishes:** G, WHT  
**Shade Treatments:** NP  
**Shade Details:**  
10" x 18" x 13"

**Socket:** 2 - Pull Chain  
**Wattage:** 2 - 60 A

**Designer:**  
Alexa Hampton

AH3040G-NP



**AH3105I-NP**  
Hugo Table Lamp  
in Ivory Porcelain  
with Natural  
Paper Shade  
Height: 25.5"  
Width: 20"  
Base: 6.5" Round

**Finishes:** GW, I  
**Shade Treatments:** NP  
**Shade Details:**  
12" x 20" x 11.5"

**Socket:** Dimmer  
**Wattage:** 150 A

**Designer:**  
Alexa Hampton

AH3105GW-NP







**CHA8530GI-NP**  
Metal Banded Table  
Lamp in Gilded Table  
Iron with Natural  
Paper Shade  
Height: 29"  
Width: 19"  
Base: 7.5" Hexagon

CHA8530AI-NP

**Finishes:** AI, GI  
**Shade Treatments:** NP  
**Shade Details:**  
15" x 19" x 12"

**Socket:** Dimmer  
**Wattage:** 150 A

**Designer:**  
E. F. Chapman

©EFC DESIGNS



**CHA8531GI-NP**  
Rings Table Lamp  
in Gilded Iron  
with Natural  
Paper Shade  
Height: 28"  
Width: 18"  
Base: 4.5" x 11"  
Rectangle

CHA8531AI-NP

**Finishes:** AI, GI  
**Shade Treatments:**  
NP  
**Shade Details:**  
14" x 18" x 11"  
Rectangle

**Socket:** Dimmer  
**Wattage:** 150 A

**Designer:**  
E. F. Chapman

©EFC DESIGNS



**CHA8994GI-NP**  
Russell Modern  
Tripod Table Lamp  
in Gilded Iron with  
Natural Paper Shade  
Height: 28.5"  
Width: 19"  
Base: 10" Tripod

**Finishes:**  
AI, BSL, CG, GI  
**Shade Treatments:**  
NP, PL  
**Shade Details:**  
15.5" x 19" x 10.5"

**Socket:** Dimmer  
**Wattage:** 150 A

**Designer:**  
E. F. Chapman

©EFC DESIGNS



**CHA8994AI-NP**



**TOB3026GI-NP**  
Nina Tapered Table  
Lamp in Gilded  
Iron with Natural  
Paper Shade  
Height: 31"  
Width: 15"  
Base: 12" Round

**Finishes:** AI, GI  
**Shade Treatments:** NP  
**Shade Details:**  
14" x 15" x 9.5"

**Socket:** Hi-Lo  
**Wattage:** 150 A

**Designer:**  
Thomas O'Brien

**TOB3026AI-NP**



**TOB3026GI-NP**  
**Nina Tapered Table**  
**Lamp in Gilded**  
**Iron with Natural**  
**Paper Shade**  
Height: 31"  
Width: 15"  
Base: 12" Round

**Finishes:** AI, GI  
**Shade Treatments:** NP  
**Shade Details:**  
14" x 15" x 9.5"

**Socket:** Hi-Lo  
**Wattage:** 150 A

**Designer:**  
Thomas O'Brien







**S3045BSL-L**  
**Bracelet Table Lamp**  
 in Burnished Silver  
 Leaf with Linen Shade  
 Height: 30.25"  
 Width: 18"  
 Base: 8" Round

**Finishes:**  
 AI, BSL, GI  
**Shade Treatments:** L  
**Shade Details:**  
 18" x 18" x 10"

**Socket:** Hi-Lo  
**Wattage:** 150 A

**Note:** French Wired

**Designer:**  
 Barry Goralnick

S3045AI-L

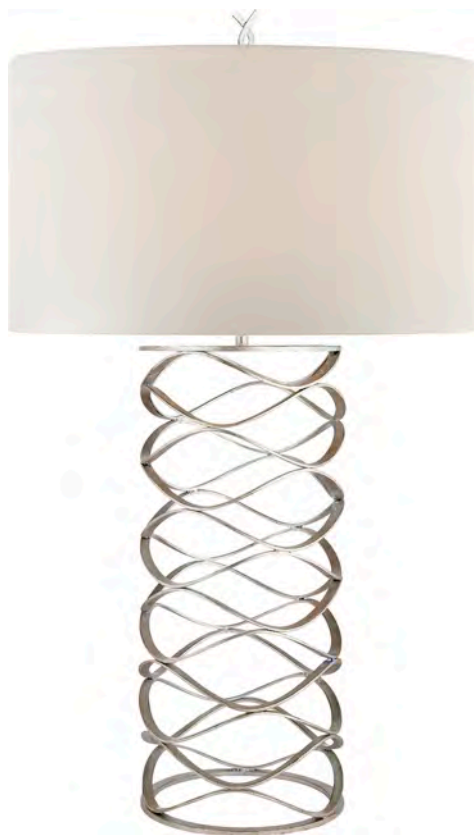

**CHA8141GI-NP**  
**Stapleton Buffet Lamp**  
 in Gilded Iron with  
 Natural Paper Shade  
 Height: 33"  
 Width: 18"  
 Base: 4.5" x 9"  
 Rectangle

**Finishes:** AI, GI  
**Shade Treatments:** NP  
**Shade Details:**  
 14" x 18" x 11"  
 Rectangle

**Socket:** Dimmer  
**Wattage:** 100 A

**Designer:**  
 E. F. Chapman

©EFC DESIGNS

CHA8141AI-NP



**NW3011VS-S**  
**Brittany Table Lamp**  
 in Venetian Silver  
 with Silk Shade  
 Height: 26.5"  
 Width: 12.25"  
 Base: 7.5" Tripod

**Finishes:**  
 Al, VG, VS  
**Shade Treatments:** S  
**Shade Details:**  
 12.25" x 12.25" x 9"

**Socket:** Dimmer  
**Wattage:** 100 A

**Designer:**  
 Niermann Weeks

NW3011AI-S



**TOB3152GI-NP**  
**Parish Buffet Lamp**  
 in Gilded Iron with  
 Natural Paper Shade  
 Height: 31.5"  
 Width: 11.5"  
 Base: 9.5" Tripod

**Finishes:** Al, GI  
**Shade Treatments:** NP  
**Shade Details:**  
 9" x 11.5" x 10"

**Socket:** 2 - Pull Chain  
**Wattage:** 2 - 40 B

**Designer:**  
 Thomas O'Brien

TOB3152AI-NP



**CHA8370GI-NP**  
**Gramercy Buffet Lamp**  
in Gilded Iron with  
Natural Paper Shade  
Height: 36"  
Width: 10"  
Base: 10" Tripod

**Finishes:** GI  
**Shade Treatments:** NP  
**Shade Details:**  
7" x 8" x 8.5"

**Socket:** Hi-Lo  
**Wattage:** 60 B

**Designer:**  
E. F. Chapman

©EFC DESIGNS



**S3400GI-NP**  
**Dauphine Bedside Lamp**  
 in Gilded Iron with  
 Natural Paper Shade  
 Height: 23.5"  
 Width: 12"  
 Base: 5" x 8"  
 Rectangle

**Finishes:** AI, GI  
**Shade Treatments:** NP  
**Shade Details:**  
 10" x 12" x 9.5"

**Socket:** Hi-Lo  
**Wattage:** 100 A

**Note:** French Wired

**Designer:**  
 Studio VC



**S3400AI-NP**



**S3401GI-NP**  
**Dauphine Table Lamp**  
 in Gilded Iron with  
 Natural Paper Shade  
 Height: 31.5"  
 Width: 16"  
 Base: 6" x 9.5"  
 Rectangle

**Finishes:** AI, GI  
**Shade Treatments:**  
 NP  
**Shade Details:**  
 13.5" x 16" x 12.5"

**Socket:** Hi-Lo  
**Wattage:** 150 A

**Note:** French Wired

**Designer:**  
 Studio VC



**S3401AI-NP**



**ARN3022BSL-L**  
**Bristol Table Lamp in**  
**Burnished Silver Leaf**  
**with Linen Shade**

Height: 31"  
 Width: 10"  
 Base: 6.5" Round

**Finishes:** AI, BSL, G  
**Shade Treatments:** L  
**Shade Details:**  
 8" x 10" x 9"

**Socket:** Dimmer  
**Wattage:** 60 A

**Designer:**  
 AERIN

ARN3022G-L

ARN3022AI-L



**S3407BSL-NP**  
**Cranston Buffet**  
**Lamp in Burnished**  
**Silver Leaf with**  
**Natural Paper Shade**

Height: 34.75"  
 Width: 8.5"  
 Base: 7.5" x 4"  
 Rectangle

**Finishes:** AI, BSL, GI  
**Shade Treatments:**  
 NP

**Shade Details:**  
 7" x 8.5" x 7.25"

**Socket:** Dimmer  
**Wattage:** 60 A

**Designer:**  
 Studio VC

S3407GI-NP

S3407AI-NP



**S3051GI-NP**  
**Aspen Console Lamp**  
in Gilded Iron with  
Natural Paper Shade  
Height: 22.5"  
Width: 16"  
Base: 4.5" x 9" Rectangle

**Finishes:** BR, GI  
**Shade Treatments:** NP  
**Shade Details:**  
15" x 16" x 8" Rectangle

**Socket:** 2 - Candelabra  
with Line Switch  
**Wattage:** 2 - 60 B

**Designer:**  
Studio VC



**S3052GI-NP**  
**Vail Table Lamp in**  
**Gilded Iron with**  
**Natural Paper Shade**  
 Height: 21"  
 Width: 20"  
 Base: 12.75" Sculptural

S3052AI-NP

**Finishes:** AI, GI  
**Shade Treatments:** NP  
**Shade Details:**  
 20" x 20" x 8.5" Oval

**Socket:** 2 - Keyless  
 with Line Switch  
**Wattage:** 2 - 60 B

**Designer:**  
 Ian Fowler



**S3054GI-NP**  
**Vail Buffet Lamp in**  
**Gilded Iron with**  
**Natural Paper Shade**  
 Height: 27"  
 Width: 15"  
 Base: 7" Sculptural

S3054AI-NP

**Finishes:** AI, GI  
**Shade Treatments:** NP  
**Shade Details:**  
 15" x 15" x 9"

**Socket:** Keyless  
 with Line Switch  
**Wattage:** 150 A

**Designer:**  
 Ian Fowler



**SK3549GI-L**  
**Quatrefoil Accent Lamp**  
 in Gilded Iron  
 with Linen Shade  
 Height: 18.5"  
 Width: 10"  
 Base: 5" Square

**Finishes:** AI, GI  
**Shade Treatments:** L  
**Shade Details:**  
 10" x 10" x 7.25"

**Socket:** Keyless  
**Wattage:** 60 B

**Designer:**  
 Suzanne Kasler



SK3549AI-L



**SK3500GI-L**  
**Quatrefoil Table Lamp**  
 in Gilded Iron  
 with Linen Shade  
 Height: 35.5"  
 Width: 18"  
 Base: 9.5" Square

**Finishes:**  
 AI, BW, GI  
**Shade Treatments:** L  
**Shade Details:**  
 17.5" x 18" x 13"

**Socket:** Dimmer  
**Wattage:** 150 A

**Designer:**  
 Suzanne Kasler



SK3500AI-L





**SK3100GI-NP**  
**Harper Table Lamp in**  
**Gilded Iron with**  
**Natural Paper Shade**  
Height: 29.5"  
Width: 15.5"  
Base: 3.5" x 12.5"  
Rectangle

**Finishes:** GI, NR  
**Shade Treatments:**  
NP, TL  
**Shade Details:**  
12.5" x 15.5" x 9.5"

**Socket:** Dimmer  
**Wattage:** 150 A

**Designer:**  
Suzanne Kasler





**CHA8906GI-NP**  
**Fluted Spire Large**  
**Table Lamp in**  
**Gilded Iron with**  
**Natural Paper Shade**  
Height: 31.5"  
Width: 17"  
Base: 4.25" Round

**Finishes:**  
AI, BZV, CG, GI, WHT  
**Shade Treatments:** NP  
**Shade Details:**  
13" x 17" x 10"

**Socket:** Dimmer  
**Wattage:** 150 A

**Designer:**  
E. F. Chapman

©EFC DESIGNS

**CHA8707GI-NP**  
**Strie Fluted Column**  
**Table Lamp in**  
**Gilded Iron with**  
**Natural Paper Shade**  
 Height: 29.75"  
 Width: 17"  
 Base: 5.25" x 8"  
 Rectangle

**Finishes:** AI, GI, WHT  
**Shade Treatments:** NP  
**Shade Details:**  
 9" x 17" x 11"

**Socket:** Hi-Lo  
**Wattage:** 100 A

**Designer:**  
 E. F. Chapman

©EFC DESIGNS

CHA8707AI-NP



**CHA8463GI-NP**  
**Strie Buffet Lamp in**  
**Gilded Iron with**  
**Natural Paper Shade**  
 Height: 31.5"  
 Width: 10"  
 Base: 4" x 6" Rectangle

**Finishes:**  
 AI, G, GI, WHT  
**Shade Treatments:** NP  
**Shade Details:**  
 3.5" x 10" x 7" Square

**Socket:** Keyless with  
 Hi-Lo Line Switch  
**Wattage:** 60 B

**Designer:**  
 E. F. Chapman

©EFC DESIGNS

CHA8463AI-NP



**CHA8969PN-NP**  
**Ring Form Small**  
**Table Lamp in**  
**Polished Nickel with**  
**Natural Paper Shade**  
 Height: 21"  
 Width: 13.5"  
 Base: 4" x 5.5"  
 Rectangle

CHA8969AB-NP

CHA8969BZ-NP

**Finishes:**  
 AB, ALB, BZ, CG,  
 G, PN, SN  
**Shade Treatments:** NP  
**Shade Details:**  
 10.5" x 13.5" x 8.5"  
 Rectangle

**Socket:** Hi-Lo  
**Wattage:** 75 A

**Designer:**  
 E. F. Chapman

©EFC DESIGNS



**CHA8970PN-NP**  
**Ring Form Large Table**  
**Lamp in Polished**  
**Nickel with Natural**  
**Paper Shade**  
 Height: 27"  
 Width: 18"  
 Base: 4.5" x 7.5"  
 Rectangle

CHA8970AB-NP

**Finishes:**  
 AB, ALB, BZ, CG,  
 G, PN, SN  
**Shade Treatments:** NP  
**Shade Details:**  
 14" x 18" x 11"  
 Rectangle

**Socket:** Dimmer  
**Wattage:** 100 A

**Designer:**  
 E. F. Chapman

©EFC DESIGNS





**CHA8974AB-NP**  
**Quattro Table Lamp**  
**in Antique-Burnished**  
**Brass with Natural**  
**Paper Shade**  
 Height: 29"  
 Width: 19"  
 Base: 4,5" x 11"  
 Rectangle

**Finishes:**  
 AB, ALB, BZ  
**Shade Treatments:** NP  
**Shade Details:**  
 15" x 19" x 12"

**Socket:** Dimmer  
**Wattage:** 150 A

**Designer:**  
 E. F. Chapman

©EFC DESIGNS



**CHA8974BZ-NP**



**TOB3209HAB-NP**  
**Hammond Column Table**  
**Lamp in Hand-Rubbed**  
**Antique Brass with**  
**Natural Paper Shade**  
 Height: 39"  
 Width: 17,5"  
 Base: 5" x 8"  
 Rectangle

**Finishes:** BZ, HAB  
**Shade Treatments:** NP  
**Shade Details:**  
 15,5" x 17,5" x 11,5"  
 Oval

**Socket:** 2 - Pull Chain  
**Wattage:** 2 - 60 A

**Designer:**  
 Thomas O'Brien



**TOB3209BZ-NP**



**SK3207BSL-L**  
**Mod Low Table**  
**Lamp in Burnished**  
**Silver Leaf with**  
**Linen Shade**  
 Height: 16"  
 Width: 15"  
 Base: 4" x 12"  
 Rectangle

**Finishes:**  
 Al, BSL, G  
**Shade Treatments:**  
 L, TL  
**Shade Details:**  
 15" x 15" x 8"  
 Rectangle

**Socket:** Hi-Lo  
**Wattage:** 60 A

**Designer:**  
 Suzanne Kasler

SK3207G-L



**SK3208BSL-L**  
**Mod Tall Table**  
**Lamp in Burnished**  
**Silver Leaf with**  
**Linen Shade**  
 Height: 28"  
 Width: 14"  
 Base: 5.5" x 7"  
 Rectangle

**Finishes:**  
 Al, BSL, G  
**Shade Treatments:**  
 L, TL  
**Shade Details:**  
 14" x 14" x 10"  
 Rectangle

**Socket:** Hi-Lo  
**Wattage:** 150 A

**Designer:**  
 Suzanne Kasler

SK3208AI-L



**AH3024PN-NP**  
**Kate Table Lamp**  
 in Polished Nickel  
 with Natural  
 Paper Shade  
 Height: 24" - 26.5"  
 Width: 18"  
 Base: 5.75" x 12.75"  
 Rectangle

AH3024NB-NP

**Finishes:** NB, PN  
**Shade Treatments:** NP  
**Shade Details:**  
 14" x 18" x 11"  
 Rectangle

**Socket:**  
 2 - Pull Chain  
**Wattage:** 2 - 60 A

**Designer:**  
 Alexa Hampton



**AH3044PN-NP**  
**Ingrid Table Lamp**  
 in Polished Nickel  
 with Natural  
 Paper Shade  
 Height: 31"  
 Width: 24"  
 Base: 9" Square

AH3044GM-NP

**Finishes:** GM, PN  
**Shade Treatments:**  
 NP  
**Shade Details:**  
 18" x 24" x 11"  
 Rectangle

**Socket:**  
 2 - Pull Chain  
**Wattage:**  
 2 - 75 A

**Designer:**  
 Alexa Hampton







**CHA8254BZ-NP**  
**Darlana Open**  
**Frame Table Lamp**  
**in Bronze with**  
**Natural Paper Shade**  
Height: 26.75"  
Width: 17.5"  
Base: 4.5" x 8.5"  
Rectangle

**Finishes:** AB, BZ, PN  
**Shade Treatments:** NP  
**Shade Details:**  
14.5" x 17.5" x 11.5"  
Rectangle

**Socket:** Dimmer  
**Wattage:** 150 A

**Designer:**  
E. F. Chapman

©EFC DESIGNS



**S3090PN-NP**  
**Cooper Table Lamp**  
 in Polished Nickel  
 with Natural  
 Paper Shade  
 Height: 24.75"  
 Width: 13.5"  
 Base: 6.5" x 4"  
 Rectangle

**Finishes:** BZ, HAB, PN  
**Shade Treatments:** NP  
**Shade Details:**  
 12.5 x 13.5" x 10.5"

**Socket:** Dimmer  
**Wattage:** 75 A

**Designer:**  
 Studio VC

S3090HAB-NP



**S3091HAB-NP**  
**Cooper Buffet Lamp**  
 in Hand-Rubbed  
 Antique Brass with  
 Natural Paper Shade  
 Height: 34"  
 Width: 8"  
 Base: 7" x 4.5"  
 Rectangle

**Finishes:** BZ, HAB, PN  
**Shade Treatments:** NP  
**Shade Details:**  
 7" x 8" x 10"

**Socket:** Dimmer  
**Wattage:** 60 A

**Designer:**  
 Studio VC

S3091BZ-NP



**S3085PN-L**  
**Selene Table Lamp**  
 in Polished Nickel  
 with Linen Shade  
 Height: 29.75"  
 Width: 17"  
 Base: 6.25" Round

**Finishes:** AI, G, PN  
**Shade Treatments:** L  
**Shade Details:**  
 16" x 17" x 10"

**Socket:** Hi-Lo  
**Wattage:** 150 A

**Designer:**  
 Barry Goralnick



S3085AI-L



**CHA8265PN-NP**  
**Darlana Table Lamp**  
 in Polished Nickel  
 with Natural  
 Paper Shade  
 Height: 33.75"  
 Width: 19"  
 Base: 6" Round

**Finishes:**  
 AB, BZ, PN  
**Shade Treatments:** NP  
**Shade Details:**  
 15" x 19" x 12"

**Socket:** Dimmer  
**Wattage:** 150 A

**Designer:**  
 E. F. Chapman

©EFC DESIGNS



CHA8265BZ-NP







**BBL3008SS-S**  
**Carousel Table Lamp**  
 in Soft Silver  
 with Silk Shade  
 Height: 31"  
 Width: 17"  
 Base: 7" Round

**Finishes:** BZ, SS  
**Shade Treatments:** S  
**Shade Details:**  
 16" x 17" x 13"

**Socket:** Dimmer  
**Wattage:** 150 A

**Designer:**  
 Barbara Barry



**BBL3008BZ-S**



**BBL3110SS-S**  
**Framework Desk Lamp**  
 in Soft Silver  
 with Silk Shade  
 Height: 17.5"  
 Width: 10.5"  
 Base: 10.5" Round

**Finishes:**  
 BZ, SB, SS  
**Shade Treatments:** S  
**Shade Details:**  
 9.75" x 9.75" x 7.5"

**Socket:** Keyless  
 with Line Switch  
**Wattage:** 75 A

**Designer:**  
 Barbara Barry



**BBL3110BZ-S**



**BBL3060CW-S**  
**Silhouette Curved**  
**Table Lamp in China**  
**White and Soft Brass**  
**with Silk Shade**  
 Height: 30.75"  
 Width: 16"  
 Base: 5.75" Round

**Finishes:** CW, GY  
**Shade Treatments:** S  
**Shade Details:**  
 15" x 16" x 13.5"

**Socket:** Dimmer  
**Wattage:** 150 A

**Designer:**  
 Barbara Barry



**BBL3060GY-S**



**BBL3050CW-S**  
**Silhouette Straight**  
**Table Lamp in China**  
**White and Soft Brass**  
**with Silk Shade**  
 Height: 30.75"  
 Width: 16"  
 Base: 6.75" Round

**Finishes:** CW, GY  
**Shade Treatments:** S  
**Shade Details:**  
 15" x 16" x 13.5"

**Socket:** Dimmer  
**Wattage:** 150 A

**Designer:**  
 Barbara Barry



**BBL3050GY-S**





**BBL3070BZ-S**  
**Swing Table Lamp**  
**in Bronze with**  
**Silk Shade**  
Height: 21.25"  
Width: 11"  
Extension: 13.25"  
Base: 8" Round

**Finishes:**  
BZ, SB, SS  
**Shade Treatments:** S  
**Shade Details:**  
10.25" x 11" x 10"

**Socket:** Keyless  
with Line Switch  
**Wattage:** 75 A

**Designer:**  
Barbara Barry





**BBL3013SS-S**  
**Coupe Table Lamp**  
 in Soft Silver  
 with Silk Shade  
 Height: 31"  
 Width: 17"  
 Base: 10.5" Round

**Finishes:** BZ, SS  
**Shade Treatments:** S  
**Shade Details:**  
 16" x 17" x 13"

**Socket:** Dimmer  
**Wattage:** 150 A

**Designer:**  
 Barbara Barry



**BBL3013BZ-S**



**BBL3023SS-S**  
**Simple Scallop Table**  
 Lamp in Soft Silver  
 with Silk Shade  
 Height: 26" - 33.5"  
 Width: 15"  
 Base: 8" Round

**Finishes:**  
 BZ, SB, SS  
**Shade Treatments:** S  
**Shade Details:**  
 14" x 15" x 12"

**Socket:** Dimmer  
**Wattage:** 150 A

**Designer:**  
 Barbara Barry



**BBL3023BZ-S**



**TOB3032PAR-NP**  
**Dixon Small Table**  
**Lamp in Parchment**  
**Leather with Natural**  
**Paper Shade**  
 Height: 21"  
 Width: 13.25"  
 Base: 4.5" x 6.75"  
 Rectangle

**Finishes:**  
 ESP, HAB/BZ, PAR  
**Shade Treatments:**  
 BZ, NP  
**Shade Details:**  
 8.5" x 13.25" x 9"  
 Rectangle

**Socket:** 2 - Pull Chain  
**Wattage:** 2 - 60 A

**Designer:**  
 Thomas O'Brien



**TOB3033ESP-NP**  
**Dixon Tall Table**  
**Lamp in Espresso**  
**Leather with Natural**  
**Paper Shade**  
 Height: 30.5"  
 Width: 18"  
 Base: 7.75" x 9.5"  
 Rectangle

**Finishes:**  
 ESP, HAB/BZ, PAR  
**Shade Treatments:**  
 BZ, NP  
**Shade Details:**  
 13.5" x 18" x 11.5"  
 Rectangle

**Socket:**  
 2 - Pull Chain  
**Wattage:** 2 - 60 A

**Designer:**  
 Thomas O'Brien



TOB3032HAB/BZ-BZ



TOB3033HAB/BZ-BZ



**CHA8539AZ-NP**  
**Convactor Rectangular**  
**Table Lamp in**  
**Antique Zinc with**  
**Natural Paper Shade**  
Height: 27"  
Width: 16.5"  
Base: 4.75" x 9.5"  
Rectangle

**Finishes:** AZ  
**Shade Treatments:** NP  
**Shade Details:**  
15" x 16.5" x 10"  
Rectangle

**Socket:** Hi-Lo  
**Wattage:** 150 A

**Designer:**  
E. F. Chapman

©EFC DESIGNS





**KW3085BZ-AB**  
**Zuma Table Lamp**  
 in Bronze with  
 Antique-Burnished  
 Brass Shade  
 Height: 26.5"  
 Width: 17"  
 Base: 6.75" Square

**Finishes:** BZ  
**Shade Treatments:**  
 AB  
**Shade Details:**  
 17" x 17" x 9"

**Socket:**  
 2 - Keyless  
 with Pull Chain  
**Wattage:** 2 - 60 A

**Designer:**  
 Kelly Wearstler



**KW3060AB**  
**Precision Table**  
 Lamp in Antique-  
 Burnished Brass  
 with Frosted Glass  
 Height: 16.25"  
 Width: 4.5"  
 Base: 4.5" Round

**Finishes:**  
 AB, BZ, PN  
**Glass Options:** FG

**Socket:** Keyless  
 with Dimmer  
**Wattage:** 60 T

**Designer:**  
 Kelly Wearstler

KW3060BZ



**KW3055G-L**  
**Utopia Table**  
 Lamp in Gild  
 with Linen Shade  
 Height: 27.5"  
 Width: 15"  
 Base: 4.75" Round

**Finishes:** AI, G  
**Shade Treatments:** L  
**Shade Details:**  
 8" x 15" x 11.75"

**Socket:** On - Off  
**Wattage:** 100 A

**Designer:**  
 Kelly Wearstler



KW3055AI-L



**TOB3051PN-NP**  
**Tiny Terri Round**  
**Accent Lamp in**  
**Polished Nickel with**  
**Natural Paper Shade**  
 Height: 10.25"  
 Width: 5"  
 Base: 2.25" Round

**Finishes:**  
 BZ, CG, HAB, PN  
**Shade Treatments:** NP  
**Shade Details:**  
 3" x 5" x 5.5"

**Socket:** Candelabra  
 with Line Switch  
**Wattage:** 40 B

**Note:** French Wired

**Designer:**  
 Thomas O'Brien

TOB3051HAB-NP

TOB3051BZ-NP



**AH3034NB-NP**  
**Yul Table Lamp in**  
**Natural Brass with**  
**Natural Paper Shade**  
 Height: 29.5"  
 Width: 17"  
 Base: 5.5" Round

**Finishes:** GM, NB  
**Shade Treatments:** NP  
**Shade Details:**  
 10" x 17" x 11"

**Socket:** 2 - Pull Chain  
**Wattage:** 2 - 60 A

**Designer:**  
 Alexa Hampton

AH3034GM-NP





**TOB3000PN-NP**  
**Longacre Small Table**  
**Lamp in Polished**  
**Nickel with Natural**  
**Paper Shade**  
 Height: 16"  
 Width: 9"  
 Base: 5" Round

**Finishes:**  
 BZ, HAB, PN  
**Shade Treatments:** NP  
**Shade Details:**  
 9" x 9" x 6"

**Socket:** 2 - Pull Chain  
**Wattage:** 2 - 25 B

**Designer:**  
 Thomas O'Brien

TOB3000HAB-NP

TOB3000BZ-NP

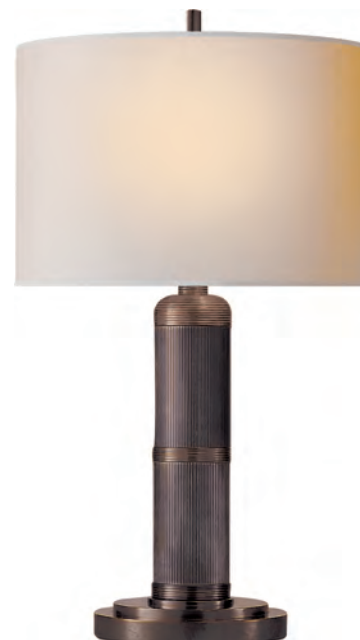

**TOB3001HAB-NP**  
**Longacre Tall Table**  
**Lamp in Hand-Rubbed**  
**Antique Brass with**  
**Natural Paper Shade**  
 Height: 32.5"  
 Width: 20"  
 Base: 10.25" Round

**Finishes:**  
 BZ, HAB, PN  
**Shade Treatments:**  
 NP, NP/BT  
**Shade Details:**  
 20" x 20" x 7.5"

**Socket:** 2 - Pull Chain  
**Wattage:** 2 - 60 B

**Designer:**  
 Thomas O'Brien

TOB3001BZ-NP/BT



**BBL3024SS-S**  
**Petal Desk Lamp**  
**in Soft Silver with**  
**Bronze Mirror Base**  
**and Silk Shade**  
 Height: 25.5"  
 Width: 12.5"  
 Base: 5.5" Square

**Finishes:**  
 BZ, SB, SS  
**Shade Treatments:** S  
**Shade Details:**  
 11.5" x 12.5" x 10.5"

**Socket:** Dimmer  
**Wattage:** 150 A

**Designer:**  
 Barbara Barry



**BBL3024SB-S**



**BBL3025SS-S**  
**Petal Table Lamp**  
**in Soft Silver with**  
**Smoke Mirror Base**  
**and Silk Shade**  
 Height: 30.75"  
 Width: 14.25"  
 Base: 5.5" Square

**Finishes:**  
 BZ, SB, SS  
**Shade Treatments:** S  
**Shade Details:**  
 13.25" x 14.25" x 11.25"

**Socket:** Dimmer  
**Wattage:** 150 A

**Designer:**  
 Barbara Barry



**BBL3025SB-S**





**BBL3030PWT-S**  
**Philosophy Desk**  
**Lamp in Pewter**  
**with Silk Shade**

Height: 17.5"  
 Width: 15"  
 Base: 5.5" x 11"  
 Rectangle

**Finishes:** BZ, PWT  
**Shade Treatments:** S  
**Shade Details:**  
 14.5" x 15" x 8.5"  
 Rectangle

**Socket:** 2 - Pull Chain  
**Wattage:** 2 - 60 B

**Designer:**  
 Barbara Barry

BBL3030BZ-S



**BBL3032PWT-S**  
**Philosophy Candle**  
**Stick Table Lamp**  
**in Pewter**  
**with Silk Shade**

Height: 27"  
 Width: 9.75"  
 Base: 6" Square

**Finishes:** BZ, PWT  
**Shade Treatments:** S  
**Shade Details:**  
 9" x 9.75" x 10.25"

**Socket:** Pull-Chain  
**Wattage:** 60 A

**Designer:**  
 Barbara Barry

BBL3032BZ-S



**TOB3222PN-NP**  
**Mia Table Lamp in Polished Nickel with Natural Paper Shade**  
 Height: 28.5"  
 Width: 16.25"  
 Base: 8.5" Round

TOB3222GI-NP

TOB3222AI-NP

**Finishes:**  
 AI, GI, PN  
**Shade Treatments:** NP  
**Shade Details:**  
 4.5" x 6" x 8"  
**Socket:** Hi-Lo  
**Wattage:** 60 A  
**Designer:**  
 Thomas O'Brien



**TOB3720PN-NP**  
**Jake Buffet Lamp in Polished Nickel with Natural Paper Shade**  
 Height: 36.75" - 45.5"  
 Width: 10"  
 Base: 8.25" x 9" Rectangle

TOB3720SN-NP

TOB3720HAB-NP

**Finishes:**  
 HAB, PN, SN  
**Shade Treatments:**  
 NP  
**Shade Details:**  
 8.5" x 10" x 11"  
**Socket:** Hi-Lo  
**Wattage:** 100 A  
**Designer:**  
 Thomas O'Brien





**TOB3408PN-NP**  
**Baxter Table Lamp in Polished Nickel with Natural Paper Shade**  
 Height: 24" - 33"  
 Width: 8"  
 Base: 7.75" Square

**Finishes:**  
 AN, BZ, HAB, PN  
**Shade Treatments:** NP  
**Shade Details:**  
 5.5" x 8" x 8"

**Socket:** Hi-Lo  
**Wattage:** 60 A

**Designer:**  
 Thomas O'Brien

TOB3408AN-NP



TOB3408HAB-NP



TOB3408BZ-NP



**TOB3007PN-NP**  
**Bryant Table Lamp in Polished Nickel with Natural Paper Shade**  
 Height: 24.5" - 30"  
 Width: 6"  
 Base: 4.25" Round

**Finishes:**  
 AS, BZ, HAB, PN  
**Shade Treatments:** NP  
**Shade Details:**  
 4" x 6" x 6.25"

**Socket:** Keyless with Line Switch  
**Wattage:** 60 A

**Designer:**  
 Thomas O'Brien

TOB3007AS-NP



TOB3007HAB-NP



TOB3007BZ-NP



**TOB3194PN-NP**  
**Caron Table Lamp in Polished Nickel with Natural Paper Shade**  
Height: 26.5"  
Width: 16"  
Base: 10" Tripod

**TOB3194HAB-NP**

**TOB3194BZ/HAB-NP**

**Finishes:**  
BZ/HAB, HAB, PN  
**Shade Treatments:**  
NP

**Shade Details:**  
16" x 16" x 8"

**Socket:**  
2 - Pull Chain  
**Wattage:**  
2 - 60 A

**Designer:**  
Thomas O'Brien



**TOB3193PN-NP**  
**Caron Buffet Lamp in Polished Nickel with Natural Paper Shade**  
Height: 30"  
Width: 11.25"  
Base: 10" Tripod

**TOB3193HAB-NP**

**TOB3193BZ/HAB-NP**

**Finishes:**  
BZ/HAB, HAB, PN  
**Shade Treatments:** NP  
**Shade Details:**  
11.25" x 11.25" x 12"  
Triangle

**Socket:** Dimmer  
**Wattage:** 100 A

**Designer:**  
Thomas O'Brien









**TOB3004CH-WP/ST**  
**Academy Pivoting Desk**  
**in Chrome with**  
**White Paper Shade**  
 Height: 24"  
 Width: 19"  
 Base: 14.5" Round

TOB3004BZ-NP/BT

**Finishes:**  
 BC, BZ, CH  
**Shade Treatments:**  
 NP/BT, WP/ST  
**Shade Details:**  
 19" x 19" x 7"

**Socket:** 2 - Keyless  
 with Line Switch  
**Wattage:** 2 - 60 B

**Designer:**  
 Thomas O'Brien



**TOB3180PN-NP**  
**Kenton Desk Lamp in**  
**Polished Nickel with**  
**Natural Paper Shade**  
 Height: 16"  
 Width: 12"  
 Base: 8" Square

TOB3180HAB-NP

**Finishes:**  
 BZ, HAB, PN  
**Shade Treatments:** NP  
**Shade Details:**  
 12" x 12" x 6"

**Socket:** 2 - Keyless  
 Switch on Base  
**Wattage:** 2 - 40 A

**Designer:**  
 Thomas O'Brien



SP3011PN-NP  
Hargett Buffet  
Lamp in Polished  
Nickel with Natural  
Paper Shade  
Height: 21.5"- 29"  
Width: 11.75"  
Base: 6" Round

**Finishes:**  
BZ, HAB, PN  
**Shade Treatments:** NP  
**Shade Details:**  
2" x 11.75" x 6.5"

**Socket:**  
Keyless Nordy with  
Line-Switch  
**Wattage:** 40 B

**Designer:**  
J. Randall Powers

SP3011HAB-NP



**SK3005PN-NP**  
**Wyatt Accent Lamp in Polished Nickel with Natural Paper Shade**  
 Height: 20.5" - 30"  
 Width: 9"  
 Base: 5.25" Round

**Finishes:**  
 AN, HAB, PN  
**Shade Treatments:** NP  
**Shade Details:**  
 5" x 9" x 7"

**Socket:** Hi-Lo  
**Wattage:** 60 A

**Designer:**  
 Suzanne Kasler



SK3005HAB-NP



**CHA8188AB-B**  
**Dorchester Club Table Lamp in Antique-Burnished Brass with Black Shade**  
 Height: 22" - 32"  
 Width: 13"  
 Base: 7" Round

**Finishes:** AB, PN  
**Shade Treatments:**  
 B, NP, S  
**Shade Details:**  
 8" x 13" x 7"

**Socket:** 2 - Pull Chain  
**Wattage:** 2 - 40 B

**Designer:**  
 E. F. Chapman

©EFC DESIGNS



CHA8188AB-NP



**SP3022PN-NP**  
**Hackney Table Lamp**  
 in Polished Nickel  
 with Natural  
 Paper Shade  
 Height: 23"  
 Width: 11.75"  
 Base: 6" Round

**Finishes:**  
 BZ, HAB, PN  
**Shade Treatments:** NP  
**Shade Details:**  
 3" x 11.75" x 7"

**Socket:**  
 Keyless with Line Switch  
**Wattage:** 60 B

**Designer:**  
 J. Randall Powers

SP3022HAB-NP

SP3022BZ-NP

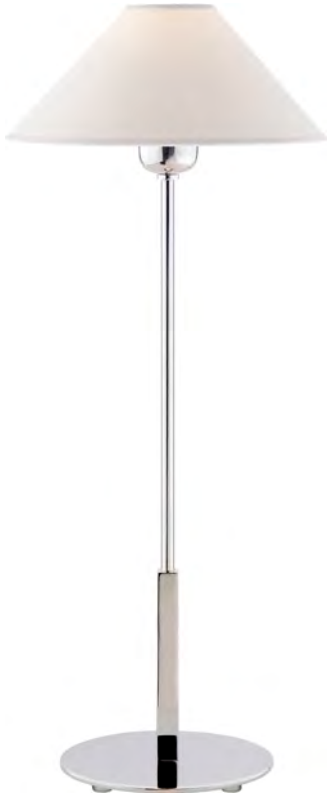

**CHA8315PN-NP**  
**Cawdor Buffet**  
**Lamp in Polished**  
**Nickel with Natural**  
**Paper Shade**  
 Height: 32"  
 Width: 9"  
 Base: 4.25" Square

**Finishes:**  
 AB, AI, GI, PN  
**Shade Treatments:** NP  
**Shade Details:**  
 6.5" x 9" x 8"  
 Square

**Socket:** Hi-Lo  
**Wattage:** 60 A

**Designer:**  
 E. F. Chapman

©EFC DESIGNS

CHA8315AB-NP

CHA8315AI-NP



**SK3610HAB-L**  
**Coral Table Lamp**  
**in Hand-Rubbed**  
**Antique Brass**  
**with Linen Shade**  
Height: 29.5"  
Width: 15.25"  
Base: 6.25" Square

**Finishes:** HAB, PN  
**Shade Treatments:** L  
**Shade Details:**  
11.75" x 15.25" x 9.5"

**Socket:** Dimmer  
**Wattage:** 100 A

**Designer:**  
Suzanne Kasler

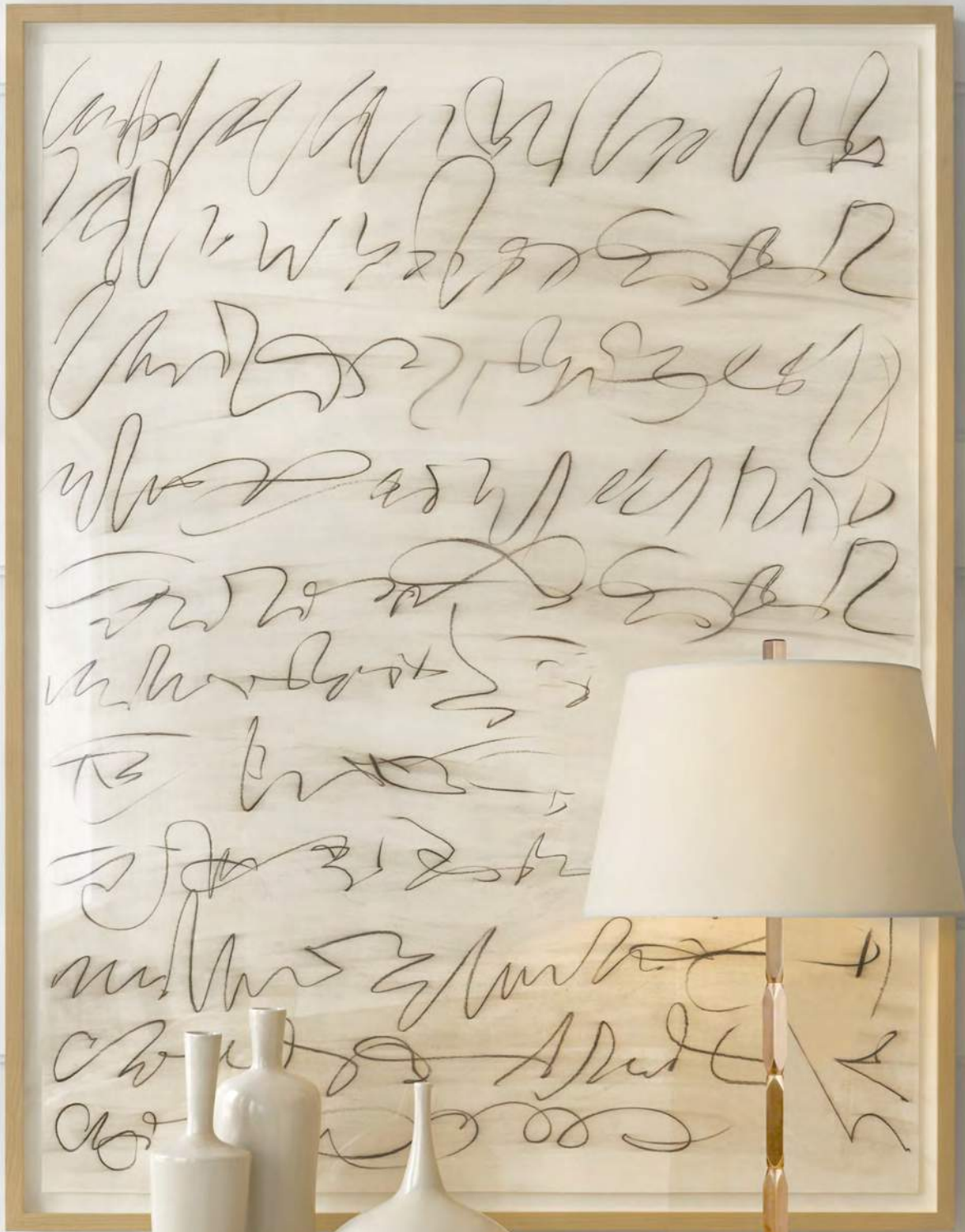

**CHA8710GW-NP**  
**Gustavian Buffet Lamp**  
**in Gilded Wood with**  
**Natural Paper Shade**

Height: 34.25"

Width: 14"

Base: 5" Square

**Finishes:**

BW, CG, GW

**Shade Treatments:** NP

**Shade Details:**

7" x 14" x 8.5"

**Socket:** Dimmer

**Wattage:** 60 A

**Designer:**

E. F. Chapman

©EFC DESIGNS





**AH3049NB-NP**  
**Vivien Table Lamp in Natural Brass with Natural Paper Shade**  
 Height: 27.5"  
 Width: 14"  
 Base: 4" Square

**Finishes:** BM, NB, PN  
**Shade Treatments:** NP  
**Shade Details:**  
 7" x 14" x 8.5"  
 Rectangle

**Socket:** Dimmer  
**Wattage:** 60 A

**Designer:**  
 Alexa Hampton



**CHA8993AB-NP**  
**Entarsus Square Obelisk Table Lamp in Antique-Burnished Brass with Natural Paper Shade**  
 Height: 30"  
 Width: 14"  
 Base: 5" Square

**Finishes:** AB, CG, PN  
**Shade Treatments:** NP  
**Shade Details:**  
 12.5" x 14" x 9.5"  
 Rectangle

**Socket:** Hi-Lo  
**Wattage:** 150 A

**Designer:**  
 E. F. Chapman

©EFC DESIGNS



**SK3008SHS-NP**  
**Josephine Table Lamp in Sheffield Silver with Natural Paper Shade**  
 Height: 32.5"  
 Width: 14"  
 Base: 5" Square

**Finishes:**  
 HAB, LB, SHS  
**Shade Treatments:** NP  
**Shade Details:**  
 12" x 14" x 10"

**Socket:** Dimmer  
**Wattage:** 150 A

**Designer:**  
 Suzanne Kasler



**SK3008HAB-NP**



# FUNCTIONAL TABLE





**TOB3190PN/WHT**  
**Carlo Table Lamp**  
in Polished Nickel  
and Antique White  
Height: 21"  
Width: 15.5"  
Base: 6.75" Round

**Finishes:**  
BZ/HAB, HAB,  
PN, WHT  
**Shade Details:**  
3" x 15.5"

**Socket:**  
Keyless with Hi-Lo  
Switch on Base  
**Wattage:** 60 A

**Designer:**  
Thomas O'Brien

TOB3190PN



TOB3190HAB

TOB3190BZ/HAB



**TOB3142PN**  
**Totie Task Lamp**  
 in Polished Nickel  
 Height: 11"  
 Width: 7"  
 Base: 5.5" Round

TOB3142HAB

TOB3142BZ

**Finishes:**  
 BZ, HAB, PN

**Socket:** Dimmer  
**Wattage:** 40 A

**Designer:**  
 Thomas O'Brien



**TOB3197AN**  
**Henley Task Lamp**  
 in Antique Nickel  
 Height: 13"  
 Width: 8.5"  
 Base: 6" Round

TOB3197HAB

TOB3197BZ

**Finishes:**  
 AN, BZ, HAB, PN

**Socket:** Hi-Lo  
**Wattage:** 60 A

**Designer:**  
 Thomas O'Brien



SL3025AN

The Pixie in

Antique Nickel

Height: 13" - 18.5"

Extension: 16"

Base: 5.5" Round

Finishes:

AN, BZ, HAB, PN

Shade Details:

4.75" x 2.25"

Socket:

Candelabra  
with Hi-Lo

Wattage: 25 B

Designer:

E. F. Chapman

©EFC DESIGNS

SL3025HAB

SL3025BZ



TOB3536PN

Goodman Table Lamp

in Polished Nickel

Height: 19" - 30"

Extension: 17" - 23"

Base: 7" Round

Finishes:

BZ/HAB, HAB, PN

Socket: On-Off

Wattage: 60 A

Designer:

Thomas O'Brien

TOB3536HAB



**TOB3650BZHAB**  
**Tico Task Lamp**  
in Bronze and Hand-  
Rubbed Antique Brass  
Height: 16" - 22"  
Width: 9"  
Extension: 11.5" - 20"  
Base: 9" Round

**Finishes:**  
BLK/PN, BZ/HAB, PN

**Socket:** On-Off  
**Wattage:** 60 A

**Designer:**  
Thomas O'Brien





**TOB3725PN**  
**Jennings Pharmacy**  
**Table Lamp in**  
**Polished Nickel**  
**and Crystal**  
Height: 16.5" - 26.5"  
Width: 5"  
Extension: 13.25"  
Base: 5" x 8.25"  
Rectangle

TOB3725BZ

**Finishes:** BZ, PN

**Socket:** Hi-Lo  
**Wattage:** 60 T

**Designer:**  
Thomas O'Brien



**TOB3206PN/WM**  
**Enrico Table Lamp in**  
**Polished Nickel with**  
**White Marble Base**  
Height: 21.5"  
Extension: 9.25"  
Base: 7" Round

TOB3206HAB/WM

TOB3206BZ/BM

**Finishes:**  
BZ, HAB, PN

**Socket:** On-Off  
**Wattage:** 40 A

**Designer:**  
Thomas O'Brien



**ARN3010HAB-WHT**  
**Clemente Table Lamp**  
 in Hand-Rubbed  
 Antique Brass  
 with White  
 Height: 20.75"  
 Width: 7"  
 Extension: 15.5"  
 Base: 7" Round

ARN3010HAB-BLK

ARN3010HAB-HAB

**Finishes:** HAB  
**Shade Treatments:**  
 BLK, HAB, WHT

**Socket:**  
 Keyless with  
 Toggle on Base  
**Wattage:** 60 A

**Designer:**  
 AERIN



**ARN3008HAB-WHT**  
**Paix Table Lamp in**  
 Hand-Rubbed Antique  
 Brass with White  
 Height: 20"  
 Width: 7.5"  
 Extension: 9.25"  
 Base: 7.5"

ARN3008HAB-BLK

ARN3008HAB-HAB

**Finishes:** HAB  
**Shade Treatments:**  
 BLK, HAB, WHT

**Socket:**  
 Keyless with  
 Line Switch  
**Wattage:** 60 A

**Designer:**  
 AERIN



**ARN3006WHT**  
**Charlton Table Lamp**  
in White and Hand-  
Rubbed Antique Brass  
Height: 17" - 27"  
Width: 9.5"  
Base: 8" Round

**Finishes:** BLK, WHT

**Socket:**  
Keyless with  
Toggle on Base  
**Wattage:** 60 A

**Designer:**  
AERIN

ARN3006BLK



**S3030BR-NP**  
**Aspen Forged Iron**  
**Table Lamp in Black**  
**Rust with Natural**  
**Paper Shade**  
Height: 24.25" - 31.75"  
Width: 6.25"  
Extension: 19.75"  
Base: 6.25" x 8.75"  
Rectangle

**Finishes:** BR, GI  
**Shade Treatments:** NP  
**Shade Details:**  
6" x 6" x 4.5"

**Socket:** Candelabra  
with Line Switch  
**Wattage:** 60 B

**Designer:**  
Ian Fowler



**ARN3003BLK-L**  
**Clarkson Table Lamp**  
 in Hand-Rubbed Antique  
 Brass and Black  
 with Linen Shade  
 Height: 17"  
 Width: 8"  
 Base: 7.5" Round

ARN3003HAB-L

**Finishes:** BLK, HAB  
**Shade Treatments:** L  
**Shade Details:**  
 3.75" x 5" x 5.5"

**Socket:**  
 Keyless with Line Switch  
**Wattage:** 40 B

**Designer:**  
 AERIN



**SK3115PN-L**  
**Graves Task Lamp**  
 in Polished Nickel  
 with Linen Shade  
 Height: 18.25" - 28.75"  
 Width: 13.25" - 16.5"  
 Base: 5.5" x 7.75"  
 Rectangle

SK3115HAB-L

**Finishes:** HAB, PN  
**Shade Treatments:** L  
**Shade Details:**  
 4.5" x 8" x 7.5"

**Socket:**  
 Keyless with On - Off  
 on Base  
**Wattage:** 75 A

**Designer:**  
 Suzanne Kasler



**CHA8150AB-AB**  
**Pimlico Table Lamp**  
 in Antique-Burnished  
 Brass with  
 Antique-Burnished  
 Brass Shade  
 Height: 25" - 32.5"  
 Extension: 20.5"  
 Base: 6" Round

**Finishes:**  
 AB, AN, PN  
**Shade Treatments:**  
 AB, AN, LC, LCF, PN  
**Shade Details:**  
 5" x 9" x 7.5"

**Socket:** Hi-Lo  
**Wattage:** 60 A

**Designer:**  
 E. F. Chapman

©EFC DESIGNS



**CHA8150AB-LC**  
**Pimlico Table Lamp**  
 in Antique-Burnished  
 Brass with Linen  
 Collar Shade  
 Height: 25" - 32.5"  
 Extension: 20.5"  
 Base: 6" Round

**Finishes:**  
 AB, AN, PN  
**Shade Treatments:**  
 AB, AN, LC, LCF, PN  
**Shade Details:**  
 5" x 9" x 7.5"

**Socket:** Hi-Lo  
**Wattage:** 60 A

**Designer:**  
 E. F. Chapman

©EFC DESIGNS



**CHA8192AB-B**  
**Engraver's Desk**  
**Lamp in Antique-**  
**Burnished Brass with**  
**Black Shade**  
 Height: 26" - 48"  
 Extension: 30"  
 Base: 5.5" x 8"  
 Rectangle

**Finishes:** AB  
**Shade Treatments:**  
 B

**Socket:** Hi-Lo  
**Wattage:** 60 A

**Designer:**  
 E. F. Chapman

©EFC DESIGNS



**SL3032HAB**  
**Mini Architect's Table**  
**Lamp in Hand-Rubbed**  
**Antique Brass**  
 Height: 18" - 24"  
 Extension: 24"  
 Base: 6.25" Square

**Finishes:**  
 BZ, HAB, PS  
**Shade Details:**  
 2" x 6.25" x 4.5"

**Socket:** Hi-Lo  
**Wattage:** 40 B or Par

**Designer:**  
 E. F. Chapman

©EFC DESIGNS



**AH3028NB**  
**Kate Easel Light**  
 in Natural Brass  
 Height: 15" - 18"  
 Width: 18"  
 Base: 4" x 16"  
 Rectangle

AH3028PN

**Finishes:**  
 GM, NB, PN

**Socket:** 2 - Keyless  
 with Line Switch  
**Wattage:** 2 - 25 T

**Note:** Lamp Adjusts  
 Vertically/Art  
 Not Included

**Designer:**  
 Alexa Hampton



**AH3500NB**  
**Estelle Display Lamp**  
 in Natural Brass  
 Height: 22.25"  
 Width: 16"  
 Base: 14.5" x 15.5"  
 Triangle

AH3500PN

**Finishes:**  
 GM, NB, PN

**Socket:** Candelabra  
 with Line Switch  
**Wattage:** 40 B

**Note:** Lamp Adjusts  
 Vertically/Art  
 Not Included

**Designer:**  
 Alexa Hampton



**FLOOR**





**DECORATIVE FLOOR**

ARN1002G-L



**ARN1002BSL-L**  
**Dover Floor Lamp in**  
**Burnished Silver Leaf**  
**with Linen Shade**  
Height: 63.5"  
Width: 21.5"  
Base: 9" Round

ARN1002AI-L

**Finishes:**  
AI, BSL, G  
**Shade Treatments:** L  
**Shade Details:**  
18" x 21.5" x 13"  
**Socket:** Dimmer  
**Wattage:** 150 A  
**Designer:**  
AERIN



**ARN1022BSL-L**  
**Bristol Floor Lamp in**  
**Burnished Silver Leaf**  
**with Linen Shade**

Height: 65"  
Width: 22"  
Base: 11.5" Round

**Finishes:** AI, BSL, G  
**Shade Treatments:** L  
**Shade Details:**  
18" x 22" x 15.5"

**Socket:** 2 - Keyless  
with Dimmer  
**Wattage:** 2 - 60 A

**Designer:**  
AERIN

ARN1022AI-L



**SC1105G-NP**  
**Rome Floor Lamp**  
 in Gild with Natural  
 Paper Shade  
 Height: 79.5" - 83.5"  
 Width: 24.5"  
 Base: 16.5" Round

**Finishes:** BZ, G  
**Shade Treatments:** NP  
**Shade Details:**  
 15.5" x 24.5" x 18"

**Socket:** Pull-Chain  
**Wattage:** 150 A

**Designer:**  
 Eric Cohler



**SC1104G-NP**  
**Rome Floor Lamp**  
 in Gild with Natural  
 Paper Shade  
 Height: 70"  
 Width: 20.75"  
 Base: 14" Round

**Finishes:** AI, G  
**Shade Treatments:** NP  
**Shade Details:**  
 13" x 20.75" x 14.75"

**Socket:** Pull-Chain  
**Wattage:** 100 A

**Designer:**  
 Eric Cohler



SC1105BZ-NP







**BBL1002G-S**  
**Lotus Floor Lamp**  
**in Gild with**  
**Silk Shade**  
Height: 68.5"  
Width: 17"  
Base: 13" Round

**Finishes:** G, WHT  
**Shade Treatments:** S  
**Shade Details:**  
16" x 17" x 13"

**Socket:** Dimmer  
**Wattage:** 150 A

**Designer:**  
Barbara Barry

**BBL1002WHT-S**



NW1011VS-S  
Brittany Floor Lamp  
in Venetian Silver  
with Silk Shade  
Height: 67.5"  
Width: 22"  
Base: 14.25" Square

NW1011VG-S

**Finishes:**  
Al, VG, VS  
**Shade Treatments:** S  
**Shade Details:**  
20" x 22" x 13"

**Socket:** Dimmer  
**Wattage:** 60 A

**Designer:**  
Niermann Weeks

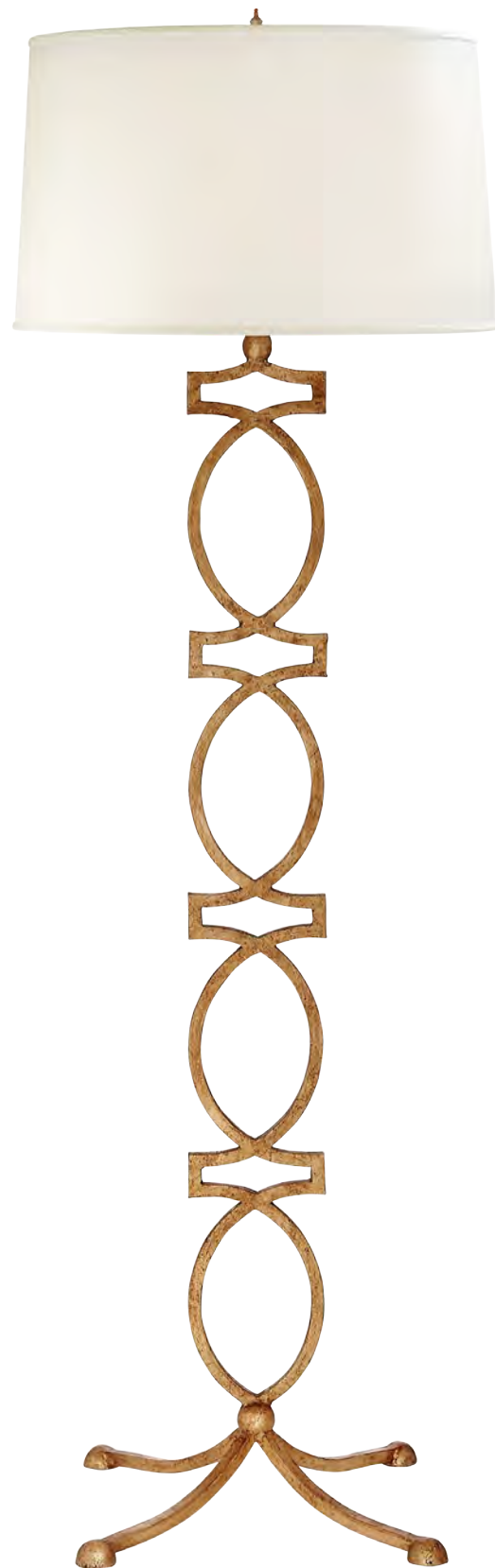
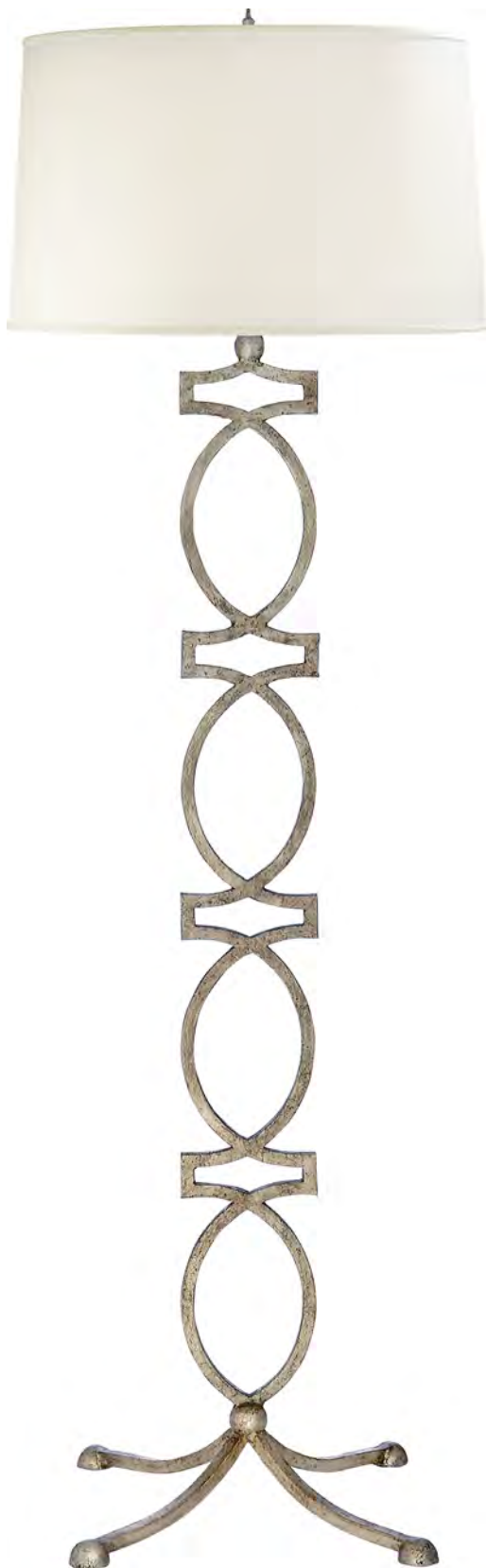

**ARN1000BSL-L**  
**Edgemere Floor Lamp**  
**in Burnished Silver**  
**Leaf with Linen Shade**  
Height: 63.5"  
Width: 18.5"  
Base: 17.25" Tripod

**Finishes:** BSL, G  
**Shade Treatments:** L  
**Shade Details:**  
18.5" x 18.5" x 11.5"

**Socket:** 2 - Pull Chain  
**Wattage:** 2 - 60 A

**Designer:**  
AERIN

**ARN1000G-L**





**SK1500BW-L**  
**Quatrefoil Floor**  
**Lamp in Belgian White**  
**with Linen Shade**  
Height: 68"  
Width: 20"  
Base: 20" Cross

**Finishes:**  
Al, BW, GI  
**Shade Treatments:** L  
**Shade Details:**  
19.5" x 20" x 13"

**Socket:**  
2 - Pull Chain  
**Wattage:**  
2 - 75 A

**Designer:**  
Suzanne Kasler

SK1500AI-L



**SK1200GI-NP**  
**Carey Floor Lamp**  
in Gilded Iron with  
Natural Paper Shade  
Height: 66.25"  
Width: 18"  
Base: 20" Tripod

**Finishes:** AI, GI  
**Shade Treatments:** NP  
**Shade Details:**  
12" x 18" x 13.5"

**Socket:** Hi-Lo  
**Wattage:** 150 A

**Designer:**  
Suzanne Kasler

SK1200AI-NP



**SK1505GI-NP**  
**Madeleine Floor Lamp**  
in Gilded Iron with  
Natural Paper Shade  
Height: 66"  
Width: 21"  
Base: 22" Tripod

**Finishes:**  
Al, BW, GI  
**Shade Treatments:** NP  
**Shade Details:**  
14" x 21" x 14"

**Socket:** Hi-Lo  
**Wattage:** 150 A

**Designer:**  
Suzanne Kasler

**SK1505AI-NP**



**SP1003GI-NP**  
**Wells Floor Lamp**  
in Gilded Iron with  
Natural Paper Shade  
Height: 70.25"  
Width: 19"  
Base: 19" Tripod

**Finishes:** AI, GI  
**Shade Treatments:** NP  
**Shade Details:**  
18" x 19" x 12.5"

**Socket:** Hi-Lo  
**Wattage:** 150 A

**Designer:**  
J. Randall Powers

SP1003AI-NP





**SR1201T-NP**  
**Makis Floor Lamp in**  
**Hand-Painted Greek**  
**Key Tole with Natural**  
**Paper Shade**  
Height: 68.5"  
Width: 20"  
Base: 18.75" Cross

**Finishes:** T  
**Shade Treatments:** NP  
**Shade Details:**  
15" x 20" x 14"

**Socket:** 2 - Pull Chain  
**Wattage:** 2 - 60 A

**Designer:**  
John Rosselli



**SP1004GI-NP**  
**Maurice Floor Lamp**  
in Gilded Iron with  
Quartz and Natural  
Paper Shade  
Height: 61"  
Width: 17"  
Base: 17" Tripod

**Finishes:** AI, GI  
**Shade Treatments:** NP  
**Shade Details:**  
16" x 17" x 12"

**Socket:** Hi-Lo  
**Wattage:** 150 A

**Designer:**  
J. Randall Powers

SP1004AI-NP



**SP1002GI-NP**  
**Ramsey Floor Lamp**  
**in Gilded Iron with**  
**Natural Paper Shade**  
Height: 65"  
Width: 20"  
Base: 17" Tripod

**Finishes:** AI, GI  
**Shade Treatments:** NP  
**Shade Details:**  
16.5" x 20" x 15"

**Socket:** Hi-Lo  
**Wattage:** 150 A

**Designer:**  
J. Randall Powers

**SP1002AI-NP**



**TOB1152GI-NP**  
**Parish Floor Lamp**  
**in Gilded Iron with**  
**Natural Paper Shade**

Height: 65.25"  
Width: 19"  
Base: 19.5" Tripod

**Finishes:** AI, GI  
**Shade Treatments:** NP  
**Shade Details:**  
15" x 19" x 16.5"

**Socket:** 2 - Pull Chain  
**Wattage:** 2 - 60 A

**Designer:**  
Thomas O'Brien

**TOB1152AI-NP**



**CHA9707GI-NP**  
**Strie Floor Lamp**  
**in Gilded Iron with**  
**Natural Paper Shade**

Height: 63"  
Width: 19"  
Base: 16" Tripod

**Finishes:** AI, GI  
**Shade Treatments:** NP  
**Shade Details:**  
14" x 19" x 12"

**Socket:** Hi-Lo  
**Wattage:** 150 A

**Designer:**  
E. F. Chapman

©EFC DESIGNS

CHA9707AI-NP

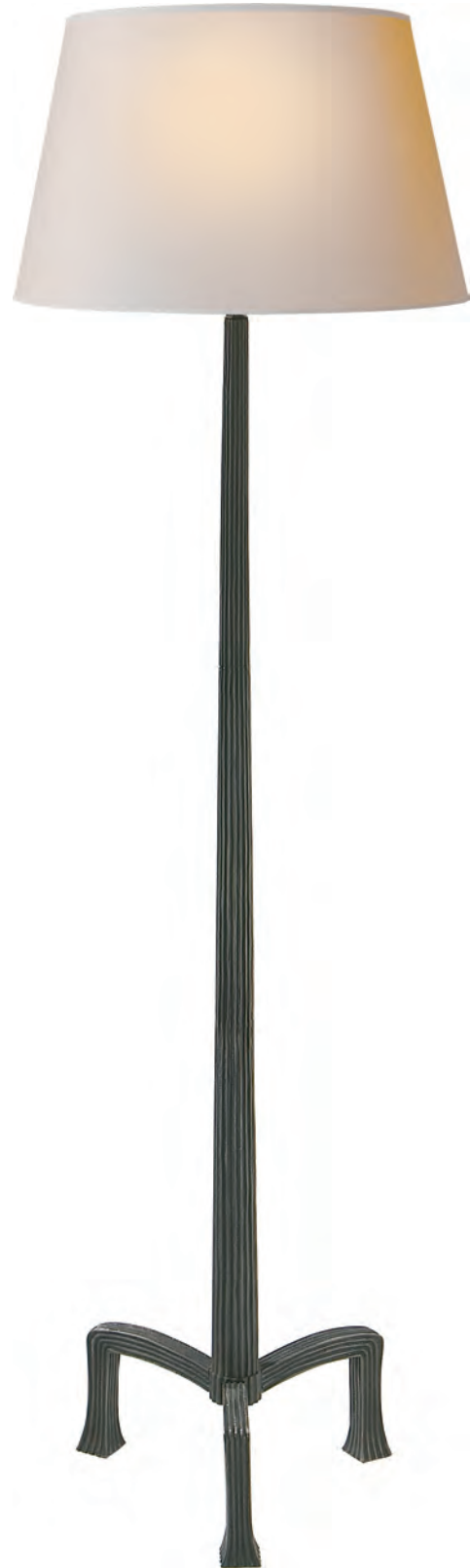



**SP1000GI-NP**  
**Lancaster Floor Lamp**  
in Gilded Iron with  
Natural Paper Shade  
Height: 64"  
Width: 23"  
Base: 15.5" Tripod

**Finishes:** AI, GI  
**Shade Treatments:** NP  
**Shade Details:**  
5" x 23" x 13"

**Socket:** Hi-Lo  
**Wattage:** 100 A

**Designer:**  
J. Randall Powers

**SP1000AI-NP**



**S1404AI-NP**  
**Outline Floor Lamp**  
in Aged Iron with  
Natural Paper  
Height: 57.25"  
Width: 15.25"  
Base: 6" x 11.5"  
Rectangle

**Finishes:** AI

**Socket:** Pull-Chain  
**Wattage:** 60 B

**Designer:**  
Ian Fowler



**CL1002AI-NP**  
**Tribeca Floor Lamp**  
in Aged Iron with  
Natural Paper Shade  
Height: 53"  
Width: 8"  
Base: 8" Square

**Finishes:** AI  
**Shade Treatments:** NP  
**Shade Details:**  
7.5" x 7.5" x 9"

**Socket:** Pull-Chain  
**Wattage:** 75 A

**Designer:**  
Clodagh





**CHA9710AI-NP**  
**Terrazo Tri-Leg**  
**Floor Lamp in**  
**Aged Iron with**  
**Natural Paper Shade**  
Height: 66"  
Width: 23"  
Base: 18.5" Tripod

**Finishes:** AI, GI  
**Shade Treatments:** NP  
**Shade Details:**  
20" x 23" x 13"

**Socket:** Pull-Chain  
**Wattage:** 150 A

**Designer:**  
E. F. Chapman

©EFC DESIGNS

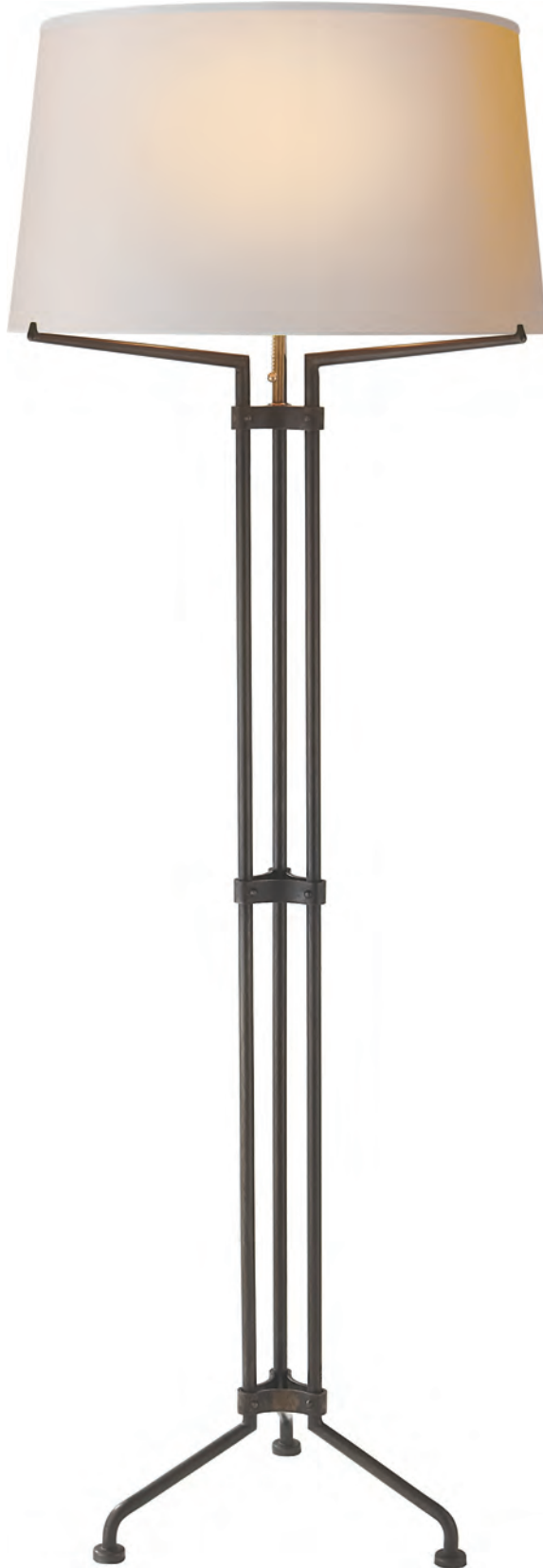

**CHA9715GI-NP**  
**Tremayne Floor Lamp**  
**in Gilded Iron with**  
**Natural Paper Shade**  
Height: 63.25"  
Width: 20"  
Base: 15.5" Tripod

**Finishes:** AI, GI  
**Shade Treatments:** NP  
**Shade Details:**  
7" x 20" x 13.75"

**Socket:** Dimmer  
**Wattage:** 100 A

**Designer:**  
E. F. Chapman

©EFC DESIGNS



**S1050GI-NP**  
**Aspen Floor Lamp**  
**in Gilded Iron with**  
**Natural Paper Shade**

Height: 59.5"

Width: 17.75"

Base: 11" x 17"

Rectangle

**Finishes:** BR, GI

**Shade Treatments:** NP

**Shade Details:**

17" x 17.75" x 9.5"

Rectangle

**Socket:** 2 - Keyless  
with In-Line Switch

**Wattage:** 2 - 60 W

**Designer:**

Ian Fowler

S1050BR-NP

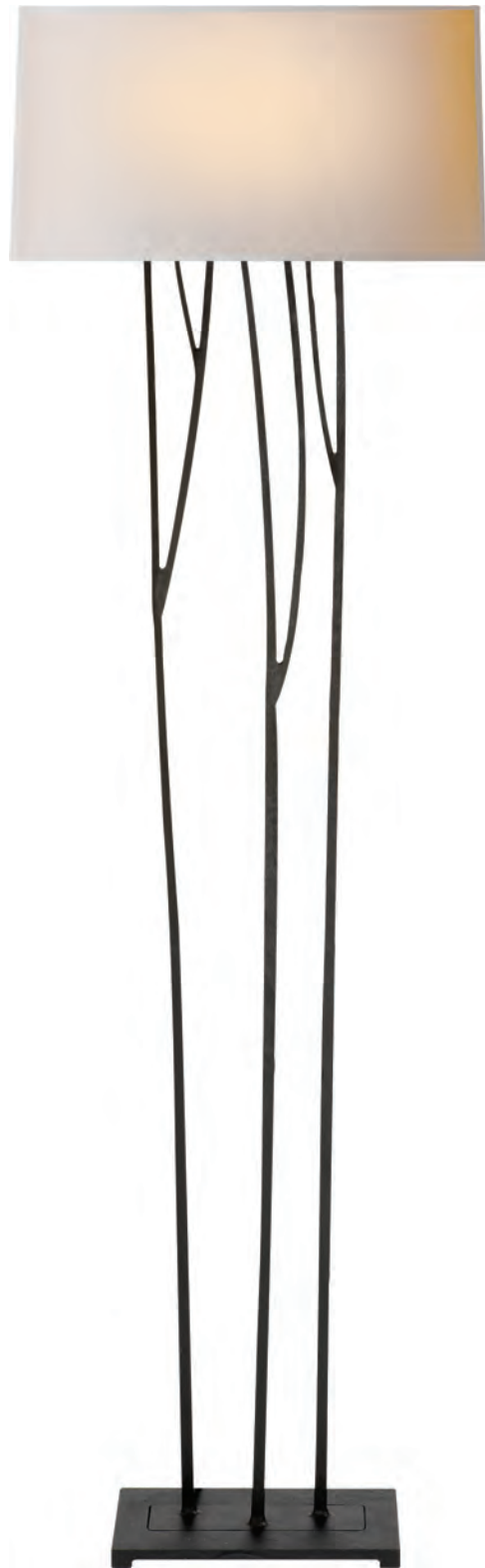

**S1052GI-NP**  
**Vail Floor Lamp**  
in Gilded Iron with  
Natural Paper Shade  
Height: 64"  
Width: 19.5  
Base: 15.75" Sculptural

**Finishes:** AI, GI  
**Shade Treatments:** NP  
**Shade Details:**  
19.5" x 19.5" x 11"  
Nordy

**Socket:**  
Keyless with  
Line Switch  
**Wattage:** 150 A

**Designer:**  
Ian Fowler

S1052AI-NP





**S1400GI-NP**  
**Dauphine Floor Lamp**  
in Gilded Iron with  
Natural Paper Shade  
Height: 54"  
Width: 18.5"  
Base: 10" Round

**Finishes:** AI, GI  
**Shade Treatments:** NP  
**Shade Details:**  
17.5" x 18.5" x 12.5"

**Socket:** Hi-Lo  
**Wattage:** 150 A

**Note:** French Wired

**Designer:**  
Studio VC

**S1400AI-NP**



**TOB1155GI-NP**  
**Hannah Floor Lamp**  
in Gilded Iron with  
Natural Paper Shade  
Height: 73"  
Width: 24.5"  
Base: 13.75" Cross

**Finishes:** AI, GI  
**Shade Treatments:** NP  
**Shade Details:**  
15.5" x 24.5" x 18"

**Socket:** 2 - Keyless  
with Pull Chain  
**Wattage:** 2 - 75 A

**Designer:**  
Thomas O'Brien

TOB1155AI-NP





**TOB1151GI-NP**  
**Ernesto Floor Lamp**  
in Gilded Iron with  
Natural Paper Shade  
Height: 69.5"  
Width: 20"  
Base: 13" Round

**Finishes:** AI, GI  
**Shade Treatments:** NP  
**Shade Details:**  
17.5" x 20" x 14" Oval

**Socket:** 2 - Pull Chain  
**Wattage:** 2 - 60 A

**Designer:**  
Thomas O'Brien

TOB1151AI-NP





**CHA9461GI-NP**  
**Fluted Spire Floor**  
**Lamp in Gilded**  
**Iron with Natural**  
**Paper Shade**  
Height: 60.5"  
Width: 19"  
Base: 6.5" Round

**CHA9461AI-NP**

**Finishes:** AI, GI  
**Shade Treatments:** NP  
**Shade Details:**  
14" x 19" x 12"

**Socket:** Dimmer  
**Wattage:** 150 A

**Designer:**  
E. F. Chapman

©EFC DESIGNS



**CHA9722BSL-NP**  
**Palm Leaf Floor Lamp**  
**in Burnished Silver Leaf**  
**on Crystal Base with**  
**Natural Paper Shade**  
Height: 63.75"  
Width: 19"  
Base: 13" Round

**Finishes:** BSL, GI  
**Shade Treatments:** NP  
**Shade Details:**  
15" x 19" x 12"

**Socket:** On - Off  
**Wattage:** 150 A

**Designer:**  
E. F. Chapman

©EFC DESIGNS

**CHA9722GI-NP**



**ARN1005PN/CG-L**  
**Riga Floor Lamp**  
**in Clear Glass and**  
**Polished Nickel**  
**with Linen Shade**  
Height: 60.25"  
Width: 20"  
Base: 12" Round

**Finishes:**  
HAB/CG, PN/CG  
**Shade Treatments:** L  
**Shade Details:**  
19.5" x 20" x 13"

**Socket:**  
2 - Pull Chain  
**Wattage:** 2 - 60 A

**Designer:**  
AERIN

**ARN1005HAB/CG-L**

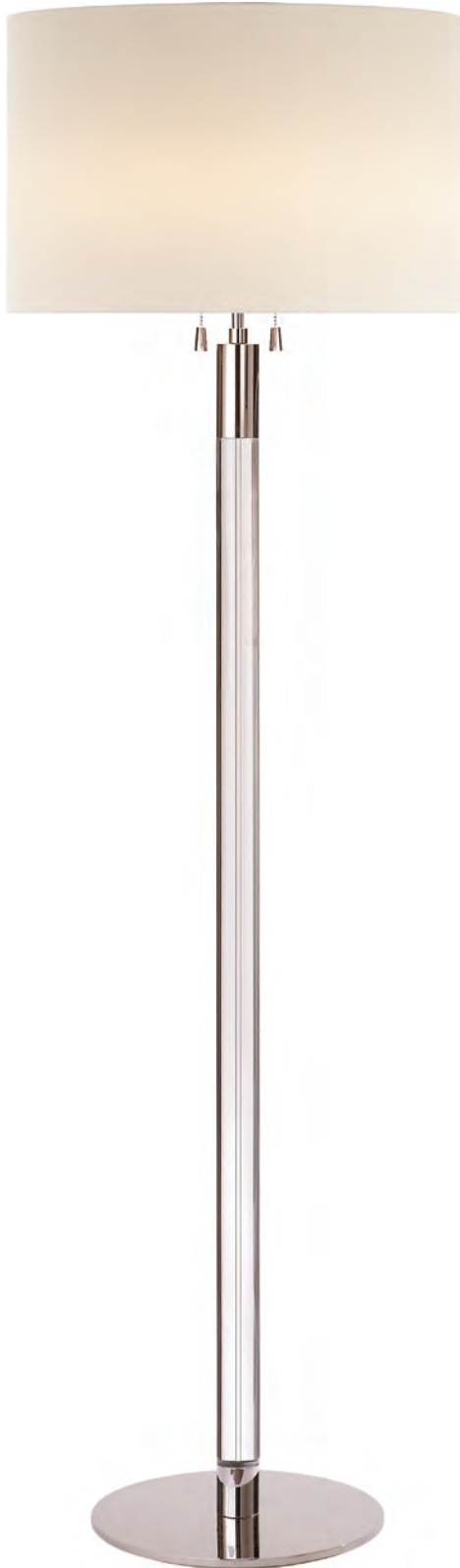

**TOB1000PN-NP**  
**Longacre Floor Lamp**  
**in Polished Nickel with**  
**Natural Paper Shade**  
Height: 64.5"  
Width: 22"  
Base: 15" Round

**TOB1000BZ-NP**

**Finishes:**  
BZ, HAB, PN  
**Shade Treatments:** NP  
**Shade Details:**  
22" x 22" x 12.5"  
**Socket:** 2 - Pull Chain  
**Wattage:** 2 - 75 A  
**Designer:**  
Thomas O'Brien



**TOB1004AN-WP/ST**  
**Hudson Floor Lamp**  
**in Antique Nickel with**  
**White Paper Shade**  
**and Silver Tape**  
Height: 60"  
Width: 22"  
Extension: 25"  
Base: 16" U-Shaped

**Finishes:**  
AN, BZ, HAB, PN  
**Shade Treatments:**  
NP/BT, WP/ST  
**Shade Details:**  
22" x 22" x 6.5"

**Socket:** 2 - Pull Chain  
**Wattage:** 2 - 60 B

**Designer:**  
Thomas O'Brien

**TOB1004BZ-NP/BT**



**SK1008BSL-L**  
Modern Open Floor  
Lamp in Burnished  
Silver Leaf with  
Linen Shade  
Height: 64"  
Width: 20"  
Base: 8" x 12"  
Rectangle

SK1008AI-L

**Finishes:** AI, BSL, G  
**Shade Treatments:** L  
**Shade Details:**  
19" x 20" x 13"  
Rectangle

**Socket:** Hi-Lo  
**Wattage:** 150 A

**Designer:**  
Suzanne Kasler



**TOB1147BSL-NP**  
**Marcus Floor Lamp**  
**in Burnished Silver**  
**Leaf with Natural**  
**Paper Shade**  
Height: 68.5"  
Width: 22"  
Base: 12.25" Square

**Finishes:** AI, BSL, G  
**Shade Treatments:** NP  
**Shade Details:**  
18" x 22" x 16.5"

**Socket:** 2 - Pull Chain  
**Wattage:** 2 - 60 A

**Designer:**  
Thomas O'Brien

**TOB1147AI-NP**



**SP1008PN-NP**  
**Empire Floor Lamp in**  
**Polished Nickel with**  
**Natural Paper Shade**

Height: 67"  
Width: 19.5"  
Base: 13" Square

**Finishes:** HAB, PN  
**Shade Treatments:** NP  
**Shade Details:**  
18.5" x 19.5" x 12"  
Rectangle

**Socket:** 2 - Pull Chain  
**Wattage:** 2 - 75 A

**Designer:**  
J. Randall Powers

**SP1008HAB-NP**





**SK1610PN-L**  
**Coral Floor Lamp**  
**in Polished Nickel**  
**with Linen Shade**  
Height: 63.5"  
Width: 15"  
Base: 7" x 10.5"  
Rectangle

**Finishes:** HAB, PN  
**Shade Treatments:** L  
**Shade Details:**  
12" x 15" x 12"

**Socket:** Dimmer  
**Wattage:** 100 A

**Designer:**  
Suzanne Kasler

**SK1610HAB-L**



**BBL1018WA-S**  
**Octagon Floor Lamp**  
**in Walnut with**  
**Silk Banded Shade**  
Height: 66"  
Width: 18"  
Base: 12" Square

**Finishes:** WA  
**Shade Treatments:** S  
**Shade Details:**  
17" x 18" x 14.75"

**Socket:** Dimmer  
**Wattage:** 150 A

**Designer:**  
Barbara Barry



**BBL1025SS-S**  
Petal Floor Lamp  
in Soft Silver with  
Smoke Mirror Base  
and Silk Shade  
Height: 58.25"  
Width: 17"  
Base: 7" x 12"  
Rectangle

**BBL1025SB-S**

**BBL1025BZ-S**

**Finishes:** BZ, SB, SS  
**Shade Treatments:** S  
**Shade Details:**  
15.75" x 17" x 14.5"

**Socket:** Dimmer  
**Wattage:** 150 A

**Designer:**  
Barbara Barry



**TOB1002PN-NP**  
**Bryant Floor Lamp in Polished Nickel with Natural Paper Shade**  
Height: 44" - 60"  
Width: 12"  
Base: 10.5" Round

**TOB1002HAB-NP**

**TOB1002BZ-NP**

**Finishes:**  
AS, BZ, HAB, PN  
**Shade Treatments:** NP  
**Shade Details:**  
11" x 12" x 12"  
**Socket:** Hi-Lo  
**Wattage:** 150 A  
**Designer:**  
Thomas O'Brien





**BBL1023SS-S**  
Simple Floor Lamp in  
Soft Silver with Silk  
Scalloped Shade  
Height: 62.5" - 80"  
Width: 19"  
Base: 12" Round

**Finishes:** BZ, SB, SS  
**Shade Treatments:** S  
**Shade Details:**  
18" x 19" x 16"

**Socket:** Dimmer  
**Wattage:** 150 A

**Designer:**  
Barbara Barry

**BBL1023SB-S**  
Silk Scalloped Shade

**BBL1023BZ-S2**  
Silk Banded Shade



**TOB1201PN-NP**  
**Paulo Floor Light in**  
**Polished Nickel with**  
**Natural Paper Shade**  
Height: 63.5"  
Width: 16"  
Base: 13" Round

**Finishes:** BZ, HAB, PN  
**Shade Treatments:** NP  
**Shade Details:**  
12" x 16" x 12"

**Socket:** Dimmer  
**Wattage:** 150 A

**Designer:**  
Thomas O'Brien

**TOB1201BZ-NP**



**SP1022PN-NP**  
**Hackney Floor**  
**Lamp in Polished**  
**Nickel with Natural**  
**Paper Shade**  
Height: 52.25"  
Width: 14"  
Base: 9" Round

**Finishes:**  
BZ, HAB, PN  
**Shade Treatments:** NP  
**Shade Details:**  
4" x 14" x 7.75"

**Socket:**  
Keyless with Line Switch  
**Wattage:** 60 B

**Designer:**  
J. Randall Powers

**SP1022HAB-NP**

**SP1022BZ-NP**

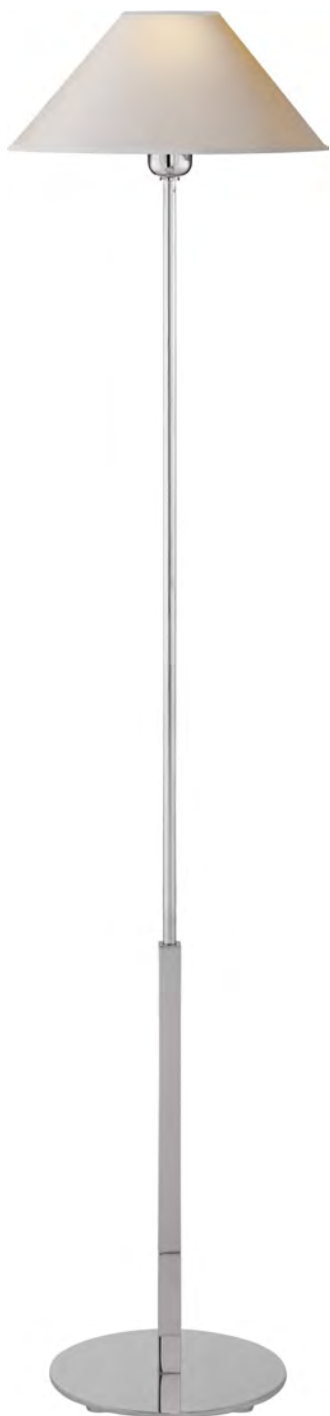



**CHA9106AB-NP**  
**Chunky Swing**  
**Arm Floor Lamp in**  
**Antique-Burnished**  
**Brass with Natural**  
**Paper Shade**  
Height: 54.5" - 70.5"  
Extension: 31"  
Base: 12.5" Round

**Finishes:**  
AB, AN, BZ, PN  
**Shade Treatments:**  
L, NP  
**Shade Details:**  
10" x 12" x 7.5"

**Socket:** Dimmer  
**Wattage:** 150 A

**Designer:**  
E.F. Chapman

©EFC DESIGNS

**CHA9106BZ-NP**



**SP1504PN-NP**  
**Hargett Floor Lamp in**  
**Polished Nickel with**  
**Natural Paper Shade**  
Height: 52" - 58.5"  
Width: 12"  
Base: 12" Round

**SP1504HAB-NP**

**SP1504BZ-NP**

**Finishes:**  
BZ, HAB, PN  
**Shade Treatments:** NP  
**Shade Details:**  
2.5" x 11.75" x 6"

**Socket:** Hi-Lo  
**Wattage:** 60 A

**Designer:**  
J. Randall Powers



**SP1505HAB-NP**  
**Hargett Bridge Arm**  
**Floor Lamp in**  
**Hand-Rubbed Antique**  
**Brass with Natural**  
**Paper Shade**  
Height: 50" - 56.5"  
Extension: 15.75"  
Base: 10" Round

**Finishes:**  
BZ, HAB, PN  
**Shade Treatments:** NP  
**Shade Details:**  
2.5" x 11.75" x 7.5"

**Socket:** Hi-Lo  
**Wattage:** 60 A

**Designer:**  
J. Randall Powers



**TOB1013PN-NP**  
**Ziyi Tension Pole**  
**Lamp in Polished**  
**Nickel with Natural**  
**Paper Shades**  
Height: 96" - 120"  
Extension: 14.5"  
Base: 2" Round

**Finishes:**  
BZ/HAB, PN  
**Shade Treatments:** NP  
**Shade Details:**  
4" x 5" x 6.5"

**Socket:** 3 - Hi-Lo  
**Wattage:** 3 - 60 A

**Note:**  
(Arms Positioned  
as Shown)

**Designer:**  
Thomas O'Brien

**TOB1013BZ/HAB-NP**



**TOB1012PN-NP**  
**Ziyi Pivoting Floor**  
**Lamp in Polished**  
**Nickel with Natural**  
**Paper Shade**  
Height: 58"  
Width: 10.5"  
Extension: 16.5"  
Base: 10.5" Round

**Finishes:**  
BZ, HAB, PN  
**Shade Treatments:** NP  
**Shade Details:**  
7.5" x 8.5" x 11"

**Socket:** Hi-Lo  
**Wattage:** 75 A

**Designer:**  
Thomas O'Brien

**TOB1012BZ-NP**



**TOB1720PN-NP**  
**Jake Adjustable Floor**  
**Lamp in Polished**  
**Nickel with Natural**  
**Paper Shade**  
Height: 48.75"-62.75"  
Width: 17"  
Base: 10.75" x 11.75"  
Rectangle

**TOB1720SN-NP**

**TOB1720HAB-NP**

**Finishes:**  
HAB, PN, SN  
**Shade Treatments:** NP  
**Shade Details:**  
17" x 17" x 10"

**Socket:** Hi-Lo  
**Wattage:** 100 A

**Designer:**  
Thomas O'Brien



**TOB1021PN-NP**  
**Mia Floor Lamp in**  
**Polished Nickel with**  
**Natural Paper Shade**  
Height: 56"  
Extension: 26.5"  
Base: 18.25" Tripod

**TOB1021GI-NP**

**TOB1021AI-NP**

**Finishes:**  
Al, GI, PN  
**Shade Treatments:** NP  
**Shade Details:**  
6" x 8" x 9"

**Socket:** Keyless  
with Foot Switch  
**Wattage:** 75 A

**Designer:**  
Thomas O'Brien







**ARN1003HAB-L**  
**Clarkson Floor Lamp**  
in Hand-Rubbed  
Antique Brass with  
Linen Shades  
Height: 58.25"  
Width: 12"  
Base: 8" x 11" Oval

ARN1003BLK-L

**Finishes:** BLK, HAB  
**Shade Treatments:** L  
**Shade Details:**  
4.5" x 5.75" x 7.5"

**Socket:** 2 - Candelabra  
with Floor Switch  
**Wattage:** 2 - 40 B

**Designer:**  
AERIN



**ARN1025BSL-L**  
**Montreuil Floor Lamp**  
**in Burnished Silver Leaf**  
**with Linen Shades**

Height: 67"  
Width: 16.75"  
Base: 10" Round

**Finishes:** BSL, G  
**Shade Treatments:** L  
**Shade Details:**  
3.5" x 6" x 8"

**Socket:** 4 - Candelabra  
with Line Switch  
**Wattage:** 4 - 40 B

**Designer:**  
AERIN

ARN1025G-L



**SK1004PN-NP**  
**Thornton Floor**  
**Lamp in Polished**  
**Nickel with Natural**  
**Paper Shade**  
Height: 53.5"  
Width: 21"  
Base: 21" Tripod

**SK1004HAB-NP**

**Finishes:** HAB, PN  
**Shade Treatments:** NP  
**Shade Details:**  
16" x 17.5" x 6.25"

**Socket:** 3 - Keyless  
with Pull Chain  
**Wattage:** 3 - 25 B

**Designer:**  
Suzanne Kasler



**TOB1010PN-NP2**  
**Studio Floor Lamp**  
**in Polished Nickel**  
**with Small Natural**  
**Paper Shade**  
 Height: 53.5" - 83"  
 Width: 20"  
 Base: 9.5" x 34.5"  
 Tripod

**Finishes:**  
 BZ, HAB, PN  
**Shade Treatments:** NP  
**Shade Details:**  
 17" x 20" x 17"

**Socket:** 2 - Pull Chain  
**Wattage:** 2 - 75 A

**Designer:**  
 Thomas O'Brien

**TOB1010HAB-NP**  
**Shade Details:**  
 25" x 28" x 22"





**TOB1153PN-NP**  
**Caron Floor Lamp in Polished Nickel with Natural Paper Shade**  
Height: 67.5"  
Width: 16"  
Base: 18" X-Shape

**TOB1153HAB-NP**

**TOB1153BZ/HAB-NP**

**Finishes:**  
BZ/HAB, HAB, PN  
**Shade Treatments:** NP  
**Shade Details:**  
16" x 16" x 17"  
Closed Top

**Socket:** 2 - Pull Chain  
**Wattage:** 2 - 60 A

**Designer:**  
Thomas O'Brien

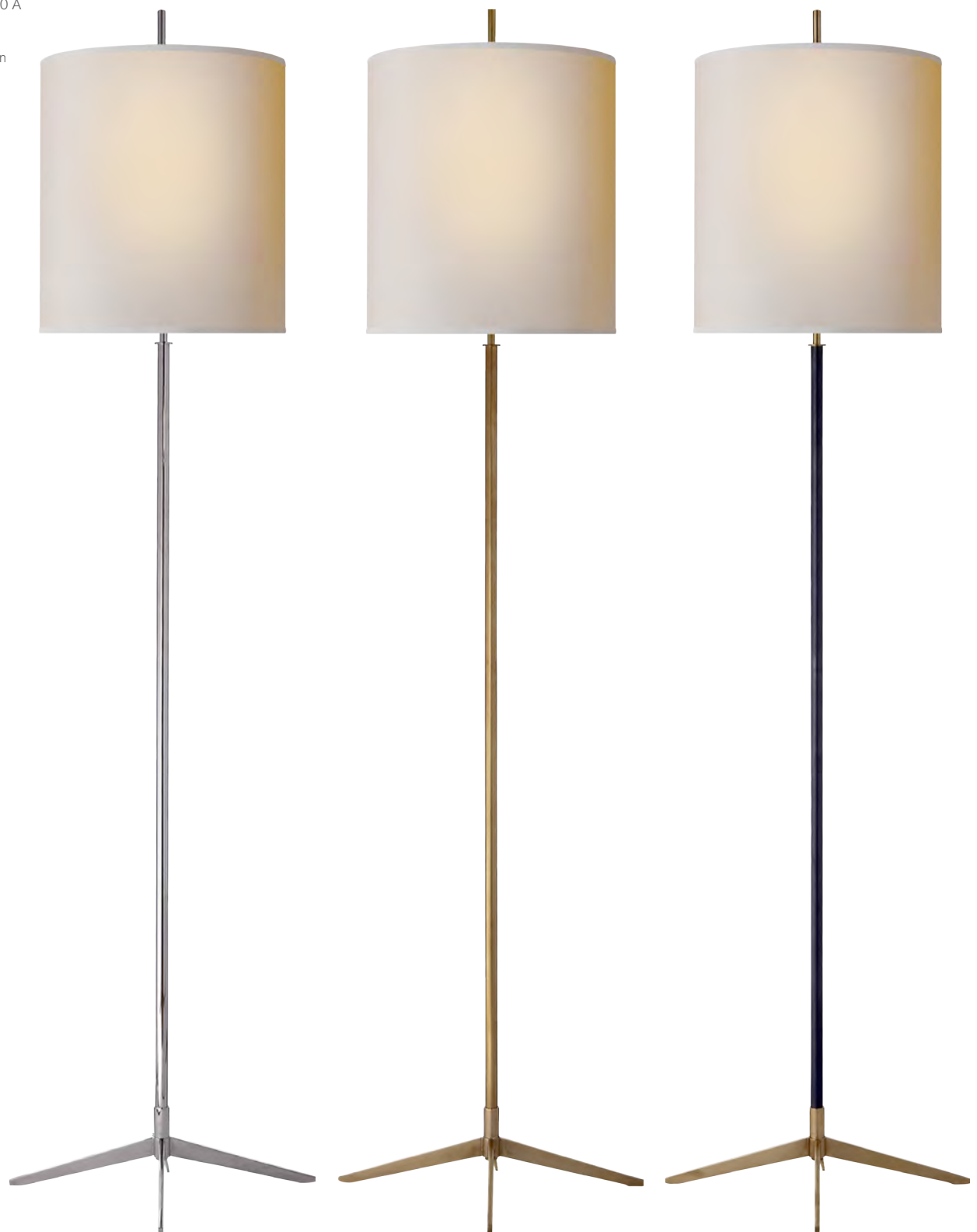

**ARN1001PN-L**  
**Frankfort Floor Lamp**  
**in Polished Nickel**  
**with Ebony Accents**  
**and Linen Shade**  
Height: 60"  
Width: 18"  
Base: 18" Tripod

**Finishes:**  
AI, HAB, PN  
**Shade Treatments:** L  
**Shade Details:**  
10.5" x 11.5" x 25"

**Socket:** Hi-Lo  
**Wattage:** 100 A

**Designer:**  
AERIN

ARN1001HAB-L

ARN1001AI-L



**S1087PN-L**  
**Diana Floor Lamp**  
**in Polished Nickel**  
**with Linen Shade**  
Height: 65"  
Width: 25"  
Base: 18" Tripod

S1087AI-L

**Finishes:** AI, PN  
**Shade Treatments:** L  
**Shade Details:**  
25" x 25" x 16"

**Socket:** Hi-Lo  
**Wattage:** 100 A

**Designer:**  
Barry Goralnick





**SC1101PN-L**  
**Paris Floor Lamp in**  
**Ebony and Polished**  
**Nickel Accent with**  
**Linen Shade**  
Height: 57.5" - 77.5"  
Width: 20"  
Base: 14" Tripod

**Finishes:** HAB, PN  
**Shade Treatments:** L  
**Shade Details:**  
20" x 20" x 11" Oval

**Socket:** 2 - Pull Chain  
**Wattage:** 2 - 75 A

**Designer:**  
Eric Cohler

**SC1101HAB-L**



**SL1700FW-NP**  
**Tripod Floor Lamp**  
**in French Wax with**  
**Natural Paper Shade**  
Height: 61"  
Width: 21"  
Base: 21" Tripod

**SL1700TB-NP**

**Finishes:** FW, TB  
**Shade Treatments:** NP  
**Shade Details:**  
20" x 20" x 11"

**Socket:** Hi-Lo  
**Wattage:** 150 A

**Designer:**  
E. F. Chapman

©EFC DESIGNS







**TOB1027BSL-NP**  
**Surveyor Floor Lamp**  
**in Burnished Silver**  
**Leaf with Natural**  
**Paper Shade**  
Height: 74"  
Width: 24"  
Base: 24" Tripod

**TOB1027SBO-NP**

**TOB1027EBO-NP**

**Finishes:**  
BSL, EBO, SBO  
**Shade Treatments:** NP  
**Shade Details:**  
15" x 16" x 17"

**Socket:** 2 - Pull Chain  
**Wattage:** 2 - 75 A

**Designer:**  
Thomas O'Brien



**S111BW-NP**  
**Bamboo Floor Lamp**  
**in Belgian White with**  
**Natural Paper Shade**  
Height: 52.5"  
Width: 17"  
Base: 9.5" Round

**S111BB-NP**

**Finishes:** BB, BW  
**Shade Treatments:** NP  
**Shade Details:**  
13" x 17" x 12"

**Socket:** Hi-Lo  
**Wattage:** 150 A

**Designer:**  
Studio VC



**SL1126BW-NP**  
**Tudor Twist Adjustable**  
**Floor Lamp in**  
**Belgian White with**  
**Natural Paper Shade**  
Height: 54" - 74"  
Width: 15"  
Base: 9.5" Round

**Finishes:** BW, WA  
**Shade Treatments:**  
L, NP  
**Shade Details:**  
9" x 15" x 9"

**Socket:** Hi-Lo  
**Wattage:** 100 A

**Designer:**  
E.F. Chapman

©EFC DESIGNS

**SL1126WA-NP**



**S1026BR-NP**  
**Georgetown Bridge**  
**Floor Lamp in Black**  
**Rust with Natural**  
**Paper Shade**  
Height: 59" - 72"  
Width: 12.5"  
Extension: 18"  
Base: 10" Round

**Finishes:** BR  
**Shade Treatments:** NP  
**Shade Details:**  
9" x 12.5" x 9.5"

**Socket:** Dimmer  
**Wattage:** 150 A

**Designer:**  
Studio VC





**S1010HAB-NP**  
**French Candlestick**  
**Floor Lamp in**  
**Hand-Rubbed Antique**  
**Brass with Natural**  
**Paper Shade**  
Height: 56"  
Width: 11"  
Base: 8" Round

**Finishes:** AN, HAB  
**Shade Treatments:**  
L, NP  
**Shade Details:**  
5" x 11" x 8.75"

**Socket:** Dimmer  
**Wattage:** 75 A

**Designer:**  
Studio VC



**S1012HAB-L**  
**French Candlestick**  
**Swing Arm Floor**  
**Lamp in Hand-Rubbed**  
**Antique Brass with**  
**Linen Shade**  
Height: 49.5" - 60.5"  
Width: 11"  
Extension: 12" - 18"  
Base: 12" Round

**Finishes:** AN, HAB  
**Shade Treatments:**  
L, NP  
**Shade Details:**  
8" x 11" x 9"

**Socket:** Dimmer  
**Wattage:** 100 A

**Designer:**  
Studio VC



**CHA9124AB-NP**  
Overseas Adjustable  
Club Floor Lamp in  
Antique-Burnished  
Brass with Natural  
Paper Shade  
Height: 47" - 64.5"  
Width: 15"  
Base: 9" Round

**Finishes:** AB  
**Shade Treatments:**  
B, NP  
**Shade Details:**  
9" x 15" x 9"

**Socket:** 2 - Pull Chain  
**Wattage:** 2 - 60 A

**Designer:**  
E. F. Chapman

©EFC DESIGNS



**CHA9125AB-S**  
Overseas Adjustable  
Club Tray Floor Lamp  
in Antique-Burnished  
Brass with Silk  
Pleated Shade  
Height: 40" - 65"  
Width: 15"  
Base: 9" Round

**Finishes:** AB  
**Shade Treatments:**  
NP, S  
**Shade Details:**  
9" x 15" x 9"

**Socket:** 2 - Pull Chain  
**Wattage:** 2 - 60 A

**Note:** Tray Height: 24"

**Designer:**  
E. F. Chapman

©EFC DESIGNS



**S1200HAB-L**  
Triple Swing Arm  
Floor Lamp in  
Hand-Rubbed  
Antique Brass with  
Linen Shade  
Height: 47" - 71"  
Width: 11"  
Extension: 22"  
Base: 10" Round

**Finishes:** AN, HAB  
**Shade Treatments:**  
L, NP  
**Shade Details:**  
7" x 11" x 8.5"

**Socket:** Dimmer  
**Wattage:** 100 A

**Designer:**  
Studio VC



**CHA9121AB-S**  
Dorchester Swing  
Arm Floor Lamp in  
Antique-Burnished  
Brass with Silk Shade  
Height: 51" - 64"  
Extension: 21"  
Base: 9" Round

**Finishes:** AB  
**Shade Treatments:**  
B, S  
**Shade Details:**  
6" x 12" x 8.5"

**Socket:** Hi-Lo  
**Wattage:** 75 A

**Designer:**  
E. F. Chapman

©EFC DESIGNS



**FUNCTIONAL FLOOR**



**ARN1006BLK**  
**Charlton Floor Lamp**  
**in Black and Hand-**  
**Rubbed Antique Brass**

Height: 51" - 63"  
Width: 12"  
Extension: 42"  
Base: 12" Round

**Finishes:** BLK, WHT

**Socket:** Keyless  
with Floor Switch  
**Wattage:** 60 A

**Designer:**  
AERIN

ARN1006WHT



**ARN1010HAB-BLK**  
**Clemente Floor Lamp in**  
**Hand-Rubbed Antique**  
**Brass with Black**  
Height: 47.25" - 59.25"  
Width: 10.5"  
Extension: 17.5"  
Base: 10.5" Round

**Finishes:** HAB  
**Shade Treatments:**  
BLK, HAB, WHT

**Socket:** Keyless  
with Foot Switch  
**Wattage:** 60 A

**Designer:**  
AERIN

ARN1010HAB-WHT

ARN1010HAB-HAB



**ARN1014HAB-WHT**  
**Moresby Floor Lamp**  
**in Hand-Rubbed**  
**Antique Brass with**  
**White Shade**

Height: 56"  
Width: 13"  
Extension: 23"  
Base: 18.75" Tripod

**Finishes:** HAB  
**Shade Treatments:**  
HAB, WHT

**Socket:** Dimmer  
**Wattage:** 60 A

**Designer:**  
AERIN

ARN1014HAB-HAB





**KW1088BZ/AB**  
**Cleo Floor Lamp**  
in Bronze and  
Antique-Burnished  
Brass with Antique  
White Shade  
Height: 60"  
Width: 29.25"  
Base: 10" Square

**Finishes:** BZ/AB

**Socket:**  
Keyless with  
Line Switch  
**Wattage:** 100 A

**Designer:**  
Kelly Wearstler



**ARN1007HAB-HAB**  
**Sommerard Floor**  
**Lamp in Hand-Rubbed**  
**Antique Brass**  
Height: 41" - 52"  
Width: 16"  
Extension: 20"  
Base: 19" Tripod

ARN1007HAB-BLK

ARN1007HAB-WHT

**Finishes:** HAB  
**Shade Treatments:**  
BLK, HAB, WHT

**Socket:** Keyless  
with Foot Switch  
**Wattage:** 60 A

**Designer:**  
AERIN



**ARN1009HAB-WHT**  
**Sommerard Triple Arm**  
**Floor Lamp in**  
**Hand-Rubbed Antique**  
**Brass with White**  
Height: 60" - 82"  
Extension: 20" - 40"  
Base: 22"

**Finishes:** HAB  
**Shade Treatments:**  
BLK, WHT

**Socket:**  
3 -Keyless with  
Foot Switch  
**Wattage:** 3 - 60 A

**Designer:**  
AERIN





**91025PN**  
**Studio Adjustable**  
**Floor Lamp in**  
**Polished Nickel**  
Height: 34" - 45"  
Extension: 13"  
Base: 6" x 9"  
Rectangle

**91025AN**

**91025BZ**

**91025HAB**

**Finishes:**  
AN, BZ, HAB, PN

**Socket:** Dimmer  
**Wattage:** 60 T

**Designer:**  
Studio VC



**81134HAB**  
**Studio Swing Arm**  
**Floor Lamp in**  
**Hand-Rubbed**  
**Antique Brass**  
Height: 43" - 57"  
Extension: 20"  
Base: 6" x 9"  
Rectangle

**81134AN**

**81134BZ**

**81134PN**

**Finishes:**  
AN, BZ, HAB, PN

**Socket:** Dimmer  
**Wattage:** 40 J

**Note:** Bulb Included

**Designer:**  
Studio VC



**SP1508PN**  
**William Pharmacy**  
**Floor Lamp in**  
**Polished Nickel**  
Height: 33" - 41.25"  
Width: 11"  
Extension: 15"  
Base: 11" x 13.5"

**SP1508HAB**

**SP1508BZ**

**Finishes:**  
BZ, HAB, PN

**Socket:** Dimmer  
**Wattage:** 40 T

**Designer:**  
J. Randall Powers



**TOB1200PN**  
**Pask Pharmacy**  
**Floor Lamp in**  
**Polished Nickel**

Height: 37.5" - 59.5"  
Extension: 16.5"  
Base: 6" x 9"  
Rectangle

**Finishes:**  
BZ, HAB, PN

**Socket:** Dimmer  
**Wattage:** 60 T

**Designer:**  
Thomas O'Brien

TOB1200HAB







**TOB1001PN**  
**Greenwich Floor Lamp**  
**in Polished Nickel**  
Height: 42" - 54"  
Extension: 17"  
Base: 12" Round

**Finishes:**  
BC, BZ, HAB, PN

**Socket:** Dimmer  
**Wattage:** 60 T

**Designer:**  
Thomas O'Brien

**TOB1001BZ**

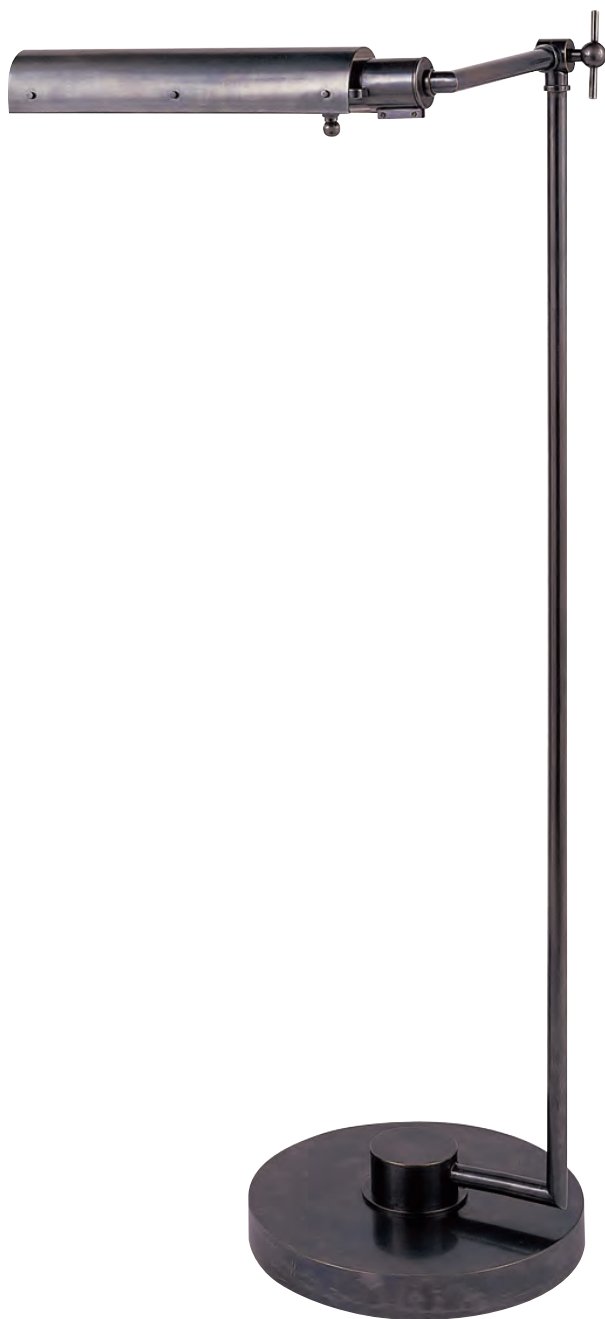

**TOB1015PN**  
**Studio Pivoting Task**  
**Floor Lamp in**  
**Polished Nickel**  
Height: 43.5" - 86"  
Extension: 53"  
Base: 20" Tripod

**TOB1015BZ**

**Finishes:**  
AN, BZ, HAB, PN

**Socket:**  
Keyless with  
Floor Dimmer  
**Wattage:** 75 A

**Designer:**  
Thomas O'Brien



**CHA9161AB**  
**Apothecary Floor**  
**Lamp in Antique-**  
**Burnished Brass**  
 Height: 40" - 54"  
 Extension: 18"  
 Base: 10" Round

**Finishes:**  
 AB, AN, BZ, PN, SN  
**Shade Details:**  
 6" Round

**Socket:** Hi-Lo  
**Wattage:** 60 A

**Designer:**  
 E. F. Chapman

©EFC DESIGNS

**CHA9161BZ**

**SL1900HAB/SLG-HAB**  
**Boston Floor Lamp**  
**in Hand-Rubbed**  
**Antique Brass with**  
**SLG Shade**  
 Height: 35" - 57"  
 Extension: 17"  
 Base: 10" Round

**Finishes:**  
 BZ, HAB, PN  
**Shade Details:**  
 2" x 6.25" x 4.5"

**Socket:** Hi-Lo  
**Wattage:** 60 A

**Designer:**  
 E. F. Chapman

©EFC DESIGNS

**SL1900BZ/SLG-BZ**



**S1100PN**  
**Old Pharmacy**  
**Floor Lamp in**  
**Polished Nickel**  
Height: 36" - 54"  
Extension: 15"  
Base: 10" Round

**Finishes:**  
AN, BZ, HAB, PN  
**Shade Details:**  
6" Round

**Socket:** Hi-Lo  
**Wattage:** 60 A

**Designer:**  
Studio VC

**S1100HAB**

**S1100BZ**



**CHA9107AN**  
**Dorchester Swing Arm**  
**Pharmacy Floor Lamp**  
**in Antique Nickel**  
Height: 37" - 63"  
Extension: 22"  
Base: 9" Round

CHA9107AB

**Finishes:**  
AB, AN, PN  
**Shade Details:**  
8.75" x 3.5" x 2"

**Socket:** Hi-Lo  
**Wattage:** 40 T

**Designer:**  
E. F. Chapman

©EFC DESIGNS



**SL1031HAB**  
**Architect's Mini**  
**Double Floor Lamp**  
**in Hand-Rubbed**  
**Antique Brass**  
Height: 35" - 64.5"  
Width: 8"  
Extension: 28"  
Base: 8" Square

**SL1031BZ**

**Finishes:**  
BZ, HAB, PS  
**Shade Details:**  
2" x 6.25" x 4.5"

**Socket:** Hi-Lo  
**Wattage:** 40 B or Par

**Designer:**  
E. F. Chapman

©EFC DESIGNS



**ARN1004G**  
**Bedford Floor**  
**Lamp in Gild**  
Height: 79"  
Width: 14"  
Base: 14" Triangle

**Finishes:**  
BSL, G, PW

**Socket:** Keyless  
with Floor Switch  
**Wattage:** 75 A

**Designer:**  
AERIN





**KW1060BZ**  
**Precision Floor**  
**Lamp in Bronze**  
**with Frosted Glass**  
Height: 59"  
Width: 9"  
Base: 9" Round

**KW1060AB**

**KW1060PN**

**Finishes:**  
AB, BZ, PN

**Socket:** Keyless  
with Dimmer  
**Wattage:** 60 T

**Designer:**  
Kelly Wearstler



**CEILING**



CHANDELIER 284  
HANGING SHADES 414  
PENDANTS 422  
LINEAR 484  
LANTERNS 506  
FLUSH MOUNTS 578

# CHANDELIER CEILING

ARN5105PN-CG



**ARN5120PN-CG**  
**Sanger Large Chandelier**  
in Polished Nickel  
with Crystal  
Fixture Height: 21"  
Width: 36.75"  
Canopy: 5.5" Round

**Finishes:** PN  
**Trim Options:** CG

**Socket:**  
18 - Candelabra  
**Wattage:** 18 - 60 C

**Designer:**  
AERIN



**ARN5105PN-CG**  
**Sanger Small Chandelier**  
in Polished Nickel  
with Crystal  
Height: 19"  
Width: 29"  
Canopy: 5.5" Round

**Finishes:** PN  
**Trim Options:** CG

**Socket:**  
12 - Candelabra  
**Wattage:** 12 - 60 C

**Designer:**  
AERIN



**ARN5124PN-CG**  
**Bonnington Chandelier**  
**in Polished Nickel**  
**with Crystal**  
Height: 15.25"  
Width: 24.25"  
Canopy: 6" Octagon

**Finishes:** HAB, PN  
**Trim Options:** CG

**Socket:**  
12 - Candelabra  
**Wattage:** 12 - 60 C

**Designer:**  
AERIN

**ARN5124HAB-CG**







**SR5110HAB-CG**  
**Mia Small Pendant**  
**in Clear Glass**  
Fixture Height: 21.75"  
Width: 14"  
Canopy: 5.75" Round

**Finishes:** HAB  
**Trim Options:** CG

**Socket:**  
5 - Candelabra  
**Wattage:** 5 - 40 B

**Designer:**  
John Rosselli



**SR5111HAB-CG**  
**Mia Large Pendant**  
**in Clear Glass**  
Fixture Height: 37"  
Width: 24"  
Canopy: 5.75" Round

**Finishes:** HAB  
**Trim Options:** CG

**Socket:**  
5 - Candelabra  
**Wattage:** 5 - 40 B

**Designer:**  
John Rosselli



**ARN5148BSL-CG**  
**Emile Pendant in**  
**Burnished Silver Leaf**  
**with Crystal**  
Height: 19.5"  
Width: 15.5"  
Canopy: 5" Hexagon

**Finishes:** BSL, G

**Socket:**  
5 - Candelabra  
**Wattage:** 5 - 60 B

**Designer:**  
AERIN

**ARN5148G-CG**



**ARN5172G-CG**  
**Emile Large Pendant**  
**in Gild with Crystal**  
Height: 26.25"  
Width: 22.75"  
Canopy: 5" Hexagon

**Finishes:** G

**Socket:**  
12 - Candelabra  
**Wattage:** 5 - 40 C

**Designer:**  
AERIN



**KW5091AB/Q**  
**Halcyon Large Pendant**  
in Antique-Burnished  
Brass and Quartz  
Fixture Height: 31.25"  
Width: 34"  
Canopy: 4" Round

**Finishes:** AB

**Socket:**  
8 - Keyless  
**Wattage:** 8 - 60 C

**Designer:**  
Kelly Wearstler



**KW5095AB/Q**  
**Halcyon Medium**  
Round Chandelier in  
Antique-Burnished  
Brass and Quartz  
Height: 49"  
Width: 20"  
Canopy: 20.5" Round

**Finishes:** AB

**Socket:**  
6 - Candelabra  
**Wattage:** 6 - 60 C

**Designer:**  
Kelly Wearstler



**KW5012AB/Q**  
**Halcyon Large**  
**Chandelier in**  
**Antique-Burnished**  
**Brass with Quartz**  
Fixture Height: 49"  
Width: 36"  
Canopy: 4.5" Round

**Finishes:** AB

**Socket:** 6 - Keyless  
**Wattage:** 6 - 60 C

**Designer:**  
Kelly Wearstler



**KW5098AB/Q**  
**Halcyon Large Linear**  
**in Antique-Burnished**  
**Brass with Quartz**  
Fixture Height: 21.5"  
Width: 43"  
Canopy: 8" x 37.5"  
Rectangle

**Finishes:** AB

**Socket:**  
12 - Keyless  
**Wattage:** 12 - 60 C

**Designer:**  
Kelly Wearstler





**ARN5102BSL-WG**  
**Jacqueline Chandelier**  
**in Burnished Silver**  
**Leaf with White Acrylic**  
Height: 35"  
Width: 19"  
Canopy: 5.25" Round

**Finishes:** BSL, HAB  
**Trim Options:** CG, WG

**Socket:**  
4 - Candelabra  
**Wattage:** 4 - 60 C

**Designer:**  
AERIN



**ARN5102HAB-WG**



**ARN5103BSL-CG**  
**Jacqueline Long**  
**Chandelier in**  
**Burnished Silver Leaf**  
**with Clear Glass**  
Fixture Height: 39.25"  
Width: 17.25"  
Canopy: 7" Round

**Finishes:** BSL, HAB  
**Trim Options:** CG, WG

**Socket:**  
9 - Candelabra  
**Wattage:** 9 - 60 C

**Designer:**  
AERIN



**ARN5103HAB-CG**



**ARN5104BSL-WG**  
Jacqueline Two-Tier  
Chandelier in  
Burnished Silver Leaf  
with White Acrylic  
Fixture Height: 38"  
Width: 32.25"  
Canopy: 7" Round

**Finishes:** BSL, HAB  
**Trim Options:** CG, WG

**Socket:**  
12 - Candelabra  
**Wattage:** 12 - 60 C

**Designer:**  
AERIN



**ARN5104HAB-WG**



**ARN5104BSL-CG**



**ARN5104HAB-CG**





**NW5051GI**  
**Calais 34" Chandelier**  
in Gilded Iron  
Fixture Height: 34"  
Width: 34"  
Canopy: 5" Round

**Finishes:** BSL, GI  
**Trim Options:** CG

**Socket:** 6 - Candelabra  
**Wattage:** 6 - 60 C

**Designer:**  
Niermann Weeks



**ARN5170BSL-CG**  
**Lesina Chandelier in**  
**Burnished Silver Leaf**  
**with Crystal**  
Height: 31.25"  
Width: 30.75"  
Canopy: 6.75" Round

**Finishes:** BSL, G  
**Glass Options:** CG

**Socket:** 16 - Keyless  
**Wattage:** 16 - 40 G

**Designer:**  
AERIN



**ARN5170G-CG**



**ARN5173PN-CG**  
**Liscia Chandelier**  
**in Polished Nickel**  
**with Crystal**  
Height: 17.75"  
Width: 25"  
Canopy: 5" Round

**Finishes:** G, PN  
**Glass Options:** CG

**Socket:**  
12 - Candelabra  
**Wattage:** 12 - 40 C

**Designer:**  
AERIN



**ARN5173G-CG**



ARN5106HAB  
Heather Chandelier in  
Hand-Rubbed Antique  
Brass with Clear,  
Amber, and  
Amethyst Glass  
Height: 39"  
Width: 24"  
Canopy: 8" Round

**Finishes:** HAB, PN  
**Trim Options:**  
AMB, BLU, CG

**Socket:**  
4 - Candelabra  
**Wattage:** 4 - 60 C

**Designer:**  
AERIN



**ARN5126HAB-CG**  
**Heather Small Pendant**  
in Hand-Rubbed  
Antique Brass with  
Clear Glass  
Height: 28.75"  
Width: 19.25"  
Canopy: 8" Round

**Finishes:** HAB, PN  
**Glass Options:** CG

**Socket:**  
3 - Candelabra  
**Wattage:** 3 - 60 C

**Designer:**  
AERIN



**ARN5126PN-CG**



**ARN5106HAB-CG**  
**Heather Pendant**  
in Hand-Rubbed  
Antique Brass with  
Clear Glass  
Height: 39"  
Width: 24"  
Canopy: 8" Round

**Finishes:** HAB, PN  
**Glass Options:** CG

**Socket:**  
4 - Candelabra  
**Wattage:** 4 - 60 C

**Designer:**  
AERIN



**ARN5106PN-CG**



**ARN5220BSL-CG**  
**Claret Short Pendant**  
**in Burnished Silver**  
**Leaf with Crystal**  
 Height: 21.5"  
 Width: 27.5"  
 Canopy: 6" Decorative

**Finishes:** BSL, G  
**Glass Options:** CG

**Socket:**  
 12 - Candelabra  
**Wattage:** 12 - 40 C

**Designer:**  
 AERIN



ARN5220G-CG



**ARN5221BSL-CG**  
**Claret Tall Pendant**  
**in Burnished Silver**  
**Leaf with Crystal**  
 Height: 33.5"  
 Width: 24"  
 Canopy: 6" Decorative

**Finishes:** BSL, G  
**Glass Options:** CG

**Socket:**  
 12 - Candelabra  
**Wattage:** 12 - 40 C

**Designer:**  
 AERIN



ARN5221G-CG



**ARN5160BSL**  
Lynn Small Pendant in  
Burnished Silver Leaf  
with Clear Glass  
Height: 18.5"  
Width: 16.5"  
Canopy: 4.5" Round

**Finishes:** BSL, HAB  
**Trim Options:** CG

**Socket:** 11 - Keyless  
**Wattage:** 11 - 60 G

**Designer:**  
AERIN



**ARN5160HAB**



**ARN5161BSL**  
Lynn Large Pendant in  
Burnished Silver Leaf  
with Clear Glass  
Height: 25.75"  
Width: 24"  
Canopy: 4.5" Round

**Finishes:** BSL, HAB  
**Trim Options:** CG

**Socket:** 16 - Keyless  
**Wattage:** 16 - 60 G

**Designer:**  
AERIN



**ARN5161HAB**



**ARN5100BSL-CG**  
**Renwick Small**  
**Sphere Pendant in**  
**Burnished Silver Leaf**  
**with Crystal**  
Height: 21.5"  
Width: 19"  
Canopy: 6.75" Round

**Finishes:** BSL, G  
**Trim Options:** CG

**Socket:**  
4 - Candelabra  
**Wattage:** 4 - 60 C

**Designer:**  
AERIN



**ARN5100G-CG**



**ARN5101BSL-CG**  
**Renwick Large**  
**Sphere Pendant in**  
**Burnished Silver Leaf**  
**with Crystal**  
Fixture Height: 27.5"  
Width: 23.25"  
Canopy: 6.75" Round

**Finishes:** BSL, G  
**Trim Options:** CG

**Socket:**  
4 - Candelabra  
**Wattage:** 4 - 60 C

**Designer:**  
AERIN



**ARN5101G-CG**









**CHC5130PN**  
**Crystal Cube**  
**Spherical Pendant**  
**in Polished Nickel**  
Height: 22.25"  
Width: 19.25"  
Canopy: 5.75"  
Hexagon

**Finishes:**  
AB, BW, PN

**Socket:**  
6 - Candelabra  
**Wattage:** 6 - 60 C

**Designer:**  
E. F. Chapman

©EFC DESIGNS

CHC5130AB



**CHC1534PN-NP**  
**Crystal Cube Basket**  
**Chandelier in Polished**  
**Nickel with Natural**  
**Paper Shades**  
Height: 35.5"  
Width: 29.25"  
Canopy: 5.75" Square

**Finishes:** AB, PN  
**Shade Treatments:** NP  
**Shade Details:**  
3" x 4" x 5"

**Socket:**  
6 - Candelabra  
**Wattage:** 6 - 40 B

**Designer:**  
E. F. Chapman

©EFC DESIGNS

CHC1534AB-NP



**CHC1535PN**  
**Crystal Cube Round**  
**Flatline Chandelier in**  
**Polished Nickel**  
 Height: 25.25"  
 Width: 30"  
 Canopy: 5.75" Square

CHC1535AB

**Finishes:** AB, PN

**Socket:**  
 6 - Candelabra  
**Wattage:** 6 - 60 C

**Designer:**  
 E. F. Chapman

©EFC DESIGNS



**CHC1536PN**  
**Crystal Cube Oval**  
**Flatline Chandelier in**  
**Polished Nickel**  
 Height: 26"  
 Width: 20" x 33" Oval  
 Canopy: 5.75" Square

CHC1536AB

**Finishes:** AB, PN

**Socket:**  
 6 - Candelabra  
**Wattage:** 6 - 60 C

**Designer:**  
 E. F. Chapman

©EFC DESIGNS



**CHC1530PN-NP**  
**Crystal Cube Large**  
**Chandelier in Polished**  
**Nickel with Natural**  
**Paper Shades**  
Height: 37"  
Width: 34.5"  
Canopy: 5.75" Square

**Finishes:** AB, PN  
**Shade Treatments:** NP  
**Shade Details:**  
3" x 5" x 5.25"

**Socket:**  
6 - Candelabra  
**Wattage:** 6 - 40 B

**Designer:**  
E. F. Chapman

©EFC DESIGNS



**CHC1154CG/PN**  
**George II Large**  
**Chandelier in Crystal**  
**with Polished Nickel**  
Height: 31"  
Width: 30"  
Canopy: 5.5" Round

**Finishes:** CG/PN, Q

**Socket:**  
6 - Candelabra  
**Wattage:** 6 - 60 C

**Note:**  
Assembly Required

**Designer:**  
E. F. Chapman

©EFC DESIGNS



**CHC1156CG/PN**  
**George II Mini**  
**Chandelier in Crystal**  
**with Polished Nickel**  
Height: 14"  
Min. Custom Height: 21"  
Width: 13.75"  
Canopy: 5.5" Round

**Finishes:** CG/PN

**Socket:**  
6 - Candelabra  
**Wattage:** 6 - 60 C

**Note:**  
Assembly Required

**Designer:**  
E. F. Chapman

©EFC DESIGNS



**CHC1155CG/PN**  
**George II Small**  
**Chandelier in Crystal**  
**with Polished Nickel**  
Height: 23.5"  
Width: 22"  
Canopy: 5.5" Round

**Finishes:** CG/PN, Q

**Socket:**  
6 - Candelabra  
**Wattage:** 6 - 60 C

**Note:**  
Assembly Required

**Designer:**  
E. F. Chapman

©EFC DESIGNS



**CHC1152CG/PN**  
**George II Large**  
**Faceted Chandelier**  
**in Crystal with**  
**Polished Nickel**  
Height: 31"  
Width: 30"  
Canopy: 5.5" Round

**Finishes:** CG/PN

**Socket:**  
6 - Candelabra  
**Wattage:** 6 - 60 C

**Note:**  
Assembly Required

**Designer:**  
E. F. Chapman

©EFC DESIGNS



**CHC1144CG/PN**  
**King George Grande**  
**Round Chandelier**  
**in Crystal with**  
**Polished Nickel**  
 Height: 41"  
 Width: 36"  
 Canopy: 5.5" Round

**Finishes:** CG/PN

**Socket:**  
 8 - Candelabra  
**Wattage:** 8 - 60 C

**Note:**  
 Assembly Required

**Designer:**  
 E. F. Chapman

©EFC DESIGNS



**CHC1143CG/PN**  
**King George Grande**  
**Balustrade Chandelier**  
**in Crystal with**  
**Polished Nickel**  
 Height: 33"  
 Width: 36"  
 Canopy: 5.5" Round

**Finishes:** CG/PN

**Socket:**  
 8 - Candelabra  
**Wattage:** 8 - 60 C

**Note:**  
 Assembly Required

**Designer:**  
 E. F. Chapman

©EFC DESIGNS





**CHC1180CG/PN-PL**  
**Bennett Six Arm**  
**Chandelier in Crystal**  
**and Polished Nickel**  
**with Natural**  
**Percalé Shades**  
Fixture Height: 24.75"  
Width: 28.25"  
Canopy: 6.5" Octagon

**Finishes:** CG/PN  
**Shade Treatments:** PL  
**Shade Details:**  
4.5" x 5.5" x 5.5"

**Socket:**  
6 - Candelabra  
**Wattage:** 6 - 40 B

**Note:**  
Assembly Required

**Designer:**  
E. F. Chapman

©EFC DESIGNS





**CHC1526PN-NP**  
Crystal Stacked Ball  
Pendant in Polished  
Nickel and Crystal with  
Natural Paper Shade  
Height: 28.5"  
Width: 30"  
Canopy: 6.25" Round

**Finishes:** AB, PN  
**Shade Treatments:** NP  
**Shade Details:**  
24" x 30" x 14"

**Socket:**  
6 - Candelabra  
**Wattage:** 6 - 60 C

**Note:**  
Assembly Required/  
Crystal Ball Optional

**Designer:**  
E. F. Chapman

©EFC DESIGNS



CHC1526AB-NP



**CHC1525PN**  
Crystal Stacked Ball  
Pendant in Polished  
Nickel and Crystal  
Height: 29.5"  
Width: 31"  
Canopy: 6.25" Round

**Finishes:** AB, PN

**Socket:**  
6 - Candelabra  
**Wattage:** 6 - 60 B

**Note:**  
Assembly Required

**Designer:**  
E. F. Chapman

©EFC DESIGNS



CHC1525AB



**TOB5031PN-NP**  
**Vivian Mini Chandelier**  
 in Polished Nickel  
 with Natural  
 Paper Shades  
 Height: 14"  
 Width: 18.5"  
 Canopy: 6" Round

**Finishes:** HAB, PN  
**Shade Treatments:** NP  
**Shade Details:**  
 3.5" x 4" x 5.5"

**Socket:**  
 4 - Candelabra  
**Wattage:** 4 - 40 B

**Note:**  
 Assembly Required

**Designer:**  
 Thomas O'Brien



TOB5031HAB-NP



**TOB5032PN-NP**  
**Vivian Large One-Tier**  
**Chandelier in Polished**  
**Nickel with Natural**  
**Paper Shades**  
 Height: 25"  
 Width: 36"  
 Canopy: 6" Round

**Finishes:** HAB, PN  
**Shade Treatments:** NP  
**Shade Details:**  
 3.25" x 4" x 4.25"

**Socket:**  
 8 - Candelabra  
**Wattage:** 8 - 40 B

**Note:**  
 Assembly Required

**Designer:**  
 Thomas O'Brien



TOB5032HAB-NP



**TOB5033HAB-NP**  
**Vivian Large Two-Tier**  
**Chandelier in**  
**Hand-Rubbed Antique**  
**Brass with Natural**  
**Paper Shades**  
Height: 25"  
Width: 36"  
Canopy: 6" Round

**Finishes:** HAB, PN  
**Shade Treatments:** NP  
**Shade Details:**  
3.25" x 4" x 4.25"

**Socket:**  
12 - Candelabra  
**Wattage:** 12 - 40 B

**Note:**  
Assembly Required

**Designer:**  
Thomas O'Brien



**CHC1139PN**  
**Robinson Small**  
**Chandelier in**  
**Polished Nickel**  
**and Clear Glass**  
 Height: 19.25"  
 Width: 18"  
 Canopy: 5.5" Round

**Finishes:** AB, PN

**Socket:**  
 6 - Keyless  
**Wattage:** 6 - 25 C

**Designer:**  
 E. F. Chapman

©EFC DESIGNS



**CHC1140AB**  
**Robinson Medium**  
**Chandelier in**  
**Antique-Burnished**  
**Brass and Clear Glass**  
 Fixture Height: 30.25"  
 Width: 32"  
 Canopy: 5.5" Round

**Finishes:** AB, PN

**Socket:**  
 6 - Candelabra  
**Wattage:** 6 - 60 C

**Designer:**  
 E. F. Chapman

©EFC DESIGNS



**CHC1141AB**  
**Robinson Large**  
**Chandelier in**  
**Antique-Burnished**  
**Brass and Clear Glass**  
 Height: 35.75"  
 Width: 38"  
 Canopy: 5.5" Round

**Finishes:** AB, PN

**Socket:** 6 - Keyless  
**Wattage:** 6 - 60 C

**Designer:**  
 E. F. Chapman

©EFC DESIGNS



**ARN5116HAB-CG**  
**Wharton Chandelier**  
in Clear Acrylic  
and Hand-Rubbed  
Antique Brass  
Fixture Height: 31"  
Width: 37.75"  
Canopy: 4.5" Round

**Finishes:** HAB  
**Trim Options:** CG

**Socket:**  
15 - Candelabra  
**Wattage:** 15 - 60 C

**Designer:**  
AERIN







**SN5107SN**  
**Regency Medium**  
**Chandelier in**  
**Sheffield Nickel**  
**with Seeded Glass**  
 Height: 30.75"  
 Width: 22"  
 Canopy: 4.5" Round

**Finishes:**  
 HAB, PN, SN  
**Trim Options:** CG

**Socket:**  
 6 - Candelabra  
**Wattage:** 6 - 60 C

**Designer:**  
 Joe Nye



SN5107HAB



**SN5108PN**  
**Regency Large**  
**Chandelier in**  
**Polished Nickel**  
**with Seeded Glass**  
 Fixture Height: 33.5"  
 Width: 31"  
 Canopy: 4.5" Round

**Finishes:**  
 HAB, PN, SN  
**Trim Options:** SG

**Socket:**  
 8 - Candelabra  
**Wattage:** 8 - 60 C

**Designer:**  
 Joe Nye



SN5108HAB



**CHC1547SN**  
**Belvoir Medium**  
**Chandelier in**  
**Sheffield Nickel**  
**with Crystal**  
Height: 36"  
Width: 35.25"  
Canopy: 5.5" Round

**Finishes:** AB, SN  
**Trim Options:** CG

**Socket:**  
6 - Candelabra  
**Wattage:** 6 - 60 C

**Designer:**  
E. F. Chapman

©EFC DESIGNS

CHC1547AB



**CHC1523GI-CG**  
**Alexandra Chandelier**  
in Gilded Iron  
with Crystal  
Height: 36.5"  
Width: 32.75"  
Canopy: 5.5" Round

**Finishes:** GI  
**Trim Options:** CG

**Socket:**  
6 - Candelabra  
**Wattage:** 6 - 60 C

**Designer:**  
E. F. Chapman

©EFC DESIGNS





**TOB5036BSL**  
**Elizabeth Chandelier**  
**in Burnished Silver**  
**Leaf with Quartz**  
Height: 32.5"  
Width: 30.5"  
Canopy: 6" Round

**Finishes:** BSL, GI  
**Trim Options:** Q

**Socket:**  
6 - Candelabra  
**Wattage:** 6 - 60 C

**Designer:**  
Thomas O'Brien



**TOB5036GI**



**TOB5470BSL**  
**Yves Chandelier in**  
**Burnished Silver Leaf**  
**with Crystal**  
 Fixture Height: 35.75"  
 Width: 31"  
 Canopy: 6" Decorative

**Finishes:** BSL, GI  
**Glass Options:** CG

**Socket:**  
 9 - Candelabra  
**Wattage:** 9 - 60 C

**Designer:**  
 Thomas O'Brien



**TOB5470GI**



**ARN5110PN-CG**  
**Montmartre Chandelier**  
**in Polished Nickel**  
**with Crystal**  
 Fixture Height: 39.25"  
 Width: 39.75"  
 Canopy: 7" Round

**Finishes:** HAB, PN  
**Trim Options:** CG

**Socket:**  
 8 - Candelabra  
**Wattage:** 8 - 60 C

**Designer:**  
 AERIN



**ARN5110HAB-CG**



**ARN5108HAB-CG**  
**Vestry Chandelier in**  
**Hand-Rubbed Antique**  
**Brass with Crystal**  
Height: 48"  
Width: 41"  
Canopy: 7.5" Round

**Finishes:** HAB  
**Trim Options:** CG

**Socket:**  
12 - Candelabra  
**Wattage:** 12 - 60 C

**Designer:**  
AERIN



**CHC1550BSL-CG**  
**Oslo Medium**  
**Chandelier in**  
**Burnished Silver**  
**Leaf with Crystal**  
Height: 33.75"  
Width: 32.75"  
Canopy: 5.5" Round

**Finishes:** BSL, GI  
**Trim Options:** CG

**Socket:**  
6 - Candelabra  
**Wattage:** 6 - 60 C

**Designer:**  
E. F. Chapman

©EFC DESIGNS





**CHC1550BSL-CG**  
**Oslo Medium Chandelier**  
**in Burnished Silver**  
**Leaf with Crystal**  
Height: 33.75"  
Width: 32.75"  
Canopy: 5.5" Round

**Finishes:** BSL, GI  
**Trim Options:** CG

**Socket:**  
6 - Candelabra  
**Wattage:** 6 - 60 C

**Designer:**  
E. F. Chapman

©EFC DESIGNS



CHC1550GI-CG



**CHC1551BSL-CG**  
**Oslo Large Chandelier**  
**in Burnished Silver**  
**Leaf with Crystal**  
Height: 44.75"  
Width: 43.25"  
Canopy: 6.25" Round

**Finishes:** BSL, GI  
**Trim Options:** CG

**Socket:**  
8 - Candelabra  
**Wattage:** 8 - 60 C

**Designer:**  
E. F. Chapman

©EFC DESIGNS



CHC1551GI-CG



**CHC1559BSL-CG**  
**Oslo Mini Chandelier**  
 in Burnished Silver  
 Leaf and Crystal  
 Fixture Height: 15"  
 Width: 17"  
 Canopy: 5.5" Round

**Finishes:** BSL, GI  
**Trim Options:** CG

**Socket:**  
 5 - Candelabra  
**Wattage:** 5 - 60 C

**Designer:**  
 E. F. Chapman

©EFC DESIGNS



CHC1559GI-CG



**CHC1552BSL-CG**  
**Oslo Small Chandelier**  
 in Burnished Silver  
 Leaf with Crystal  
 Height: 26.25"  
 Width: 23.25"  
 Canopy: 5.5" Round

**Finishes:** BSL, GI  
**Trim Options:** CG

**Socket:**  
 6 - Candelabra  
**Wattage:** 6 - 60 C

**Designer:**  
 E. F. Chapman

©EFC DESIGNS



CHC1552GI-CG



**NW5030VS**  
**Milan Medium Chandelier**  
**in Venetian Silver**  
**with Crystal**  
Fixture Height: 36"  
Width: 29.25"  
Canopy: 6" Round

**Finishes:** VG, VS  
**Trim Options:** CG

**Socket:**  
6 - Candelabra  
**Wattage:** 6 - 60 C

**Designer:**  
Niermann Weeks

NW5030VG



**NW5031VS**  
**Milan Large Chandelier**  
**in Venetian Silver**  
**with Crystal**  
Fixture Height: 44"  
Width: 38"  
Canopy: 6" Round

**Finishes:** VG, VS  
**Trim Options:** CG

**Socket:**  
6 - Candelabra  
**Wattage:** 6 - 60 C

**Designer:**  
Niermann Weeks

NW5031VG

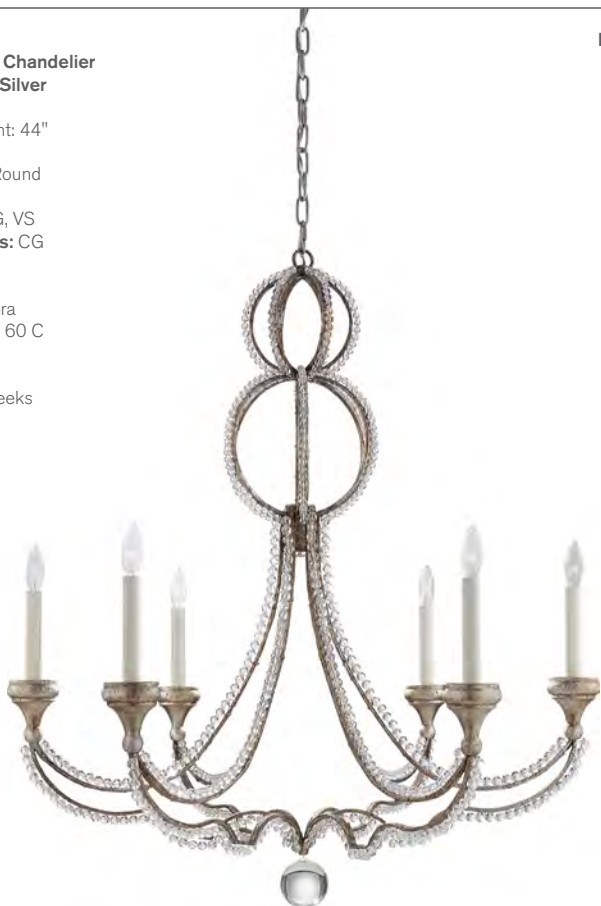

**SK5100PN**  
**Hurley Chandelier**  
 in Polished Nickel  
 with Crystal  
 Height: 26"  
 Width: 15.5"  
 Canopy: 5" Round

**Finishes:** HAB, PN  
**Trim Options:** CG

**Socket:**  
 3 - Candelabra  
**Wattage:** 3 - 40 C

**Designer:**  
 Suzanne Kasler



SK5100HAB



**CHC1501BSL**  
**Middleton 6-Light**  
**Chandelier in**  
**Burnished Silver Leaf**  
 with Crystal  
 Height: 44"  
 Width: 32.75"  
 Canopy: 5.5" Round

**Finishes:** BSL, GI  
**Trim Options:** CG

**Socket:**  
 6 - Candelabra  
**Wattage:** 6 - 60 C

**Designer:**  
 E. F. Chapman

©EFC DESIGNS

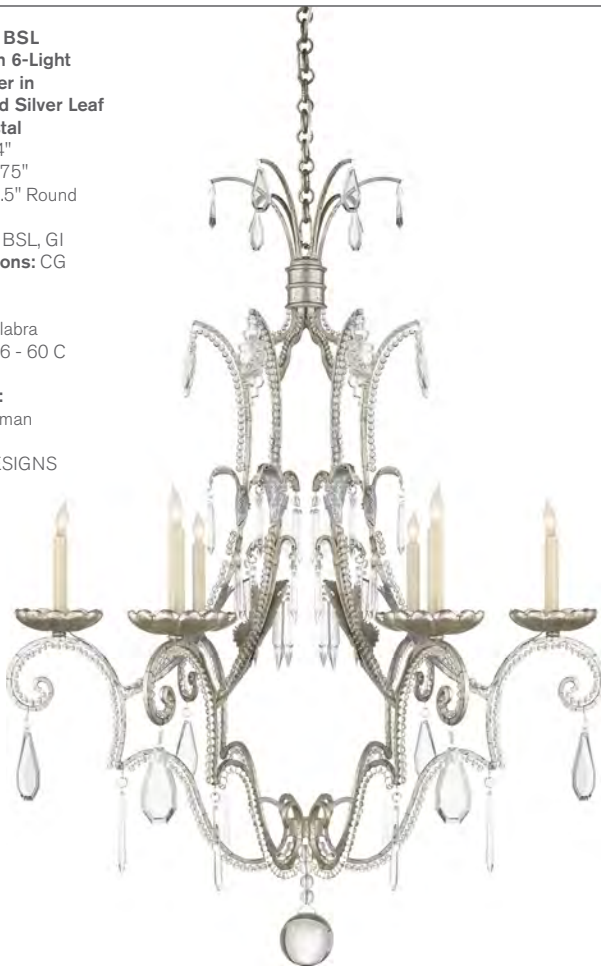

CHC1501GI



**CHC2138PN-CG**  
**Devon Mini Glass**  
**Bowl Pendant in**  
**Polished Nickel**  
**with Clear Glass**  
Height: 17"  
Width: 11"  
Canopy: 5" Round

**Finishes:** GI, PN  
**Glass Options:** CG

**Socket:**  
4 - Candelabra  
**Wattage:** 4 - 60 C

**Designer:**  
E. F. Chapman

©EFC DESIGNS



**CHC2138GI-CG**



**CHC1555PN-CG**  
**Penhurst Medium**  
**Chandelier in**  
**Polished Nickel**  
**with Clear Glass**  
Height: 37.75"  
Width: 25.75"  
Canopy: 5.5" Round

**Finishes:** GI, PN  
**Trim Options:** CG

**Socket:**  
6 - Candelabra  
**Wattage:** 6 - 60 C

**Designer:**  
E. F. Chapman

©EFC DESIGNS



**CHC1555GI-CG**



**CHC1521GI-SG**  
**Jumbo Orvieto**  
**Chandelier in**  
**Gilded Iron with**  
**Seeded Glass**  
Height: 58.5"  
Width: 43.75"  
Canopy: 5" Round

**Finishes:** AI, GI  
**Trim Options:** SG

**Socket:**  
12 - Candelabra  
**Wattage:** 12 - 60 C

**Designer:**  
E. F. Chapman

©EFC DESIGNS

CHC1521AI-SG



**CHC1420GI-SG**  
**Piedmont Chandelier**  
in Gilded Iron with  
Seeded Glass  
Height: 33"  
Width: 32"  
Canopy: 5.5" Round

**Finishes:**  
AB, AI, AN,  
BZ, GI, R  
**Trim Options:** SG

**Socket:**  
6 - Candelabra  
**Wattage:** 6 - 60 C

**Note:** Use 40 Watt  
Frosted Type "B"  
with Clip On Shade

**Designer:**  
E. F. Chapman

©EFC DESIGNS



CHC1420AI-SG



**CHC1520GI-SG**  
**Orvieto Large**  
Chandelier in  
Gilded Iron with  
Seeded Glass  
Height: 43.75"  
Width: 33.5"  
Canopy: 5.5" Round

**Finishes:** AI, GI  
**Trim Options:** SG

**Socket:**  
12 - Candelabra  
**Wattage:** 12 - 60 C

**Designer:**  
E. F. Chapman

©EFC DESIGNS



CHC1520AI-SG







**NW5005RS-CG**  
**Lombardy Single**  
**Tier Chandelier**  
**in Rusted Steel**  
Fixture Height: 23"  
Width: 21.25"  
Canopy: 5" Round

**Finishes:** RS  
**Trim Options:** CG

**Socket:**  
5 - Candelabra  
**Wattage:** 5 - 60 C

**Designer:**  
Niermann Weeks



**NW5006RS-CG**  
**Lombardy Double**  
**Tier Chandelier**  
**in Rusted Steel**  
Fixture Height: 36"  
Width: 36"  
Canopy: 5" Round

**Finishes:** RS  
**Trim Options:** CG

**Socket:**  
12 - Candelabra  
**Wattage:** 12 - 60 C

**Designer:**  
Niermann Weeks



**NW5015AGP**  
**Lyon Large Flared Top Chandelier in Antique Gild and Polychrome with Crystal**  
Fixture Height: 43"  
Width: 27.75"  
Canopy: 6" Round

**Finishes:** AGP  
**Trim Options:** CG

**Socket:**  
6 - Candelabra  
**Wattage:** 6 - 60 C

**Designer:**  
Niermann Weeks



**NW5016AGP-CG**  
**Lyon Large Chandelier in Antique Gild and Polychrome with Crystal**  
Fixture Height: 57"  
Width: 39.75"  
Canopy: 6" Round

**Finishes:** AGP  
**Trim Options:** CG

**Socket:**  
12 - Candelabra  
**Wattage:** 12 - 60 C

**Designer:**  
Niermann Weeks







**CHC1408AB-SG**  
**Paris Flea Market**  
**Large Chandelier in**  
**Antique-Burnished**  
**Brass with**  
**Seeded Glass**  
Height: 33"  
Width: 32"  
Canopy: 5.25" Round

**Finishes:**  
AB, GI, PS, SHS  
**Trim Options:** SG

**Socket:** 8 - Candelabra  
**Wattage:** 8 - 60 C

**Note:** Item Includes  
Glass Trim Which is  
Intended to Only Fill  
Half of the Space.  
Additional Trim is  
Available for Purchase.

**Designer:**  
E.F. Chapman

©EFC DESIGNS

CHC1408GI-SG



**CHC1508AB-SG**  
**Paris Flea Market**  
**Grande Chandelier**  
**in Antique-Burnished**  
**Brass with**  
**Seeded Glass**  
Height: 41"  
Width: 39.5"  
Canopy: 5.25" Round

**Finishes:** AB, SHS  
**Trim Options:** SG

**Socket:**  
12 - Candelabra  
**Wattage:** 12 - 60 C

**Note:** Item Includes  
Glass Trim Which is  
Intended to Only Fill  
Half of the Space.  
Additional Trim is  
Available for Purchase.

**Designer:**  
E.F. Chapman

©EFC DESIGNS



**CHC1407PS-SG**  
**Petite Paris Flea**  
**Market Chandelier in**  
**Polished Silver and**  
**Seeded Glass**  
 Height: 17.5"  
 Width: 16.25"  
 Canopy: 5.25" Round

**Finishes:**  
 AB, GI, PS, SHS  
**Trim Options:** SG

**Socket:**  
 6 - Candelabra  
**Wattage:** 6 - 60 C

**Note:** Item Includes  
 Glass Trim Which is  
 Intended to Only  
 Fill Half of the Space.  
 Additional Trim is  
 Available for Purchase.

**Designer:**  
 E.F. Chapman

©EFC DESIGNS



CHC1407AB-SG



**CHC1426SHS-SG**  
**Paris Flea Market**  
**Medium Chandelier in**  
**Sheffield Silver and**  
**Seeded Glass**  
 Height: 26"  
 Width: 24"  
 Canopy: 5.25" Round

**Finishes:**  
 AB, GI, PS, SHS  
**Trim Options:** SG

**Socket:**  
 8 - Candelabra  
**Wattage:** 8 - 60 C

**Note:** Item Includes  
 Glass Trim Which is  
 Intended to Only Fill  
 Half of the Space.  
 Additional Trim is  
 Available for Purchase.

**Designer:**  
 E.F. Chapman

©EFC DESIGNS



CHC1426AB-SG



**SR5144AGW**  
**Princess Mari Ann**  
**Crystal Chandelier**  
**in Antique Gilded**  
**Wood with Crystal**  
Height: 54.5"  
Width: 36.5"  
Canopy: 5.5" Round

**Finishes:** AGW  
**Trim Options:** CG

**Socket:**  
8 - Candelabra  
**Wattage:** 8 - 60 C

**Designer:**  
John Rosselli



**CHC1554OW-NP**  
**Montmartre Chandelier**  
**in Old White**  
**and Glass with**  
**Natural Paper Shades**  
Height: 44"  
Width: 33.75"  
Canopy: 5.75" Round

**Finishes:** OW  
**Shade Treatments:** NP  
**Shade Details:**  
4" x 5.5" x 5"

**Socket:**  
8 - Candelabra  
**Wattage:** 8 - 40 B

**Designer:**  
E. F. Chapman

©EFC DESIGNS





**CHC1543BW-SG**  
**Flanders Small**  
**Chandelier in Belgian**  
**White with Seeded**  
**Glass Beads**  
 Height: 24"  
 Width: 26"  
 Canopy: 5.5" Round

**Finishes:** BW  
**Trim Options:** SG

**Socket:**  
 8 - Candelabra  
**Wattage:** 8 - 60 C

**Designer:**  
 E. F. Chapman

©EFC DESIGNS



**CHC1548BW-SG**  
**Flanders Chandelier**  
**in Belgian White with**  
**Seeded Glass Beads**  
 Height: 34"  
 Width: 36.25"  
 Canopy: 5.5" Round

**Finishes:** BW  
**Trim Options:** SG

**Socket:**  
 8 - Candelabra  
**Wattage:** 8 - 60 C

**Designer:**  
 E. F. Chapman

©EFC DESIGNS



**CHC5380OW-CG**  
**Multi Arm Branch**  
**Chandelier in Old**  
**White with Glass**  
 Fixture Height: 36.5"  
 Width: 36.75"  
 Canopy: 5.5" Round

**Finishes:** GI  
**Glass Options:** CG

**Socket:**  
 6 - Candelabra  
**Wattage:** 6 - 60 C

**Designer:**  
 E. F. Chapman

©EFC DESIGNS

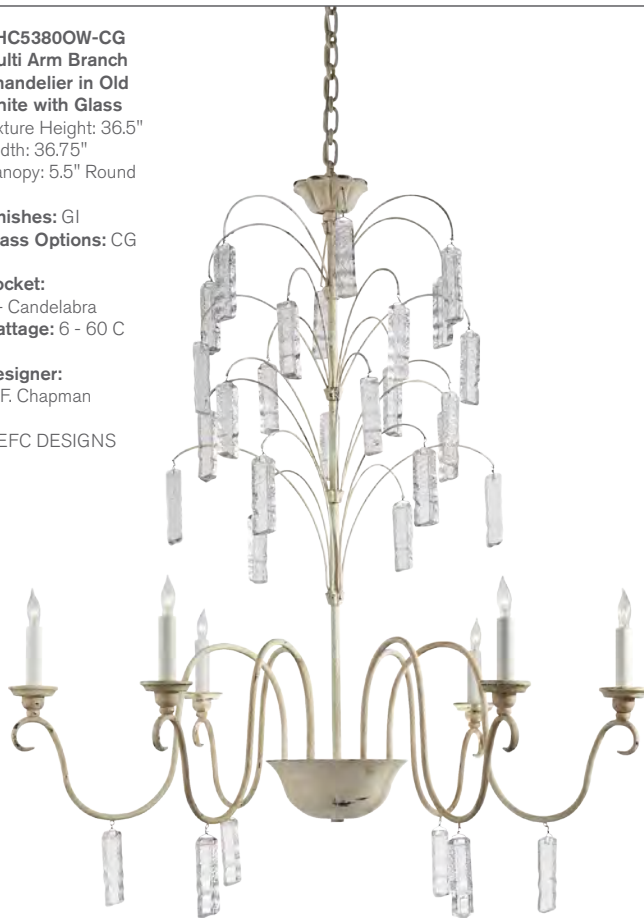

**CHC5380GI-CG**



**SC5015PN**  
**Twist Chandelier in Polished Nickel**  
 Height: 30"  
 Width: 26"  
 Canopy: 5.75" Round

**Finishes:**  
 AS, BZ, HAB, PN

**Socket:**  
 5 - Candelabra  
**Wattage:** 5 - 60 C

**Designer:**  
 Eric Cohler



SC5015HAB



**SC5005PN**  
**Double Twist Large Chandelier in Polished Nickel**  
 Height: 29.75"  
 Width: 36"  
 Canopy: 5.75" Round

**Finishes:**  
 AS, BZ, HAB, PN

**Socket:**  
 5 - Candelabra  
**Wattage:** 5 - 60 C

**Designer:**  
 Eric Cohler



SC5005HAB



SC5005HAB





**CHC1561AB**  
**Mykonos Small**  
**Chandelier in**  
**Antique-Burnished Brass**

Height: 29"  
Width: 27.5"  
Canopy: 6.5" Octagon

**Finishes:** AB, AI

**Socket:** 8 - Candelabra  
**Wattage:** 8 - 60 C

**Note:** CHS104NP Sold Separately/Use 40 Watt Frosted Type "B" with Clip On Shade

**Designer:**  
E. F. Chapman

©EFC DESIGNS

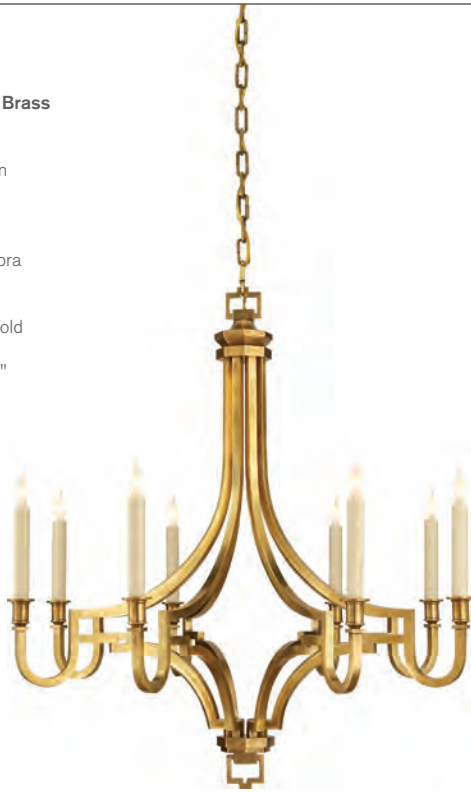

CHC1561AI



**CHC1562AB**  
**Mykonos Large**  
**Chandelier in**  
**Antique-Burnished Brass**

Height: 38.75"  
Width: 37"  
Canopy: 6.5" Octagon

**Finishes:** AB, AI

**Socket:** 8 - Candelabra  
**Wattage:** 8 - 60 C

**Note:** CHS104NP Sold Separately/Use 40 Watt Frosted Type "B" with Clip On Shade

**Designer:**  
E. F. Chapman

©EFC DESIGNS



CHC1562AI



**CHC2461AN-NP**  
**Ruhlmann Small**  
**Chandelier in Antique**  
**Nickel with Natural**  
**Paper Shades**  
 Height: 17.5"  
 Width: 17.5"  
 Canopy: 5.5" Round

**Finishes:**  
 AB, AN, BZ, PN  
**Shade Treatments:** NP  
**Shade Details:**  
 3" x 4" x 4"

**Socket:**  
 3 - Candelabra  
**Wattage:** 3 - 40 B

**Designer:**  
 E. F. Chapman

©EFC DESIGNS



CHC2461PN-NP



CHC2461AB-NP



**CHC2463PN-NP**  
**Ruhlmann Pendant in**  
**Polished Nickel with**  
**Natural Paper Shade**  
 Height: 29"  
 Width: 22"  
 Canopy: 5.5" Round

**Finishes:**  
 AB, AN, BZ, PN  
**Shade Treatments:** NP  
**Shade Details:**  
 19" x 22" x 12"

**Socket:**  
 3 - Candelabra  
**Wattage:** 3 - 60 B

**Designer:**  
 E. F. Chapman

©EFC DESIGNS



CHC2463AB-NP



**CHC2462PN-NP**  
**Ruhlmann Large**  
**Chandelier in Polished**  
**Nickel with Natural**  
**Paper Shades**  
Height: 24.25"  
Width: 35.25"  
Canopy: 5.5" Round

**Finishes:**  
AB, AN, BZ, PN  
**Shade Treatments:** NP  
**Shade Details:**  
4" x 5" x 6.5"

**Socket:** 6 - Keyless  
**Wattage:** 6 - 60 B

**Designer:**  
E.F. Chapman

©EFC DESIGNS







**CHC2465PN-NP**  
Ruhlmann 2-Tier  
Chandelier in Polished  
Nickel with Natural  
Paper Shades  
Height: 31.75"  
Width: 35"  
Canopy: 5.5" Round

**Finishes:**  
AB, AN, BZ, PN  
**Shade Treatments:** NP  
**Shade Details:**  
4" x 5" x 6.5"

**Socket:**  
9 - Candelabra  
**Wattage:** 9 - 60 B

**Designer:**  
E. F. Chapman

©EFC DESIGNS



**CHC2465AN-NP**



**CHC2465AB-NP**



**CHC2465BZ-NP**



**ARN5112PN-L**  
**Tuileries Chandelier**  
in Polished Nickel  
with Linen Shades  
Fixture Height: 21.5"  
Width: 36"  
Canopy: 5.5" Round

**Finishes:** HAB, PN  
**Shade Treatments:** L  
**Shade Details:**  
5" x 6.5" x 6.5"

**Socket:**  
8 - Candelabra  
**Wattage:** 8 - 60 B

**Designer:**  
AERIN



**ARN5112HAB-L**







**NW5040AM/HAB**  
**Lido Medium Chandelier**  
in Antique Mirror  
and Hand-Rubbed  
Antique Brass  
Height: 33"  
Width: 25.5"  
Canopy: 5.5" Round

**Finishes:** AM/HAB

**Socket:**  
4 - Candelabra  
**Wattage:** 4 - 60 C

**Designer:**  
Niermann Weeks



**NW5041AM/HAB**  
**Lido Large Chandelier**  
in Antique Mirror  
and Hand-Rubbed  
Antique Brass  
Height: 35"  
Width: 38.25"  
Canopy: 5.5" Round

**Finishes:** AM/HAB

**Socket:**  
6 - Candelabra  
**Wattage:** 6 - 60 C

**Designer:**  
Niermann Weeks



**AH5010PN-NP**  
**Myrna Chandelier in**  
**Polished Nickel with**  
**Natural Paper Shades**  
 Height: 21"  
 Width: 33"  
 Canopy: 4.5" Round

**Finishes:**  
 GM, NB, PN  
**Shade Treatments:** NP  
**Shade Details:**  
 3" x 6.5" x 5"

**Socket:**  
 6 - Candelabra  
**Wattage:** 6 - 40 B

**Designer:**  
 Alexa Hampton



**AH5010NB-NP**



**MS5020PN-NP**  
**Eiffel Chandelier in Polished Nickel with Natural Paper Shades**  
Height: 12.5"  
Width: 22"  
Canopy: 6" Square

**Finishes:**  
BZ, HAB, PN, SN  
**Shade Treatments:** NP  
**Shade Details:**  
5" x 7" x 5.5"

**Socket:**  
4 - Candelabra  
**Wattage:** 4 - 60 B

**Designer:**  
Michael S Smith



**MS5020HAB-NP**



**MS5025PN-NP**  
**Palma Chandelier in Polished Nickel with Natural Paper Shades**  
Height: 15"  
Width: 27.5"  
Canopy: 6" Round

**Finishes:**  
BZ, HAB, PN, SN  
**Shade Treatments:** NP  
**Shade Details:**  
5" x 8" x 6"

**Socket:**  
4 - Candelabra  
**Wattage:** 4 - 60 B

**Designer:**  
Michael S Smith



**MS5025HAB-NP**



**SC5102PN**  
**Armillary Sphere**  
**Chandelier in**  
**Polished Nickel**  
Height: 24.75"  
Width: 34.75"  
Canopy: 5.5" Round

**Finishes:**  
BZ, HAB, PN

**Socket:**  
6 - Candelabra  
**Wattage:** 6 - 60 C

**Designer:**  
Eric Cohler



SC5102HAB



SC5102BZ





**SC5001HAB**  
Venetian Medium  
Chandelier in  
Hand-Rubbed  
Antique Brass  
Height: 23"  
Width: 24.5"  
Canopy: 14.5" Star

**Finishes:**  
AS, BZ, HAB, PN

**Socket:**  
6 - Candelabra  
**Wattage:** 6 - 60 C



SC5001AS



**SC5002BZ**  
Venetian Medium  
Two-Tier in Bronze  
Height: 23"  
Width: 28"  
Canopy: 14.5" Star

**Finishes:**  
AS, BZ, HAB, PN

**Socket:**  
9 - Candelabra  
**Wattage:** 9 - 60 C

**Designer:**  
Eric Cohler



SC5002PN



**TOB5017BZ/HAB-NP**  
**Farlane Large Chandelier**  
in Bronze with  
Hand-Rubbed Antique  
Brass and Natural  
Paper Shades  
O/A Height: 60"  
Min. Custom Height: 34"  
Width: 48"  
Canopy: 5.75" Round

**Finishes:**  
AN, BZ/HAB, HAB, PS  
**Shade Treatments:**  
NP, NP/RT  
**Shade Details:**  
3" x 5" x 7"

**Socket:**  
12 - Candelabra  
**Wattage:** 12 - 40 B

**Note:** Custom Height  
Available/Slope  
Mount Included



**TOB5018PS-NP**  
**Farlane Small Chandelier**  
**in Polished Silver with**  
**Natural Paper Shades**  
O/A Height: 60"  
Min. Custom Height: 30"  
Width: 34"  
Canopy: 5.75" Round

**Finishes:**  
AN, BZ/HAB, HAB, PS  
**Shade Treatments:**  
NP, NP/RT  
**Shade Details:**  
3" x 5" x 7"

**Socket:**  
6 - Candelabra  
**Wattage:**  
6 - 40 B

**Note:**  
Custom Height  
Available/Slope  
Mount Included

**TOB5018AN-NP**



**TOB5018HAB-NP**



**TOB5018BZ/HAB-NP**



**TOB5019PN-NP**  
**Reed Extra Large**  
**Chandelier in Polished**  
**Nickel with Natural**  
**Paper Shades**  
Height: 35"  
Width: 33"  
Canopy: 5.25" Round

**Finishes:**  
AN, BZ, HAB, PN  
**Shade Treatments:** NP  
**Shade Details:**  
4" x 5" x 5.75"

**Socket:**  
16 - Candelabra  
**Wattage:** 16 - 40 B

**Designer:**  
Thomas O'Brien



**TOB5009PN-NP**  
**Reed Small Chandelier**  
in Polished Nickel with  
Natural Paper Shades  
O/A Height: 30"  
Min. Custom Height: 20"  
Width: 20"  
Canopy: 5.25" Round

**Finishes:**  
AN, BZ, HAB, PN  
**Shade Treatments:** NP  
**Shade Details:**  
4" x 5" x 5.75"

**Socket:**  
3 - Candelabra  
**Wattage:** 3 - 60 B

**Note:**  
Custom Height  
Available/Height  
Cannot Be Modified  
In The Field

**Designer:**  
Thomas O'Brien



TOB5009HAB-NP



**TOB5010PN-NP**  
**Reed Large Chandelier**  
in Polished Nickel with  
Natural Paper Shades  
O/A Height: 37.5"  
Min. Custom Height: 30"  
Width: 26.5"  
Canopy: 5.25" Round

**Finishes:**  
AN, BZ, HAB, PN  
**Shade Treatments:** NP  
**Shade Details:**  
4" x 5" x 5.75"

**Socket:**  
8 - Candelabra  
**Wattage:** 8 - 60 B

**Note:**  
Custom Height  
Available/Height  
Cannot Be Modified  
In The Field

**Designer:**  
Thomas O'Brien



TOB5010HAB-NP





**TOB5007PN-NP**  
**Vendome Small**  
**Chandelier in Polished**  
**Nickel with Natural**  
**Paper Shades**  
O/A Height: 44"  
Min. Custom Height: 26"  
Width: 26"  
Canopy: 5.25" Round

**Finishes:**  
AS, BZ, HAB, PN  
**Shade Treatments:**  
NP, NP/BT  
**Shade Details:**  
4" x 5.5" x 6"  
Candle Clip

**Socket:**  
4 - Candelabra  
**Wattage:** 4 - 60 B

**Note:**  
Custom Height  
Available/Slope  
Mount Included



**TOB5007HAB-NP**



**TOB5008AS-NP**  
**Vendome Large**  
**Chandelier in Antique**  
**Silver with Natural**  
**Paper Shades**  
O/A Height: 44"  
Min. Custom Height: 27"  
Width: 36"  
Canopy: 5.25" Round

**Finishes:**  
AS, BZ, HAB  
**Shade Treatments:** NP  
**Shade Details:**  
4" x 5.5" x 6"

**Socket:**  
8 - Candelabra  
**Wattage:** 8 - 60 B

**Note:**  
Custom Height  
Available/Slope  
Mount Included

**Designer:**  
Thomas O'Brien



**TOB5002PN-NP**  
**Bryant Small**  
**Chandelier in Polished**  
**Nickel with Natural**  
**Paper Shades**  
 O/A Height: 48"  
 Min. Custom Height: 28"  
 Width: 26"  
 Canopy: 7" Round

**Finishes:**  
 AN, BZ, HAB, PN  
**Shade Treatments:** NP  
**Shade Details:**  
 4" x 5.5" x 6"

**Socket:** 4 - Keyless  
**Wattage:** 4 - 60 A

**Note:**  
 Custom Height  
 Available/Slope  
 Mount Included

**Designer:**  
 Thomas O'Brien



**TOB5002HAB-NP**



**TOB5003BZ-NP**  
**Bryant Large Chandelier**  
**in Bronze with**  
**Natural Paper Shades**  
 O/A Height: 48"  
 Min. Custom Height: 28"  
 Width: 36"  
 Canopy: 7" Round

**Finishes:**  
 AN, BZ, HAB, PN  
**Shade Treatments:** NP  
**Shade Details:**  
 4" x 5.5" x 6"

**Socket:** 4 - Keyless  
**Wattage:** 4 - 60 A

**Note:**  
 Custom Height  
 Available/Slope  
 Mount Included

**Designer:**  
 Thomas O'Brien







**TOB5045HAB-NP**  
**Caron Small Chandelier**  
 in Hand-Rubbed  
 Antique Brass with  
 Natural Paper Shades  
 O/A Height: 36"  
 Fixture Height: 15.75"  
 Min. Custom Height: 21"  
 Width: 18"  
 Canopy: 4.75" Round

**Finishes:**  
 BZ/HAB, HAB, PN  
**Shade Treatments:** NP  
**Shade Details:**  
 4" x 5" x 6.5"

**Socket:**  
 4 - Candelabra  
**Wattage:** 4 - 60 C

**Note:** Custom  
 Height Available

**Designer:**  
 Thomas O'Brien



TOB5045BZ/HAB-NP



**TOB5046HAB-NP**  
**Caron Large Chandelier**  
 in Hand-Rubbed  
 Antique Brass with  
 Natural Paper Shades  
 O/A Height: 40"  
 Fixture Height: 16"  
 Min. Custom Height: 21"  
 Width: 30"  
 Canopy: 4.75" Round

**Finishes:**  
 BZ/HAB, HAB, PN  
**Shade Treatments:** NP  
**Shade Details:**  
 4" x 5" x 6.5"

**Socket:**  
 8 - Candelabra  
**Wattage:** 8 - 60 C

**Note:** Custom  
 Height Available

**Designer:**  
 Thomas O'Brien



TOB5046BZ/HAB-NP



**TOB5015PN-NP**  
**Ziyi Small Chandelier**  
in Polished Nickel  
with Natural  
Paper Shades  
O/A Height: 44.5"  
Min. Custom Height: 32"  
Width: 24"  
Canopy: 4.25" Round

**Finishes:**  
BZ, HAB, PN  
**Shade Treatments:** NP  
**Shade Details:**  
4" x 4" x 9.5"

**Socket:**  
4 - Candelabra  
**Wattage:** 4 - 25 B

**Note:** Custom  
Height Available

**Designer:**  
Thomas O'Brien



**TOB5015BZ-NP**



**TOB5016HAB-NP**  
**Ziyi Large Chandelier**  
in Hand-Rubbed  
Antique Brass with  
Natural Paper Shades  
O/A Height: 44.5"  
Min. Custom Height: 32"  
Width: 33.5"  
Canopy: 4.25" Round

**Finishes:**  
BZ, HAB, PN  
**Shade Treatments:** NP  
**Shade Details:**  
4" x 4" x 9.5"

**Socket:**  
8 - Candelabra  
**Wattage:** 8 - 25 B

**Note:** Custom  
Height Available

**Designer:**  
Thomas O'Brien



**TOB5016BZ-NP**



**BBL5080G-S**  
**Go Lightly Small**  
**Chandelier in Gilded**  
**with Silk Shades**  
 Height: 14"  
 Width: 19.75"  
 Canopy: 4.5" Round

**Finishes:**  
 C, CW, G  
**Shade Treatments: S**  
**Shade Details:**  
 5.5" x 6" x 7"

**Socket:**  
 4 - Candelabra  
**Wattage:** 4 - 40 B

**Designer:**  
 Barbara Barry



BBL5080C-S



**BBL5081CW-S**  
**Go Lightly Medium**  
**Chandelier in**  
**China White with**  
**Silk Shades**  
 Height: 24.75"  
 Width: 31"  
 Canopy: 4.5" Round

**Finishes:**  
 C, CW, G  
**Shade Treatments: S**  
**Shade Details:**  
 5.5" x 6" x 7"

**Socket:**  
 8 - Candelabra  
**Wattage:** 8 - 40 B

**Designer:**  
 Barbara Barry

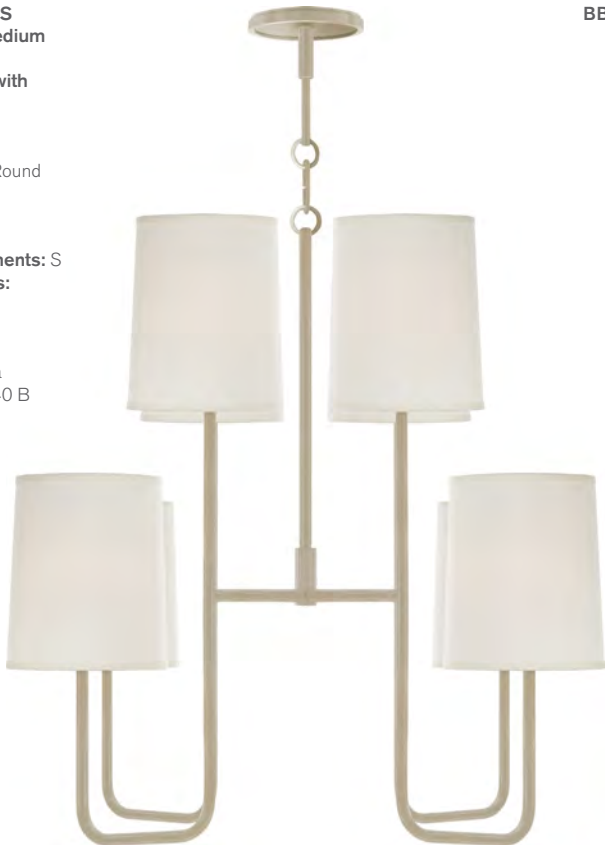

BBL5081C-S



**ARN5052BSL-L**  
**Montreuil Chandelier in**  
**Burnished Silver Leaf**  
**with Linen Shades**

Fixture Height: 33.25"  
Width: 34.5"  
Canopy: 7" Round

**Finishes:** BSL, G  
**Shade Treatments:** L  
**Shade Details:**  
2.5" x 5" x 8"

**Socket:**  
10 - Candelabra  
**Wattage:** 10 - 60 B

**Designer:**  
AERIN



**ARN5052G-L**



**S5040PN**  
**Choros Chandelier**  
**in Polished Nickel**  
 Height: 25.5"  
 Width: 28.75"  
 Canopy: 5.5" Round

**Finishes:** AI, PN

**Socket:**  
 6 - Candelabra  
**Wattage:** 6 - 60 C

**Designer:**  
 Barry Goralnick



S5040AI



**S5041PN**  
**Choros Two-Tier**  
**Chandelier in**  
**Polished Nickel**  
 Height: 43"  
 Width: 37.25"  
 Canopy: 5.5" Round

**Finishes:** AI, PN

**Socket:**  
 12 - Candelabra  
**Wattage:** 12 - 60 C

**Designer:**  
 Barry Goralnick



S5041AI



**S5022HAB-WG**  
**Bistro Medium**  
**Chandelier in**  
**Hand-Rubbed**  
**Antique Brass with**  
**White Glass**  
O/A Height: 60"  
Fixture Height: 29"  
Minimum Height: 32"  
Width: 47"  
Canopy: 4.5" Round

**Finishes:** HAB, PN  
**Glass Options:**  
CG, WG

**Socket:**  
12 - Candelabra  
**Wattage:** 12 - 40 B

**Note:** Custom  
Height Available

**Designer:**  
Ian Fowler



**S5024PN/BLK-CG**  
**Bistro Four Arm**  
**Chandelier in Polished**  
**Nickel and Black**  
**with Clear Glass**  
 O/A Height: 68"  
 Fixture Height: 27"  
 Width: 52"  
 Canopy: 4.5" Round

**Finishes:** HAB/BLK,  
 PN, PN/BLK  
**Glass Options:**  
 CG, WG

**Socket:** 13 - Keyless  
**Wattage:** 13 - 40 G

**Note:** Custom  
 Height Available

**Designer:**  
 Ian Fowler



**S5024HAB/BLK-WG**





**S5270PN-CG**  
**Bistro Small**  
**Round Chandelier**  
**in Polished Nickel**  
**with Clear Glass**  
Height: 22.5"  
Width: 22.5"  
Canopy: 4.5" Round

**Finishes:** HAB, PN  
**Glass Options:**  
CG, WG

**Socket:** 12 - Keyless  
**Wattage:** 12 - 40 G

**Designer:**  
Ian Fowler



**S5270HAB/BLK-WG**



**S5271PN-CG**  
**Bistro Medium**  
**Round Chandelier**  
**in Polished Nickel**  
**with Clear Glass**  
Height: 32"  
Width: 32"  
Canopy: 4.5" Round

**Finishes:** HAB, PN  
**Glass Options:** CG, WG

**Socket:** 18 - Keyless  
**Wattage:** 18 - 40 G

**Designer:**  
Ian Fowler



**S5271HAB/BLK-WG**



**ARN5009HAB-BLK**  
**Sommerard Triple Arm**  
**Chandelier in**  
**Hand-Rubbed Antique**  
**Brass and Black**  
O/A Height: 52"  
Fixture Height: 19"  
Min. Custom Height: 28"  
Width: 62.5"  
Canopy: 5.5" Round

**Finishes:** HAB  
**Shade Treatments:**  
BLK, WHT

**Socket:** 3 - Keyless  
**Wattage:** 3 - 60 A

**Note:** Custom  
Height Available

**Designer:**  
AERIN



**ARN5009HAB-WHT**



**S5395PN**  
**Horn Chandelier in**  
**Polished Nickel**  
O/A Height: 40"  
Fixture Height: 20"  
Min. Custom Height: 24"  
Width: 15"  
Canopy: 4.5" Round

**Finishes:**  
BZ, HAB, PN

**Socket:**  
6 - Candelabra  
**Wattage:** 6 - 40 C

**Note:**  
Custom Height  
Available/Slope  
Mount Included

**Designer:**  
Ian Fowler



**S5395HAB**



**S5395BZ**



**KW5200PN-CRG**  
**Liaison Single Tier**  
**Chandelier in**  
**Polished Nickel**  
**with Crackle Glass**  
 Fixture Height: 16.5"  
 Width: 20.5"  
 Canopy: 6" Round

**Finishes:** AB, BZ, PN  
**Glass Options:** CRG

**Socket:**  
 8 - Candelabra  
**Wattage:** 8 - 60 C

**Designer:**  
 Kelly Wearstler



**KW5201AB-CRG**  
**Liaison Double Tier**  
**Chandelier in**  
**Antique-Burnished**  
**Brass with**  
**Crackle Glass**  
 Fixture Height: 28.5"  
 Width: 34"  
 Canopy: 6" Round

**Finishes:** AB, BZ, PN  
**Glass Options:** CRG

**Socket:**  
 20 - Candelabra  
**Wattage:** 20 - 60 C

**Designer:**  
 Kelly Wearstler



**KW5202BZ-CRG**  
**Liaison Triple Tier**  
**Chandelier in Bronze**  
**with Crackle Glass**  
 Fixture Height: 39.5"  
 Width: 47.5"  
 Canopy: 6" Round

**Finishes:** AB, BZ, PN  
**Glass Options:** CRG

**Socket:**  
 32 - Candelabra  
**Wattage:** 32 - 60 C

**Designer:**  
 Kelly Wearstler





**SR5021HAB**  
**Natalya Large**  
**Chandelier in**  
**Hand-Rubbed**  
**Antique Brass**  
Height: 60"  
Width: 50.75"  
Canopy: 8.375" Round

**Finishes:** HAB, SN

**Socket:**  
8 - Candelabra  
**Wattage:** 8 - 60 C

**Designer:**  
John Rosselli



**SR5020HAB**  
Natalya Small  
Chandelier in  
Hand-Rubbed  
Antique Brass  
Height: 50"  
Width: 35"  
Canopy: 8.375" Round

**Finishes:** HAB, SN

**Socket:**  
8 - Candelabra  
**Wattage:** 8 - 60 C

**Designer:**  
John Rosselli

SR5020SN



**SR5017BZ-NP**  
**Millo Chandelier in**  
**Bronze with Natural**  
**Paper Shades**  
Height: 25"  
Width: 25"  
Canopy: 5" Square

**Finishes:**  
BZ, HAB, PN  
**Shade Treatments:** NP  
**Shade Details:**  
3.5" x 3.5" x 4.5" Square

**Socket:**  
6 - Candelabra  
**Wattage:** 6 - 40 B

**Designer:**  
John Rosselli



**SR5017HAB-NP**



**SR5017PN-NP**





**SR5141SHS**  
**Savannah Large**  
**Chandelier in**  
**Sheffield Silver**  
Height: 47"  
Width: 30.25"  
Canopy: 5" Round

**Finishes:** HAB, SHS

**Socket:**  
6 - Candelabra  
**Wattage:** 6 - 60 C

**Designer:**  
John Rosselli



**SR5140HAB**  
**Savannah Small**  
**Chandelier in**  
**Hand-Rubbed**  
**Antique Brass**  
Height: 24"  
Width: 16.25"  
Canopy: 5" Round

**Finishes:** HAB, SHS

**Socket:**  
4 - Candelabra  
**Wattage:** 4 - 60 C

**Designer:**  
John Rosselli



**SR5140SHS**





**CHC5370GI**  
**Gramercy Mini**  
**Chandelier in**  
**Gilded Iron**  
Height: 15.75"  
Width: 17"  
Canopy: 5.75" Round

**Finishes:** GI

**Socket:**  
4 - Candelabra  
**Wattage:** 4 - 60 C

**Designer:**  
E. F. Chapman

©EFC DESIGNS



**CHC5373GI**  
**Gramercy Medium**  
**Chandelier in**  
**Gilded Iron**  
Height: 33.75"  
Width: 32.5"  
Canopy: 5.75" Round

**Finishes:** GI

**Socket:**  
6 - Candelabra  
**Wattage:** 6 - 60 C

**Designer:**  
E. F. Chapman

©EFC DESIGNS



**CHC1474GI-NP**  
**Gramercy Large**  
**Chandelier in Gilded**  
**Iron with Natural**  
**Paper Shades**  
Height: 34"  
Width: 41.5"  
Canopy: 5.75" Round

**Finishes:** GI  
**Shade Treatments:** NP  
**Shade Details:**  
3" x 4" x 4"

**Socket:** 8 - Candelabra  
**Wattage:** 8 - 40 B

**Designer:**  
E. F. Chapman

©EFC DESIGNS



**SK5003BW**  
**Michele Chandelier**  
**in Belgian White**  
Height: 47.5"  
Width: 46.25"  
Canopy: 5" Round

**Finishes:** BW, FG

**Socket:**  
9 - Candelabra  
**Wattage:** 9 - 60 C

**Designer:**  
Suzanne Kasler

SK5003FG



**SK5004FG**  
**Michele Medium**  
**Chandelier in**  
**French Gild**  
Height: 38.25"  
Width: 43"  
Canopy: 5.25" Round

**Finishes:** BW, FG

**Socket:**  
6 - Candelabra  
**Wattage:** 6 - 60 C

**Designer:**  
Suzanne Kasler



**SK5095FGL**  
**Katherine Medium**  
**Chandelier in**  
**French Antique**  
**and Gold Leaf**  
Height: 34.25"  
Width: 25"  
Canopy: 5.5" Round

**Finishes:** FGL

**Socket:**  
6 - Candelabra  
**Wattage:** 6 - 60 C

**Designer:**  
Suzanne Kasler



**SK5001NR/OW**  
**Percival Large**  
**Chandelier in Natural**  
**Rusted Iron and**  
**Old White Wood**  
Height: 52"  
Width: 46.5"  
Canopy: 5.5" Round

**Finishes:** NR/OW

**Socket:**  
15 - Candelabra  
**Wattage:** 15 - 60 C

**Designer:**  
Suzanne Kasler



**SK5000NR/OW**  
**Percival Small**  
**Chandelier in Natural**  
**Rusted Iron and**  
**Old White Wood**  
Height: 32"  
Width: 31"  
Canopy: 5.5" Round

**Finishes:** NR/OW

**Socket:**  
6 - Candelabra  
**Wattage:** 6 - 60 C

**Designer:**  
Suzanne Kasler



**SK5002NR/OW**  
**Percival Medium**  
**Chandelier in Natural**  
**Rusted Iron and**  
**Old White Wood**  
Height: 43"  
Width: 38"  
Canopy: 5.5" Round

**Finishes:** NR/OW

**Socket:**  
13 - Candelabra  
**Wattage:** 13 - 60 C

**Designer:**  
Suzanne Kasler



**AH5025BW**  
**Dexter Small**  
**Chandelier in**  
**Belgian White**  
Height: 28"  
Width: 26"  
Canopy: 5.5" Round

AH5025WGL

**Finishes:** BW, WGL

**Socket:**  
8 - Candelabra  
**Wattage:** 8 - 60 C

**Designer:**  
Alexa Hampton

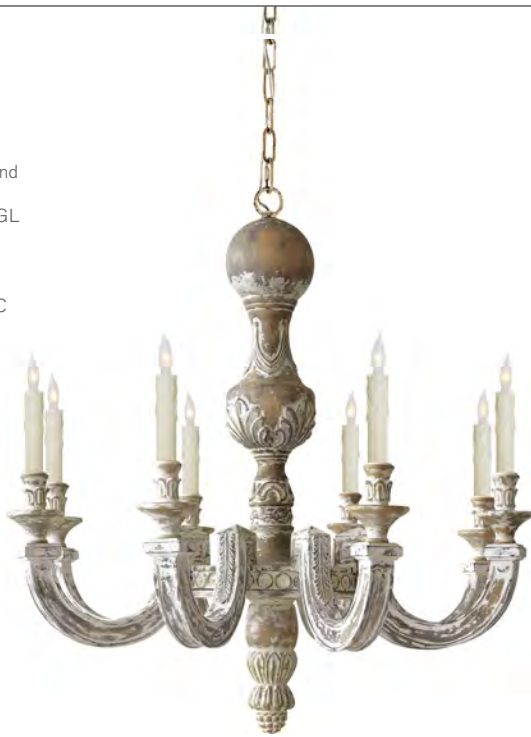

**AH5026BW**  
**Dexter Large**  
**Chandelier in**  
**Belgian White**  
Height: 35"  
Width: 36.5"  
Canopy: 5.5" Round

**Finishes:** BW, WGL

**Socket:**  
8 - Candelabra  
**Wattage:** 8 - 60 C

**Designer:**  
Alexa Hampton







**CHC1415AB-SG**  
**Marigot Medium**  
**Chandelier in**  
**Antique-Burnished**  
**Brass with Seeded**  
**Glass Trim**  
 Height: 30"  
 Width: 33"  
 Canopy: 5.5" Round

**Finishes:** AB, R  
**Trim Options:** SG

**Socket:**  
 6 - Candelabra  
**Wattage:** 6 - 60 C

**Designer:**  
 E. F. Chapman

©EFC DESIGNS



**CHC1415R**  
**Marigot Medium**  
**Chandelier in Rust**  
**and Old Brass**  
**with Tudor Brown**  
**Beaded Trim**



**CHC1413R**  
**Marigot Large**  
**Chandelier in Rust**  
**and Old Brass**  
**with Tudor Brown**  
**Beaded Trim**  
 Height: 36"  
 Width: 44"  
 Canopy: 5.5" Round

**Finishes:** R

**Socket:**  
 8 - Candelabra  
**Wattage:** 8 - 60 C

**Note:**  
 CHS104NP Shade  
 Sold Separately/Use  
 40 Watt Frosted  
 Type "B" with Clip  
 On Shade

**Designer:**  
 E. F. Chapman

©EFC DESIGNS



**S5211BW**  
**Country Small**  
**Chandelier in**  
**Belgian White**  
Height: 26.75"  
Width: 36.5"  
Canopy: 5.5" Round

**Finishes:** BW

**Socket:**  
6 - Candelabra  
**Wattage:** 6 - 60 C

**Designer:**  
Studio VC



**S5212BW**  
**Country Large**  
**Chandelier in**  
**Belgian White**  
Height: 31"  
Width: 41"  
Canopy: 5.5" Round

**Finishes:** BW

**Socket:**  
6 - Candelabra  
**Wattage:** 6 - 60 C

**Designer:**  
Studio VC



**TOB5205BW**  
**Erika Two-Tier**  
**Chandelier in**  
**Belgian White**  
Height: 31"  
Width: 28.75"  
Canopy: 5" Round

**Finishes:** AI, BW

**Socket:**  
24 - Candelabra  
**Wattage:** 24 - 40 C

**Designer:**  
Thomas O'Brien



**TOB5206AI**  
**Erika Three-Tier**  
**Chandelier in**  
**Belgian White**  
Height: 38.75"  
Width: 39.5"  
Canopy: 5" Round

**Finishes:** AI, BW

**Socket:**  
36 - Candelabra  
**Wattage:** 36 - 40 C

**Designer:**  
Thomas O'Brien





**SK5022AI**  
**Reims Large Chandelier**  
in Aged Iron  
Height: 36.25"  
Width: 48.75"  
Canopy: 6" Round

**Finishes:** AI

**Socket:**  
9 - Candelabra  
**Wattage:** 9 - 60 C

**Designer:**  
Suzanne Kasler



**SK5012BW**  
**Seymour Large Chandelier in Belgian White**  
Height: 40.75"  
Width: 34"  
Canopy: 5" Round

**Finishes:** AI, BW

**Socket:**  
10 - Candelabra  
**Wattage:** 10 - 60 C

**Designer:**  
Suzanne Kasler

SK5012AI



**CHC1577OW-NP**  
**Lancaster Chandelier in Old White with Natural Paper Shades**  
Height: 58"  
Width: 41.5"  
Canopy: 5.75" Round

**Finishes:**  
AI, GI, OW  
**Shade Treatments:** NP  
**Shade Details:**  
4" x 5.5" x 5"

**Socket:**  
8 - Candelabra  
**Wattage:** 8 - 40 B

**Designer:**  
E. F. Chapman

©EFC DESIGNS

CHC1577GI-NP



**CHC1494GI**  
**Flemish Medium**  
**Round Chandelier**  
**in Gilded Iron**  
 Height: 36.5"  
 Width: 35.5"  
 Canopy: 5.5" Round

CHC1494AI

**Finishes:** AI, GI

**Socket:**  
 8 - Candelabra  
**Wattage:** 8 - 60 C

**Note:**  
 Use 40 Watt  
 Frosted Type "B"  
 with Clip On Shade.  
 CHS104 Shade  
 Sold Separately.

**Designer:**  
 E. F. Chapman

©EFC DESIGNS



**CHC1403AI-NP**  
**Belvedere Chandelier**  
**In Aged Iron with**  
**Natural Paper Shades**  
 Height: 48.25"  
 Width: 33"  
 Canopy: 5.75" Round

CHC1403GI-NP

**Finishes:** AI, GI  
**Shade Treatments:** NP  
**Shade Details:**  
 4" x 6" x 5"

**Socket:**  
 9 - Candelabra  
**Wattage:**  
 9 - 40 B

**Designer:**  
 E. F. Chapman

©EFC DESIGNS





**CHC1432BR**  
**Windsor Large Iron**  
**Two-Tier Chandelier**  
**in Black Rust**  
Height: 42"  
Width: 41"  
Canopy: 6" Round

**Finishes:** BR

**Socket:**  
12 - Candelabra  
**Wattage:** 12 - 60 C

**Designer:**  
E. F. Chapman

©EFC DESIGNS



**CHC1582AI-NP**  
Darlana Small Open  
Frame Chandelier in  
Aged Iron with  
Natural Paper Shades  
Height: 33.25"  
Width: 31.5"  
Canopy: 5.75" Round

**Finishes:** AI, GI  
**Shade Treatments:** NP  
**Shade Details:**  
3" x 3.5" x 3.5"

**Socket:**  
8 - Candelabra  
**Wattage:** 8 - 25 B

**Designer:**  
E. F. Chapman

©EFC DESIGNS



**CHC1583GI-NP**  
Darlana Medium Open  
Frame Chandelier in  
Gilded Iron with  
Natural Paper Shades  
Height: 47.75"  
Width: 45"  
Canopy: 5.75" Round

**Finishes:** AI, GI  
**Shade Treatments:** NP  
**Shade Details:**  
4" x 5" x 5"

**Socket:**  
8 - Candelabra  
**Wattage:** 8 - 25 B

**Designer:**  
E. F. Chapman

©EFC DESIGNS



**CHC5374GI**  
**Branch Chandelier**  
**in Gilded Iron**  
Height: 24.5"  
Width: 32.75"  
Canopy: 5.75" Round

**Finishes:** GI, OW

**Socket:**  
12 - Candelabra  
**Wattage:** 12 - 25 C

**Designer:**  
E. F. Chapman

©EFC DESIGNS



**CHC5374OW**



**CHC5470GI**  
**Branch Open Frame**  
**Chandelier in**  
**Gilded Iron**  
Height: 33.25"  
Width: 32.5"  
Canopy: 5.75" Round

**Finishes:** GI, OW

**Socket:**  
12 - Candelabra  
**Wattage:** 12 - 25 C

**Designer:**  
E. F. Chapman

©EFC DESIGNS



**CHC5470OW**



**TOB5119BSL-NP**  
**Channing Small Chandelier in Burnished Silver Leaf with Natural Paper Shades**  
 Height: 18.5"  
 Width: 28"  
 Canopy: 6" Round

**Finishes:**  
 BR/HAB, BSL, HAB  
**Shade Treatments:** NP  
**Shade Details:**  
 4.5" x 6" x 5.5"

**Socket:**  
 6 - Candelabra  
**Wattage:** 6 - 60 B

**Designer:**  
 Thomas O'Brien



**TOB5119HAB-NP**



**TOB5111BR/HAB-NP**  
**Chandler Large Chandelier in Blackened Rust with Hand-Rubbed Antique Brass and Natural Paper Shades**  
 Height: 21"  
 Width: 47" - 52"  
 (Oblong)  
 Canopy: 6" Round

**Finishes:**  
 BR/HAB, BSL  
**Shade Treatments:**  
 NP  
**Shade Details:**  
 4.5" x 6" x 5.5"

**Socket:**  
 15 - Candelabra  
**Wattage:** 15 - 60 B

**Designer:**  
 Thomas O'Brien



**TOB5109BSL-NP**  
**Chandelier Small**  
**Chandelier in Silver**  
**Leaf and Natural**  
**Paper Shades**  
Height: 20.5"  
Width: 36.75"  
Canopy: 6" Round

**Finishes:**  
BR/HAB, BSL  
**Shade Treatments:** NP  
**Shade Details:**  
4.5" x 6" x 5.5"

**Socket:** 10 - Candelabra  
**Wattage:** 10 - 60 B

**Designer:**  
Thomas O'Brien

**TOB5109BR/HAB-NP**



**TOB5111BSL-NP**



**CHC1120AN**  
**English 4-Light**  
**Chandelier in**  
**Antique Nickel**  
 Height: 12"  
 Width: 13"  
 Canopy: 5.5" Round

**Finishes:** AB, AN

**Socket:**  
 4 - Candelabra  
**Wattage:** 4 - 60 C

**Designer:**  
 E. F. Chapman

©EFC DESIGNS



CHC1120AB



**CHC1131AN**  
**Georgian Small**  
**Chandelier in**  
**Antique Nickel**  
 Height: 19"  
 Width: 28"  
 Canopy: 6" Round

**Finishes:** AB, AN

**Socket:**  
 6 - Candelabra  
**Wattage:** 6 - 60 C

**Note:**  
 CHS104NP Shade  
 Sold Separately/Use  
 40 Watt Frosted  
 Type "B" with  
 Clip On Shade

**Designer:**  
 E. F. Chapman

©EFC DESIGNS



CHC1131AB



**CHC1448AB**  
**Leaf and Arrow**  
**Small Chandelier**  
**in Antique-**  
**Burnished Brass**  
Height: 14"  
Width: 15.5"  
Canopy: 5.5" Round

**Finishes:**  
AB, BZ, BZ/AB

**Socket:**  
4 - Candelabra  
**Wattage:** 4 - 60 C

**Note:** Use 40  
Watt Frosted Type  
"B" with Clip  
On Shade

**Designer:**  
E. F. Chapman

©EFC DESIGNS



CHC1448BZ/AB



**CHC1447AB**  
**Leaf and Arrow**  
**Large Chandelier**  
**in Antique-**  
**Burnished Brass**  
Height: 21"  
Width: 34.75"  
Canopy: 5.75" Round

**Finishes:**  
AB, BZ, BZ/AB

**Socket:** 8 - Candelabra  
**Wattage:** 8 - 60 C

**Note:** Use 40  
Watt Frosted Type  
"B" with Clip  
On Shade

**Designer:**  
E. F. Chapman

©EFC DESIGNS



CHC1447BZ/AB



**SL5814BZ-NP**  
**Classic Mini Ring**  
**Chandelier in**  
**Bronze with Natural**  
**Paper Shades**  
 O/A Height: 38"  
 Fixture Height: 32"  
 Min. Custom Height: 38"  
 Width: 25.5"

Canopy: 5.5" Round

**Finishes:**  
 AN, BZ, HAB, PN  
**Shade Treatments:** NP  
**Shade Details:**  
 3" x 6.5" x 5"

**Socket:**  
 6 - Candelabra  
**Wattage:** 6 - 40 B

**Designer:**  
 E. F. Chapman

©EFC DESIGNS



**SL5812HAB-NP**  
**Classic Ring**  
**Chandelier in**  
**Hand-Rubbed Antique**  
**Brass with Natural**  
**Paper Shades**  
 O/A Height: 34"  
 Fixture Height: 28"  
 Width: 33.25"  
 Canopy: 5.5" Round

**Finishes:**  
 AN, BZ, HAB, PN  
**Shade Treatments:** NP  
**Shade Details:**  
 3" x 6.5" x 5"

**Socket:** 6 - Candelabra  
**Wattage:** 6 - 40 B

**Designer:**  
 E. F. Chapman

©EFC DESIGNS



**SL5813PN-NP**  
**Classic Two-Tier Ring**  
**Chandelier in Polished**  
**Nickel with Natural**  
**Paper Shades**  
 O/A Height: 54"  
 Fixture Height: 47"  
 Width: 45"  
 Canopy: 5.5" Round

**Finishes:**  
 AN, BZ, HAB, PN  
**Shade Treatments:** NP  
**Shade Details:**  
 3" x 6" x 5"

**Socket:**  
 9 - Candelabra  
**Wattage:** 9 - 40 B

**Designer:**  
 E. F. Chapman

©EFC DESIGNS





**CHC1463BR**  
**Dorset Large**  
**Two-Tier Chandelier**  
**in Black Rust**  
Height: 43"  
Width: 42"  
Canopy: 5.25" Round

**Finishes:** BR

**Socket:**  
9 - Candelabra  
**Wattage:** 9 - 60 C

**Note:**  
CHS114NP Shade  
Sold Separately

**Designer:**  
E. F. Chapman

©EFC DESIGNS



**CHC1462WI**  
**Dorset Large Torch**  
**Chandelier in**  
**Weathered Iron with**  
**Antique Gold Accents**  
Height: 45.5"  
Width: 57"  
Canopy: 5.25" Round

**Finishes:** WI

**Socket:** 9 - Keyless  
**Wattage:** 9 - 60 A

**Note:**  
CHS114NP Shade  
Sold Separately

**Designer:**  
E. F. Chapman

©EFC DESIGNS



**SK5102AI**  
**Margarite Iron**  
**Chandelier in Aged Iron**  
 Height: 20.5"  
 Width: 26"  
 Canopy: 5" Round

SK5102GI

**Finishes:** AI, GI

**Socket:** 7 - Candelabra  
**Wattage:** 7 - 60 C

**Note:** CHS104NP Shade  
 Sold Separately/Use 40  
 Watt Frosted Type "B"  
 with Clip On Shade

**Designer:**  
 Suzanne Kasler



**S5100AI**  
**Bracelet Large**  
**Chandelier in**  
**Aged Iron**  
 Height: 24.5"  
 Width: 34.75"  
 Canopy: 5.75" Round

S5100G

**Finishes:** AI, G

**Socket:** 6 - Keyless  
**Wattage:** 6 - 60 B

**Designer:**  
 Barry Goralnick



**NW5011VG**  
**Brittany Chandelier**  
**in Venetian Gold**  
Height: 37.25"  
Width: 37.25"  
Canopy: 6" Round

**Finishes:** VG, VS

**Socket:** 16 - Candelabra  
**Wattage:** 16 - 40 C

**Designer:**  
Niermann Weeks



**S5315GI-NP**  
**Etoile Round**  
**Chandelier in Gilded**  
**Iron with Natural**  
**Paper Shades**  
 Height: 25.5"  
 Width: 28"  
 Canopy: 5.5" Round

**Finishes:** BR, GI  
**Shade Treatments:** NP  
**Shade Details:**  
 4.5" x 5.5" x 6.5"

**Socket:**  
 4 - Candelabra  
**Wattage:** 4 - 60 B

**Designer:**  
 Ian Fowler



**S5315BR-NP**



**SK5016AI**  
**Dressage Large Oval**  
**Chandelier in Aged**  
**Iron with Leather**  
Height: 27.25"  
Width: 37"  
Canopy: 7.5" Round

**Finishes:** AI

**Socket:**  
8 - Candelabra  
**Wattage:** 8 - 60 C

**Designer:**  
Suzanne Kasler



**SK5019AI**  
**Dressage Round**  
**Chandelier In Aged**  
**Iron with Leather**  
Height: 38"  
Width: 37.25"  
Canopy: 7.5" Round

**Finishes:** AI

**Socket:**  
8 - Candelabra  
**Wattage:** 8 - 60 C

**Designer:**  
Suzanne Kasler



**HANGING SHADES**  
**PENDANTS CEILING**



**S5031BR-NP**  
**Aspen Small Hanging**  
**Shade in Black**  
**Rust with Natural**  
**Paper Shade**  
 Height: 11.5"  
 Width: 8.5"  
 Canopy: 6" Round

**Finishes:** BR  
**Shade Treatments:** NP  
**Shade Details:**  
 7.5" x 8.25" x 7"

**Socket:** Candelabra  
**Wattage:** 60 B

**Designer:**  
 Studio VC



**S5030BR-NP**  
**Aspen Large Hanging**  
**Shade in Black**  
**Rust with Natural**  
**Paper Shade**  
 Height: 20.75"  
 Width: 19.75"  
 Canopy: 6" Round

**Finishes:** BR  
**Shade Treatments:** NP  
**Shade Details:**  
 19" x 19" x 10"

**Socket:**  
 4 - Candelabra  
**Wattage:** 4 - 60 B

**Designer:**  
 Studio VC



**S5032BR-NP**  
**Aspen Small Conical**  
**Pendant in Black**  
**Rust with Natural**  
**Paper Shade**  
 Height: 20"  
 Width: 12.5"  
 Canopy: 6" Round

**Finishes:** BR  
**Shade Treatments:** NP  
**Shade Details:**  
 7.5" x 12" x 7.5"

**Socket:** Keyless  
**Wattage:** 75 A

**Designer:**  
 Ian Fowler



**S5033BR-NP**  
**Aspen Large Conical**  
**Pendant in Black**  
**Rust with Natural**  
**Paper Shade**  
 Height: 29"  
 Width: 21"  
 Canopy: 6" Round

**Finishes:** BR  
**Shade Treatments:** NP  
**Shade Details:**  
 12.25" x 20" x 11"

**Socket:** Keyless  
**Wattage:** 75 A

**Designer:**  
 Ian Fowler





**BBL5023BZ-S**  
**Westport Pendant**  
**in Bronze with**  
**Silk Shade**  
O/A Height: 39"  
Width: 18"  
Canopy: 4.5" Round

**Finishes:**  
BZ, PWT, SB  
**Shade Treatments:** S  
**Shade Details:**  
14" x 18" x 17.5"

**Socket:** 3 - Keyless  
**Wattage:** 3 - 60 A

**Note:** Custom Height  
Available/Cannot be  
Modified in Field

**Designer:**  
Barbara Barry



**BBL5025SS-S**

**Reflection Large**

**Pendant in**

**Soft Silver with**

**Silk Shade**

O/A Height: 40"

Min. Custom Height: 19"

Width: 24"

Canopy: 10" Round

**Finishes:**

BZ, SB, SS

**Shade Treatments:** S

**Shade Details:**

24" x 24" x 13"

**Socket:** 4 - Keyless

**Wattage:** 4 - 75 A

**Note:** Custom Height

Available/Knob is for decorative purposes.

**Designer:**

Barbara Barry



**TOB5011PN-NP**  
Reed Pendant in  
Polished Nickel with  
Natural Paper Shade  
O/A Height: 29.5"  
Min. Custom Height: 14"  
Width: 22"  
Canopy: 5.25" Round

**Finishes:**  
AN, BZ, HAB, PN  
**Shade Treatments:**  
NP, NP/BT  
**Shade Details:**  
22" x 22" x 7.5"

**Socket:** 2 - Keyless  
**Wattage:** 2 - 100 A

**Note:** Custom Height  
Available/Cannot Be  
Modified In The Field

**Designer:**  
Thomas O'Brien



**TOB5011AN-NP**



**TOB5011HAB-NP**



**TOB5011BZ-NP/BT**



**BBL5015SS-S**  
**Simple Scallop**  
**Chandelier in**  
**Soft Silver with**  
**Silk Shade**  
Height: 21"  
Width: 25"  
Canopy: 8.5" Round

**Finishes:**  
BZ, SB, SS  
**Shade Treatments:** S  
**Shade Details:**  
22" x 25" x 17.5"

**Socket:** 5 - Candelabra  
**Wattage:** 5 - 60 B

**Designer:**  
Barbara Barry



**BBL5016SS-S**  
**Simple Scallop**  
**Pendant in Soft Silver**  
**with Silk Shade**  
O/A Height: 21.5"  
Min. Custom Height: 16.5"  
Width: 15.75"  
Canopy: 7" Round

**Finishes:** BZ, SB, SS  
**Shade Treatments:** S  
**Shade Details:**  
14" x 15.75" x 11.5"

**Socket:**  
3 - Candelabra  
**Wattage:** 3 - 60 B

**Note:** Custom  
Height Available

**Designer:**  
Barbara Barry



**BBL5016BZ-S**



**AH5027PN-PL**  
**Peter Crown Hanging**  
**Shade in Polished**  
**Nickel with Natural**  
**Percale Shade**  
Height: 19.75"  
Width: 20.5"  
Canopy: 5.5" Round

**Finishes:** GM, NB, PN  
**Shade Treatments:** PL

**Socket:** 2 - Keyless  
**Wattage:** 2 - 60 A

**Designer:**  
Alexa Hampton



**AH5027GM-PL**



**BBL5033SS-S**  
**Perfect Pleat Lantern**  
 in Soft Silver with  
 Silk Pleated Shade  
 Height: 25.5"  
 Width: 13"  
 Canopy: 6.5" Round

**Finishes:**  
 BZ, PWT, SB, SS  
**Shade Treatments: S**  
**Shade Details:**  
 13" x 13" x 21"

**Socket:** 2 - Keyless  
**Wattage:** 2 - 60 A

**Designer:**  
 Barbara Barry



**BBL5033BZ-S**



**BBL5032SS-S**  
**Perfect Pleat Pendant**  
 in Soft Silver with  
 Silk Shade  
 Height: 21.25"  
 Width: 23"  
 Canopy: 6.5" Round

**Finishes:**  
 BZ, PWT, SB, SS  
**Shade Treatments: S**  
**Shade Details:**  
 22" x 23" x 18.5"

**Socket:** 2 - Keyless  
**Wattage:** 2 - 75 A

**Designer:**  
 Barbara Barry



**BBL5032SB-S**



**ARN5213HAB-L**  
**Niles Pendant in**  
**Hand-Rubbed**  
**Antique Brass and**  
**Linen Shade**  
Height: 21"  
Width: 18.25"  
Canopy: 4.5" Octagon

**Finishes:**  
BZ, HAB, PN  
**Shade Treatments:** L  
**Shade Details:**  
19.75" x 19.75" x 18"  
Octagon

**Socket:**  
4 - Candelabra  
**Wattage:** 4 - 60 C

**Designer:**  
AERIN



**BBL5030SS-L**  
Westport Chandelier  
in Soft Silver with  
Linen Shade  
Height: 21"  
Width: 23"  
Canopy: 7" Round

**Finishes:**  
BZ, PWT, SB, SS

**Shade Treatments:** L  
**Shade Details:**  
21" x 23" x 16"

**Socket:** 4 - Keyless  
**Wattage:** 4 - 60 A

**Designer:**  
Barbara Barry

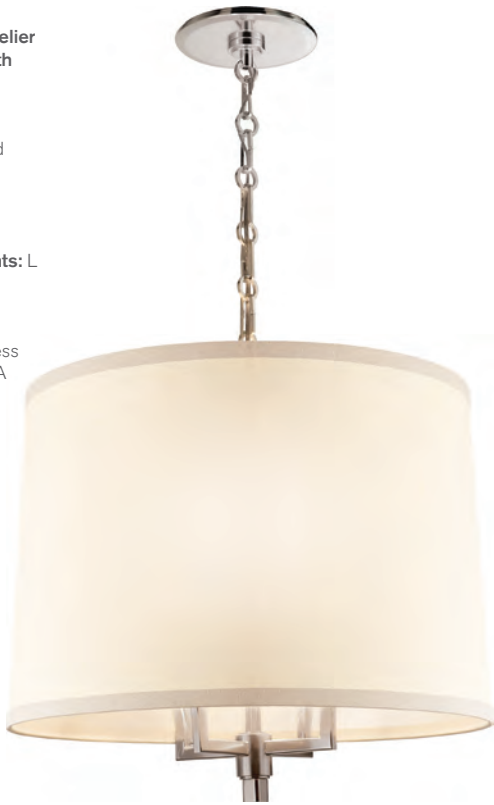

**BBL5030PWT-L**



**BBL5030SB-L**



**BBL5030BZ-L**





**SL5820PN-NP**  
Square Tube Hanging  
Shade in Polished  
Nickel with Natural  
Paper Shade  
Height: 21"  
Width: 24"  
Canopy: 5.75" Square

**Finishes:**  
AN, BZ, HAB, PN  
**Shade Treatments:** NP  
**Shade Details:**  
20" x 24" x 11"

**Socket:** 6 - Candelabra  
**Wattage:** 6 - 60 B

**Designer:**  
E. F. Chapman

©EFC DESIGNS

SL5820AN-NP



SL5820HAB-NP



SL5820BZ-NP



**TOB5135PN-NP**  
**Calliope Pendant in Polished Nickel with Natural Paper Shade**  
 Height: 23"  
 Width: 24"  
 Canopy: 5" Round

**Finishes:**  
 BR/HAB, HAB,  
 PN, SN/AN  
**Shade Treatments:** NP  
**Shade Details:**  
 21" x 24" x 12"

**Socket:**  
 6 - Candelabra  
**Wattage:** 6 - 60 B

**Designer:**  
 Thomas O'Brien



**TOB5135SN/AN-NP**



**TOB5135HAB-NP**



**TOB5135BR/HAB-NP**



**SL5818PN-NP**  
Classic Candle Hanging  
Light in Polished  
Nickel with Natural  
Paper Shade  
Height: 19"  
Width: 14"  
Canopy: 5.5" Round

**Finishes:**  
AN, BZ, HAB, PN  
**Shade Treatments:** NP  
**Shade Details:**  
12.5" x 14" x 8"

**Socket:**  
3 - Candelabra  
**Wattage:** 3 - 60 C

**Designer:**  
E. F. Chapman

©EFC DESIGNS



**SL5818AN-NP**



**SL5818HAB-NP**



**SL5818BZ-NP**





**CHC1480PN-L**  
**Grosvenor Single Pendant**  
**in Polished Nickel**  
**with Linen Shade**  
O/A Height: 54.5"  
Min. Custom Height: 19"  
Width: 15"  
Canopy: 6" Round

**Finishes:**  
AB, AN, BZ, PN  
**Shade Treatments:** L  
**Shade Details:**  
12" x 15" x 10.5"

**Socket:** 2 - Keyless  
**Wattage:** 2 - 75 A

**Note:** Custom  
Height Available

**Designer:**  
E. F. Chapman

©EFC DESIGNS



CHC1480AN-L



CHC1480AB-L



CHC1480BZ-L



**CHC1483PN-L**  
Grosvenor Large  
Single Pendant in  
Polished Nickel  
with Linen Shade  
O/A Height: 24"  
Fixture Height: 20.5"  
Width: 24"  
Canopy: 6" Round

**Finishes:**  
AB, AN, BZ, PN  
**Shade Treatments:** L  
**Shade Details:**  
20" x 24" x 15"

**Socket:** 3 - Keyless  
**Wattage:** 3 - 60 A

**Designer:**  
E. F. Chapman

©EFC DESIGNS

CHC1483AN-L

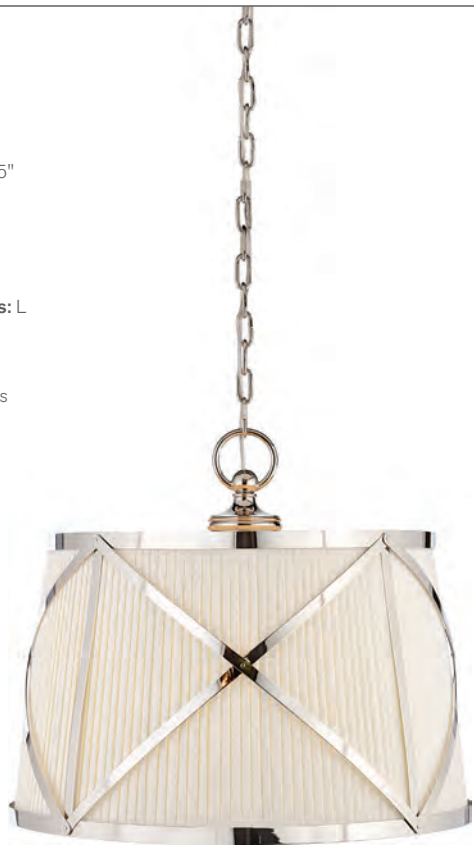

CHC1483AB-L



CHC1483BZ-L



**CHC5101AN-L**  
**Sloane Single Shop**  
**Light in Antique Nickel**  
**with Linen Shade**  
O/A Height: 49"  
Min. Custom Height: 21"  
Width: 15.5"

**Finishes:**  
AB, AN, BZ  
**Shade Treatments:**  
AB, AN, BZ, L  
**Shade Details:**  
11.5" x 15.5" x 10"

**Socket:** 2 - Keyless  
**Wattage:** 2 - 60 A

**Note:** Custom  
Height Available

**Designer:**  
E.F. Chapman

©EFC DESIGNS



**CHC5101BZ-L**



**CHC5101AN-AN**



**CHC5101AB-AB**



**AH5210NB**  
**Lily Hanging Shade**  
**in Natural Brass**  
O/A Height: 46"  
Width: 15"  
Canopy: 4.25" Round

**Finishes:**  
GM, NB, PN  
**Shade Details:**  
9" x 15" x 12"

**Socket:**  
3 - Candelabra  
**Wattage:** 3 - 60 C

**Note:** Custom  
Height Available

**Designer:**  
Alexa Hampton





**AH5216NB**  
Basil Small Hanging  
Shade in Natural Brass  
with Acrylic Diffuser  
Height: 12"  
Width: 19"  
Canopy: 6.5" Round

**Finishes:** GM, NB, PN  
**Glass Options:** FG

**Socket:** 2 - Keyless  
**Wattage:** 2 - 75 A

**Designer:**  
Alexa Hampton



**AH5216GM**



**AH5215PN**  
Markos Hanging Shade  
in Polished Nickel  
Height: 16.25"  
Width: 26"  
Canopy: 6.5" Round

**Finishes:** BZ, NB, PN

**Socket:**  
4 - Keyless  
**Wattage:** 4 - 60 A

**Designer:**  
Alexa Hampton



**AH5215NB**



**ARN5306BSL**  
**Arabelle Pendant in**  
**Burnished Silver Leaf**  
Fixture Height: 18.25"  
Width: 28"  
Canopy: 5.75" Flower

**Finishes:** BSL, G

**Socket:** 5 - Keyless  
**Wattage:** 5 - 60 A

**Designer:**  
AERIN



**ARN5306G**



**S5047BSL**  
Hatton Small  
Pendant in Burnished  
Silver Leaf  
Height: 16"  
Width: 14.75"  
Canopy: 6" Round

Finishes: AI, BSL, G

Socket:  
4 - Candelabra  
Wattage: 4 - 60 C

Designer:  
Barry Goralnick



S5047G



**S5048BSL**  
Hatton Large  
Pendant in Burnished  
Silver Leaf  
Height: 24.5"  
Width: 31.25"  
Canopy: 6" Round

Finishes: AI, BSL, G

Socket:  
4 - Candelabra  
Wattage: 4 - 60 C

Designer:  
Barry Goralnick

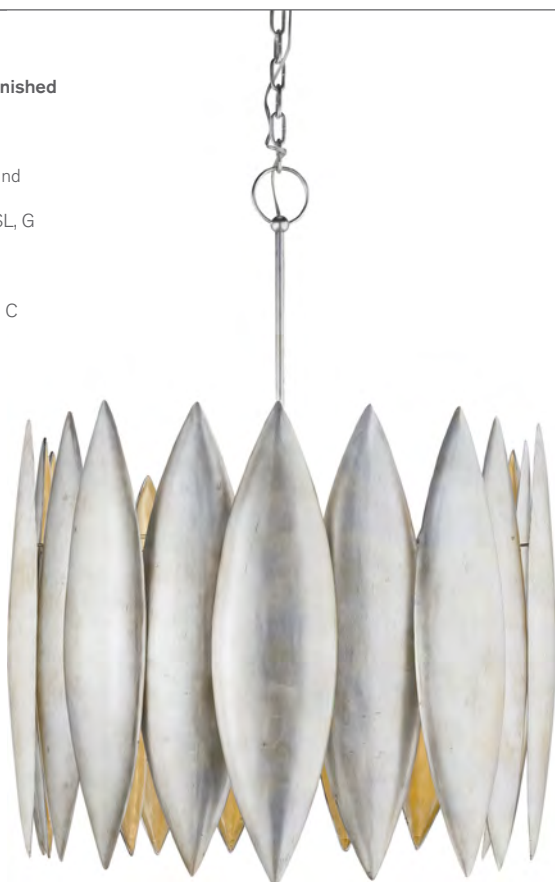

S5048G



**SK5537GI-L**  
**Alexandra Large**  
**Pendant in Gilded Iron**  
**with Linen Shade**  
Height: 22.5"  
Width: 37"  
Canopy: 5" Round

**Finishes:** AI, BSL, GI  
**Shade Treatments:** L  
**Shade Details:**  
33.5" x 33.5" x 19"

**Socket:** 4 - Keyless  
**Wattage:** 4 - 60 A

**Designer:**  
Suzanne Kasler



**SK5536GI-L**  
**Alexandra Medium**  
**Pendant in Gilded Iron**  
**with Linen Shade**  
Height: 15.25"  
Width: 24.75"  
Canopy: 5" Round

**Finishes:** AI, BSL, GI  
**Shade Treatments:** L  
**Shade Details:**  
22.5" x 22.5" x 12.25"

**Socket:** 4 - Keyless  
**Wattage:** 4 - 60 A

**Designer:**  
Suzanne Kasler

SK5536AI-L



**SK5538BSL-L**  
**Alexandra Narrow Pendant**  
**in Burnished Silver Leaf**  
**with Linen Shade**  
Height: 28.5"  
Width: 19"  
Canopy: 5" Round

**Finishes:** AI, BSL, GI  
**Shade Treatments:** L  
**Shade Details:**  
17" x 17" x 25.25"

**Socket:** 2 - Keyless  
**Wattage:** 2 - 60 A

**Designer:**  
Suzanne Kasler

SK5538GI-L

SK5538AI-L



**ARN5011BSL**  
**Hampton Large**  
**Pendant in Burnished**  
**Silver Leaf**  
Fixture Height: 10.5"  
Width: 25.5"  
Canopy: 6" Round

ARN5011G

**Finishes:**  
BSL, G, PW

**Socket:**  
6 - Candelabra  
**Wattage:** 6 - 60 C

**Designer:**  
AERIN



**ARN5001PW**  
**Hampton Pendant**  
**in Plaster White**  
Height: 9.25"  
Width: 21.5"  
Canopy: 6" Round

ARN5001BSL

ARN5001G

**Finishes:**  
BSL, G, PW

**Socket:**  
3 - Candelabra  
**Wattage:** 3 - 60 C

**Designer:**  
AERIN





**CHC2149ALB**  
**Fluted Band Medium Pendant in Alabaster**  
 Height: 30.5"  
 Width: 18.25"  
 Canopy: 6.25" Round

**Finishes:** ALB

**Socket:** 2 - Keyless  
**Wattage:** 2 - 60 A

**Designer:**  
 E. F. Chapman

©EFC DESIGNS



**ARN5202HAB/ALB**  
**O'Connor Pendant in Hand-Rubbed Antique Brass and Alabaster**  
 Height: 30"  
 Width: 16"  
 Canopy: 5.5" Round

**Finishes:** HAB  
**Shade Treatments:** ALB

**Socket:**  
 3 - Candelabra  
**Wattage:** 3 - 60 C

**Designer:**  
 AERIN



**ARN5203HAB-ALB**  
**O'Connor Large Pendant in Hand-Rubbed Antique Brass with Alabaster**  
 Height: 32"  
 Width: 24"  
 Canopy: 5.25" Round

**Finishes:** HAB  
**Shade Treatments:** ALB

**Socket:** 3 - Keyless  
**Wattage:** 3 - 60 C

**Designer:**  
 AERIN

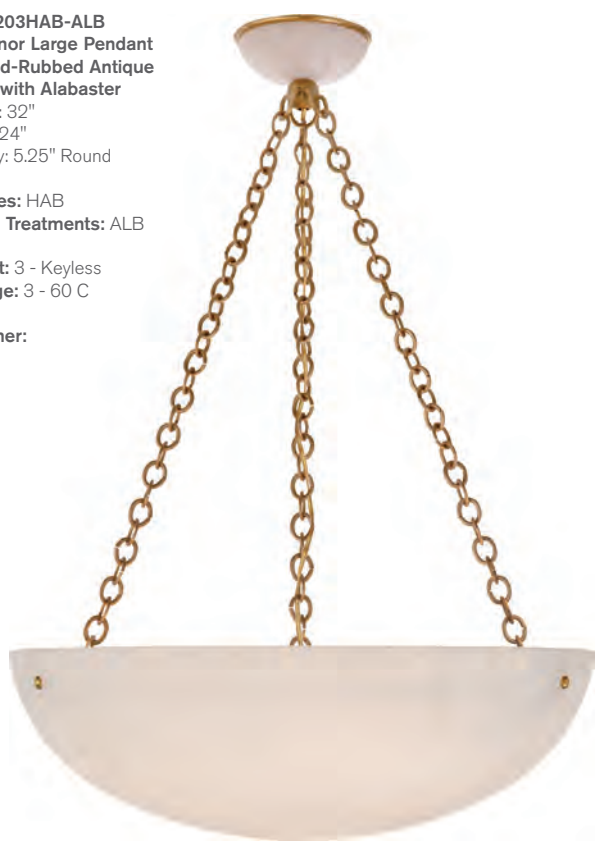



**AH5000ALB**  
**Charles Small**  
**Pendant in Alabaster**  
**and Bronze**  
Height: 21.5"  
Width: 14"  
Canopy: 5" Round

**Finishes:** ALB

**Socket:**  
3 - Candelabra  
**Wattage:** 3 - 40 C

**Designer:**  
Alexa Hampton



**AH5002ALB**  
**Charles Pendant in**  
**Alabaster and Bronze**  
Height: 23"  
Width: 28"  
Canopy: 5.25" Round

**Finishes:** ALB

**Socket:** 3 - Keyless  
**Wattage:** 3 - 60 B

**Note:** Custom  
Height Available

**Designer:**  
Alexa Hampton



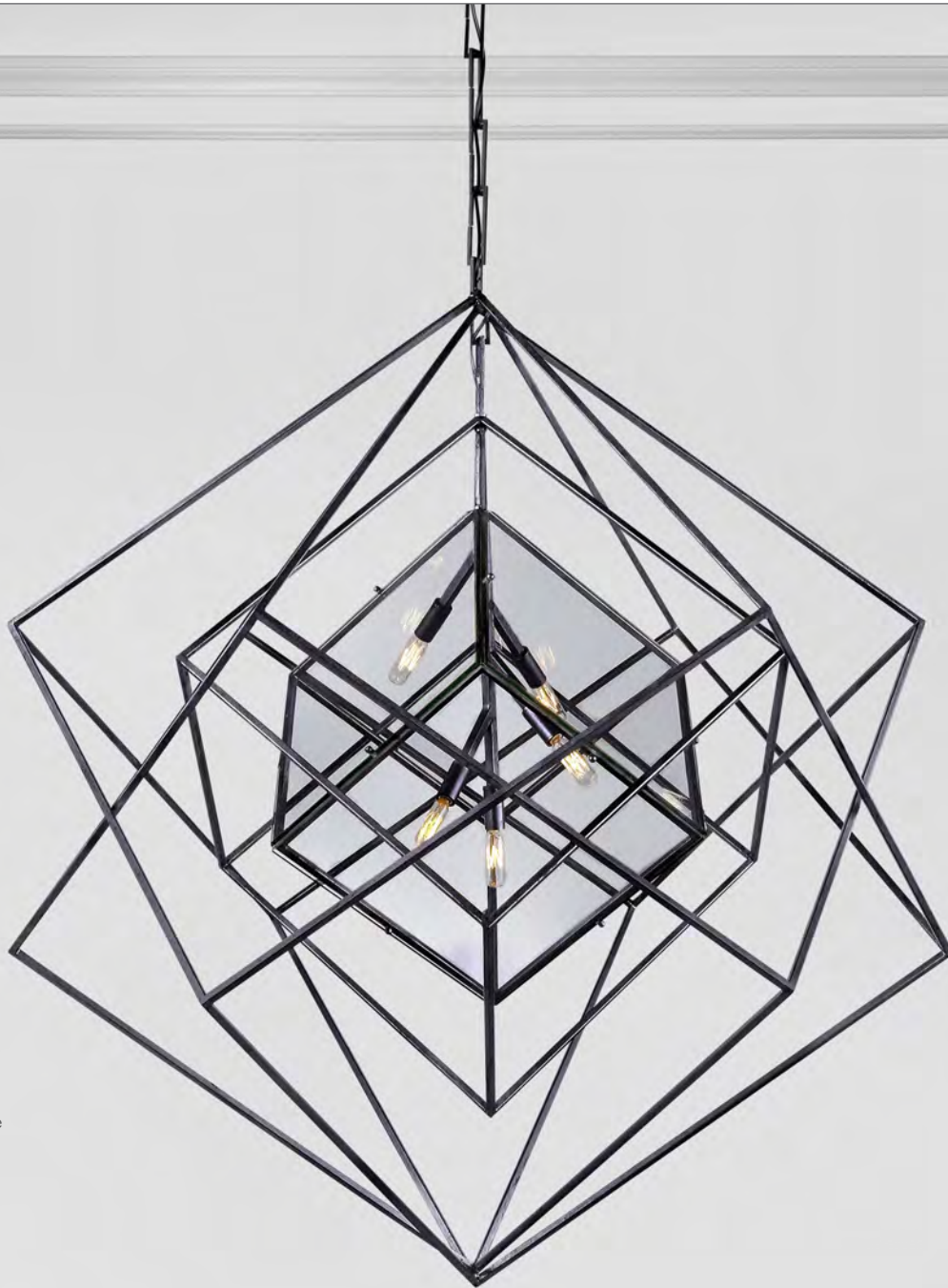

**KW5022AI-CG**  
**Cubist Large**  
**Chandelier in**  
**Aged Iron**  
Fixture Height: 51"  
Width: 44.5"  
Canopy: 4.5" Square

**Finishes:** AI, G  
**Glass Options:** CG

**Socket:**  
5 - Candelabra  
**Wattage:** 5 - 60 B

**Designer:**  
Kelly Wearstler

**KW5020G-CG**  
**Cubist Small**  
**Chandelier in Gild**  
Fixture Height: 21.5"  
Width: 22"  
Canopy: 4.5" Square

**Finishes:** AI, G  
**Glass Options:** CG

**Socket:** Keyless  
**Wattage:** 60 A

**Designer:**  
Kelly Wearstler



**KW5020AI-CG**



**KW5021G-CG**  
**Cubist Medium**  
**Chandelier in Gild**  
Fixture Height: 36"  
Width: 31.25"  
Canopy: 4.5" Square

**Finishes:** AI, G  
**Glass Options:** CG

**Socket:**  
4 - Candelabra  
**Wattage:** 4 - 60 B

**Designer:**  
Kelly Wearstler



**KW5021AI-CG**



**KW5074G**  
**Strada Medium Oval**  
**Pendant in Gild**  
Height: 25.5"  
Width: 38"  
Canopy: 4.75" Round

**Finishes:**  
Al, BSL, G, PN

**Socket:**  
20 - Candelabra  
**Wattage:** 20 - 60 C

**Designer:**  
Kelly Wearstler



**KW5075AI**  
**Strada Large Oval**  
**Pendant in Aged Iron**  
Height: 36"  
Width: 50"  
Canopy: 4.75" Round

**Finishes:**  
Al, BSL, G, PN

**Socket:**  
20 - Candelabra  
**Wattage:** 20 - 60 C

**Designer:**  
Kelly Wearstler

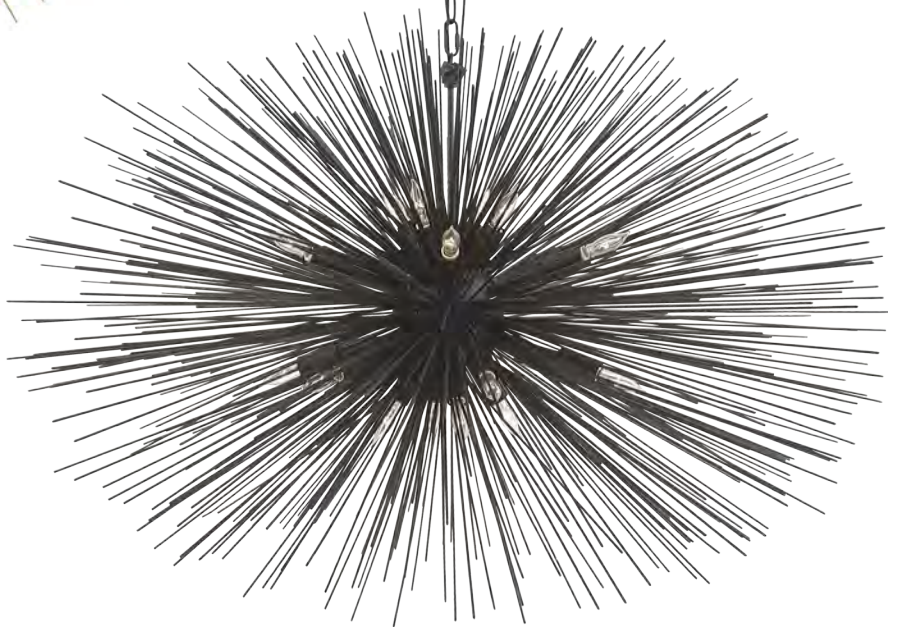

**KW5071G**  
**Strada Medium Round**  
**Pendant in Gild**  
Height: 28.25"  
Width: 28"  
Canopy: 4.75" Round

**Finishes:**  
AI, BSL, G, PN

**Socket:**  
20 - Candelabra  
**Wattage:** 20 - 60 C

**Designer:**  
Kelly Wearstler



**KW5072AI**  
**Strada Large Round**  
**Pendant in Aged Iron**  
Height: 40.75"  
Width: 40.25"  
Canopy: 4.75" Round

**Finishes:**  
AI, BSL, G, PN

**Socket:**  
20 - Candelabra  
**Wattage:** 20 - 60 C

**Designer:**  
Kelly Wearstler



**KW5077BSL**  
**Strada Small Pendant**  
**in Burnished Silver Leaf**  
Height: 23.75"  
Width: 9.25"  
Canopy: 4.75" Round

**Finishes:**  
AI, BSL, G, PN

**Socket:** Keyless  
**Wattage:** 60 A

**Designer:**  
Kelly Wearstler



**KW5077G**



**KW5077AI**





**TOB5014BZ/HAB-HAB**  
**Goodman Large Hanging**  
**Lamp in Bronze and**  
**Hand-Rubbed Antique**  
**Brass with Hand-Rubbed**  
**Antique Brass Shade**  
O/A Height: 48.5"  
Min. Custom Height: 26"  
Width: 24.5"  
Canopy: 5.25" Round

**Finishes:**

AN, BZ, BZ/HAB, HAB

**Shade Treatments:**

AN, AW, BZ, HAB,  
NP, NP/BT

**Shade Details:**

7.5" x 24" x 22.5"

**Socket:** 2 - Keyless

**Wattage:** 2 - 100 A

**Note:** Custom Height  
Available/Shade is  
White Inside

**Designer:**

Thomas O'Brien



TOB5014BZ/HAB-AW



TOB5014AN-AN



**TOB5091HAB-HAB**  
Goodman Medium Hanging  
Light in Hand-Rubbed  
Antique Brass with  
Hand-Rubbed Antique  
Brass Shade  
O/A Height: 43"  
Min. Custom Height: 20"  
Width: 18"  
Canopy: 5.25" Round

**Finishes:**  
AN, BZ, BZ/HAB, HAB  
**Shade Treatments:**  
AN, AW, BZ, HAB,  
NP, NP/BT  
**Shade Details:**  
6.5" x 18" x 15.5"

**Socket:** Keyless  
**Wattage:** 100 A

**Note:** Custom Height  
Available/Shade is  
White Inside

**Designer:**  
Thomas O'Brien

TOB5091HAB-AW



TOB5091HAB-BZ

TOB5091BZ-NP/BT

TOB5091AN-AN





**TOB5089HAB-HAB**  
**Goodman Petite Hanging**  
**Shade in Hand-Rubbed**  
**Antique Brass with**  
**Hand-Rubbed Antique**  
**Brass Shade**  
 O/A Height: 38"  
 Fixture Height: 12"  
 Min. Custom Height: 15"  
 Width: 10"  
 Canopy: 5.25" Round

**Finishes:**  
 AN, BZ, BZ/HAB, HAB  
**Shade Treatments:**  
 AN, AW, BZ, HAB,  
 NP, NP/BT  
**Shade Details:**  
 3" x 10" x 9.75"

**Socket:** Candelabra  
**Wattage:** 60 C

**Note:** Custom  
 Height Available

**Designer:**  
 Thomas O'Brien

TOB5089AN-AN

TOB5089BZ-BZ

TOB5089HAB-AW



**TOB5090HAB-HAB**  
**Goodman Small Hanging**  
**Light in Hand-Rubbed**  
**Antique Brass with**  
**Hand-Rubbed Antique**  
**Brass Shade**  
 O/A Height: 36"  
 Min. Custom Height: 17"  
 Width: 15"  
 Canopy: 5.25" Round

**Finishes:**  
 AN, BZ, BZ/HAB, HAB  
**Shade Treatments:**  
 AN, AW, BZ, HAB,  
 NP, NP/BT  
**Shade Details:**  
 4.75" x 15" x 12.75"

**Socket:** Keyless  
**Wattage:** 100 A

**Note:** Custom Height  
 Available/Shade is  
 White Inside

**Designer:**  
 Thomas O'Brien

TOB5090AN-AN

TOB5090BZ-BZ

TOB5090HAB-NP



**ARN5033HAB-L**  
**Clarkson Small**  
**Single Pendant in**  
**Hand-Rubbed**  
**Antique Brass with**  
**Linen Shade**  
O/A Height: 36"  
Fixture Height: 16"  
Width: 9.75"  
Canopy: 4.75" Round

**Finishes:** HAB, PN  
**Shade Treatments:** L  
**Shade Details:**  
5.25" x 9.75" x 11"

**Socket:** Keyless  
**Wattage:** 75 A

**Designer:**  
AERIN

ARN5033PN-L



**ARN5034HAB-L**  
**Clarkson Large**  
**Single Pendant in**  
**Hand-Rubbed**  
**Antique Brass with**  
**Linen Shade**  
O/A Height: 63.5"  
Fixture Height: 30.5"  
Width: 18.25"  
Canopy: 4.75" Round

**Finishes:** HAB, PN  
**Shade Treatments:** L  
**Shade Details:**  
10" x 18.25" x 20.5"

**Socket:** 2 - Keyless  
**Wattage:** 2 - 75 A

**Designer:**  
AERIN

ARN5034PN-L



**ARN5350PW**  
**Agnes Small Pendant**  
 in Plaster White  
 with Gild Interior  
 O/A Height: 50.25"  
 Fixture Height: 13.5"  
 Min. Custom Height: 19"  
 Width: 10"  
 Canopy: 4.25" Round

**Finishes:**  
 BSL, G, MBK, PW

**Socket:** Keyless  
**Wattage:** 75 A

**Note:** Cannot be  
 Modified in the Field

**Designer:**  
 AERIN

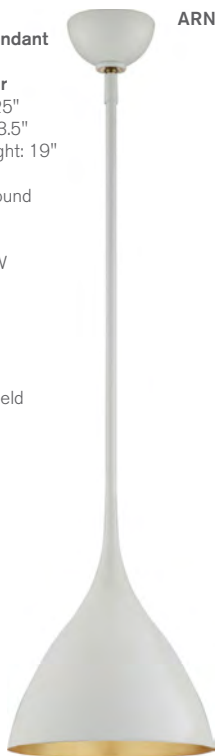

**ARN5350BSL**



**ARN5350G**



**ARN5350MBK**



**ARN5351PW**  
**Agnes Medium Pendant**  
 in Plaster White with  
 Gild Interior  
 O/A Height: 59.5"  
 Fixture Height: 22.75"  
 Min. Custom Height: 30"  
 Width: 18"  
 Canopy: 4.25" Round

**Finishes:**  
 BSL, G, MBK, PW

**Socket:** Keyless  
**Wattage:** 75 A

**Note:** Cannot be  
 Modified in the Field

**Designer:**  
 AERIN

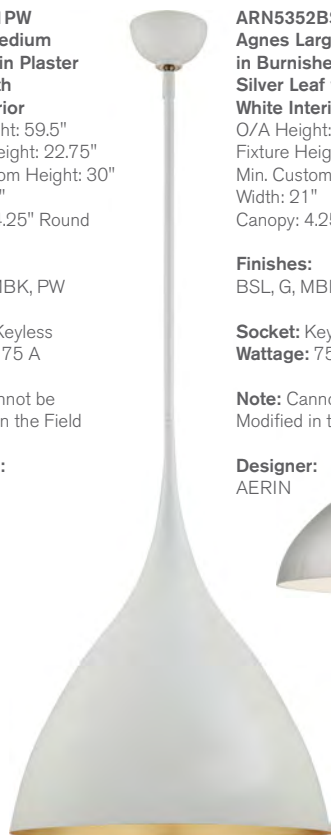

**ARN5352BSL**  
**Agnes Large Pendant**  
 in Burnished Silver Leaf with  
 White Interior  
 O/A Height: 50.5"  
 Fixture Height: 13.5"  
 Min. Custom Height: 21"  
 Width: 21"  
 Canopy: 4.25" Round

**Finishes:**  
 BSL, G, MBK, PW

**Socket:** Keyless  
**Wattage:** 75 A

**Note:** Cannot be  
 Modified in the Field

**Designer:**  
 AERIN



**ARN5351G**



**ARN5352MBK**



**TOB5000BZ**  
**Eugene Large**  
**Pendant in Bronze**  
O/A Height: 156"  
Fixture Height: 19"  
Min. Custom Height: 24"  
Width: 21"  
Canopy: 3.5" Round

**Finishes:**  
AN, AW, BZ, HAB

**Socket:** Keyless  
**Wattage:** 150 A

**Note:** Requires  
Smaller Outlet Box

**Designer:**  
Thomas O'Brien



**TOB5012HAB**  
**Eugene Small Pendant**  
**in Hand-Rubbed**  
**Antique Brass**  
O/A Height: 149"  
Fixture Height: 12"  
Min. Custom Height: 17"  
Width: 12"  
Canopy: 3.5" Round

**Finishes:**  
AN, AW, BZ, HAB

**Socket:** Keyless  
**Wattage:** 150 A

**Note:** Requires  
Smaller Outlet Box

**Designer:**  
Thomas O'Brien



**TOB5013AN**  
**Eugene Medium**  
**Pendant in**  
**Antique Nickel**  
O/A Height: 152"  
Fixture Height: 15"  
Min. Custom Height: 20"  
Width: 15.5"  
Canopy: 3.5" Round

**Finishes:**  
AN, AW, BZ, HAB

**Socket:** Keyless  
**Wattage:** 150 A

**Note:** Requires  
Smaller Outlet Box

**Designer:**  
Thomas O'Brien



**TOB5043HAB-WHT**  
**Henry Industrial**  
**Hanging Light in**  
**Hand-Rubbed**  
**Antique Brass with**  
**White Shade**  
O/A Height: 42"  
Fixture Height: 12"  
Min. Custom Height: 20"  
Width: 18"  
Canopy: 5.25" Round

**Finishes:** HAB, PN  
**Shade Treatments:**  
G, WHT

**Socket:** Keyless  
**Wattage:** 75 A

**Note:** Custom  
Height Available

**Designer:**  
Thomas O'Brien



**TOB5043HAB-G**



**TOB5042PN-WHT**  
**Henry Industrial**  
**Hanging Light in**  
**Polished Nickel**  
**and White Shade**  
**with Industrial**  
**Prismatic Glass**  
O/A Height: 54.5"  
Fixture Height: 24"  
Min. Custom Height: 31"  
Width: 18"  
Canopy: 5.25" Round

**Finishes:** HAB, PN  
**Shade Treatments:**  
G, WHT

**Socket:** 2 - Keyless  
**Wattage:** 2 - 75 A

**Note:** Custom  
Height Available

**Designer:**  
Thomas O'Brien



**TOB5042HAB-G**



**TOB5261PN-FG**  
**Patrick Medium Pendant**  
**in Polished Nickel**  
**with Frosted Glass**  
O/A Height: 40"  
Fixture Height: 14"  
Min. Custom Height: 24"  
Width: 18"  
Canopy: 4.75" Round

**Finishes:**  
BZ, HAB, PN  
**Glass Options:** FG

**Socket:** Keyless  
**Wattage:** 100 A

**Note:** Custom  
Height Available

**Designer:**  
Thomas O'Brien



TOB5261BZ-FG



**TOB5262BZ-FG**  
**Patrick Large**  
**Pendant in Bronze**  
**with Frosted Glass**  
O/A Height: 44"  
Fixture Height: 18"  
Min. Custom Height: 28"  
Width: 20"  
Canopy: 4.75" Round

**Finishes:**  
BZ, HAB, PN  
**Glass Options:** FG

**Socket:** 2 - Keyless  
**Wattage:** 2 - 75 A

**Note:** Custom  
Height Available

**Designer:**  
Thomas O'Brien



TOB5262HAB-FG









**CHC5136PN-WG**  
Country Industrial  
Large Pendant in  
Polished Nickel with  
White Glass Shade  
O/A Height: 59"  
Min. Custom Height: 28"  
Width: 19.5"  
Canopy: 5.5" Round

**Finishes:**  
AB, AN, BZ, PN  
**Shade Treatments:**  
AB, AN, BZ, PN, WG  
**Shade Details:**  
9.5" x 19.5"

**Socket:** Keyless  
**Wattage:** 100 A

**Note:** Custom  
Height Available

**Designer:**  
E.F. Chapman

©EFC DESIGNS



CHC5136AN-AN



**CHC5136AB-AB**  
Country Industrial  
Large Pendant in  
Antique-Burnished  
Brass with  
Antique-Burnished  
Brass Shade  
O/A Height: 59"  
Min. Custom Height: 28"  
Width: 19.5"  
Canopy: 5.5" Round

**Finishes:**  
AB, AN, BZ, PN  
**Shade Treatments:**  
AB, AN, BZ, PN, WG  
**Shade Details:**  
9.5" x 19.5"

**Socket:** Keyless  
**Wattage:** 100 A

**Note:** Custom  
Height Available

**Designer:**  
E.F. Chapman

©EFC DESIGNS



CHC5136BZ-WG



**CHC5133PN-PN**  
**Country Industrial**  
**Small Pendant in**  
**Polished Nickel with**  
**Polished Nickel Shade**  
 O/A Height: 59"  
 Min. Custom Height: 28"  
 Width: 14"  
 Canopy: 5.5" Round

CHC5133PN-WG

CHC5133AB-AB

CHC5133AB-WG

**Finishes:**  
 AB, AN, BZ, PN  
**Shade Treatments:**  
 AB, AN, BZ, PN, WG  
**Shade Details:**  
 9.5" x 14"

**Socket:** Keyless  
**Wattage:** 100 A

**Note:** Custom  
 Height Available

**Designer:**  
 E.F. Chapman

©EFC DESIGNS



**CHC5133BZ-WG**  
**Country Industrial**  
**Small Pendant in**  
**Bronze with White**  
**Glass Shade**  
 O/A Height: 59"  
 Min. Custom Height: 28"  
 Width: 14"  
 Canopy: 5.5" Round

CHC5133BZ-BZ

CHC5133AN-WG

CHC5133AN-AN

**Finishes:**  
 AB, AN, BZ, PN  
**Shade Treatments:**  
 AB, AN, BZ, PN, WG  
**Shade Details:**  
 9.5" x 14"

**Socket:** Keyless  
**Wattage:** 100 A

**Note:** Custom  
 Height Available

**Designer:**  
 E.F. Chapman

©EFC DESIGNS



**CHC5132PN-PN**  
**Sloane Single Pendant**  
in Polished Nickel  
O/A Height: 44"  
Min. Custom Height: 21"  
Width: 10"  
Canopy: 5.5" Round

**Finishes:**  
AB, AN, BZ, PN  
**Shade Treatments:**  
AB, AN, BZ, CG,  
PN, WG

**Socket:** Keyless  
**Wattage:** 100 A

**Note:** Custom  
Height Available

**Designer:**  
E.F. Chapman

©EFC DESIGNS

CHC5132AB-AB

CHC5132BZ-BZ

CHC5132AN-AN



**CHC5132PN-CG**  
**Sloane Single Pendant**  
in Polished Nickel with  
Clear Glass  
O/A Height: 44"  
Min. Custom Height: 21"  
Width: 10"  
Canopy: 5.5" Round

**Finishes:**  
AB, AN, BZ, PN  
**Shade Treatments:**  
AB, AN, BZ, CG,  
PN, WG

**Socket:** Keyless  
**Wattage:** 100 A

**Note:** Custom  
Height Available

**Designer:**  
E.F. Chapman

©EFC DESIGNS

CHC5132AB-WG

CHC5132BZ-WG

CHC5132AN-WG



**SL5175PN-PN1**  
**Yoke Large Pendant**  
**in Polished Nickel**  
O/A Height: 55.75"  
Min. Custom Height: 24"  
Width: 17.5"  
Canopy: 5.5" Round

**Finishes:**  
AN, BZ, HAB, PN  
**Shade Treatments:**  
AN, BZ, HAB, PN

**Socket:** Keyless  
**Wattage:** 150 A

**Note:** Custom  
Height Available

**Designer:**  
E. F. Chapman

©EFC DESIGNS



SL5175HAB-HAB1



**SL5175PN-PN2**  
**Yoke Small Pendant**  
**in Polished Nickel**  
O/A Height: 55.75"  
Min. Custom Height: 24"  
Width: 11"  
Canopy: 5.5" Round

**Finishes:**  
AN, BZ, HAB, PN  
**Shade Treatments:**  
AN, BZ, HAB, PN

**Socket:** Keyless  
**Wattage:** 150 A

**Note:** Custom  
Height Available

**Designer:**  
E. F. Chapman

©EFC DESIGNS



SL5175HAB-HAB2



SL5175BZ-BZ2



**SL5174PN-WG**  
**Yoke Mini Pendant with Polished Nickel with White Glass Shade**  
 O/A Height: 47"  
 Min. Custom Height: 18"  
 Width: 5.5"  
 Canopy: 4.5" Round

**Finishes:**  
 AN, BZ, HAB, PN  
**Shade Treatments:**  
 AN, BZ, HAB, PN, WG

**Socket:** Keyless  
**Wattage:** 60 A

**Note:** Custom Height Available

**Designer:**  
 E.F. Chapman

©EFC DESIGNS



SL5174HAB-WG



SL5174BZ-WG



**SL5174AN-AN**  
**Yoke Mini Pendant in Antique Nickel with Antique Nickel Shade**  
 O/A Height: 47"  
 Min. Custom Height: 18"  
 Width: 5.5"  
 Canopy: 4.5" Round

**Finishes:**  
 AN, BZ, HAB, PN  
**Shade Treatments:**  
 AN, BZ, HAB, PN, WG

**Socket:** Keyless  
**Wattage:** 60 A

**Note:** Custom Height Available

**Designer:**  
 E.F. Chapman

©EFC DESIGNS



SL5174HAB-HAB



SL5174BZ-BZ





**SL5125PN-WG1**  
**Boston Pendant**  
 in Polished Nickel  
 with White Glass  
 Slant Shade  
 O/A Height: 47"  
 Min. Custom Height: 14"  
 Width: 10"  
 Canopy: 4.5" Round

**Finishes:**  
 AN, BZ, HAB, PN  
**Shade Treatments:**  
 AN, BZ, CG, HAB, MG,  
 MG3, PN, WG, WG3

**Socket:** Keyless  
**Wattage:** 100 A

**Note:** Custom  
 Height Available

**Designer:**  
 E.F. Chapman

©EFC DESIGNS

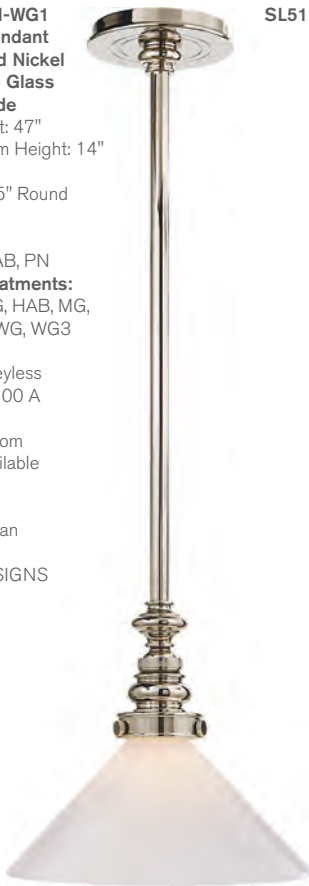

SL5125AN-CG1



SL5125BZ-WG1



SL5125HAB-CG1



**SL5125PN/SLD-PN**  
**Boston Pendant**  
 in Polished Nickel  
 with Mini  
 Slant Shade  
 O/A Height: 47"  
 Min. Custom Height: 14"  
 Width: 7.25"  
 Canopy: 4.5" Round

**Finishes:**  
 AN, BZ, HAB, PN  
**Shade Treatments:**  
 AN, BZ, CG, HAB, MG,  
 MG3, PN, WG, WG3

**Socket:** Keyless  
**Wattage:** 100 A

**Note:** Custom  
 Height Available

**Designer:**  
 E.F. Chapman

©EFC DESIGNS



SL5125HAB/  
 SLD-HAB



SL5125BZ/  
 SLD-BZ



SL5125AN/  
 SLD-AN



**TOB5154AN-SG**  
**Gale Petite Pendant**  
 in Antique Nickel  
 with Seeded Glass  
 O/A Height: 38.5"  
 Fixture Height: 11"  
 Min. Custom Height: 20"  
 Width: 7.5"  
 Canopy: 5" Round

**Finishes:**  
 AN, BZ, HAB, PN  
**Glass Options:**  
 SG, WG

**Socket:** Keyless  
**Wattage:** 60 A

**Note:** Custom Height  
 Available/Slope  
 Mount Included

**Designer:**  
 Thomas O'Brien



TOB5154HAB-SG



TOB5154BZ-SG



**TOB5155AN-WG**  
**Gale Small Pendant**  
 in Antique Nickel  
 with White Glass  
 O/A Height: 44"  
 Fixture Height: 17.25"  
 Min. Custom Height: 24"  
 Width: 11.25"  
 Canopy: 5" Round

**Finishes:**  
 AN, BZ, HAB, PN  
**Glass Options:**  
 SG, WG

**Socket:** Keyless  
**Wattage:** 75 A

**Note:** Custom Height  
 Available/Slope  
 Mount Included

**Designer:**  
 Thomas O'Brien



TOB5155HAB-WG



TOB5155BZ-WG





**TOB5156PN-WG**  
**Gale Medium Pendant**  
**in Polished Nickel**  
**with White Glass**  
O/A Height: 51"  
Fixture Height: 24"  
Min. Custom Height: 32"  
Width: 15.5"  
Canopy: 5" Round

**Finishes:**  
AN, BZ, HAB, PN  
**Glass Options:**  
SG, WG

**Socket:** Keyless  
**Wattage:** 75 A

**Note:** Custom Height  
Available/Slope  
Mount Included

**Designer:**  
Thomas O'Brien



TOB5156HAB-WG



TOB5156BZ-WG



**TOB5157PN-SG**  
**Gale Large Pendant**  
**in Polished Nickel**  
**with Seeded Glass**  
O/A Height: 55"  
Fixture Height: 27.5"  
Min. Custom Height: 30"  
Width: 17.5"  
Canopy: 5" Round

**Finishes:**  
AN, BZ, HAB, PN  
**Glass Options:**  
SG, WG

**Socket:** Keyless  
**Wattage:** 100 A

**Note:** Custom Height  
Available/Slope  
Mount Included

**Designer:**  
Thomas O'Brien



TOB5157HAB-SG



TOB5157BZ-SG



**CHC2201PN-CG**  
**Darlana 16" Pendant**  
**in Polished Nickel**  
**with Clear Glass**  
Height: 13.5"  
Width: 16.5"  
Canopy: 6" Round

**Finishes:** AI, PN

**Socket:**  
4 - Candelabra  
**Wattage:** 4 - 40 C

**Designer:**  
E. F. Chapman

©EFC DESIGNS

CHC2201AI-CG



**CHC2202PN-CG**  
**Darlana 24" Pendant**  
**in Polished Nickel**  
**with Clear Glass**  
Height: 20.5"  
Width: 24.5"  
Canopy: 6" Round

**Finishes:** AI, PN

**Socket:**  
4 - Candelabra  
**Wattage:** 4 - 60 C

**Designer:**  
E. F. Chapman

©EFC DESIGNS

CHC2202AI-CG



**S5010PN**  
**Belden Single Pendant**  
**in Polished Nickel**  
**with Clear Glass**  
O/A Height: 40"  
Fixture Height: 12"  
Min. Custom Height: 20"  
Width: 5.5"  
Canopy: 5" Square

**Finishes:** AI, PN

**Socket:** Keyless  
**Wattage:** 40 T

**Note:** Custom  
Height Available

**Designer:**  
Ian Fowler



S5010AI



**S5012PN**  
**Belden Wide Pendant**  
**in Polished Nickel**  
**with Clear Glass**  
O/A Height: 57"  
Fixture Height: 18"  
Min. Custom Height: 30"  
Width: 16"  
Canopy: 5" Square

**Finishes:** AI, PN

**Socket:** 4 - Keyless  
**Wattage:** 4 - 40 T

**Note:** Custom  
Height Available

**Designer:**  
Ian Fowler



S5012AI





**CHC5055PN-WG**  
**Easterly Small Pendant**  
in Polished Nickel  
with White Glass  
O/A Height: 51.5"  
Fixture Height: 11"  
Min. Custom Height: 18"  
Width: 5.75"  
Canopy: 5.75" Square

**Finishes:**  
AB, BZ, PN  
**Glass Options:** WG

**Socket:** Keyless  
**Wattage:** 75 A

**Note:** Custom  
Height Available

**Designer:**  
E. F. Chapman

©EFC DESIGNS



CHC5055AB-WG



CHC5055BZ-WG



**CHC5058PN-WG**  
**Easterly Large Pendant**  
in Polished Nickel  
with White Glass  
O/A Height: 55"  
Fixture Height: 15"  
Min. Custom Height: 22"  
Width: 8"  
Canopy: 5.75" Square

**Finishes:**  
AB, BZ, PN  
**Glass Options:** WG

**Socket:** Keyless  
**Wattage:** 75 A

**Note:** Custom  
Height Available

**Designer:**  
E. F. Chapman

©EFC DESIGNS



CHC5058AB-WG



CHC5058BZ-WG



**TOB5055PN-WG**  
**Billy Pendant in Polished Nickel with White Glass**  
O/A Height: 50.5"  
Fixture Height: 22.5"  
Min. Custom Height: 30"  
Width: 13.25"  
Canopy: 4.75" Round

**Finishes:**  
AN, BZ, HAB, PN  
**Glass Options:** WG

**Socket:** 2 - Keyless  
**Wattage:** 2 - 75 A

**Note:** Custom Height Available/Slope Mount Included

**Designer:**  
Thomas O'Brien

**TOB5055AN-WG**



**TOB5055HAB-WG**



**TOB5055BZ-WG**



**TOB5062BZ/HAB-WG**  
**Hicks Small Pendant**  
in Bronze and Hand-  
Rubbed Antique Brass  
with White Glass  
Height: 11.75"  
Width: 8.5"  
Canopy: 4.75" Round

**Finishes:**  
AN, BZ/HAB,  
HAB, PN  
**Glass Options:** WG

**Socket:** Keyless  
**Wattage:** 100 A

**Designer:**  
Thomas O'Brien



**TOB5064BZ/HAB-WG**  
Hicks Extra Large  
Pendant in Bronze and  
Hand-Rubbed Antique  
Brass with White Glass  
Height: 22"  
Width: 16"  
Canopy: 4.75" Round

**Finishes:**  
AN, BZ/HAB,  
HAB, PN  
**Glass Options:** WG

**Socket:** 2 - Keyless  
**Wattage:** 2- 75 A

**Designer:**  
Thomas O'Brien



**TOB5064PN-WG**



**TOB5064HAB-WG**





**TOB5062AN-WG**  
**Hicks Small Pendant**  
in Antique Nickel  
with White Glass  
Height: 11.75"  
Width: 8.5"  
Canopy: 4.75" Round

**Finishes:**  
AN, BZ/HAB,  
HAB, PN  
**Glass Options:** WG

**Socket:** Keyless  
**Wattage:** 100 A

**Designer:**  
Thomas O'Brien

TOB5062HAB-WG

TOB5062BZ/HAB-WG



**TOB5063PN-WG**  
**Hicks Large Pendant**  
in Polished Nickel  
with White Glass  
Height: 15"  
Width: 12.5"  
Canopy: 4.75" Round

**Finishes:**  
AN, BZ/HAB,  
HAB, PN  
**Glass Options:** WG

**Socket:** 2 - Keyless  
**Wattage:** 2 - 75 A

**Designer:**  
Thomas O'Brien

TOB5063HAB-WG

TOB5063BZ/HAB-WG





**TOB5226PN/G2-CG**  
**Katie Acorn Pendant**  
in Polished Nickel  
with Clear Glass  
Height: 13"  
Width: 10.5"  
Canopy: 5.25" Round

**Finishes:**  
BZ, HAB, PN  
**Glass Options:**  
CG, SG, WG

**Socket:** Keyless  
**Wattage:** 75 A

**Note:** Item Includes  
3 ft. of Chain

**Designer:**  
Thomas O'Brien

**TOB5226HAB/G2-CG**



**TOB5226BZ/G2-SG**



**TOB5226PN/G4-WG**  
**Katie Globe Pendant**  
in Polished Nickel  
with White Glass  
Height: 14"  
Width: 12"  
Canopy: 5.25" Round

**Finishes:**  
BZ, HAB, PN  
**Glass Options:**  
CG, SG, WG

**Socket:** Keyless  
**Wattage:** 75 A

**Note:** Item Includes  
3 ft. of Chain

**Designer:**  
Thomas O'Brien

**TOB5226HAB/G4-SG**



**TOB5226BZ/G4-CG**



**TOB5226PN/G1-WG**  
**Katie Bell Jar Pendant**  
 in Polished Nickel  
 with White Glass  
 Height: 13.5"  
 Width: 8"  
 Canopy: 5.25" Round

**Finishes:**  
 BZ, HAB, PN  
**Glass Options:**  
 CG, SG, WG

**Socket:** Keyless  
**Wattage:** 75 A

**Note:** Item Includes  
 3 ft. of Chain

**Designer:**  
 Thomas O'Brien



**TOB5226HAB/G1-CG**



**TOB5226BZ/G1-SG**



**TOB5226PN/G6-WG**  
**Katie Conical Pendant**  
 in Polished Nickel  
 with White Glass  
 Height: 14.75"  
 Width: 15.75"  
 Canopy: 5.25" Round

**Finishes:**  
 BZ, HAB, PN  
**Glass Options:**  
 CG, SG, WG

**Socket:** Keyless  
**Wattage:** 75 A

**Note:** Item Includes  
 3 ft. of Chain

**Designer:**  
 Thomas O'Brien



**TOB5226HAB/G6-SG**



**TOB5226BZ/G6-CG**



**TOB5226PN/G5-CG**  
**Katie Dome Pendant**  
in Polished Nickel  
with Clear Glass  
Height: 10.75"  
Width: 12"  
Canopy: 5.25" Round

**Finishes:**  
BZ, HAB, PN  
**Glass Options:**  
CG, SG, WG

**Socket:** Keyless  
**Wattage:** 75 A

**Note:** Item Includes  
3 ft. of Chain

**Designer:**  
Thomas O'Brien

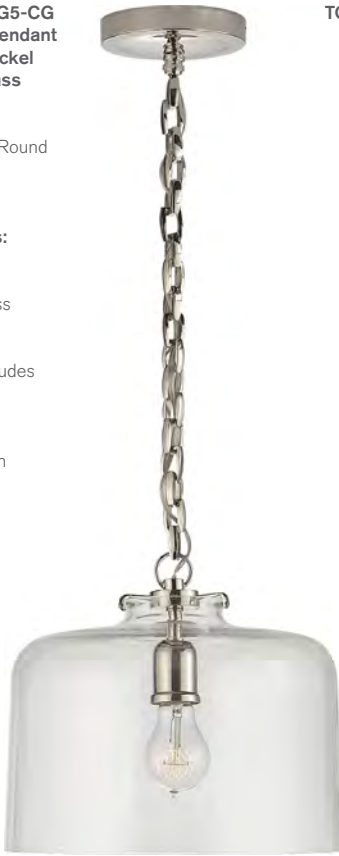

**TOB5226HAB/G5-CG**



**TOB5226BZ/G5-SG**



**TOB5226PN/G3-WG**  
**Katie Cylinder Pendant**  
in Polished Nickel  
with White Glass  
Height: 15.75"  
Width: 7"  
Canopy: 5.25" Round

**Finishes:**  
BZ, HAB, PN  
**Glass Options:**  
CG, SG, WG

**Socket:** Keyless  
**Wattage:** 75 A

**Note:** Item Includes  
3 ft. of Chain

**Designer:**  
Thomas O'Brien



**TOB5226HAB/G3-SG**



**TOB5226BZ/G3-CG**



**CHC5473PN-CG**  
**Covington Pendant in**  
**Polished Nickel with**  
**Clear Dome Glass**  
Height: 11.25"  
Width: 8"  
Canopy: 5.5" Round

**Finishes:**  
AB, AN, BZ, PN

**Socket:** Keyless  
**Wattage:** 100 A

**Designer:**  
E. F. Chapman

©EFC DESIGNS

CHC5473AN-CG



CHC5473AB-CG



CHC5473BZ-CG



**CHC5474PN-CG**  
Covington Pendant  
in Polished Nickel  
with Clear Ribbed  
Narrow Glass  
Height: 12.5"  
Width: 4.5"  
Canopy: 5.5" Round

**Finishes:**  
AB, AN, BZ, PN

**Socket:** Keyless  
**Wattage:** 60 T

**Designer:**  
E. F. Chapman

©EFC DESIGNS

CHC5474AN-CG

CHC5474AB-CG

CHC5474BZ-CG



**CHC5472PN-CG**  
Covington Pendant  
in Polished Nickel  
with Clear Ribbed  
Wide Glass  
Height: 11.5"  
Width: 6.5"  
Canopy: 5.5" Round

**Finishes:**  
AB, AN, BZ, PN  
**Glass Options:** CG

**Socket:** Keyless  
**Wattage:** 60 T

**Designer:**  
E. F. Chapman

©EFC DESIGNS

CHC5472AN-CG

CHC5472AB-CG

CHC5472BZ-CG



**TOB5143AN-CG**  
Garey Small Single  
Light in Antique  
Nickel with Industrial  
Prismatic Glass  
O/A Height: 36.25"  
Min. Custom Height: 26"  
Width: 10.5"  
Canopy: 7" Round

**Finishes:**  
AN, BZ, HAB, PN  
**Glass Options:** CG

**Socket:** Keyless  
**Wattage:** 100 A

**Note:** Custom  
Height Available

**Designer:**  
Thomas O'Brien

TOB5143HAB-CG



TOB5143BZ-CG



**TOB5144PN-CG**  
Garey Large Single  
Light in Polished  
Nickel with Industrial  
Prismatic Glass  
O/A Height: 39"  
Min. Custom Height: 29"  
Width: 16.75"  
Canopy: 7" Round

**Finishes:**  
AN, BZ, HAB, PN  
**Glass Options:** CG

**Socket:** Keyless  
**Wattage:** 100 A

**Note:** Custom  
Height Available

**Designer:**  
Thomas O'Brien

TOB5144HAB-CG



TOB5144AN-CG





**TOB5150BZ-WG**  
**Milton Road Flush**  
**Mount in Bronze**  
**with White Glass**  
O/A Height: 36.25"  
Min. Custom Height: 26"  
Width: 10.5"  
Canopy: 7" Round

**Finishes:**  
AN, BZ, HAB, PN  
**Glass Options:** CG

**Socket:** Keyless  
**Wattage:** 100 A

**Note:** Custom  
Height Available

**Designer:**  
Thomas O'Brien





**TOB5159PN-WG**  
**Eden Large Pendant**  
**in Polished Nickel**  
**with White Glass**  
O/A Height: 33.25"  
Fixture Height: 16"  
Width: 10.25"  
Canopy: 6" Round

**Finishes:** HAB, PN  
**Glass Options:** WG

**Socket:** 3 - Keyless  
**Wattage:** 3 - 40 A

**Designer:**  
Thomas O'Brien



TOB5159HAB-WG



**TOB5160PN-WG**  
**Eden Medium Pendant**  
**in Polished Nickel**  
**with White Glass**  
O/A Height: 36.5"  
Fixture Height: 21"  
Width: 9"  
Canopy: 5.875" Round

**Finishes:** HAB, PN  
**Glass Options:** WG

**Socket:** 3 - Keyless  
**Wattage:** 3 - 60 A

**Note:** Custom  
Height Available

**Designer:**  
Thomas O'Brien



TOB5160HAB-WG



# LINEAR CEILING

**CHC2166AI**  
**Darlana Linear**  
**Pendant in Aged Iron**  
Height: 25.5"  
Width: 54"  
Canopy: 6" x 26.5"  
Rectangle

**Finishes:** AI, GI, PN

**Socket:**  
6 - Candelabra  
**Wattage:** 6 - 60 C

**Designer:**  
E. F. Chapman

©EFC DESIGNS



**S5015PN**  
**Belden Linear Pendant**  
**in Polished Nickel**  
**with Clear Glass**

O/A Height: 53"  
Fixture Height: 14"  
Min. Custom Height: 26"  
Width: 56"  
Canopy: 4.5" x 44"  
Rectangle

**Finishes:** Al, PN  
**Glass Options:** CG

**Socket:** 6 - Keyless  
**Wattage:** 6 - 60 T

**Note:** Custom  
Height Available

**Designer:**  
Ian Fowler

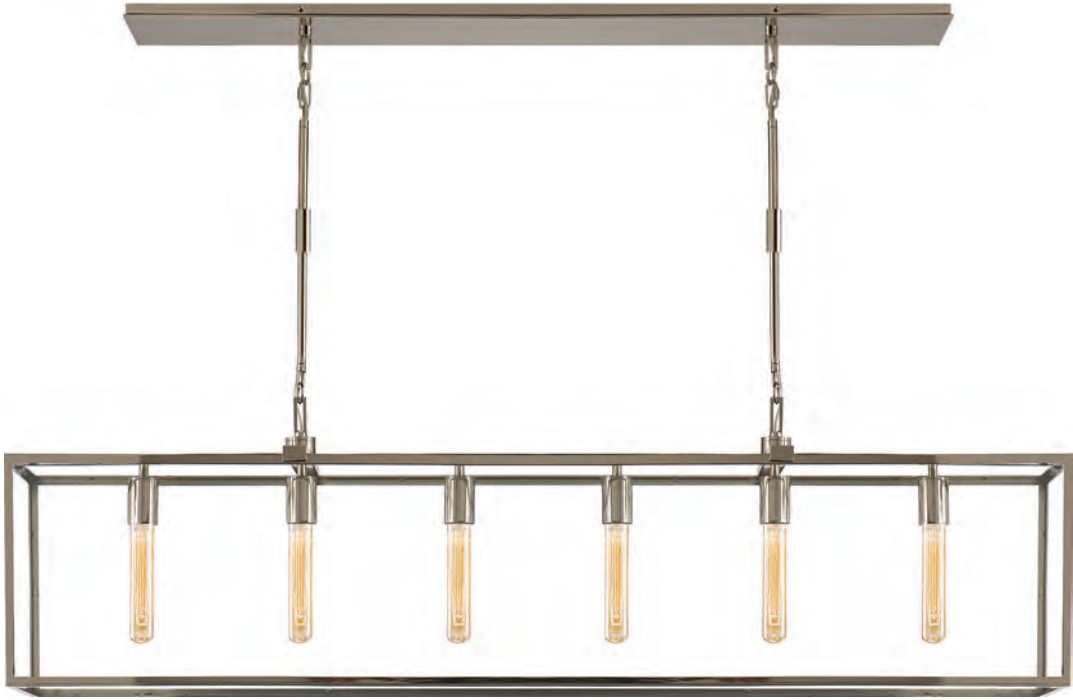

**S5015AI**

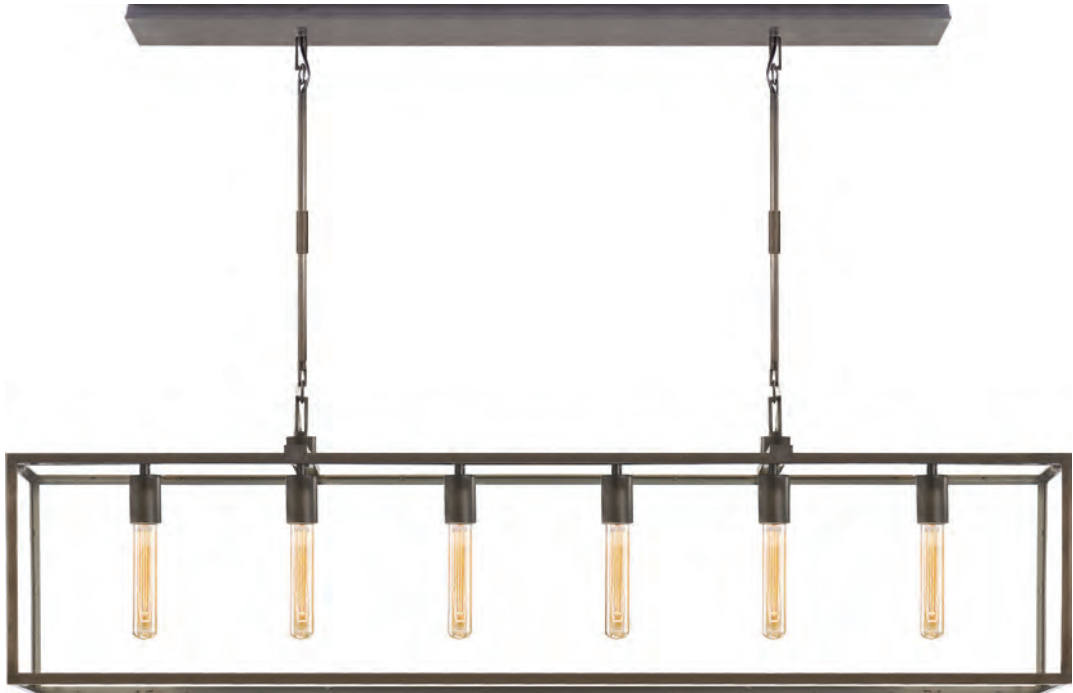

S5015PN



**KW5550G-FRG**  
**Utopia Large Linear**  
**Pendant in Gild**  
**with Fractured Glass**  
O/A Height: 31.5"  
Fixture Height: 7.5"  
Width: 60.25"  
Canopy: 4" x 36"  
Rectangle

**Finishes:** AI, G  
**Glass Options:** FRG

**Socket:** 3 - Keyless  
**Wattage:** 3 - 75 A

**Designer:**  
Kelly Wearstler



**KW5550AI-FRG**





**KW5553G-WG**  
**Utopia Large Linear**  
**Bath Pendant in**  
**Gild with White Glass**  
Height: 15.5"  
Width: 28"  
Canopy: 4" Round

**Finishes:** AI, G  
**Glass Options:** WG

**Socket:** 2 - Keyless  
**Wattage:** 2 - 60 B

**Designer:**  
Kelly Wearstler



**KW5553AI-WG**





**TOB5004AN-NP**  
**Bryant Small Billiard**  
**in Antique Nickel with**  
**Natural Paper Shades**  
O/A Height: 32"  
Min. Custom Height: 20"  
Width: 36"  
Canopy: 3.5" x 36"  
Rectangle

**Finishes:**  
AN, BZ, HAB, PN  
**Shade Treatments:** NP  
**Shade Details:**  
6.5" x 8" x 7.5"

**Socket:** 3 - Keyless  
**Wattage:** 3 - 75 A

**Note:** Custom  
Height Available

**Designer:**  
Thomas O'Brien



**TOB5005BZ-NP**  
**Bryant Large**  
**Billiard in Bronze**  
**with Natural**  
**Paper Shades**  
O/A Height: 32"  
Min. Custom Height: 20"  
Width: 60"  
Canopy: 3.5" x 60"  
Rectangle

**Finishes:**  
AN, BZ, HAB, PN  
**Shade Treatments:** NP  
**Shade Details:**  
10.5" x 12" x 7.5"

**Socket:** 3 - Keyless  
**Wattage:** 3 - 75 A

**Note:** Custom  
Height Available

**Designer:**  
Thomas O'Brien



**BBL5035SB-S**  
**French Cuff Double**  
**Pendant in Soft Brass**  
**with Silk Shades**  
O/A Height: 49.75"  
Fixture Height: 18"  
Min. Custom Height: 32"  
Width: 34.25"  
Canopy: 8" Square

**Finishes:**  
BZ, PN, PWT, SB, SS  
**Shade Treatments:** S  
**Shade Details:**  
12.5" x 13" x 12"

**Socket:** 2 - Keyless  
**Wattage:** 2 - 60 A

**Note:** Custom  
Height Available

**Designer:**  
Barbara Barry



**BBL5035BZ-S**





KARA WALKER PICTURES FROM ANOTHER TIME  
Bernd and Hilla Becher Lange  
Woman in the Mirror Richard



**SL5816PN-NP**  
**Classic Billiard**  
**Light in Polished**  
**Nickel with Natural**  
**Paper Shades**  
Height: 32"  
Width: 42"  
Canopy: 5.5" Round

**Finishes:**  
AN, BZ, HAB, PN  
**Shade Treatments:** NP  
**Shade Details:**  
12.5" x 14" x 8"

**Socket:**  
6 - Candelabra  
**Wattage:** 6 - 60 C

**Designer:**  
E. F. Chapman

©EFC DESIGNS



**SL5816BZ-NP**



**CHC1497AI-NP**  
**Flemish Small Linear**  
**Pendant in Aged**  
**Iron with Natural**  
**Paper Shades**

Height: 41.5"  
 Min. Custom Height: 25"  
 Width: 32"  
 Canopy: 5.5" Round

**Finishes:** AI, GI  
**Shade Treatments:** NP  
**Shade Details:**  
 13" x 14.5" x 5.5"  
 Oval

**Socket:**  
 4 - Candelabra  
**Wattage:** 4 - 40 B

**Note:** Custom Height  
 Available/Sloped  
 Ceiling Kit Included

**Designer:**  
 E. F. Chapman

©EFC DESIGNS



**CHC1498GI-NP**  
**Flemish Large Linear**  
**Pendant in Gilded**  
**Iron with Natural**  
**Paper Shades**

Height: 42.5"  
 Min. Custom Height: 29"  
 Width: 44.25"  
 Canopy: 5.5" Round

**Finishes:** AI, GI  
**Shade Treatments:** NP  
**Shade Details:**  
 15" x 16.5" x 8" Oval

**Socket:**  
 4 - Candelabra  
**Wattage:** 4 - 60 B

**Note:** Custom Height  
 Available/Sloped  
 Ceiling Kit Included

**Designer:**  
 E. F. Chapman

©EFC DESIGNS

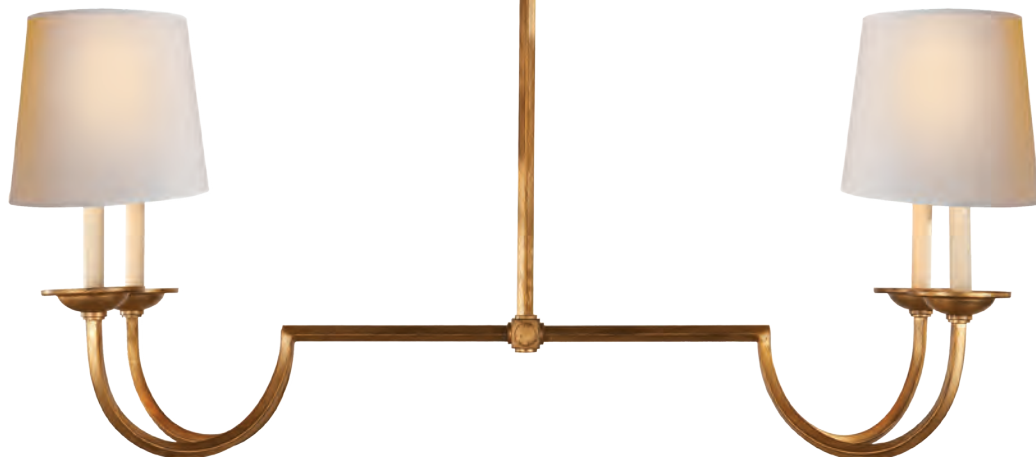



**SL5863HAB**  
**Linear Branched**  
**Chandelier in**  
**Hand-Rubbed**  
**Antique Brass**  
O/A Height: 52"  
Min. Custom Height: 24"  
Width: 35"  
Canopy: 5.25" Round

**Finishes:**  
AN, BZ, HAB, PN  
**Shade Treatments:** NP

**Socket:**  
10 - Candelabra  
**Wattage:** 10 - 60 C

**Note:** CHS104NP  
Shades Sold Separately/  
Use 40 Watt Frosted Type  
"B" with Clip On Shades/  
Custom Height Available

**Designer:**  
E. F. Chapman

©EFC DESIGNS



**SL5863AN-NP2**



**S5316GI-NP**  
**Etoile Linear Pendant**  
**in Gilded Iron with**  
**Natural Paper Shades**  
O/A Height: 64"  
Fixture Height: 23.5"  
Width: 48"  
Canopy: 5.5" Round

**Finishes:** BR, GI  
**Shade Treatments:** NP  
**Shade Details:**  
4.5" x 5.5" x 6.5"

**Socket:**  
4 - Candelabra  
**Wattage:** 4 - 60 B

**Designer:**  
Ian Fowler



**S5316BR-NP**





**CHC1441AB**  
**Linear Flat Line**  
**Fixture in Antique-**  
**Burnished Brass**  
Height: 33"  
Width: 48"  
Canopy: 6" Square

**Finishes:**  
AB, AN, BZ, PN

**Socket:**  
5 - Candelabra  
**Wattage:** 5 - 60 C

**Designer:**  
E. F. Chapman

©EFC DESIGNS



**CHC1441BZ**



**SL5811PN-NP**  
**Classic Linear**  
**Chandelier in Polished**  
**Nickel with Natural**  
**Paper Shades**  
Height: 37.5"  
Width: 45.25"  
Canopy: 5.5" Round

**Finishes:**  
AN, BZ, HAB, PN  
**Shade Treatments:** NP  
**Shade Details:**  
3" x 6.5" x 5"

**Socket:**  
5 - Candelabra  
**Wattage:** 5 - 40 B

**Designer:**  
E. F. Chapman

©EFC DESIGNS



**SL5811BZ-NP**



**CHC1481PN-L**  
**Grosvenor Linear**  
**Double Pendant in**  
**Polished Nickel with**  
**Linen Shades**

O/A Height: 42.5"  
 Min. Custom Height: 28"  
 Width: 51"  
 Canopy: 6" Round

**Finishes:**

AB, AN, BZ, PN

**Shade Treatments: L**

**Shade Details:**  
 12" x 15" x 10.5"

**Socket: 4 - Keyless**

**Wattage: 4 - 75 A**

**Note:** Custom

Height Available

**Designer:**

E. F. Chapman

©EFC DESIGNS



**CHC1482AN-L**  
**Grosvenor Linear**  
**Triple Pendant in**  
**Antique Nickel with**  
**Linen Shades**

O/A Height: 42.5"  
 Min. Custom Height: 33"  
 Width: 74.5"  
 Canopy: 6" Round

**Finishes:**

AB, AN, BZ, PN

**Shade Treatments: L**

**Shade Details:**  
 12" x 15" x 10.5"

**Socket: 6 - Keyless**

**Wattage: 6 - 75 A**

**Note:** Custom

Height Available

**Designer:**

E. F. Chapman

©EFC DESIGNS



CHC1481BZ-L



CHC1482AB-L



LINEAR CEILING

VISUALCOMFORT.COM  
713.686.5999





**CHC5102AN-AN**  
**Sloane Double Shop**  
**Light in Antique**  
**Nickel with Antique**  
**Nickel Shades**  
O/A Height: 57"  
Min. Custom Height: 39"  
Width: 54"  
Canopy: 5.75" Round

**Finishes:** AB, AN, BZ  
**Shade Treatments:**  
AB, AN, BZ, L  
**Shade Details:**  
11.5" x 15.5" x 10"

**Socket:** 4 - Keyless  
**Wattage:** 4 - 60 A

**Note:** Custom  
Height Available

**Designer:**  
E.F. Chapman

©EFC DESIGNS



**CHC5102AB-L**



**LANTERNS CEILING**

CHC2165GI



**CHC2177PN**  
**Darlana Extra**  
**Large Lantern in**  
**Polished Nickel**  
Fixture Height: 42"  
Width: 29"  
Canopy: 7.5" Round

**Finishes:**  
Al, Gl, PN

**Socket:**  
6 - Candelabra  
**Wattage:** 6 - 60 C

**Designer:**  
E. F. Chapman

©EFC DESIGNS



CHC2177GI



CHC2177AI



**CHC2176PN**  
**Darlana Large Lantern**  
**in Polished Nickel**  
Height: 34"  
Width: 24"  
Canopy: 7.5" Round

**Finishes:** AI, GI, PN

**Socket:**  
6 - Candelabra  
**Wattage:** 6 - 60 C

**Designer:**  
E. F. Chapman

©EFC DESIGNS



CHC2176GI



CHC2176AI



**CHC2165PN**  
**Darlana Medium**  
**Lantern in**  
**Polished Nickel**  
 Height: 24.5"  
 Width: 17"  
 Canopy: 6" Round

CHC2165GI

**Finishes:**  
 AI, GI, OW, PN  
**Socket:**  
 4 - Candelabra  
**Wattage:** 4 - 60 C  
**Designer:**  
 E. F. Chapman  
 ©EFC DESIGNS



**CHC2164PN**  
**Darlana Small Lantern**  
**in Polished Nickel**  
 Height: 18"  
 Width: 12.5"  
 Canopy: 5.5" Round

CHC2164GI

CHC2164AI

**Finishes:** AI, GI, PN  
**Socket:**  
 4 - Candelabra  
**Wattage:** 4 - 60 C  
**Designer:**  
 E. F. Chapman  
 ©EFC DESIGNS



**CHC2175PN**  
**Darlana Mini Lantern**  
**in Polished Nickel**  
 Height: 14"  
 Width: 9.75"  
 Canopy: 5.5" Round

CHC2175GI

CHC2175AI

**Finishes:**  
 AI, GI, PN  
**Socket:**  
 3 - Candelabra  
**Wattage:** 3 - 60 C  
**Designer:**  
 E. F. Chapman  
 ©EFC DESIGNS





**CHC3440PN-CG**  
Plantation Large Lantern  
in Polished Nickel  
with Clear Glass  
Height: 42.75"  
Width: 28.75"  
Canopy: 7" Round

**Finishes:**  
AB, AN, BZ, PN  
**Glass Options:** CG

**Socket:**  
6 - Candelabra  
**Wattage:** 6 - 60 C

**Designer:**  
E. F. Chapman

©EFC DESIGNS



CHC3440AB-CG



CHC3440BZ-CG





**CHC3438PN-CG**  
**Plantation Small**  
**Lantern in Polished**  
**Nickel with**  
**Clear Glass**  
Height: 20"  
Width: 13.75"  
Canopy: 5.5" Round

**Finishes:**  
AB, AN, BZ, PN  
**Glass Options:** CG

**Socket:**  
4 - Candelabra  
**Wattage:** 4 - 60 C

**Designer:**  
E. F. Chapman

©EFC DESIGNS



**CHC3438BZ-CG**



**CHC3439PN-CG**  
**Plantation Medium**  
**Lantern in Polished**  
**Nickel with**  
**Clear Glass**  
Height: 31"  
Width: 21"  
Canopy: 5.5" Round

**Finishes:**  
AB, AN, BZ, PN  
**Glass Options:** CG

**Socket:**  
4 - Candelabra  
**Wattage:** 4 - 60 C

**Designer:**  
E. F. Chapman

©EFC DESIGNS



**CHC3439BZ-CG**



**CHC3441BZ**  
**Arch Top Large**  
**Tapered Lantern**  
**in Bronze**  
Height: 43.5"  
Width: 26"  
Canopy: 5.5" Round

**Finishes:**  
AB, AN, BZ, PN  
**Glass Options:** CG

**Socket:**  
5 - Candelabra  
**Wattage:** 5 - 60 C

**Designer:**  
E. F. Chapman

©EFC DESIGNS



**CHC3420PN**  
**Arch Top Mini Lantern**  
**in Polished Nickel**  
Height: 16.75"  
Width: 8.25"  
Canopy: 5.75" Round

**Finishes:**  
AB, AN, BZ, PN  
**Glass Options:** CG

**Socket:**  
3 - Candelabra  
**Wattage:** 3 - 60 C

**Designer:**  
E. F. Chapman

©EFC DESIGNS



**CHC3421BZ**  
**Arch Top Small**  
**Lantern in Bronze**  
Height: 24"  
Width: 14.5"  
Canopy: 5.75" Round

**Finishes:**  
AB, AN, BZ, PN  
**Glass Options:** CG

**Socket:**  
4 - Candelabra  
**Wattage:** 4 - 60 C

**Designer:**  
E. F. Chapman

©EFC DESIGNS



**CHC3422PN**  
**Arch Top**  
**Medium Lantern**  
**in Polished Nickel**  
Height: 29.5"  
Width: 17.5"  
Canopy: 5.75" Round

**Finishes:**  
AB, AN, BZ, PN  
**Glass Options:** CG

**Socket:**  
4 - Candelabra  
**Wattage:** 4 - 60 C

**Designer:**  
E. F. Chapman

©EFC DESIGNS



**CHC3425BZ**  
**Arch Top Large**  
**Lantern in Bronze**  
Height: 34.25"  
Width: 20.25"  
Canopy: 5.75" Round

**Finishes:**  
AB, AN, BZ, PN  
**Glass Options:** CG

**Socket:**  
5 - Candelabra  
**Wattage:** 5 - 60 C

**Designer:**  
E. F. Chapman

©EFC DESIGNS



**CHC3428PN**  
**Edwardian Arch Top**  
**Large Lantern in**  
**Polished Nickel**  
 Height: 34.5"  
 Width: 22"  
 Canopy: 5.75" Round

**Finishes:**  
 AB, AN, BZ, PN  
**Glass Options:** CG

**Socket:**  
 5 - Candelabra  
**Wattage:** 5 - 60 C

**Designer:**  
 E. F. Chapman

©EFC DESIGNS



**CHC3427AN**  
**Edwardian Arch Top**  
**Small Lantern in**  
**Antique Nickel**  
 Height: 25.5"  
 Width: 15"  
 Canopy: 5.75" Round

**Finishes:**  
 AB, AN, BZ, PN  
**Glass Options:** CG

**Socket:**  
 4 - Candelabra  
**Wattage:** 4 - 60 C

**Designer:**  
 E. F. Chapman

©EFC DESIGNS



**CHC3423AB**  
**Edwardian Arch Top**  
**Medium Lantern**  
**in Antique-**  
**Burnished Brass**  
 Height: 29.5"  
 Width: 18"  
 Canopy: 5.75" Round

**Finishes:**  
 AB, AN, BZ, PN  
**Glass Options:** CG

**Socket:**  
 5 - Candelabra  
**Wattage:** 5 - 60 C

**Designer:**  
 E. F. Chapman

©EFC DESIGNS



**CHC3426PN**  
**Edwardian Arch Top**  
**Mini Lantern in**  
**Polished Nickel**  
 Height: 17"  
 Width: 9"  
 Canopy: 5.75" Round

**Finishes:**  
 AB, AN, BZ, PN  
**Glass Options:** CG

**Socket:**  
 3 - Candelabra  
**Wattage:** 3 - 60 C

**Designer:**  
 E. F. Chapman

©EFC DESIGNS



CHC3426AB



CHC3426BZ



**CHC2251PN**  
**Lund Pendant in**  
**Polished Nickel**  
 Height: 7.75"  
 Width: 6.75"  
 Canopy: 5" Round

**Finishes:** AB, BZ, PN

**Socket:**  
 4 - Candelabra  
**Wattage:** 4 - 60 C

**Designer:**  
 E. F. Chapman

©EFC DESIGNS



CHC2251AB



CHC2251BZ



**SP5003BZ**  
**Greggory Large Lantern in Bronze**  
Height: 36.5"  
Width: 24"  
Canopy: 5.75" Round

**Finishes:**  
BZ, HAB, PN  
**Glass Options:** CG

**Socket:**  
4 - Candelabra  
**Wattage:** 4 - 60 C

**Designer:**  
J. Randall Powers



**SP5001HAB**  
**Greggory Small Lantern in Hand-Rubbed Antique Brass**  
Height: 19"  
Width: 12"  
Canopy: 5.75" Round

**Finishes:**  
BZ, HAB, PN  
**Glass Options:** CG

**Socket:**  
4 - Candelabra  
**Wattage:** 4 - 60 C

**Designer:**  
J. Randall Powers



**SP5002PN**  
**Greggory Medium Lantern in Polished Nickel**  
Height: 27.75"  
Width: 18"  
Canopy: 5.75" Round

**Finishes:**  
BZ, HAB, PN  
**Glass Options:** CG

**Socket:**  
4 - Candelabra  
**Wattage:** 4 - 60 C

**Designer:**  
J. Randall Powers





**CHC2182GI**  
**Darlana Large Fancy**  
**Lantern in Gilded Iron**  
 Height: 38"  
 Width: 22"  
 Canopy: 6.5" Round

**Finishes:** AI, GI, PN

**Socket:**  
 6 - Candelabra  
**Wattage:** 6 - 60 C

**Designer:**  
 E. F. Chapman

©EFC DESIGNS



**CHC2180PN**  
**Darlana Small**  
**Fancy Lantern in**  
**Polished Nickel**  
 Height: 22"  
 Width: 12.75"  
 Canopy: 5.5" Round

**Finishes:** AI, GI, PN

**Socket:**  
 4 - Candelabra  
**Wattage:** 4 - 60 C

**Designer:**  
 E. F. Chapman

©EFC DESIGNS



**CHC2181AI**  
**Darlana Medium Fancy**  
**Lantern in Aged Iron**  
 Height: 29.25"  
 Width: 17.25"  
 Canopy: 5.5" Round

**Finishes:** AI, GI, PN

**Socket:**  
 4 - Candelabra  
**Wattage:** 4 - 60 C

**Designer:**  
 E. F. Chapman

©EFC DESIGNS





**CHC2190GI**  
**Mykonos Mini Lantern**  
**in Gilded Iron**

Height: 13"  
Width: 8.75"  
Canopy: 5" Square

**Finishes:** AI, GI  
**Glass Options:** CG

**Socket:**  
4 - Candelabra  
**Wattage:** 4 - 40 C

**Designer:**  
E. F. Chapman

©EFC DESIGNS



CHC2190AI



**CHC2161GI**  
**Mykonos Medium**  
**Lantern in Gilded Iron**

Height: 25.25"  
Width: 17.25"  
Canopy: 6.5" Octagon

**Finishes:** AI, GI  
**Glass Options:** CG

**Socket:**  
4 - Candelabra  
**Wattage:** 4 - 60 C

**Designer:**  
E. F. Chapman

©EFC DESIGNS



CHC2161AI



**CHC2108AB**  
**Scroll Small**  
**Pendant in Antique-**  
**Burnished Brass**  
Height: 15.5"  
Width: 8"  
Canopy: 5.5" Round

**Finishes:** AB, BR

**Socket:**  
3 - Candelabra  
**Wattage:** 3 - 60 C

**Designer:**  
E. F. Chapman

©EFC DESIGNS

CHC2108BR



**CHC2107AB**  
**Scroll Large**  
**Pendant in Antique-**  
**Burnished Brass**  
Height: 27.25"  
Width: 16"  
Canopy: 5.5" Round

**Finishes:** AB, BR

**Socket:**  
4 - Candelabra  
**Wattage:** 4 - 60 C

**Designer:**  
E. F. Chapman

©EFC DESIGNS

CHC2107BR



**CHC3109GI**  
**Diego Petite Classical**  
**Perching Bird Lantern**  
**in Gilded Iron**  
Height: 14"  
Width: 8"  
Canopy: 5" Round

**Finishes:** GI, R  
**Glass Options:** CG

**Socket:**  
3 - Candelabra  
**Wattage:** 3 - 60 C

**Designer:**  
E. F. Chapman

©EFC DESIGNS



CHC3109R



**CHC3108GI**  
**Diego Grande Classical**  
**Perching Bird Lantern**  
**in Gilded Iron**  
Height: 25"  
Width: 16"  
Canopy: 5" Round

**Finishes:** GI, R

**Socket:**  
4 - Candelabra  
**Wattage:** 4 - 60 C

**Designer:**  
E. F. Chapman

©EFC DESIGNS



CHC3108R



**CHC3413GI**  
**French Market Small Lantern in Gilded Iron**  
 Height: 16.75"  
 Width: 9.5"  
 Canopy: 5.75" Round

**Finishes:** BR, GI  
**Glass Options:** CG

**Socket:**  
 3 - Candelabra  
**Wattage:** 3 - 60 C

**Designer:**  
 E. F. Chapman

©EFC DESIGNS



**CHC3414BR**  
**French Market Medium Lantern in Black Rust**  
 Height: 30.5"  
 Width: 16.5"  
 Canopy: 5.5" Round

**Finishes:** BR, GI  
**Glass Options:** CG

**Socket:**  
 3 - Candelabra  
**Wattage:** 3 - 60 C

**Designer:**  
 E. F. Chapman

©EFC DESIGNS



**CHC3436AB**  
**Westminster Medium Lantern in Antique-Burnished Brass**  
 Height: 34.75"  
 Width: 20"  
 Canopy: 6.5" Round

**Finishes:**  
 AB, BZ, PN  
**Glass Options:** CG

**Socket:** 6 - Candelabra  
**Wattage:** 6 - 60 C

**Designer:**  
 E. F. Chapman

©EFC DESIGNS



**CHC3436BZ**



**SR5005GI**  
**Baltic Lantern in**  
**Gilded Iron**  
Height: 23"  
Width: 12.5"  
Canopy: 5" Round

**Finishes:** AI, GI

**Socket:**  
3 - Candelabra  
**Wattage:** 3 - 60 C

**Designer:**  
John Rosselli



SR5005AI



**CHC2155GI**  
**Clover Square Lantern**  
**in Gilded Iron**  
Height: 39.25"  
Width: 16.5"  
Canopy: 5.5" Round

**Finishes:** AI, GI  
**Glass Options:** CG

**Socket:**  
6 - Candelabra  
**Wattage:** 6 - 60 C

**Designer:**  
E. F. Chapman

©EFC DESIGNS



CHC2155AI



**SK5513BG**  
**Nina Wooden Lantern**  
**in Belgian Gild**  
Height: 36.25"  
Width: 18.5"  
Canopy: 5" Round

**Finishes:** BG

**Socket:**  
3 - Candelabra  
**Wattage:** 3 - 60 C

**Designer:**  
Suzanne Kasler



**CHC2366GI**  
**Darlana Large**  
**Round Lantern in**  
**Gilded Iron**  
Height: 35.5"  
Width: 24.5"  
Canopy: 6" Round

**Finishes:**  
AI, GI, PN

**Socket:**  
6 - Candelabra  
**Wattage:** 6 - 60 C

**Designer:**  
E. F. Chapman

©EFC DESIGNS



CHC2366AI



**CHC2160G**  
**Desmond Cage**  
**Lantern in Gild**  
Height: 36"  
Width: 21"  
Canopy: 5.5" Round

**Finishes:** AI, G

**Socket:**  
4 - Candelabra  
**Wattage:** 4 - 60 C

**Designer:**  
E. F. Chapman

©EFC DESIGNS



CHC2160AI



**CHC2217PN**  
**Osborne Lantern**  
**in Polished Nickel**  
Height: 22"  
Width: 18"  
Canopy: 5.5" Square

**Finishes:** AI, GI, PN

**Socket:**  
3 - Candelabra  
**Wattage:** 3 - 60 C

**Designer:**  
E. F. Chapman

©EFC DESIGNS



CHC2217GI



CHC2217AI





**SP5004AI**  
**Star Lantern**  
**in Aged Iron**  
Height: 29"  
Width: 18"  
Canopy: 5.75"  
Round

**Finishes:** AI

**Socket:**  
4 - Candelabra  
**Wattage:** 4 - 60 C

**Designer:**  
J. Randall Powers





**SL5872BR**  
**Cornice Large**  
**Hanging Lantern in**  
**Blackened Rust**  
O/A Height: 41"  
Fixture Height: 36"  
Width: 20"  
Canopy: 6" Round

**Finishes:**  
BR, BZ, HAB, PN  
**Glass Options:** CG

**Socket:**  
4 - Candelabra  
**Wattage:** 4 - 60 C

**Designer:**  
E. F. Chapman

©EFC DESIGNS



**SL5870HAB**  
**Cornice Semi-Flush**  
**Lantern in Hand-**  
**Rubbed Antique Brass**  
Height: 16.5"  
Width: 9.5"  
Canopy: 6" Round

**Finishes:**  
BR, BZ, HAB, PN  
**Glass Options:** CG

**Socket:**  
3 - Candelabra  
**Wattage:** 3 - 60 C

**Designer:**  
E. F. Chapman

©EFC DESIGNS



**SL5871PN**  
**Cornice Small**  
**Hanging Lantern in**  
**Polished Nickel**  
Height: 24"  
Min. Custom Height: 31"  
Width: 14.5"  
Canopy: 6" Round

**Finishes:**  
BR, BZ, HAB, PN  
**Glass Options:** CG

**Socket:**  
4 - Candelabra  
**Wattage:** 4 - 60 C

**Designer:**  
E. F. Chapman

©EFC DESIGNS



**CHC2215AI**  
**Holborn Small Lantern**  
in Aged Iron  
Height: 34.5"  
Width: 14"  
Canopy: 5.5" Round

**Finishes:** AI, OW  
**Glass Options:** CG

**Socket:**  
4 - Candelabra  
**Wattage:** 4 - 60 C

**Designer:**  
E. F. Chapman

©EFC DESIGNS



CHC2215OW



**CHC2216AI**  
**Holborn Large Lantern**  
in Aged Iron  
Height: 45"  
Width: 18.25"  
Canopy: 5.5" Round

**Finishes:** AI, OW  
**Glass Options:** CG

**Socket:**  
4 - Candelabra  
**Wattage:** 4 - 60 C

**Designer:**  
E. F. Chapman

©EFC DESIGNS



CHC2216OW





**CHC5050WZ**  
**Elsinore Hanging Lantern**  
in Weathered Zinc  
Height: 21.25"  
Width: 14.5"  
Canopy: 6" Round

**Finishes:** BLK, WZ  
**Glass Options:** CG

**Socket:**  
4 - Candelabra  
**Wattage:** 4 - 60 C

**Designer:**  
E. F. Chapman

©EFC DESIGNS



**SK5007VG**  
**Brantley Lantern**  
in Verdigris  
Height: 21.5"  
Width: 12"  
Canopy: 5.5" Round

**Finishes:** VG  
**Glass Options:** CG

**Socket:**  
2 - Candelabra  
**Wattage:** 2 - 60 C

**Designer:**  
Suzanne Kasler



**SK5300AZ**  
**Honore Small Lantern**  
in Antique Zinc  
Height: 21"  
Width: 12"  
Canopy: 4.75" Round

**Finishes:** AZ  
**Glass Options:** CG

**Socket:**  
3 - Candelabra  
**Wattage:** 3 - 60 C

**Designer:**  
Suzanne Kasler



**SK5301AZ**  
**Honore Lantern**  
in Antique Zinc  
Height: 27"  
Width: 16"  
Canopy: 4.75" Round

**Finishes:** AZ  
**Glass Options:** CG

**Socket:**  
3 - Candelabra  
**Wattage:** 3 - 60 C

**Designer:**  
Suzanne Kasler



**CHC5213BSL-AM**  
**Moravian XL Star in**  
**Burnished Silver Leaf**  
**with Antique Mirror**  
Height: 52.25"  
Width: 48"  
Canopy: 6" Round

**Finishes:**  
Al, BSL, GI  
**Glass Options:** AM

**Socket:** 3 - Keyless  
**Wattage:** 3 - 60 A

**Designer:**  
E. F. Chapman

©EFC DESIGNS



**CHC5213GI-AM**



**CHC5213AI-AM**





**CHC5211GI-AM**  
**Moravian Medium Star**  
**in Gilded Iron**  
**with Antique Mirror**  
Height: 19.75"  
Width: 18"  
Canopy: 6" Round

**Finishes:**  
AI, BSL, GI  
**Glass Options:** AM

**Socket:** Keyless  
**Wattage:** 75 A

**Designer:**  
E. F. Chapman

©EFC DESIGNS

**CHC5213GI-AM**  
**Moravian XL Star**  
**in Gilded Iron**  
**with Antique Mirror**

**CHC5212GI-AM**  
**Moravian Large Star**  
**in Gilded Iron**  
**with Antique Mirror**  
Height: 32.75"  
Width: 30"  
Canopy: 6" Round

**Finishes:** AI, BSL, GI  
**Glass Options:** AM

**Socket:** Keyless  
**Wattage:** 100 A

**Designer:**  
E. F. Chapman

©EFC DESIGNS

**CHC5201GI-AM**  
**Zeno Medium 18**  
**Facet Hedron Lantern**  
**in Gilded Iron**  
**with Antique Mirror**  
Height: 20"  
Width: 16"  
Canopy: 5.5" Hexagon

**Finishes:** AI, BSL, GI  
**Glass Options:** AM

**Socket:**  
4 - Candelabra  
**Wattage:** 4 - 60 C

**Designer:**  
E. F. Chapman

©EFC DESIGNS



CHC5201AI-AM



**CHC5203GI-AM**  
**Zeno Medium 80**  
**Facet Hedron Lantern**  
**in Gilded Iron**  
**with Antique Mirror**  
Height: 20.25"  
Width: 18"  
Canopy: 5.5" Hexagon

**Finishes:** AI, BSL, GI  
**Glass Options:** AM

**Socket:** Keyless  
**Wattage:** 75 A

**Designer:**  
E. F. Chapman

©EFC DESIGNS



CHC5203AI-AM



**CHC5234GI-AM**  
**Girard Medium Inverse**  
**Tapered Hex Lantern**  
**in Gilded Iron**  
**with Antique Mirror**  
Height: 26.5"  
Width: 16"  
Canopy: 5.5" Hexagon

**Finishes:** AI, BSL, GI  
**Glass Options:** AM

**Socket:** Keyless  
**Wattage:** 100 A

**Designer:**  
E. F. Chapman

©EFC DESIGNS



**CHC5235AI-AM**  
**Girard Large Inverse**  
**Tapered Hex Lantern in**  
**Aged Iron**  
**with Antique Mirror**  
Height: 33"  
Width: 19.75"  
Canopy: 5.5" Hexagon

**Finishes:** AI, BSL, GI  
**Glass Options:** AM

**Socket:** Keyless  
**Wattage:** 100 A

**Designer:**  
E. F. Chapman

©EFC DESIGNS



**CHC5231GI-AM**  
**Girard Medium**  
**Tapered Hex Lantern**  
**in Gilded Iron with**  
**Antique Mirror**  
Height: 26.5"  
Width: 16"  
Canopy: 5.5" Hexagon

**Finishes:** AI, BSL, GI  
**Glass Options:** AM

**Socket:** Keyless  
**Wattage:** 100 A

**Designer:**  
E. F. Chapman

©EFC DESIGNS



**CHC5232AI-AM**  
**Girard Large Tapered**  
**Hex Lantern in**  
**Aged Iron with**  
**Antique Mirror**  
Height: 33"  
Width: 19.75"  
Canopy: 5.5" Hexagon

**Finishes:** AI, BSL, GI  
**Glass Options:** AM

**Socket:** Keyless  
**Wattage:** 100 A

**Designer:**  
E. F. Chapman

©EFC DESIGNS





**SK5010PN-CG**  
**Morris Large Lantern**  
in Polished Nickel  
with Clear Glass  
Height: 30.25"  
Width: 23.25"  
Canopy: 4.75" Round

**Finishes:** AZ, GI, PN  
**Glass Options:** CG, FG

**Socket:** 3 - Candelabra  
**Wattage:** 3 - 60 C

**Designer:**  
Suzanne Kasler



**SK5008PN-CG**  
**Morris Small Lantern**  
in Polished Nickel  
with Clear Glass  
Height: 21.5"  
Width: 13.5"  
Canopy: 4.75" Round

**Finishes:** AZ, GI, PN  
**Glass Options:** CG, FG

**Socket:** 3 - Candelabra  
**Wattage:** 3 - 60 C

**Designer:**  
Suzanne Kasler



**SK5009PN-FG**  
**Morris Medium**  
Lantern in Polished  
Nickel with  
Frosted Glass  
Height: 26"  
Width: 18.5"  
Canopy: 4.75" Round

**Finishes:** AZ, GI, PN  
**Glass Options:** CG, FG

**Socket:** 3 - Candelabra  
**Wattage:** 3 - 60 C

**Designer:**  
Suzanne Kasler



**SK5010GI-CG**  
**Morris Large Lantern**  
 in Gilded Iron  
 with Clear Glass  
 Height: 30.25"  
 Width: 23.25"  
 Canopy: 4.75" Round

**Finishes:** AZ, GI, PN  
**Glass Options:** CG, FG

**Socket:**  
 3 - Candelabra  
**Wattage:** 3 - 60 C

**Designer:**  
 Suzanne Kasler



**SK5008GI-CG**  
**Morris Small Lantern**  
 in Gilded Iron with  
 Clear Glass  
 Height: 21.5"  
 Width: 13.5"  
 Canopy: 4.75" Round

**Finishes:** AZ, GI, PN  
**Glass Options:** CG, FG

**Socket:**  
 3 - Candelabra  
**Wattage:** 3 - 60 C

**Designer:**  
 Suzanne Kasler



**SK5009GI-FG**  
**Morris Medium**  
 Lantern in Gilded Iron  
 with Frosted Glass  
 Height: 26"  
 Width: 18.5"  
 Canopy: 4.75" Round

**Finishes:** AZ, GI, PN  
**Glass Options:** CG, FG

**Socket:**  
 3 - Candelabra  
**Wattage:** 3 - 60 C

**Designer:**  
 Suzanne Kasler



**SK5010AZ-CG**  
**Morris Large Lantern**  
in Antique Zinc  
with Clear Glass  
Height: 30.25"  
Width: 23.25"  
Canopy: 4.75" Round

**Finishes:** AZ, GI, PN  
**Glass Options:** CG, FG

**Socket:**  
3 - Candelabra  
**Wattage:** 3 - 60 C

**Designer:**  
Suzanne Kasler



**SK5008AZ-CG**  
**Morris Small Lantern**  
in Antique Zinc with  
Clear Glass  
Height: 21.5"  
Width: 13.5"  
Canopy: 4.75" Round

**Finishes:** AZ, GI, PN  
**Glass Options:** CG, FG

**Socket:**  
3 - Candelabra  
**Wattage:** 3 - 60 C

**Designer:**  
Suzanne Kasler



**SK5009AZ-FG**  
**Morris Medium**  
Lantern in Antique  
Zinc with  
Frosted Glass  
Height: 26"  
Width: 18.5"  
Canopy: 4.75" Round

**Finishes:** AZ, GI, PN  
**Glass Options:** CG, FG

**Socket:**  
3 - Candelabra  
**Wattage:** 3 - 60 C

**Designer:**  
Suzanne Kasler



**NW5100BSL**  
**Chatsworth Lantern in**  
**Burnished Silver Leaf**  
Fixture Height: 25"  
Width: 16"  
Canopy: 6" Round  
  
**Finishes:** AI, BSL, GI  
  
**Socket:** 6 - Candelabra  
**Wattage:** 6 - 60 C  
  
**Designer:**  
Niermann Weeks



NW5100GI



NW5100AI





**CHC2535GI**  
**Marquise Wide Lantern**  
**in Gilded Iron**  
Fixture Height: 26.75"  
Width: 23.25"  
Canopy: 5.5" Round

**Finishes:** AI, BSL, GI

**Socket:** 6 - Candelabra  
**Wattage:** 6 - 60 B

**Designer:**  
E. F. Chapman

©EFC DESIGNS

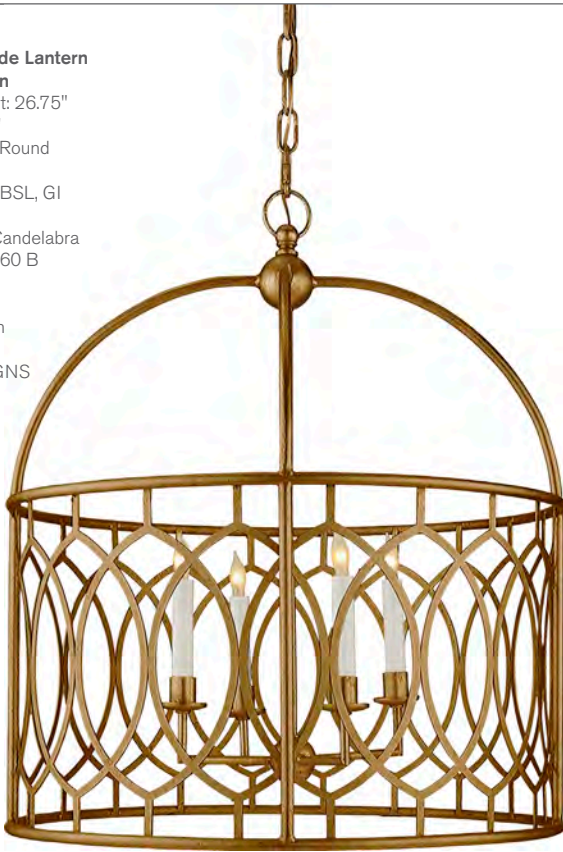

**CHC2536BSL**  
**Marquise Tall**  
**Lantern in Burnished**  
**Silver Leaf**  
Fixture Height: 38.75"  
Width: 21"  
Canopy: 5.5" Round

**Finishes:** AI, BSL, GI

**Socket:** 6 - Candelabra  
**Wattage:** 6 - 60 B

**Designer:**  
E. F. Chapman

©EFC DESIGNS



**CHC2535AI**



**CHC2186GI**  
**Gramercy Medium**  
**Lantern in Gilded Iron**  
Height: 29"  
Width: 17"  
Canopy: 6" Round

**Finishes:** AI, GI

**Socket:**  
4 - Candelabra  
**Wattage:** 4 - 60 C

**Designer:**  
E. F. Chapman

©EFC DESIGNS



CHC2186AI



**CHC3444GI**  
**Brighton Pagoda**  
**Lantern in Gilded Iron**  
Fixture Height: 28.25"  
Width: 20.25"  
Canopy: 6" Round

**Finishes:**  
AI, BSL, GI

**Socket:**  
4 - Candelabra  
**Wattage:** 4 - 60 C

**Designer:**  
E. F. Chapman

©EFC DESIGNS



CHC3444AI





**CHC2169BSL-NP**  
**Victoria Small Pendant**  
**in Burnished Silver**  
**Leaf with Natural**  
**Paper Shade**  
Height: 24.25"  
Width: 14"  
Canopy: 5.75" Round

**Finishes:**  
BSL, GI, OW  
**Shade Treatments:** NP  
**Shade Details:**  
6.5" x 6.5" x 9" Square

**Socket:** Keyless  
**Wattage:** 75 A

**Designer:**  
E. F. Chapman

©EFC DESIGNS



**CHC1477GI**  
**Copene Medium**  
**Round Lantern in**  
**Gilded Iron**  
Height: 35"  
Width: 18"  
Canopy: 5.75" Round

**Finishes:** AI, GI

**Socket:**  
4 - Candelabra  
**Wattage:** 4 - 40 C

**Designer:**  
E. F. Chapman



CHC1477AI



**ARN5210BSL-L**  
**Edgerly Hanging**  
**Shade in Burnished**  
**Silver Leaf with**  
**Linen Shades**  
Height: 23.5"  
Width: 23"  
Canopy: 8" Round

**Finishes:** BSL, G  
**Shade Treatments:** L  
**Shade Details:**  
4" x 5" x 6" Nordy

**Socket:**  
4 - Candelabra  
**Wattage:** 4 - 40 B

**Designer:**  
AERIN



ARN5210G-L



**S5045BSL-L**  
**Bracelet Small**  
**Pendant in Burnished**  
**Silver Leaf with**  
**Linen Shade**  
 Height: 12"  
 Width: 8"  
 Canopy: 6" Round

**Finishes:**  
 AI, BSL, GI  
**Shade Treatments:** L  
**Shade Details:**  
 6" x 6" x 11"

**Socket:** Keyless  
**Wattage:** 60 B

**Designer:**  
 Barry Goralnick



S5045AI-L



**S5046BSL-L**  
**Bracelet Large**  
**Pendant in Burnished**  
**Silver Leaf with**  
**Linen Shade**  
 Height: 24"  
 Width: 16"  
 Canopy: 6" Round

**Finishes:**  
 AI, BSL, GI  
**Shade Treatments:** L  
**Shade Details:**  
 12.5" x 12.5" x 21"

**Socket:** Keyless  
**Wattage:** 75 A

**Designer:**  
 Barry Goralnick



S5046AI-L



S5045GI-L



**BBL5058BZ-S**  
**Capitol Narrow**  
**Lantern in Bronze**  
**with Silk Shade**  
Height: 29.75"  
Width: 17.5"  
Canopy: 6.5" Round

**Finishes:**  
BZ, SB, SS  
**Shade Treatments:** S  
**Shade Details:**  
14.5" x 14.5" x 20"

**Socket:** 4 - Candelabra  
**Wattage:** 4 - 60 C

**Designer:**  
Barbara Barry



BBL5058SB-S



**BBL5055BZ-S**  
**Capitol Wide Lantern**  
**in Bronze with**  
**Silk Shade**  
Height: 24.5"  
Width: 23.5"  
Canopy: 6.5" Round

**Finishes:**  
BZ, SB, SS  
**Shade Treatments:** S  
**Shade Details:**  
19.5" x 19.5" x 12"

**Socket:**  
4 - Candelabra  
**Wattage:** 4 - 60 C

**Designer:**  
Barbara Barry



BBL5055SB-S





**TOB5105PN-NP**  
**Bryant Large Lantern**  
in Polished Nickel  
with Natural  
Paper Shade  
O/A Height: 48.5"  
Fixture Height: 26"  
Min. Custom Height: 35"  
Width: 21.5"  
Canopy: 7" Round

**Finishes:**  
AN, BZ, HAB, PN  
**Shade Treatments:** NP  
**Shade Details:**  
16" x 16" x 19"

**Socket:**  
4 - Candelabra  
**Wattage:** 4 - 60 B

**Note:** Custom  
Height Available

**Designer:**  
Thomas O'Brien



**TOB5105BZ-NP**



**CHC2167PN-NP**  
**Gustavian Lantern** in  
Polished Nickel with  
Natural Paper Shade  
Height: 35.75"  
Width: 20"  
Canopy: 5" Round

**Finishes:** AI, GI, PN  
**Shade Treatments:** NP  
**Shade Details:**  
16" x 16" x 17"

**Socket:** 3 - Keyless  
**Wattage:** 3 - 40 A

**Designer:**  
E. F. Chapman

©EFC DESIGNS



**CHC2167GI**





**NW5025BSL**  
**Sophie Large**  
**Lantern in Burnished**  
**Silver Leaf**  
Height: 30.5"  
Width: 18"  
Canopy: 5" Round

**Finishes:** BSL, G

**Socket:**  
4 - Candelabra  
**Wattage:** 4 - 60 C

**Designer:**  
Niermann Weeks



**NW5025GI**



**NW5026BSL**  
**Sophie Large**  
**Pendant in Burnished**  
**Silver Leaf**  
Height: 30.5"  
Width: 29.75"  
Canopy: 5" Round

**Finishes:** BSL, G

**Socket:**  
8 - Candelabra  
**Wattage:** 8 - 60 C

**Designer:**  
Niermann Weeks

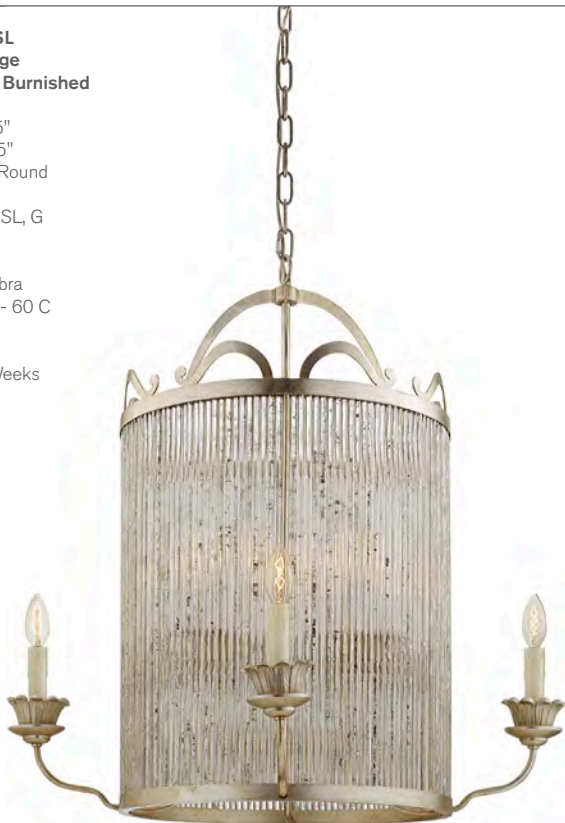

**NW5026GI**



**SC5160BZ**  
**Caged Medium**  
**Lantern in Bronze with**  
**Natural Paper Shade**  
Height: 22"  
Width: 22"  
Canopy: 7" Round

**Finishes:**  
BZ, HAB, PN  
**Shade Treatments:** NP  
**Shade Details:**  
15.25" Cube

**Socket:** 2 - Keyless  
**Wattage:** 2 - 60 A

**Designer:**  
Eric Cohler



**SC5159HAB**  
Caged Small Lantern  
in Hand-Rubbed  
Antique Brass with  
Natural Paper Shade  
Height: 16"  
Width: 16"  
Canopy: 7" Round

**Finishes:**  
BZ, HAB, PN  
**Shade Treatments:** NP  
**Shade Details:**  
11" Cube

**Socket:** Keyless  
**Wattage:** 60 B

**Designer:**  
Eric Cohler



**SC5159BZ**



**SC5160PN**  
Caged Medium  
Lantern in Polished  
Nickel with Natural  
Paper Shade  
Height: 22"  
Width: 22"  
Canopy: 7" Round

**Finishes:**  
BZ, HAB, PN  
**Shade Treatments:** NP  
**Shade Details:**  
15.25" Cube  
**Socket:** 2 - Keyless  
**Wattage:** 2 - 60 A

**Designer:**  
Eric Cohler



**SC5160HAB**



**CHC2530GI**  
**Metal Banded Pendant**  
**in Gilded Iron**  
**with Frosted Glass**  
O/A Height: 65.25"  
Fixture Height: 23.5"  
Width: 20.75"  
Canopy: 5.5" Hexagon

**Finishes:** AI, GI  
**Glass Options:** FG

**Socket:** Keyless  
**Wattage:** 75 A

**Note:** Custom  
Height Available

**Designer:**  
E. F. Chapman

©EFC DESIGNS

CHC2530AI



**CHC2531GI**  
**Metal Banded Large**  
**Pendant in Gilded Iron**  
**with Frosted Glass**  
O/A Height: 84.25"  
Fixture Height: 31"  
Width: 29.5"  
Canopy: 5.5" Hexagon

**Finishes:** AI, GI  
**Glass Options:** FG

**Socket:** Keyless  
**Wattage:** 100 A

**Note:** Custom  
Height Available

**Designer:**  
E. F. Chapman

©EFC DESIGNS

CHC2531AI



CHC2531GI







**ARN5002BSL**  
**Mill Ceiling Light in**  
**Burnished Silver Leaf**  
Height: 32.25"  
Width: 30"  
Canopy: 6" Round

**Finishes:**  
AI, BSL, G, PW

**Socket:**  
6 - Candelabra  
**Wattage:** 6 - 60 C

**Designer:**  
AERIN

ARN5002AI



**ARN5003BSL**  
**Mill Small Ceiling**  
**Light in Burnished**  
**Silver Leaf**  
Height: 18.5"  
Width: 16"  
Canopy: 6" Round

**Finishes:**  
AI, BSL, G, PW

**Socket:**  
4 - Candelabra  
**Wattage:** 4 - 60 C

**Designer:**  
AERIN

ARN5003G

ARN5003AI



**CHC2135PN-WG**  
**Modern Globe Pendant**  
**in Polished Nickel**  
**with White Glass**  
 Height: 39.25"  
 Width: 24.25"  
 Canopy: 5.5" Round

**Finishes:**  
 AB, BZ, PN  
**Glass Options:** WG

**Socket:** 2 - Keyless  
**Wattage:** 2 - 75 A

**Designer:**  
 E. F. Chapman

©EFC DESIGNS



CHC2135AB-WG



**CHC2136PN-WG**  
**Modern Large**  
**Globe Pendant in**  
**Polished Nickel**  
**with White Glass**  
 O/A Height: 54"  
 Fixture Height: 21.75"  
 Width: 32"  
 Canopy: 6" Round

**Finishes:**  
 AB, BZ, PN  
**Glass Options:** WG

**Socket:** 3 - Keyless  
**Wattage:** 3 - 75 A

**Designer:**  
 E. F. Chapman

©EFC DESIGNS



CHC2136BZ-WG



**CHC2112AB-WG**  
**Zodiac Pendant in**  
**Antique-Burnished**  
**Brass with White Glass**  
O/A Height: 46.5"  
Fixture Height: 27"  
Width: 23.5"  
Canopy: 6" Round

**Finishes:** AB, BZV  
**Glass Options:** WG

**Socket:** 2 - Keyless  
**Wattage:** 2 - 100 A

**Designer:**  
E. F. Chapman

©EFC DESIGNS



**CHC2128PN-CG**  
**Alderly Globe Pend**  
**in Polished Nickel**  
**with Clear Glass**  
 Height: 21.25"  
 Width: 15.5"  
 Canopy: 5.5" Round

**Finishes:** AB, PN  
**Glass Options:** CG

**Socket:**  
 3 - Candelabra  
**Wattage:** 3 - 60 C

**Designer:**  
 E. F. Chapman

©EFC DESIGNS



CHC2128AB-CG



**CHC2111AB-CG**  
**Crown Top Banded**  
**Globe in Antique-**  
**Burnished Brass**  
**with Clear Glass**  
 Height: 21"  
 Width: 15"  
 Canopy: 5.5" Round

**Finishes:**  
 AB, AW, BR, BZ/AB  
**Glass Options:**  
 CG, WG

**Socket:**  
 3 - Candelabra  
**Wattage:** 3 - 60 C

**Designer:**  
 E. F. Chapman

©EFC DESIGNS



CHC2111AW-CG



CHC2111BZ/AB-CG



**MS5030ABV-WG**  
**Modern Schoolhouse**  
**Pendant in Antique**  
**Brass Verdigris**  
**with White Glass**  
Height: 29"  
Width: 20"  
Canopy: 7.5" Round

**Finishes:** ABV  
**Glass Options:** WG

**Socket:** 2 - Keyless  
**Wattage:** 2 - 75 A

**Note:** Custom  
Height Available

**Designer:**  
Michael S Smith



**SK5540AI**  
**Elise Medium Lantern**  
in Aged Iron  
Height: 26"  
Width: 20.75"  
Canopy: 6" Round

**Finishes:** AI

**Socket:**  
4 - Candelabra  
**Wattage:** 4 - 60 C

**Designer:**  
Suzanne Kasler



**CHC2270AI-MG**  
**Lorford Smoke Bell**  
**Lantern in Aged Iron**  
**with Mercury Glass**  
Fixture Height: 33.75"  
Width: 20"  
Canopy: 5.5" Round

**Finishes:** AI, GI  
**Glass Options:** MG

**Socket:**  
4 - Candelabra  
**Wattage:** 4 - 60 C

**Designer:**  
E. F. Chapman

©EFC DESIGNS

**CHC2270GI-MG**



**SR5101AI**  
**Callie Hanging**  
**Pendant in**  
**Aged Iron**  
Height: 35.25"  
Width: 11.5"  
Canopy: 5.5" Round

**Finishes:**  
AI, BSL, GI

**Socket:**  
3 - Candelabra  
**Wattage:** 3 - 60 C

**Note:** Custom  
Height Available

**Designer:**  
John Rosselli



SR5101BSL



SR5101GI



**SR5002BSL**  
**Maher Pendant in**  
**Burnished Silver Leaf**  
Height: 24.5"  
Width: 12.5"  
Canopy: 5" Round

**Finishes:** BSL, GI

**Socket:**  
4 - Candelabra  
**Wattage:** 4 - 60 C

**Designer:**  
John Rosselli



SR5002GI





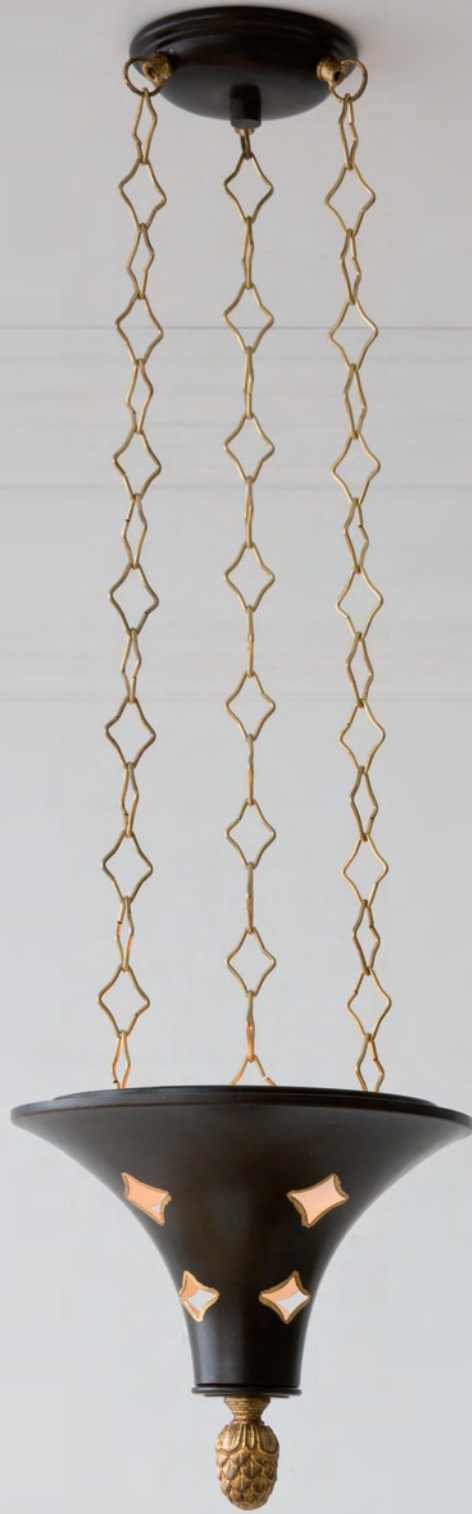

**ARN5200BSL**  
**Pondview Ceiling**  
**Light in Burnished**  
**Silver Leaf**  
Height: 37.5"  
Width: 19.5"  
Canopy: 6.25" Round

**Finishes:** BSL, HAB  
**Glass Options:** CG

**Socket:**  
3 - Candelabra  
**Wattage:** 3 - 60 C

**Designer:**  
AERIN

ARN5200HAB



**CHC2209PN**  
**Sussex Semi-Flush**  
**Bell Jar Lantern**  
**in Polished Nickel**  
Height: 18"  
Width: 12"  
Canopy: 6" Round

**Finishes:**  
AB, AN, BZ, PN  
**Glass Options:** CG

**Socket:**  
4 - Candelabra  
**Wattage:** 4 - 60 C

**Designer:**  
E. F. Chapman

©EFC DESIGNS



CHC2209AN



**CHC2210AB**  
**Sussex Medium Bell**  
**Jar Lantern in Antique-**  
**Burnished Brass**  
Height: 36"  
Width: 19"  
Canopy: 5" Round

**Finishes:**  
AB, AN, BZ, PN  
**Glass Options:** CG

**Socket:**  
4 - Candelabra  
**Wattage:** 4 - 60 C

**Designer:**  
E. F. Chapman

©EFC DESIGNS



CHC2210BZ



**CHC2110PN**  
**Country Large Bell Jar Lantern in Polished Nickel**  
 Height: 25.75"  
 Width: 21"  
 Canopy: 6" Round

**Finishes:**  
 AB, AN, BZ, PN  
**Glass Options:** CG

**Socket:**  
 6 - Candelabra  
**Wattage:** 6 - 60 C

**Designer:**  
 E. F. Chapman  
 ©EFC DESIGNS

CHC2110AB



**CHC2212GI**  
**New Country Large Bell Jar Lantern in Gilded Iron**  
 Height: 32.75"  
 Width: 23"  
 Canopy: 6" Round

**Finishes:** AI, GI, OW  
**Glass Options:** CG  
**Socket:** 6 - Candelabra

**Wattage:** 6 - 60 C  
**Designer:**  
 E. F. Chapman  
 ©EFC DESIGNS

CHC2212AI



**CHC2109PN**  
**Country Semi-Flush**  
**Bell Jar Lantern**  
**in Polished Nickel**  
 Height: 16.5"  
 Width: 13"  
 Canopy: 6" Round

**Finishes:**  
 AB, AN, BZ, PN  
**Glass Options:** CG

**Socket:**  
 3 - Candelabra  
**Wattage:** 3 - 60 C

**Designer:**  
 E. F. Chapman

©EFC DESIGNS



CHC2109A



**CHC2117PN**  
**Country Medium**  
**Bell Jar Lantern**  
**in Polished Nickel**  
 Height: 21"  
 Width: 15.5"  
 Canopy: 6" Round

**Finishes:**  
 AB, AN, BZ, PN  
**Glass Options:** CG

**Socket:** 6 - Candelabra  
**Wattage:** 6 - 60 C

**Designer:**  
 E. F. Chapman

©EFC DESIGNS

CHC2117AB



CHC2117BZ



**CHC2126PN**  
**Georgian Large**  
**Smoke Bell Lantern**  
**in Polished Nickel**  
Height: 47"  
Width: 19"  
Canopy: 5.5" Round

**Finishes:**  
AB, AN, BZ, PN  
**Glass Options:** CG

**Socket:**  
5 - Candelabra  
**Wattage:** 5 - 60 C

**Designer:**  
E. F. Chapman

©EFC DESIGNS

CHC2126AB



**CHC2118PN**  
Chelsea Semi-Flush  
Smoke Bell Jar  
Lantern in  
Polished Nickel  
Height: 18"  
Width: 10"  
Canopy: 6" Round

**Finishes:**  
AB, AN, BZ, PN  
**Glass Options:** CG

**Socket:**  
3 - Candelabra  
**Wattage:** 3 - 60 C

**Designer:**  
E. F. Chapman

©EFC DESIGNS



CHC2118AN



CHC2118AB



CHC2118BZ



**TOB5030HAB**  
**Merchant Pendant**  
 in Hand-Rubbed  
 Antique Brass with  
 Clear Glass  
 O/A Height: 24"  
 Fixture Height: 18"  
 Width: 11.75"  
 Canopy: 5.25" Round

**Finishes:**  
 AN, BZ, HAB, PN  
**Glass Options:** CG

**Socket:**  
 3 - Candelabra  
**Wattage:** 3 - 60 C

**Designer:**  
 Thomas O'Brien



TOB5030BZ



**CHC2114PN**  
**Amphora Small**  
**Bell Jar Pendant**  
 in Polished Nickel  
 Height: 25.75"  
 Width: 12.25"  
 Canopy: 5.75" Round

**Finishes:**  
 AB, AN, BZ, PN  
**Glass Options:** CG

**Socket:**  
 3 - Candelabra  
**Wattage:** 3 - 60 C

**Designer:**  
 E. F. Chapman  
 ©EFC DESIGNS

CHC2114AB



CHC2114BZ





**TOB4212PN**  
**Merchant Semi-Flush**  
**in Polished Nickel**  
**with Clear Glass**  
Height: 18"  
Width: 11.25"  
Canopy: 5.25" Round

**Finishes:**  
AN, BZ, HAB, PN  
**Glass Options:** CG

**Socket:**  
3 - Candelabra  
**Wattage:** 3 - 60 C

**Designer:**  
Thomas O'Brien



# FLUSH MOUNTS CEILING

**SN4001PN**  
**Trillion Large**  
**Flush Mount in**  
**Polished Nickel**  
Height: 14.25"  
Width: 21"  
Canopy: 5" Round

**Finishes:** HAB, PN  
**Trim Options:** CG

**Socket:**  
10 - Candelabra  
**Wattage:** 10 - 60 B

**Designer:**  
Joe Nye



**NW4001BSL-CG**  
**Bianca Flared**  
**Semi-Flush Mount**  
**in Burnished**  
**Silver Leaf**  
 Height: 9"  
 Width: 20"  
 Canopy: 5" Round

**Finishes:** BSL, GI  
**Trim Options:** CG

**Socket:**  
 4 - Candelabra  
**Wattage:** 4 - 60 C

**Designer:**  
 Niermann Weeks



**NW4001GI-CG**



**NW4007BSL**  
**Alexandria Large**  
**Flush Mount**  
**in Burnished**  
**Silver Leaf**  
 Height: 21"  
 Width: 16"  
 Canopy: 5" Round

**Finishes:** BSL, GI  
**Trim Options:** CG

**Socket:**  
 6 - Candelabra  
**Wattage:** 6 - 60 C

**Designer:**  
 Niermann Weeks



**NW4007GI**



**NW4051GI-CG**  
**Calais Large Semi-**  
**Flush in Gilded Iron**  
 Height: 12"  
 Width: 26"  
 Canopy: 5" Round

**Finishes:** BSL, GI  
**Trim Options:** CG

**Socket:**  
 6 - Candelabra  
**Wattage:** 6 - 60 C

**Designer:**  
 Niermann Weeks



**ARN4004BSL-CG**  
**Renwick Flush Mount**  
**in Burnished Silver Leaf**  
**with Crystal**  
Height: 8.25"  
Width: 16.5"

**Finishes:** BSL, G  
**Trim Options:** CG

**Socket:**  
3 - Candelabra  
**Wattage:** 3 - 40 C

**Designer:**  
AERIN



**ARN4004G-CG**



**ARN4120BSL**  
**Lynn Flush Mount in**  
**Burnished Silver Leaf**  
**with Clear Glass**  
Height: 10.25"  
Width: 16.5"

**Finishes:** BSL, HAB

**Socket:** 8 - Keyless  
**Wattage:** 8 - 60 G

**Designer:**  
AERIN



**ARN4120HAB**



**ARN4102BSL-CG**  
**Jacqueline Flush**  
**Mount in Burnished**  
**Silver Leaf with**  
**Clear Glass**  
Height: 12.25"  
Width: 18"

**Finishes:**  
BSL, HAB  
**Trim Options:**  
CG, WG

**Socket:**  
4 - Candelabra  
**Wattage:** 4 - 40 C

**Designer:**  
AERIN



**ARN4102HAB-WG**



**NW4015AGP**  
**Lyon Small Flush**  
**Mount in Antique**  
**Gild and Polychrome**  
**with Crystal**  
Height: 9"  
Width: 12"  
Canopy: 12" Round

**Finishes:** AGP  
**Trim Options:** CG

**Socket:**  
3 - Candelabra  
**Wattage:** 3 - 60 C

**Designer:**  
Niermann Weeks



**CHC4207PS-SG**  
Paris Flea Market  
Medium Flush  
Mount in Polished  
Silver with  
Seeded Glass  
Height: 9"  
Width: 13"

**Finishes:**  
AB, PS, SHS  
**Trim Options:** SG

**Socket:**  
2 - Candelabra  
**Wattage:** 2 - 60 C

**Designer:**  
E. F. Chapman

©EFC DESIGNS



**CHC4206PS-SG**  
Paris Flea Market  
Small Flush  
Mount in Polished  
Silver with  
Seeded Glass  
Height: 7.5"  
Width: 10"

**Finishes:**  
AB, PS, SHS  
**Trim Options:** SG

**Socket:**  
2 - Candelabra  
**Wattage:** 2 - 60 C

**Designer:**  
E. F. Chapman

©EFC DESIGNS



**CHC4207AB-SG**



**CHC4206AB-SG**



**CHC4207SHS-SG**



**CHC4206SHS-SG**



**ARN4006PN-CG**  
**Presbourg Flush Mount in Polished Nickel with Crystal**  
 Height: 5"  
 Width: 15.25"

**Finishes:** HAB, PN  
**Glass Options:** CG, FG

**Socket:**  
 3 - Candelabra  
**Wattage:** 3 - 60 C

**Designer:**  
 AERIN



**ARN4006HAB-FG**



**ARN4001PN-WG**  
**Rosehill Large Flush Mount in Polished Nickel with White Strie Glass**  
 Height: 10.25"  
 Width: 21"  
 Canopy: 5.75" Round

**Finishes:** HAB, PN  
**Glass Options:** WG

**Socket:**  
 4 - Candelabra  
**Wattage:** 4 - 40 C

**Designer:**  
 AERIN



**ARN4001HAB-WG**



**ARN4002PN-WG**  
**Rosehill Elongated Semi-Flush in Polished Nickel with White Strie Glass**  
 Height: 14"  
 Width: 9.5"  
 Canopy: 5.75" Round

**Finishes:** HAB, PN  
**Glass Options:** WG

**Socket:** Keyless  
**Wattage:** 60 A

**Designer:**  
 AERIN



**ARN4002HAB-WG**





**ARN4000HAB-WG**  
**Rosehill Semi-Flush**  
**in Hand-Rubbed**  
**Antique Brass with**  
**White Strie Glass**  
Height: 10.25"  
Width: 16"  
Canopy: 5.75" Round

**Finishes:** HAB, PN  
**Glass Options:** WG

**Socket:**  
3 - Candelabra  
**Wattage:** 3 - 60 B

**Designer:**  
AERIN



**SE4100PN**  
**Constellation Small**  
**Flush Mount in**  
**Polished Nickel with**  
**Antique Mirror**  
 Height: 7.75"  
 Width: 19.75"  
 Canopy: 5" Round

**Finishes:**  
 BZ, HAB, PN  
**Glass Options:** AM

**Socket:**  
 3 - Candelabra  
**Wattage:** 3 - 60 C

**Designer:**  
 Studio VC

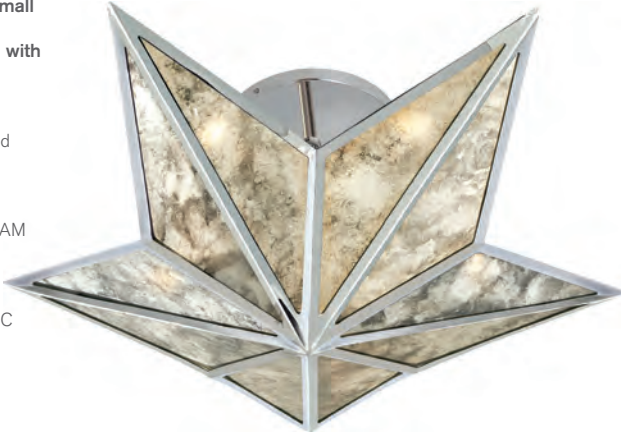

**SC4000PN**  
**Star Flush Mount in**  
**Polished Nickel**  
 Height: 2.5"  
 Width: 14.5"

**Finishes:**  
 AS, BZ, HAB, PN

**Socket:** Keyless  
**Wattage:** 60 A

**Designer:**  
 Eric Cohler



**SE4100HAB**

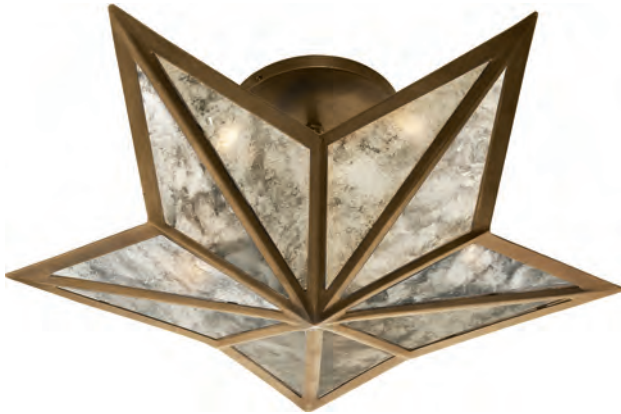

**SC4000HAB**



**SE4100BZ**



**SC4000BZ**



**SK4000GI**  
**Ré Flush Mount**  
**in Gilded Iron**  
Height: 6"  
Width: 22"  
Canopy: 5" Round

**Finishes:** GI

**Socket:**  
2 - Candelabra  
**Wattage:** 2 - 60 B

**Note:** Ceiling  
or Wall Mount

**Designer:**  
Suzanne Kasler



**KW4070PN**  
**Strada Medium**  
**Flush Mount in**  
**Polished Nickel**  
 Height: 11"  
 Width: 28"

**Finishes:**  
 AI, BSL, G, PN

**Socket:**  
 10 - Candelabra

**Wattage:**  
 10 - 40 C

**Designer:**  
 Kelly Wearstler



KW4070AI



**KW4071G**  
**Strada Large Flush**  
**Mount in Gold**  
 Height: 14.5"  
 Width: 40"

**Finishes:** AI, G, PN

**Socket:**  
 10 - Candelabra

**Wattage:**  
 10 - 60 C

**Designer:**  
 Kelly Wearstler



**SK5200PN**  
**Soleil Small Pendant**  
in Polished Nickel  
with Frosted Glass  
Height: 14"  
Width: 16" (Points)  
Canopy: 5.25" Round

**Finishes:**  
BZ, HAB, PN  
**Glass Options:** FG

**Socket:** Keyless  
**Wattage:** 60 B

**Note:** Custom  
Height Available

**Designer:**  
Suzanne Kasler

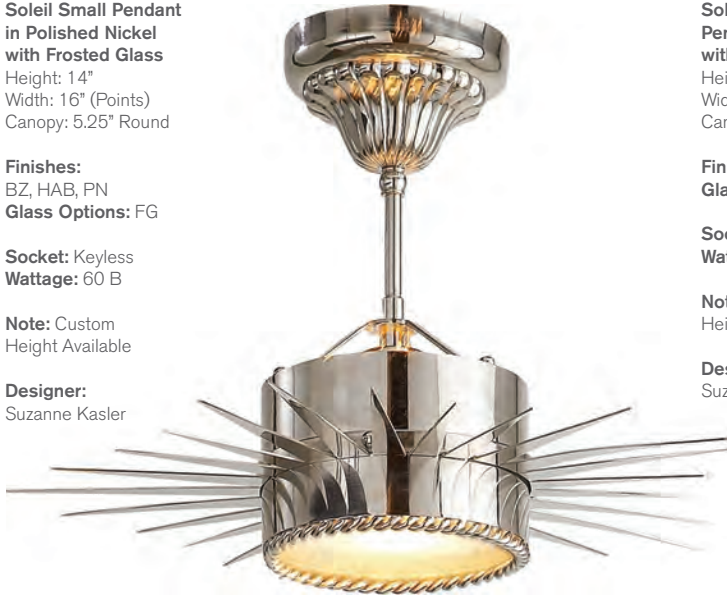

**SK5201BZ**  
**Soleil Medium**  
Pendant in Bronze  
with Frosted Glass  
Height: 15"  
Width: 24" (Points)  
Canopy: 5.25" Round

**Finishes:** BZ, HAB, PN  
**Glass Options:** FG

**Socket:** Keyless  
**Wattage:** 60 A

**Note:** Custom  
Height Available

**Designer:**  
Suzanne Kasler



**SK5202HAB**  
**Soleil Large Pendant**  
in Hand-Rubbed  
Antique Brass with  
Frosted Glass  
Height: 14.5"  
Width: 28" (Points)  
Canopy: 5.25" Round

**Finishes:** BZ, HAB, PN  
**Glass Options:** FG

**Socket:** 2 - Keyless  
**Wattage:** 2 - 60 A

**Note:** Custom  
Height Available

**Designer:**  
Suzanne Kasler





**BBL5024SS-S**  
**Reflection Semi-Flush**  
**Pendant in Soft**  
**Silver with Silk Shade**  
O/A Height: 14"  
Width: 15"  
Canopy: 10" Round

**Finishes:**  
BZ, SB, SS  
**Shade Treatments:** S  
**Shade Details:**  
15" x 15" x 6" Silk

**Socket:** 2 - Keyless  
**Wattage:** 2 - 75 A

**Designer:**  
Barbara Barry



**BBL5024SB-S**



**BBL5024BZ-S**



**KW4012AB**  
**Melange Small Flush Mount Lamp in Antique-Burnished Brass with Alabaster**  
 Height: 4.5"  
 Width: 14"  
 Backplate: 8" Round

**Finishes:** AB, BZ

**Socket:** 2 - Keyless  
**Wattage:** 2 - 40 B

**Designer:**  
 Kelly Wearstler

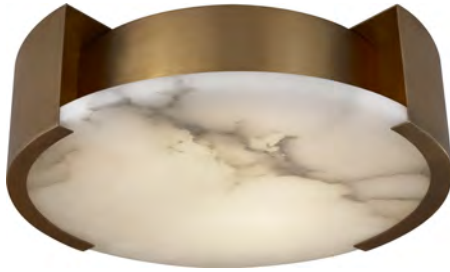

**KW4012BZ**



**KW4013AB**  
**Melange Large Flush Mount Lamp in Antique-Burnished Brass with Alabaster**  
 Height: 5"  
 Width: 17"  
 Backplate: 8" Round

**Finishes:** AB, BZ

**Socket:** 2 - Keyless  
**Wattage:** 2 - 40 B

**Designer:**  
 Kelly Wearstler



**KW4013BZ**



**TOB4221HAB-AM**  
**Venice Large Square Flush Mount in Hand-Rubbed Antique Brass with Antique Mercury Glass**  
 Height: 5.5"  
 Width: 17.5"  
 Backplate: 12.25" Square

**Finishes:**  
 BZ, HAB, PN  
**Glass Options:** AM

**Socket:** 2 - Candelabra  
**Wattage:** 2 - 60 B

**Designer:**  
 Thomas O'Brien



**TOB4221BZ-AM**





**KW4060AB-CDG**  
Precision Small Square  
Flush Mount in  
Antique-Burnished Brass  
with Clouded Glass  
Height: 4.5"  
Width: 6"  
Canopy: 4" Square

**Finishes:**  
AB, BZ, PN  
**Glass Options:** CDG

**Socket:** GU10  
**Wattage:** 35 J

**Designer:**  
Kelly Wearstler



**KW4060BZ-CDG**



**KW4061AB-CDG**  
Precision Large  
Square Flush Mount  
in Antique-Burnished  
Brass with  
Clouded Glass  
Height: 3.5"  
Width: 12.5"  
Canopy: 9.5" Square

**Finishes:**  
AB, BZ, PN  
**Glass Options:** CDG

**Socket:**  
2 - Candelabra  
**Wattage:** 2 - 40 B

**Designer:**  
Kelly Wearstler

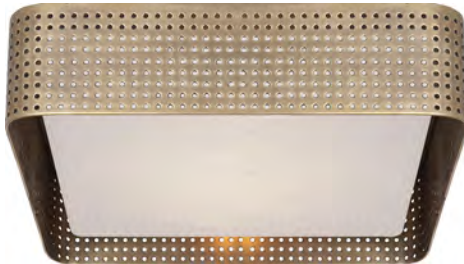

**KW4061BZ-CDG**



**KW4050G-FR**  
Utopia Round Sconce  
in Gild with  
Fractured Glass  
Height: 4.25"  
Width: 14"  
Backplate: 11"

**Finishes:** AI, G  
**Glass Options:** FR

**Socket:** 2 - Keyless  
**Wattage:** 2 - 60 A

**Designer:**  
Kelly Wearstler



**KW4050AI-FR**



**AH4200PN-FG**  
**Randolph Small**  
**Flush Mount in**  
**Polished Nickel**  
 Height: 4.5"  
 Width: 11.25"

**Finishes:**  
 BZ, HAB, PN  
**Glass Options:** FG

**Socket:** 2 - Keyless  
**Wattage:** 2 - 40 B

**Designer:**  
 Alexa Hampton



**AH4201PN-FG**  
**Randolph Large**  
**Flush Mount in**  
**Polished Nickel**  
 Height: 4.5"  
 Width: 14"

**Finishes:**  
 AN, BZ, HAB, PN  
**Glass Options:** FG

**Socket:** 2 - Keyless  
**Wattage:** 2 - 60 B

**Designer:**  
 Alexa Hampton



**AH4200HAB-FG**



**AH4201HAB-FG**



**AH4200BZ-FG**



**AH4201BZ-FG**



**SK4010PN-FG**  
**Montpelier Small Flush**  
Mount in Polished  
Nickel with  
Frosted Glass  
Height: 6"  
Width: 11"

**Finishes:**  
AN, BZ, HAB, PN  
**Glass Options:**  
FG

**Socket:**  
2 - Keyless  
**Wattage:** 2 - 60 B

**Designer:**  
Suzanne Kasler



**SK4011PN-FG**  
**Montpelier Large**  
Flush Mount in  
Polished Nickel  
with Frosted Glass  
Height: 6"  
Width: 16"

**Finishes:**  
AN, BZ, HAB, PN  
**Glass Options:**  
FG

**Socket:**  
3 - Keyless  
**Wattage:** 3 - 60 B

**Designer:**  
Suzanne Kasler



**SK4010HAB-FG**



**SK4011HAB-FG**



**SK4010BZ-FG**



**SK4011BZ-FG**





AH4018PN/CG-FG

Lana Small Flush Mount in Polished Nickel and Clear Glass Rods with Frosted Glass  
Height: 5.25"  
Width: 15"  
Backplate: 15"

**Finishes:**

GM/CG,  
NB/CG,  
PN/CG

**Glass Options:**

FG

**Socket:**

2 - Candelabra

**Wattage:** 2 - 40 B

**Designer:**

Alexa Hampton



AH4018NB/CG-FG



AH4016PN/CG-FG

Sophia Small Flush Mount in Polished Nickel and Clear Glass Rods with Frosted Glass  
Height: 5.5"  
Width: 13.5"

**Finishes:**

GM/CG, NB/CG,  
PN/CG

**Glass Options:**

FG

**Socket:**

2 - Candelabra

**Wattage:** 2 - 40 B

**Designer:**

Alexa Hampton



AH4017NB/CG-FG

Sophia 17" Flush Mount in Natural Brass and Clear Glass Rods with Frosted Glass  
Height: 4.75"  
Width: 17.25"

**Finishes:**

GM/CG,  
NB/CG, PN/CG

**Glass Options:**

FG

**Socket:**

3 - Candelabra

**Wattage:** 3 - 40 B

**Designer:**

Alexa Hampton



AH4014PN/CG-FG

Basil Small Flush Mount in Polished Nickel and Clear Glass Rods with Frosted Glass  
Height: 5.25"  
Width: 11.25"

**Finishes:**

GM/CG, NB/CG,  
PN/CG

**Glass Options:**

FG

**Socket:**

2 - Candelabra

**Wattage:** 2 - 40 B

**Designer:**

Alexa Hampton



AH4015NB/CG-FG

Basil 17" Flush Mount in Natural Brass and Clear Glass Rods with Frosted Glass  
Height: 4.75"  
Width: 17.25"

**Finishes:**

GM/CG, NB/CG,  
PN/CG

**Glass Options:**

FG

**Socket:**

3 - Keyless

**Wattage:**  
3 - 60 B

**Designer:**

Alexa Hampton



**SS4010PN-FG**  
**Openwork Small**  
**Flush Mount in**  
**Polished Nickel**  
**with Frosted Glass**  
 Height: 4"  
 Width: 10"

**Finishes:**  
 AN, BZ, CH, HAB, PN  
**Glass Options:** FG

**Socket:**  
 2 - Candelabra  
**Wattage:** 2 - 40 C

**Designer:**  
 Studio VC



**SS4011PN-FG**  
**Openwork Large**  
**Flush Mount in**  
**Polished Nickel**  
**with Frosted Glass**  
 Height: 5"  
 Width: 13.5"

**Finishes:**  
 AN, BZ, CH, HAB, PN  
**Glass Options:** FG

**Socket:**  
 2 - Candelabra  
**Wattage:** 2 - 40 C

**Designer:**  
 Studio VC



**SS4010HAB-FG**



**SS4011HAB-FG**



**SS4010BZ-FG**



**SS4011BZ-FG**



**AH4029PN-WG**  
Rachel Small  
Flush Mount in  
Polished Nickel  
with White Glass  
Height: 4"  
Width: 13.5"

**Finishes:**  
GM, NB, PN  
**Glass Options:** WG

**Socket:** 2 - Keyless  
**Wattage:** 2 - 60 B

**Designer:**  
Alexa Hampton



**AH4030PN-WG**  
Rachel Large  
Flush Mount in  
Polished Nickel  
with White Glass  
Height: 5"  
Width: 18"

**Finishes:**  
GM, NB, PN  
**Glass Options:**  
WG

**Socket:** 3 - Keyless  
**Wattage:** 3 - 60 B

**Designer:**  
Alexa Hampton



**AH4029NB-WG**



**AH4030NB-WG**



**AH4029GM-WG**



**AH4030GM-WG**







**AH4014PN-FG**  
**Basil Small**  
Flush Mount in  
Polished Nickel  
with Frosted Glass  
Height: 5"  
Width: 11.25"

**Finishes:**  
GM, GM/CG,  
NB, NB/CG,  
PN, PN/CG  
**Glass Options:**  
FG

**Socket:**  
2 - Candelabra  
**Wattage:** 2 - 40 B

**Designer:**  
Alexa Hampton



**AH4015PN-FG**  
**Basil Large**  
Flush Mount in  
Polished Nickel  
with Frosted Glass  
Height: 5"  
Width: 17"

**Finishes:**  
GM, GM/CG,  
NB, NB/CG,  
PN, PN/CG  
**Glass Options:**  
FG

**Socket:**  
3 - Keyless  
**Wattage:** 3 - 60 B

**Designer:**  
Alexa Hampton



**AH4014NB-FG**



**AH4015NB-FG**



**AH4014GM-FG**



**AH4015GM-FG**



AH4035PN-FG  
Basil Large  
Flush Mount in  
Polished Nickel  
with Frosted Acrylic  
Height: 12"  
Width: 24"

**Finishes:**  
GM, NB, PN  
**Glass Options:** FA

**Socket:** 3 - Keyless  
**Wattage:** 3 - 60 B

**Designer:**  
Alexa Hampton



AH4035NB-FG



AH4035GM-FG



**AH4021PN-FG**  
**Markos Flush Mount**  
**in Polished Nickel**  
**with Frosted Acrylic**  
Height: 12"  
Width: 26"

**Finishes:**  
GM, NB, PN  
**Glass Options:** FA

**Socket:** 4 - Keyless  
**Wattage:** 4 - 60 B

**Designer:**  
Alexa Hampton



**AH4021NB-FG**



**AH4021GM-FG**



**AH4004WHT-FG**  
**Frank Small Flush Mount in White with Frosted Glass**  
 Height: 4.75"  
 Width: 11.25"

**Finishes:**  
 G, GM, NB, PN, WHT  
**Glass Options:** FG

**Socket:** 2 - Keyless  
**Wattage:** 2 - 60 B

**Designer:**  
 Alexa Hampton



**AH4005WHT-FG**  
**Frank Large Flush Mount in White with Frosted Glass**  
 Height: 4.75"  
 Width: 15"

**Finishes:**  
 GM, NB, PN, WHT  
**Glass Options:** FG

**Socket:** 3 - Keyless  
**Wattage:** 3 - 60 B

**Designer:**  
 Alexa Hampton



**AH4004NB-FG**



**AH4005NB-FG**



**AH4004GM-FG**



**AH4005GM-FG**



**ARN4041WHT**  
**Bolsena Clover Flush**  
**Mount in White**  
**with Frosted Glass**  
Height: 5.75"  
Width: 11.75"

**Finishes:**  
BSL, G, WHT  
**Glass Options:** FG

**Socket:** 2 - Keyless  
**Wattage:** 2 - 60 B

**Designer:**  
AERIN



**ARN4047WHT**  
**Bolsena Deco Flush**  
**Mount in White**  
**with Frosted Glass**  
Height: 5.75"  
Width: 11.75"

**Finishes:**  
BSL, G, WHT  
**Glass Options:** FG

**Socket:** 2 - Keyless  
**Wattage:** 2 - 60 B

**Designer:**  
AERIN



**ARN4041G**



**ARN4047G**



**ARN4041BSL**



**ARN4047BSL**



**AH4016PN-FG**  
**Sophia Small**  
 Flush Mount in  
 Polished Nickel  
 with Frosted Glass  
 Height: 5"  
 Width: 13.5"

**Finishes:**  
 GM, GM/CG,  
 NB, NB/CG,  
 PN, PN/CG  
**Glass Options:**  
 FG

**Socket:**  
 2 - Candelabra  
**Wattage:** 2 - 40 B

**Designer:**  
 Alexa Hampton



**AH4017PN-FG**  
**Sophia Large**  
 Flush Mount in  
 Polished Nickel  
 with Frosted Glass  
 Height: 5"  
 Width: 17"

**Finishes:**  
 GM, GM/CG,  
 NB, NB/CG,  
 PN, PN/CG  
**Glass Options:**  
 FG

**Socket:**  
 3 - Candelabra  
**Wattage:** 3 - 40 B

**Designer:**  
 Alexa Hampton



**AH4016NB-FG**

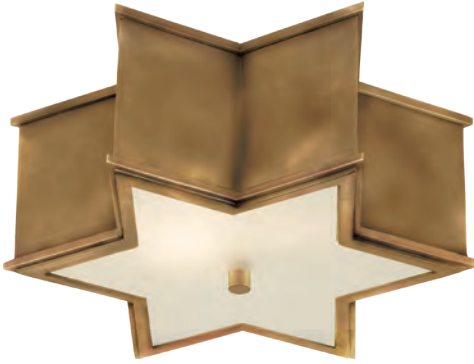

**AH4017NB-FG**



**AH4016GM-FG**

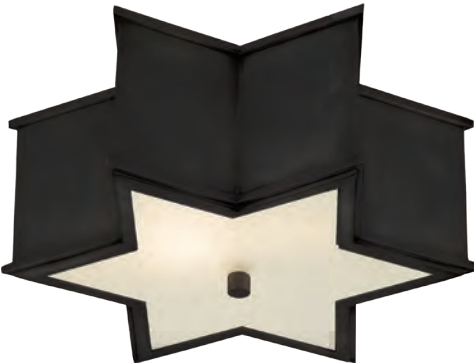

**AH4017GM-FG**



**AH4020PN-FG**  
**Odette Flush Mount**  
in Polished Nickel  
with Frosted Glass  
Height: 4.5"  
Width: 15"

**Finishes:**  
GM, NB, PN  
**Glass Options:**  
FG

**Socket:**  
2 - Candelabra  
**Wattage:** 2 - 40 B

**Designer:**  
Alexa Hampton



**AH4025PN-FG**  
**Balthazar Flush Mount**  
in Polished Nickel  
with Frosted Glass  
Height: 4.5"  
Width: 14"

**Finishes:**  
GM, NB, PN  
**Glass Options:**  
FG

**Socket:**  
3 - Keyless  
**Wattage:** 3 - 60 B

**Designer:**  
Alexa Hampton



**AH4020NB-FG**



**AH4025NB-FG**



**AH4020GM-FG**

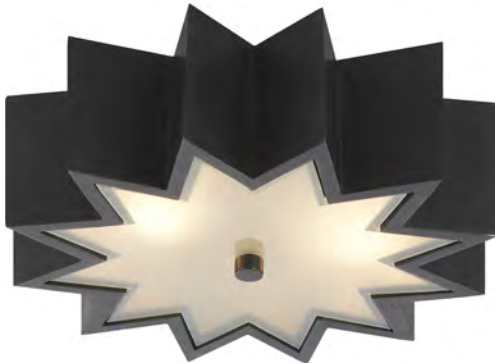

**AH4025GM-FG**



**TOB4130AN-WG**  
**Tilden Small**  
 Flush Mount in  
 Antique Nickel  
 with White Glass  
 Height: 5"  
 Width: 11.25"

**Finishes:**  
 AN, BZ, HAB, PN  
**Glass Options:**  
 WG

**Socket:**  
 2 - Keyless  
**Wattage:** 2 - 40 B

**Designer:**  
 Thomas O'Brien



**TOB4131AN-WG**  
**Tilden Large**  
 Flush Mount in  
 Antique Nickel  
 with White Glass  
 Height: 6"  
 Width: 17"

**Finishes:**  
 AN, BZ, HAB, PN  
**Glass Options:**  
 WG

**Socket:**  
 4 - Keyless  
**Wattage:** 4 - 60 B

**Designer:**  
 Thomas O'Brien



**TOB4130HAB-WG**



**TOB4131HAB-WG**



**TOB4130BZ-WG**



**TOB4131BZ-WG**





**AH4000BN-FG**  
**Audrey Flush Mount**  
in Brushed Nickel  
with Frosted Glass  
Height: 5.25"  
Width: 16"

**Finishes:**  
BN, G, GM, NB  
**Glass Options:**  
FG

**Socket:**  
2 - Keyless  
**Wattage:** 2 - 60 B

**Designer:**  
Alexa Hampton



**AH4010PN-FG**  
**Vivien Flush Mount**  
in Polished Nickel  
with Frosted Glass  
Height: 5"  
Width: 13.25"

**Finishes:**  
GM, NB, PN  
**Glass Options:**  
FG

**Socket:**  
2 - Keyless  
**Wattage:** 2 - 60 B

**Designer:**  
Alexa Hampton



**AH4000NB-FG**



**AH4010NB-FG**



**AH4000GM-FG**



**AH4010GM-FG**





**SS4015BZ-WG**  
Siena Small Flush  
Mount in Bronze  
with White Glass  
Height: 4.25"  
Width: 11.75"

**Finishes:** AN, BZ,  
CH, HAB, PN  
**Glass Options:** WG

**Socket:** 2 - Keyless  
**Wattage:** 2 - 40 B

**Designer:**  
Studio VC



**SS4016BZ-WG**  
Siena Large Flush  
Mount in Bronze  
with White Glass  
Height: 4.75"  
Width: 14"

**Finishes:** AN, BZ,  
CH, HAB, PN  
**Glass Options:** WG

**Socket:** 2 - Keyless  
**Wattage:** 2 - 60 B

**Designer:**  
Studio VC



**SS4015HAB-WG**



**SS4016HAB-WG**



**SS4015PN-WG**



**SS4016PN-WG**



**CHC4391PN-WG**  
**Alderly Small**  
**Flush Mount in**  
**Polished Nickel**  
**with White Glass**  
 Height: 4.25"  
 Width: 13"

**Finishes:**  
 AB, BZ, PN  
**Glass Options:**  
 WG

**Socket:**  
 2 - Candelabra  
**Wattage:** 2 - 60 C

**Designer:**  
 E. F. Chapman

©EFC DESIGNS



**CHC4392PN-WG**  
**Alderly Flush Mount**  
**in Polished Nickel**  
**with White Glass**  
 Height: 4.25"  
 Width: 16"

**Finishes:**  
 AB, BZ, PN  
**Glass Options:**  
 WG

**Socket:**  
 2 - Candelabra  
**Wattage:** 2 - 60 C

**Designer:**  
 E. F. Chapman

©EFC DESIGNS



**CHC4391AB-WG**



**CHC4392AB-WG**



**CHC4391BZ-WG**



**CHC4392BZ-WG**



**TOB4161PN-WG**  
Eden Medium  
Flush Mount in  
Polished Nickel  
with White Glass  
Height: 4.25"  
Width: 10.25"

**Finishes:**  
AN, BZ, HAB, PN  
**Glass Options:** WG

**Socket:** 2 - Keyless  
**Wattage:** 2 - 40 A

**Designer:**  
Thomas O'Brien



**TOB4162PN-WG**  
Eden Large  
Flush Mount in  
Polished Nickel  
with White Glass  
Height: 4.75"  
Width: 13"

**Finishes:**  
AN, BZ, HAB, PN  
**Glass Options:**  
WG

**Socket:** 2 - Keyless  
**Wattage:** 2 - 60 A

**Designer:**  
Thomas O'Brien



**TOB4161HAB-WG**



**TOB4162HAB-WG**



**TOB4161BZ-WG**



**TOB4162BZ-WG**



**TOB4206PN-CG**  
**Garey Flush Mount**  
 in Polished Nickel  
 with Industrial  
 Prismatic Glass  
 Height: 4"  
 Width: 11.25"

**Finishes:**  
 BZ, HAB, PN  
**Glass Options:** CG

**Socket:** 2 - Keyless  
**Wattage:** 2 - 40 B

**Designer:**  
 Thomas O'Brien



**TOB4203PN**  
**Calliope Marine**  
 Flush Mount in  
 Polished Nickel  
 Height: 4.5"  
 Width: 11.5"

**Finishes:**  
 BZ, CH, HAB, PN  
**Glass Options:** WG

**Socket:** 2 - Keyless  
**Wattage:** 2 - 60 B

**Designer:**  
 Thomas O'Brien



**TOB4206HAB-CG**



**TOB4203HAB**



**TOB4206BZ-CG**



**TOB4203BZ**



**TOB4216PN-WG**  
Newhouse Circular  
Flush Mount in  
Polished Nickel  
with White Glass  
Height: 4.5"  
Width: 12.25"

**Finishes:**  
AN, BZ, HAB, PN  
**Glass Options:** WG

**Socket:** 2 - Keyless  
**Wattage:** 2 - 60 B

**Designer:**  
Thomas O'Brien



**TOB4215PN-WG**  
Newhouse Block  
Wall/Ceiling Light  
in Polished Nickel  
with White Glass  
Height: 3.5"  
Width: 6.25" x 10.25"

**Finishes:**  
AN, BZ, HAB, PN  
**Glass Options:** WG

**Socket:** Keyless  
**Wattage:** 60 B

**Designer:**  
Thomas O'Brien



**TOB4216HAB-WG**



**TOB4215HAB-WG**



**TOB4216BZ-WG**



**TOB4215BZ-WG**







**TOB4011PN-WG**  
**Milton Short**  
Flush Mount in  
Polished Nickel  
with White Glass  
Height: 6"  
Width: 9.5"

**Finishes:**  
AN, BZ, HAB, PN  
**Glass Options:** WG

**Socket:** Keyless  
**Wattage:** 60 B

**Designer:**  
Thomas O'Brien



**TOB4013PN-WG**  
**Milton Large**  
Flush Mount in  
Polished Nickel  
with White Glass  
Height: 6"  
Width: 14.5"

**Finishes:**  
AN, BZ, HAB, PN  
**Glass Options:** WG

**Socket:** 2 - Keyless  
**Wattage:** 2 - 60 B

**Designer:**  
Thomas O'Brien



**TOB4011HAB-WG**



**TOB4013HAB-WG**



**TOB4011BZ-WG**



**TOB4013BZ-WG**



**SL4001PN-WG**  
 Marine Medium  
 Flush Mount in  
 Polished Nickel  
 with White Glass  
 Height: 4.75"  
 Width: 8.25"

**Finishes:**  
 AN, BZ, CH, HAB, PN  
**Glass Options:** WG

**Socket:** Keyless  
**Wattage:** 60 B

**Designer:**  
 E. F. Chapman

©EFC DESIGNS



**SL4002PN-WG**  
 Marine Large  
 Flush Mount in  
 Polished Nickel  
 with White Glass  
 Height: 7"  
 Width: 12.75"

**Finishes:**  
 AN, BZ, CH, HAB, PN  
**Glass Options:** WG

**Socket:** 2 - Keyless  
**Wattage:** 2 - 60 B

**Designer:**  
 E. F. Chapman

©EFC DESIGNS



**SL4001AN-WG**



**SL4002BZ-WG**



**SL4001HAB-WG**



**SL4002HAB-WG**



**CHC4201PN**  
Crown Small Flush  
Mount in  
Polished Nickel  
Height: 5.5"  
Width: 7"

**Finishes:**  
AB, AN, BZ, PN  
**Glass Options:** WG

**Socket:** Keyless  
**Wattage:** 60 B

**Designer:**  
E. F. Chapman

©EFC DESIGNS



CHC4201AB



**CHC4202AN**  
Crown Medium  
Flush Mount  
in Antique Nickel  
Height: 7"  
Width: 12"

**Finishes:**  
AB, AN, BZ, PN  
**Glass Options:** WG

**Socket:** 2 - Keyless  
**Wattage:** 2 - 60 B

**Designer:**  
E. F. Chapman

©EFC DESIGNS



CHC4202BZ



**CHC4203PN**  
Crown Large Flush  
Mount in  
Polished Nickel  
Height: 7.5"  
Width: 15.5"

**Finishes:**  
AB, AN, BZ, PN  
**Glass Options:** WG

**Socket:** 2 - Keyless  
**Wattage:** 2 - 60 B

**Designer:**  
E. F. Chapman

©EFC DESIGNS



CHC4203AB



**TOB4084PN-WG**  
**Hicks Flush Mount**  
**in Polished Nickel**  
**with White Glass**  
 Height: 6.75"  
 Width: 13.75"

**Finishes:**  
 AN, BZ, HAB, PN  
**Glass Options:**  
 WG

**Socket:** 2 - Keyless  
**Wattage:** 2 - 60 B

**Designer:**  
 Thomas O'Brien



**TOB2082PN-WG**  
**Hicks Oval**  
**Flush Mount**  
**in Polished Nickel**  
**with White Glass**  
 Height: 9"  
 Width: 6"

**Finishes:**  
 AN, BZ, HAB, PN  
**Glass Options:** WG

**Socket:** Keyless  
**Wattage:** 60 B

**Designer:**  
 Thomas O'Brien



**TOB4084HAB-WG**



**TOB2082HAB-WG**



**TOB4084BZ-WG**



**TOB2082BZ-WG**



**TOB4000PN**  
**Perry Ceiling Light**  
in Polished Nickel  
Height: 9"  
Width: 9.5"  
Canopy: 7.25" Round

**Finishes:**  
AN, BZ, HAB, PN  
**Glass Options:** WG

**Socket:** Keyless  
**Wattage:** 60 B

**Designer:**  
Thomas O'Brien



**TOB4006PN-WG**  
**Clark Flush Mount**  
in Polished Nickel  
with White Glass  
Height: 12.75"  
Width: 7.5"  
Canopy: 7.5" Round

**Finishes:**  
AN, BZ, HAB, PN  
**Glass Options:** WG

**Socket:** Keyless  
**Wattage:** 75 A

**Designer:**  
Thomas O'Brien



**TOB4000HAB**



**TOB4006HAB-WG**



**TOB4000BZ**



**TOB4006BZ-WG**



**TOB5150PN-WG**  
Milton Road  
Flush Mount in  
Polished Nickel  
with White Glass  
Height: 18"  
Width: 14.75"  
Canopy: 5.75" Round

**Finishes:**  
AN, BZ, HAB, PN  
**Glass Options:** WG

**Socket:** Keyless  
**Wattage:** 75 A

**Designer:**  
Thomas O'Brien

TOB5150AN-WG



TOB5150HAB-WG



TOB5150BZ-WG



**TOB4261PN-WG**  
Eden Flush Mount  
in Polished Nickel  
with White Glass  
Height: 9"  
Width: 12"  
Canopy: 12" Round

**Finishes:** HAB, PN  
**Glass Options:** WG

**Socket:** 2 - Keyless  
**Wattage:** 2 - 40 A

**Designer:**  
Thomas O'Brien



**TOB4261HAB-WG**



**TOB4264PN-WG**  
Eden Semi-Flush  
Pendant in  
Polished Nickel  
with White Glass  
Height: 19.75"  
Width: 10.25"  
Canopy: 4.75" Round

**Finishes:** HAB, PN  
**Glass Options:** WG

**Socket:** 3 - Keyless  
**Wattage:** 3 - 40 A

**Designer:**  
Thomas O'Brien



**TOB4264HAB-WG**



**SL5001PN**  
**Boston Single**  
**Flush Mount in**  
**Polished Nickel**  
 Height: 8.5"  
 Width: 5.5"  
 Canopy: 5" Round

**Finishes:**  
 AN, BZ, HAB, PN  
**Glass Options:** WG

**Socket:** Keyless  
**Wattage:** 60 B

**Note:** Bulb Sold  
 Separately (B-30M)

**Designer:**  
 E. F. Chapman

©EFC DESIGNS



**SL5001PN/SLEG-WG**  
**Boston Single**  
**Flush Mount in**  
**Polished Nickel**  
**with SLEG Shade**  
 Height: 8.5"  
 Width: 5.5"  
 Canopy: 5" Round

**Finishes:**  
 AN, BZ, HAB, PN  
**Glass Options:** WG

**Socket:** Keyless  
**Wattage:** 60 B

**Designer:**  
 E. F. Chapman

©EFC DESIGNS



**SL5001HAB**



**SL5001HAB/SLEG-WG**



**SL5001BZ**



**SL5001BZ/SLEG-WG**





**CHC4132PN-WG**  
Edwardian Open  
Bottom Flush Mount  
in Polished Nickel  
with White Glass  
Height: 11.5"  
Width: 10"  
Canopy: 8" Round

**Finishes:**  
AB, AN, BZ, PN  
**Glass Options:**  
CG, WG

**Socket:** Keyless  
**Wattage:** 60 B

**Designer:**  
E. F. Chapman

©EFC DESIGNS



**SL4121PN-WG**  
Edmond Flush Mount  
in Polished Nickel  
with White School  
House Glass  
Height: 19"  
Width: 14.5"  
Canopy: 5.75" Round

**Finishes:**  
AN, BZ, HAB, PN  
**Glass Options:** WG

**Socket:** Keyless  
**Wattage:** 75 A

**Designer:**  
E. F. Chapman

©EFC DESIGNS



**CHC4132AB-WG**



**SL4121HAB-WG**



**CHC4132BZ-CG**



**SL4121BZ-WG**



**TOB4003PN**  
**Ted Flush Mount**  
 in Polished Nickel  
 Height: 5.5"  
 Width: 15"

**Finishes:**  
 BZ, CH, HAB, PN  
**Glass Options:**  
 WG

**Socket:**  
 2 - Keyless  
**Wattage:** 2 - 60 B

**Designer:**  
 Thomas O'Brien



**CHC4215AN**  
**Square Flush Mount**  
 in Antique Nickel  
 with White Glass  
 Height: 6.25"  
 Width: 14"

**Finishes:**  
 AB, AN, BZ, PN  
**Glass Options:**  
 WG

**Socket:** 2 - Keyless  
**Wattage:** 2 - 60 B

**Designer:**  
 E. F. Chapman

©EFC DESIGNS



**TOB4003HAB**



**CHC4215AB**



**TOB4003BZ**



**CHC4215BZ**



**TOB4220GI**  
**Enrique Flush Mount**  
**in Gilded Iron**  
**with White Glass**  
Height: 4.5"  
Width: 16"

**Finishes:** BSL, GI  
**Glass Options:** WG

**Socket:** 2 - Keyless  
**Wattage:** 2 - 60 B

**Designer:**  
Thomas O'Brien





**CHC4128BZ-CG**  
**Club Small Square**  
Flush Mount  
in Bronze with  
Clear Glass  
Height: 8.25"  
Width: 9"

**Finishes:**  
AB, AN, BZ, PN  
**Glass Options:**  
CG, FG

**Socket:**  
3 - Candelabra  
**Wattage:** 3 - 60 C

**Designer:**  
E. F. Chapman

©EFC DESIGNS



**CHC4129BZ-FG**  
**Club Large Square**  
Flush Mount  
in Bronze with  
Frosted Glass  
Height: 9"  
Width: 13"

**Finishes:**  
AB, AN, BZ, PN  
**Glass Options:**  
CG, FG

**Socket:**  
3 - Candelabra  
**Wattage:** 3 - 60 C

**Designer:**  
E. F. Chapman

©EFC DESIGNS



**CHC4128AB-CG**



**CHC4129AB-FG**



**CHC4128PN-CG**



**CHC4129PN-FG**



**CHC4125PN-CG**  
**Club Small**  
 Hexagonal Flush  
 Mount in Polished  
 Nickel with  
 Clear Glass  
 Height: 8"  
 Width: 11.5"

**Finishes:**  
 AB, AN, BZ, PN  
**Glass Options:**  
 CG, FG

**Socket:**  
 3 - Candelabra  
**Wattage:** 3 - 60 C

**Designer:**  
 E. F. Chapman

©EFC DESIGNS



**CHC4126PN-FG**  
**Club Large**  
 Hexagonal Flush  
 Mount in Polished  
 Nickel with  
 Frosted Glass  
 Height: 8.5"  
 Width: 16"

**Finishes:**  
 AB, AN, BZ, PN  
**Glass Options:**  
 CG, FG

**Socket:**  
 3 - Candelabra  
**Wattage:** 3 - 60 C

**Designer:**  
 E. F. Chapman

©EFC DESIGNS



**CHC4125AB-CG**



**CHC4126AB-FG**



**CHC4125BZ-CG**



**CHC4126BZ-FG**



**CHC4140PN**  
Cornice Hexagonal  
Flush Mount  
in Polished  
Nickel with  
White Glass  
Height: 8.5"  
Width: 18.5"

**Finishes:**  
AB, AN, BZ, PN  
**Glass Options:**  
WG

**Socket:**  
2 - Keyless  
**Wattage:** 2 - 60 B

**Designer:**  
E. F. Chapman

©EFC DESIGNS



**SK4008PN-FG**  
Morris Flush Mount  
in Polished Nickel  
with Frosted Glass  
Height: 5"  
Width: 15.5"

**Finishes:** AZ, GI, PN  
**Glass Options:** FG

**Socket:** 2 - Keyless  
**Wattage:** 2 - 60 B

**Designer:**  
Suzanne Kasler



**CHC4140AB**



**SK4008GI-FG**



**CHC4140BZ**



**SK4008AZ-FG**



**WALL**





DECORATIVE 634  
FUNCTIONAL 802  
PICTURE 838  
BATH 850

**DECORATIVE WALL**

SK2016HAB-NP



**SK2016HAB-NP**  
**Camille Sconce in**  
**Hand-Rubbed Antique**  
**Brass with Natural**  
**Paper Shade**  
Height: 19"  
Width: 5.5"  
Extension: 6"  
Backplate: 4.5" Round

**Finishes:**  
AN, BZ, HAB, PN  
**Shade Treatments:** NP  
**Shade Details:**  
4" x 5.5" x 5.5"

**Socket:** Candelabra  
**Wattage:** 40 B

**Designer:**  
Suzanne Kasler

SK2016BZ-NP



SK2016PN-NP



SK2016AN-NP





**TOB2032PN-NP**  
**Vivian Single**  
**Sconce in Polished**  
**Nickel with Natural**  
**Paper Shade**  
 Height: 13.5"  
 Width: 4"  
 Extension: 8.5"  
 Backplate:  
 4" x 5.25" Rectangle

**Finishes:** HAB, PN  
**Shade Treatments:** NP  
**Shade Details:**  
 3.25" x 4" x 4.25"

**Socket:** Candelabra  
**Wattage:** 40 B

**Designer:**  
 Thomas O'Brien



**TOB2032HAB-NP**



**TOB2033PN-NP**  
**Vivian Double**  
**Sconce in Polished**  
**Nickel with Natural**  
**Paper Shades**  
 Height: 13.5"  
 Width: 13.5"  
 Extension: 8.5"  
 Backplate:  
 4" x 5.25" Rectangle

**Finishes:** HAB, PN  
**Shade Treatments:** NP  
**Shade Details:**  
 3.25" x 4" x 4.25"

**Socket:**  
 2 - Candelabra  
**Wattage:** 2 - 40 B

**Designer:**  
 Thomas O'Brien



**TOB2033HAB-NP**



**CHD1525PN**  
**Ball Sconce**  
**in Polished Nickel**  
**and Crystal**  
Height: 11.75"  
Width: 4.75"  
Extension: 10"  
Backplate: 4.25" Round

**Finishes:** AB, PN

**Socket:** Candelabra  
**Wattage:** 40 C

**Note:**  
CHS104NP Shade  
Sold Separately

**Designer:**  
E. F. Chapman

©EFC DESIGNS



**CHD1525AB**



**CHD1508PN-NP**  
**Cube Sconce in**  
**Polished Nickel and**  
**Crystal with Natural**  
**Paper Shade**  
Height: 15.75"  
Width: 4.25"  
Extension: 9.25"  
Backplate:  
4.25" x 5.75" Rectangle

**Finishes:** AB, PN  
**Shade Treatments:** NP  
**Shade Details:**  
3" x 4" x 5.25"

**Socket:** Candelabra  
**Wattage:** 40 B

**Designer:**  
E. F. Chapman

©EFC DESIGNS



**CHD1508AB-NP**



**CHD2262CG/PN-PL**  
**Paladin Tall Obelisk**  
**Sconce in Crystal and**  
**Polished Nickel with**  
**Natural Percal Shade**  
 Height: 25"  
 Width: 11"  
 Extension: 5.75"  
 Backplate:  
 5" x 23.25" Rectangle

**Finishes:**  
 CG/AB, CG/BZ,  
 CG/PN  
**Shade Treatments:** PL  
**Shade Details:**  
 11" x 11" x 8"  
 Shield

**Socket:** Candelabra  
**Wattage:** 60 C

**Designer:**  
 E. F. Chapman

©EFC DESIGNS



**CHD2262CG/AB-PL**



**CHD2264CG/PN**  
**Paladin Short Modern**  
**Obelisk Sconce**  
**in Crystal and**  
**Polished Nickel**  
 Height: 17"  
 Width: 5"  
 Extension: 5.75"  
 Backplate:  
 5" x 7.25" Rectangle

**Finishes:**  
 CG/AB, CG/BZ,  
 CG/PN

**Socket:** Candelabra  
**Wattage:** 60 C

**Designer:**  
 E. F. Chapman

©EFC DESIGNS



**CHD2264CG/AB**





**CHD2712PN/CG-S**  
**Edgar Medium**  
**Sconce in Polished**  
**Nickel and Crystal**  
**with Silk Shade**  
Height: 18.75"  
Width: 7"  
Extension: 5.75"  
Backplate: 4.25" Square

**Finishes:**  
AB/CG, PN/CG  
**Shade Treatments:** S  
**Shade Details:**  
6" x 7" x 7.5"

**Socket:** Keyless  
**Wattage:** 60 A

**Designer:**  
E. F. Chapman

©EFC DESIGNS



**CHD2713AB/CG-S**  
**Edgar Large Sconce**  
**in Antique-Burnished**  
**Brass and Crystal**  
**with Silk Shade**  
Height: 26.25"  
Width: 8"  
Extension: 5.75"  
Backplate: 4.25" Square

**Finishes:**  
AB/CG, PN/CG  
**Shade Treatments:** S  
**Shade Details:**  
6.5" x 8" x 8.25"

**Socket:** Keyless  
**Wattage:** 60 A

**Designer:**  
E. F. Chapman

©EFC DESIGNS

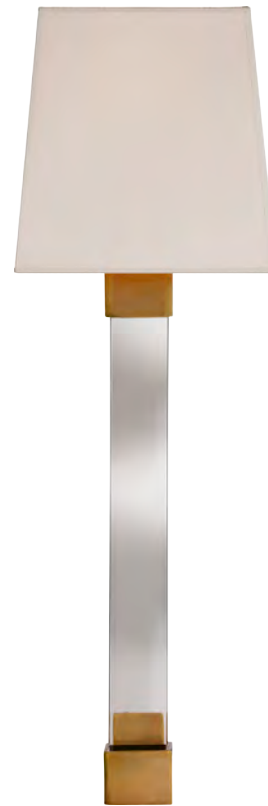

**CHD2957CG/PN-S**  
**Edwin Double Arm**  
**Sconce in Crystal**  
**with Silk Shade**  
Height: 19"  
Width: 13.5"  
Extension: 6.5"  
Backplate: 4" Square

**Finishes:**  
CG/AB, CG/PN  
**Shade Treatments:**  
S  
**Shade Details:**  
12" x 13.5" x 7.5"  
Shield

**Socket:**  
2 - Candelabra  
**Wattage:** 2 - 40 C

**Designer:**  
E. F. Chapman

©EFC DESIGNS



**CHD2957CG/AB-S**





**CHD1156CG/PN**  
**George II Single**  
**Sconce in Crystal**  
**with Polished Nickel**  
Height: 12"  
Width: 4.5"  
Extension: 8.25"  
Backplate: 4.5" Round

**Finishes:** CG/PN

**Socket:** Candelabra  
**Wattage:** 60 C

**Note:**  
Assembly Required

**Designer:**  
E. F. Chapman

©EFC DESIGNS



**CHD1155CG/PN**  
**George II Double**  
**Sconce in Crystal**  
**with Polished Nickel**  
Height: 12"  
Width: 11.5"  
Extension: 7"  
Backplate: 4.5" Round

**Finishes:** CG/PN

**Socket:**  
2 - Candelabra  
**Wattage:** 2 - 60 C

**Note:**  
Assembly Required

**Designer:**  
E. F. Chapman

©EFC DESIGNS



**CHD1154CG/PN**  
**George II Triple**  
**Sconce in Crystal**  
**with Polished Nickel**  
Height: 12"  
Width: 11.5"  
Extension: 8.25"  
Backplate: 4.5" Round

**Finishes:** CG/PN

**Socket:**  
3 - Candelabra  
**Wattage:** 3 - 60 C

**Note:**  
Assembly Required

**Designer:**  
E. F. Chapman

©EFC DESIGNS



**SP2013PN**  
**Huntingdon Double Sconce in Polished Nickel and Crystal**  
 Height: 9.5"  
 Width: 10.25"  
 Extension: 4"  
 Backplate: 4.25" Round

**SP2013HAB**

**Finishes:** HAB, PN

**Socket:**  
 2 - Candelabra  
**Wattage:** 2 - 60 C

**Designer:**  
 J. Randall Powers



**SP2025PN**  
**Olivia Sconce in Polished Nickel and Glass**  
 Height: 13.25"  
 Width: 13"  
 Extension: 5"  
 Backplate: 4" Round

**SP2025HAB**

**Finishes:** HAB, PN

**Socket:**  
 2 - Candelabra  
**Wattage:** 2 - 60 C

**Designer:**  
 J. Randall Powers



**SP2020PN**  
**Laura Sconce in Polished Nickel and Glass**  
 Height: 17"  
 Width: 8"  
 Extension: 5"  
 Backplate: 3" x 9.5" Rectangle

**SP2020HAB**

**Finishes:** HAB, PN

**Socket:**  
 2 - Candelabra  
**Wattage:** 2 - 60 C

**Designer:**  
 J. Randall Powers







**CHD2550BSL-CG**  
**Oslo Sconce in**  
**Burnished Silver Leaf**  
**with Clear Glass**  
Height: 16.75"  
Width: 9.75"  
Extension: 7.5"  
Backplate: 4.25" Round

**Finishes:** BSL, GI  
**Trim Options:** CG

**Socket:**  
2 - Candelabra  
**Wattage:** 2 - 60 C

**Designer:**  
E. F. Chapman

©EFC DESIGNS



**CHD2550GI-CG**



**CHD2551BSL-CG**  
**Oslo Large Sconce**  
**in Burnished Silver Leaf**  
**with Clear Glass**  
Height: 23.5"  
Width: 17"  
Extension: 11.5"  
Backplate: 4.25" Round

**Finishes:** BSL, GI  
**Trim Options:** CG

**Socket:** 3 - Candelabra  
**Wattage:** 3 - 60 C

**Designer:**  
E. F. Chapman

©EFC DESIGNS



**CHD2551GI-CG**



**NW2030VS**  
**Milan Double**  
**Sconce in Venetian**  
**Silver with Crystal**  
 Height: 28"  
 Width: 18"  
 Extension: 9"  
 Backplate: 5" Round

NW2030VG

**Finishes:** VG, VS  
**Trim Options:** CG

**Socket:**  
 2 - Candelabra  
**Wattage:** 2 - 60 C

**Designer:**  
 Niermann Weeks



**NW2051BSL-CG**  
**Calais Medium Sconce**  
**in Burnished Silver**  
**Leaf with Clear Glass**  
 Height: 15.5"  
 Width: 24"  
 Extension: 11.75"  
 Backplate:  
 12" x 5" Decorative

NW2051GI-CG

**Finishes:** BSL, GI  
**Trim Options:** CG

**Socket:**  
 2 - Candelabra  
**Wattage:**  
 2 - 60 C

**Designer:**  
 Niermann Weeks

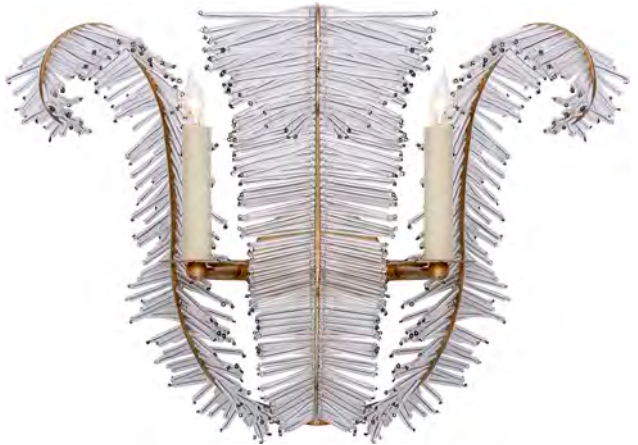
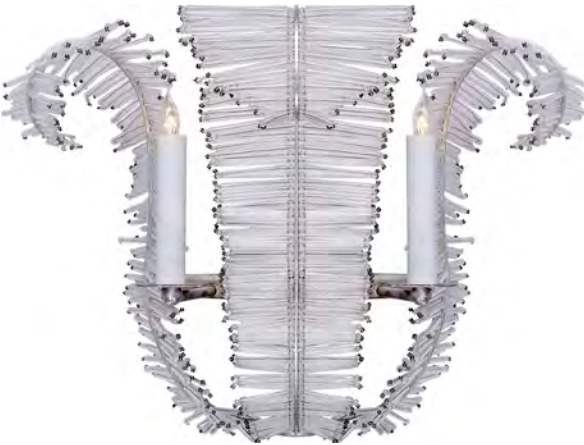



**NW2005RS-CG**  
**Lombardy Sconce**  
**in Rusted Steel**  
Height: 22.5"  
Width: 16.5"  
Extension: 9.75"  
Backplate: 5" Round

**Finishes:** RS  
**Glass Options:** CG

**Socket:**  
2 - Candelabra  
**Wattage:** 2 - 60 C

**Designer:**  
Niermann Weeks



**SN2107HAB**  
**Regency Triple**  
**Scence in Hand-**  
**Rubbed Antique**  
**Brass with**  
**Seeded Glass**  
Height: 18.75"  
Width: 12.5"  
Extension: 7.75"  
Backplate:  
4.25" Round

**Finishes:**  
HAB, PN, SN  
**Trim Options:** SG

**Socket:**  
3 - Candelabra  
**Wattage:** 3 - 40 C

**Designer:**  
Studio VC



**SK2008PN**  
**Hannah Two-Light**  
**Sconce in**  
**Polished Nickel**  
**with Crystal Trim**  
Height: 13"  
Width: 8"  
Extension: 5"  
Backplate: 4.5" Round

**Finishes:** HAB, PN  
**Trim Options:** CG

**Socket:**  
2 - Candelabra  
**Wattage:** 2 - 40 C

**Designer:**  
Suzanne Kasler



**SK2008HAB**



**CHD1555PN-CG**  
**Penhurst Sconce**  
**in Polished Nickel**  
**with Clear Glass**  
Height: 19"  
Width: 12"  
Extension: 7"  
Backplate: 4.5" Round

**Finishes:** GI, PN  
**Trim Options:** CG

**Socket:**  
2 - Candelabra  
**Wattage:** 2 - 60 C

**Designer:**  
E. F. Chapman

©EFC DESIGNS



**CHD1555GI-CG**



**TOB2235BSL**  
**Elizabeth Single**  
**Sconce in Burnished**  
**Silver Leaf with Quartz**  
 Height: 16.75"  
 Width: 4.5"  
 Extension: 8"  
 Backplate:  
 4.5" x 6.5" Oval

**Finishes:** BSL, GI  
**Trim Options:** Q

**Socket:** Candelabra  
**Wattage:** 60 C

**Designer:**  
 Thomas O'Brien

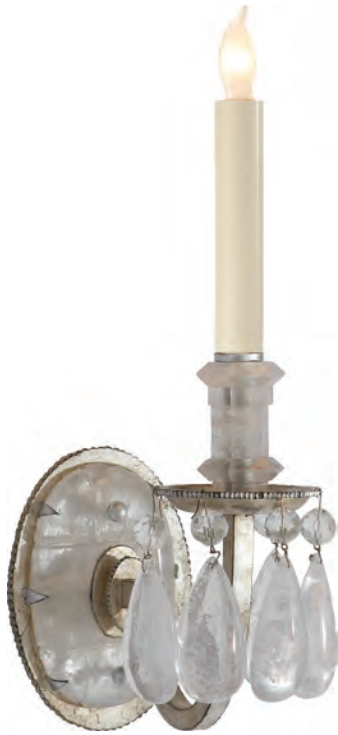

**TOB2236GI**  
**Elizabeth Double**  
**Sconce in Gilded**  
**Iron with Quartz**  
 Height: 14.5"  
 Width: 9.5"  
 Extension: 7.25"  
 Backplate:  
 4.5" x 6.5" Oval

**Finishes:** BSL, GI  
**Trim Options:** Q

**Socket:**  
 2 - Candelabra  
**Wattage:** 2 - 60 C

**Designer:**  
 Thomas O'Brien



**TOB2470GI/CG-PL**  
**Yves Crystal**  
**Single Arm Sconce**  
**in Gilded Iron and**  
**Crystal with Natural**  
**Percalé Shade**  
 Height: 19"  
 Width: 5"  
 Extension: 9"  
 Backplate:  
 3.5" x 8.75" Decorative

**Finishes:** GI/CG  
**Shade Treatments:** PL  
**Shade Details:**  
 3" x 5" x 6"

**Socket:** Candelabra  
**Wattage:** 40 C

**Designer:**  
 Thomas O'Brien



**TOB2471GI/CG-PL**  
**Yves Crystal Double**  
**Arm Sconce in**  
**Gilded Iron and**  
**Crystal with Natural**  
**Percalé Shades**  
 Height: 19"  
 Width: 11.5"  
 Extension: 9"  
 Backplate:  
 4" x 8.75" Decorative

**Finishes:** GI/CG  
**Shade Treatments:**  
 PL  
**Shade Details:**  
 3" x 5" x 6"

**Socket:** 2 - Candelabra  
**Wattage:** 2 - 40 C

**Designer:**  
 Thomas O'Brien



**TOB2237GI**  
**Elizabeth Wall**  
**Sconce in Gilded**  
**Iron with Quartz**  
**and Antique Mirror**  
Height: 14.75"  
Width: 5"  
Extension: 7.75"  
Backplate:  
5" x 12" Rectangle

**Finishes:** BSL, GI  
**Trim Options:** O

**Socket:**  
Candelabra  
**Wattage:** 60 C

**Designer:**  
Thomas O'Brien



**ARN2220BSL-CG**  
**Claret Round Sconce**  
**in Burnished Silver**  
**Leaf with Crystal**  
 Height: 9"  
 Width: 9"  
 Extension: 4.25"  
 Backplate:  
 4.25" Round

**Finishes:** BSL, G  
**Glass Options:** CG

**Socket:** Candelabra  
**Wattage:** 40 C

**Designer:**  
 AERIN



**ARN2220G-CG**



**ARN2007BSL-CG**  
**Lynn Wall Light in**  
**Burnished Silver Leaf**  
**with Clear Glass**  
 Height: 14.25"  
 Width: 12.25"  
 Extension: 7.5"  
 Backplate: 4.5" Round

**Finishes:** BSL, HAB  
**Trim Options:** CG

**Socket:**  
 3 - Candelabra  
**Wattage:** 3 - 60 C

**Designer:**  
 AERIN



**ARN2007HAB-CG**



**ARN2223BSL-CG**  
**Claret Shield Sconce**  
**in Burnished Silver**  
**Leaf with Crystal**  
Height: 10.75"  
Width: 7.25"  
Extension: 4.25"  
Backplate:  
4.25" x 6.5" Oval

**Finishes:** BSL, G  
**Glass Options:** CG

**Socket:** Candelabra  
**Wattage:** 40 C

**Designer:**  
AERIN



**ARN2223G-CG**



**ARN2226BSL-L**  
**Claret Tail Sconce in**  
**Burnished Silver Leaf**  
**with Linen Shade**  
Height: 23.5"  
Width: 10"  
Extension: 5.75"  
Backplate:  
4.5" x 6.5" Oval

**Finishes:** BSL, G  
**Shade Treatments:** L  
**Shade Details:**  
9" x 10" x 8"

**Socket:** Candelabra  
**Wattage:** 40 C

**Designer:**  
AERIN



**ARN2226G-L**



**ARN2026PN**  
**Eaton Sconce in Polished Nickel**  
 Height: 14"  
 Width: 7.5"  
 Extension: 4.75"  
 Backplate: 4.25" x 13" Rectangle

**Finishes:** HAB, PN  
**Glass Options:** CG

**Socket:**  
 2 - Candelabra  
**Wattage:** 2 - 40 C

**Designer:**  
 AERIN

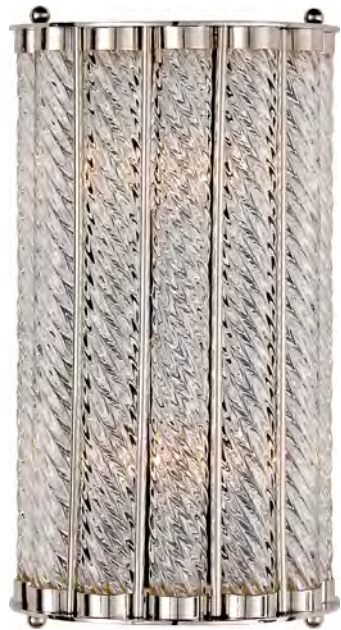

**ARN2026HAB**

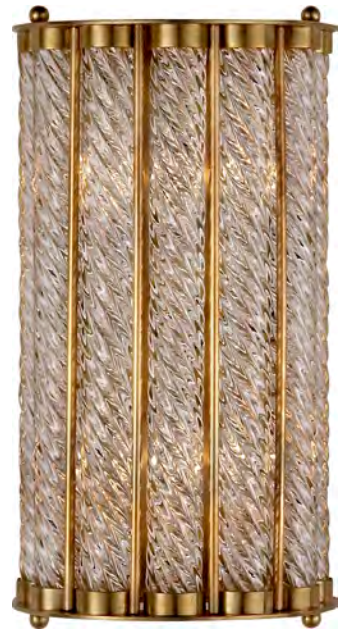

**ARN2040BSL-CG**  
**Rene Wall Sconce in Burnished Silver Leaf with Clear Glass**  
 Height: 15"  
 Width: 9"  
 Extension: 4.75"  
 Backplate: 5.25" x 14.5" Rectangle

**Finishes:** BSL, G  
**Trim Options:** CG

**Socket:** Candelabra  
**Wattage:** 60 B

**Designer:**  
 AERIN



**ARN2040G-CG**





**ARN2124PN-CG**  
**Bonnington Wall**  
**Sconce in Polished**  
**Nickel with Crystal**  
Height: 12"  
Width: 6.75"  
Extension: 4.75"  
Backplate:  
4.5" x 7.25" Rectangle

**Finishes:** HAB, PN  
**Trim Options:** CG

**Socket:** Candelabra  
**Wattage:** 60 B

**Designer:**  
AERIN



**ARN2124HAB-CG**



**ARN2148PN-CG**  
**Eva Wall Sconce**  
**in Polished Nickel**  
**with Crystal**  
Height: 8.25"  
Width: 8"  
Extension: 5.25"  
Backplate:  
4.25" Square

**Finishes:** PN  
**Trim Options:** CG

**Socket:** Candelabra  
**Wattage:** 60 B

**Designer:**  
AERIN



**ARN2105PN-CG**  
**Sanger Large**  
**Sconce in Polished**  
**Nickel with Crystal**  
Height: 13"  
Width: 10.25"  
Extension: 6.25"  
Backplate:  
6.25" x 10"  
Rectangle

**Finishes:** PN  
**Glass Options:** CG

**Socket:**  
2 - Candelabra  
**Wattage:** 2 - 60 C

**Designer:**  
AERIN



**KW2204AB-CRG**  
**Liaison Statement**  
**Sconce in Antique-**  
**Burnished Brass**  
**with Crackle Glass**  
Height: 84.25"  
Width: 12.75"  
Extension: 5.25"  
Backplate:  
Two (2) - 4" Round

**Finishes:**  
AB, BZ, PN  
**Glass Options:** CRG

**Socket:**  
8 - Candelabra  
**Wattage:** 8 - 60 C

**Note:** Requires a  
Smaller Outlet Box

**Designer:**  
Kelly Wearstler



**KW2200PN-CRG**  
**Liaison Single Sconce**  
**in Polished Nickel**  
**with Crackle Glass**

Height: 19"  
Width: 4"  
Extension: 7.5"  
Backplate: 4" Round

**Finishes:** AB, BZ, PN  
**Glass Options:**  
CRG

**Socket:** Candelabra  
**Wattage:** 60 C

**Note:** Requires a  
Smaller Outlet Box

**Designer:**  
Kelly Wearstler



**KW2201AB-CRG**  
**Liaison Double**  
**Sconce in Antique-**  
**Burnished Brass**  
**with Crackle Glass**

Height: 19"  
Width: 9.5"  
Extension: 5.25"  
Backplate: 4" Round

**Finishes:**  
AB, BZ, PN  
**Glass Options:**  
CRG

**Socket:**  
2 - Candelabra  
**Wattage:** 2 - 60 C

**Note:** Requires a  
Smaller Outlet Box

**Designer:**  
Kelly Wearstler



**KW2201BZ-CRG**



**KW2202PN-CRG**  
**Liaison Triple Sconce**  
**in Polished Nickel**  
**with Crackle Glass**

Height: 19"  
Width: 9.5"  
Extension: 7.5"  
Backplate: 4" Round

**Finishes:**  
AB, BZ, PN  
**Glass Options:**  
CRG

**Socket:**  
3 - Candelabra  
**Wattage:** 3 - 60 C

**Note:** Requires a  
Smaller Outlet Box

**Designer:**  
Kelly Wearstler



**KW2202AB-CRG**



**KW2202BZ-CRG**



**S2320PN-NP**  
**Etoile Sconce**  
 in Polished Nickel  
 with Natural  
 Paper Shield  
 Height: 16.5"  
 Width: 5.25"  
 Extension: 5.5"  
 Backplate: 4.5" Square

**Finishes:** AI, GI, PN  
**Shade Treatments:**  
 NP  
**Shade Details:**  
 4.5" x 5.25" x 6.25"

**Socket:** Candelabra  
**Wattage:** 40 B

**Note:** Electrical is  
 behind shade

**Designer:**  
 Ian Fowler

S2320GI-NP

S2320AI-NP



**SR2006PN**  
**Jenna Mirrored**  
**Sconce in**  
**Polished Nickel**  
 Height: 9.5"  
 Width: 5.5"  
 Extension: 4"  
 Backplate: 4.5" Round

**Finishes:** HAB, PN

**Socket:** Candelabra  
**Wattage:** 60 C

**Designer:**  
 John Rosselli

SR2006HAB

SR2006BZ





**CHD1601PN-NP**  
**Cotswold Narrow**  
**Mirrored Sconce in**  
**Polished Nickel with**  
**Natural Paper Shade**  
 Height: 15.5"  
 Width: 4"  
 Extension: 4"  
 Backplate:  
 3.75" x 11.75"  
 Rectangle

**Finishes:** AB, PN  
**Shade Treatments:** NP  
**Shade Details:**  
 3" x 3" x 4"

**Socket:** Candelabra  
**Wattage:** 25 B

**Designer:**  
 E. F. Chapman

©EFC DESIGNS



CHD1601AB-NP



**CHD1602PN-NP**  
**Cotswold Large**  
**Mirrored Sconce in**  
**Polished Nickel with**  
**Natural Paper Shade**  
 Height: 24.25"  
 Width: 6.5"  
 Extension: 5.25"  
 Backplate:  
 6.5" x 18.5" Rectangle

**Finishes:** AB, PN  
**Shade Treatments:** NP  
**Shade Details:**  
 3" x 3" x 4"

**Socket:** Candelabra  
**Wattage:** 25 B

**Designer:**  
 E. F. Chapman

©EFC DESIGNS



CHD1602AB-NP



**CHD2051PN**  
**Lund 12" Single**  
**Sconce in Polished**  
**Nickel with Mirror**  
Height: 12"  
Width: 6"  
Extension: 3"  
Backplate:  
4.25" x 11.25"  
Rectangle

**Finishes:** AB, BZ, PN  
**Glass Options:** FG

**Socket:** Candelabra  
**Wattage:** 60 C

**Designer:**  
E. F. Chapman

©EFC DESIGNS



**CHD2051AB**



**CHD2056PN**  
**Lund 16" Single**  
**Sconce in Polished**  
**Nickel with Mirror**  
Height: 16"  
Width: 6"  
Extension: 3"  
Backplate:  
4.25" x 15.25"  
Rectangle

**Finishes:** AB, BZ, PN

**Socket:** Candelabra  
**Wattage:** 60 C

**Designer:**  
E. F. Chapman

©EFC DESIGNS



**CHD2056AB**



**AH2040PN-PL**  
**Lana Single Sconce**  
**in Polished Nickel and**  
**Mirror with Natural**  
**Percalé Shade**  
 Height: 13.75"  
 Width: 6.5"  
 Extension: 6.5"  
 Backplate: 4" Round

**Finishes:**  
 GM, NB, PN  
**Shade Treatments:** PL  
**Shade Details:**  
 5" x 6.5" x 5.5"

**Socket:**  
 Candelabra  
**Wattage:** 60 B

**Designer:**  
 Alexa Hampton

AH2040NB-PL

AH2040GM-PL



**TOB2330PN-NP**  
**Verona Mirrored**  
**Sconce in Polished**  
**Nickel with Natural**  
**Paper Shade**  
 Height: 15.75"  
 Width: 5.5"  
 Extension: 7.5"  
 Backplate: 4.5" x 8.5"

**Finishes:**  
 HAB, PN, SN, WI  
**Shade Treatments:** NP  
**Shade Details:**  
 3.5" x 5.5" x 6"

**Socket:** Candelabra  
**Wattage:** 40 B

**Designer:**  
 Thomas O'Brien

TOB2330HAB-NP

TOB2330WI-NP





**AH2030PN-NP**  
**Madeline Small**  
Mirrored Sconce in  
Polished Nickel with  
Natural Paper Shade  
Height: 17.5"  
Width: 11"  
Extension: 5.5"  
Backplate:  
3" x 4.5" Rectangle

**Finishes:** BZ, NB, PN  
**Shade Treatments:**  
NP  
**Shade Details:**  
6" x 11" x 8" Shield

**Socket:** Keyless  
**Wattage:** 60 B

**Note:** Requires a  
Smaller Outlet Box

**Designer:**  
Alexa Hampton

AH2030NB-NP

AH2030BZ-NP



**AH2031PN-NP**  
**Madeline Large**  
Mirrored Sconce in  
Polished Nickel with  
Natural Paper Shade  
Height: 26.5"  
Width: 16"  
Extension: 8.5"  
Backplate:  
3" x 4.5" Rectangle

**Finishes:**  
BZ, NB, PN  
**Shade Treatments:**  
NP  
**Shade Details:**  
9" x 16" x 12"  
Shield

**Socket:** Keyless  
**Wattage:** 60 B

**Note:** Requires a  
Smaller Outlet Box

**Designer:**  
Alexa Hampton

AH2031NB-NP

AH2031BZ-NP



**TOB2221PN-AM**  
**Venice Sconce in Polished Nickel with Antique Mirror**  
 Height: 12.5"  
 Width: 12.5"  
 Extension: 4"  
 Backplate: 8.75" Square

**TOB2221HAB-AM**

**TOB2221BZ-AM**

**Finishes:** BZ, HAB, PN  
**Glass Options:** AM

**Socket:** Keyless  
**Wattage:** 60 B

**Designer:**  
 Thomas O'Brien



**TOB2730CG-NP**  
**Jonathan Sconce in Crystal with Natural Paper Shade**  
 Height: 13.5"  
 Width: 6"  
 Extension: 7"  
 Backplate: 5" Round

**TOB2730Q-NP**

**TOB2730ALB-NP**

**Finishes:**  
 ALB, CG, HAB,  
 Q, SHS  
**Shade Treatments:**  
 NP  
**Shade Details:**  
 4" x 6" x 6"

**Socket:** Keyless  
**Wattage:** 60 A

**Designer:**  
 Thomas O'Brien





**SK2052HAB**  
**Quatrefoil Rectangle**  
**Mirrored Sconce**  
**in Hand-Rubbed**  
**Antique Brass**  
Height: 11"  
Width: 6"  
Extension: 4.5"  
Backplate:  
6" x 11" Rectangle

**Finishes:**  
AN, BZ, HAB, PN

**Socket:** Candelabra  
**Wattage:** 60 C

**Designer:**  
Suzanne Kasler

SK2052BZ



**SK2050PN**  
**Quatrefoil Round**  
**Mirrored Sconce in**  
**Polished Nickel**  
Height: 10"  
Width: 10"  
Extension: 4"  
Backplate:  
9.75" Round

**Finishes:**  
AN, BZ, HAB, PN

**Socket:** Candelabra  
**Wattage:** 60 C

**Designer:**  
Suzanne Kasler

SK2050HAB





**SR2013HAB**  
**Lucy Wall Sconce**  
**in Hand-Rubbed**  
**Antique Brass**  
Height: 17"  
Width: 14"  
Extension: 4.75"  
Backplate:  
4.25" x 9" Rectangle

**Finishes:** HAB

**Socket:** Candelabra  
**Wattage:** 60 C

**Designer:**  
John Rosselli



**SK2060GI-AM**  
**Grace Single Sconce**  
**in Gilded Iron**  
**with Smoky Mirror**  
Height: 12.75"  
Width: 11"  
Extension: 4.5"  
Backplate: 5" Round

**Finishes:** AI, GI

**Socket:** Candelabra  
**Wattage:** 60 C

**Designer:**  
Suzanne Kasler

SK2060AI-AM



**AH2016PN-NP**  
**Ida Mirrored Wall**  
**Sconce in Polished**  
**Nickel with Natural**  
**Paper Shade**  
Height: 14.5"  
Width: 12"  
Extension: 14.5"  
Backplate: 5" Round

**Finishes:** GM, NB, PN  
**Shade Treatments:** NP  
**Shade Details:**  
7" x 12" x 9"

**Socket:** Keyless  
**Wattage:** 100 A

**Designer:**  
Alexa Hampton

AH2016NB-NP

AH2016GM-NP



**CHD1185OW**  
**Chelsea Small**  
**Reflection Sconce**  
**in Old White**  
 Height: 8.25"  
 Width: 6.5"  
 Extension: 4.5"  
 Backplate: 5.5" Round

CHD1185TB

**Finishes:** OW, TB

**Socket:** Candelabra  
**Wattage:** 60 C

**Designer:**  
 E. F. Chapman

©EFC DESIGNS



**CHD1186OW**  
**Chelsea Medium**  
**Reflection Sconce**  
**in Old White**  
 Height: 12.25"  
 Width: 10.25"  
 Extension: 4.5"  
 Backplate: 9.5" Round

CHD1186TB

**Finishes:** OW, TB

**Socket:** Candelabra  
**Wattage:** 60 C

**Designer:**  
 E. F. Chapman

©EFC DESIGNS





**SK2002AI**  
**Alice Sconce in**  
**Aged Iron**  
Height: 27.25"  
Width: 11.75"  
Extension: 6"  
Backplate:  
4" x 5.25" Rectangle

**Finishes:** AI  
**Glass Options:** CG

**Socket:** Candelabra  
**Wattage:** 60 C

**Designer:**  
Suzanne Kasler



**SP2003AI**  
**Kate Small Wall**  
**Sconce in Aged Iron**  
**with Antique Mirror**  
Height: 13.75"  
Width: 4.5"  
Extension: 3"  
Backplate: 4.5" Square

**Finishes:** AI

**Socket:** Candelabra  
**Wattage:** 60 C

**Designer:**  
J. Randall Powers



**NW2220BSL**  
**Sophie Bath Sconce in**  
**Burnished Silver Leaf**

Height: 10.5"  
Width: 5"  
Extension: 6.5"  
Backplate:  
3.75" x 5" Rectangle

**Finishes:** BSL, GI

**Socket:** Candelabra  
**Wattage:** 60 C

**Designer:**  
Niermann Weeks



**NW2220GI**



**NW2020BSL**  
**Sophie Sconce in**  
**Burnished Silver Leaf**

Height: 12.5"  
Width: 7"  
Extension: 4.25"  
Backplate:  
6.75" x 12.25"  
Rectangle

**Finishes:** BSL, GI

**Socket:** Candelabra  
**Wattage:** 60 C

**Designer:**  
Niermann Weeks



**NW2020GI**



**NW2226BSL**  
**Sophie Large Linear**  
**Bath Light in**  
**Burnished Silver Leaf**

Height: 5.5"  
Width: 17.5"  
Extension: 4"  
Backplate:  
5.5" x 17.5" Rectangle

**Finishes:** BSL, GI

**Socket:**  
3 - Candelabra  
**Wattage:** 3 - 40 C

**Designer:**  
Niermann Weeks



**NW2115PN**  
**Regent Rectangular**  
**Sconce in**  
**Polished Nickel**  
 Height: 17.5"  
 Width: 5.5"  
 Extension: 3.25"  
 Backplate:  
 5.5" x 17.5" Rectangle

NW2115HAB

NW2115BZ

**Finishes:**  
 AN, BZ, HAB, PN

**Socket:** Candelabra  
**Wattage:** 60 C

**Designer:**  
 Niermann Weeks



**NW2110PN**  
**Regent Oval Sconce**  
**in Polished Nickel**  
 Height: 17.5"  
 Width: 7.5"  
 Extension: 3.5"  
 Backplate:  
 7.5" x 17.5" Oval

NW2110HAB

NW2110BZ

**Finishes:**  
 AN, BZ, HAB, PN

**Socket:** Candelabra  
**Wattage:** 60 C

**Designer:**  
 Niermann Weeks



**NW2311VS**  
**Brittany Double Sconce in Venetian Silver**  
 Height: 15.75"  
 Width: 5"  
 Extension: 3"  
 Backplate: 5" x 15.75"

**Finishes:** AI, VG, VS

**Socket:**  
 2 - Candelabra  
**Wattage:** 2 - 40 C

**Designer:**  
 Niermann Weeks



**NW2311VG**



**NW2311AI**



**NW2011VS-AM**  
**Brittany Single Sconce in Venetian Silver with Antique Mirror**  
 Height: 14"  
 Width: 5"  
 Extension: 3.5"  
 Backplate: 5" x 14"

**Finishes:** AI, VG, VS

**Socket:** Candelabra  
**Wattage:** 40 C

**Designer:**  
 Niermann Weeks



**NW2011VG-AM**



**NW2011AI-AM**



**CHD1183PN**  
**Sussex Small**  
**Framed Sconce in**  
**Polished Nickel with**  
**Antique Mirror**  
Height: 12.25"  
Width: 5"  
Extension: 4.25"  
Backplate:  
2.25" x 7" Rectangle

CHD1183SN

CHD1183AB

**Finishes:**  
AB, PN, SN

**Socket:**  
Candelabra  
**Wattage:** 60 C

**Designer:**  
E. F. Chapman

©EFC DESIGNS



**CHD1184PN**  
**Sussex Medium**  
**Framed Double**  
**Sconce in Polished**  
**Nickel with**  
**Antique Mirror**  
Height: 20.5"  
Width: 9.5"  
Extension: 4.75"  
Backplate:  
4.75" x 17" Rectangle

CHD1184SN

**Finishes:** AB, PN, SN

**Socket:**  
2 - Candelabra  
**Wattage:** 2 - 60 C

**Designer:**  
E. F. Chapman

©EFC DESIGNS



**CHD1174AM/SN**  
**Kensington Beveled**  
**Single Sconce in**  
**Antique Mirror with**  
**Sheffield Nickel**  
Height: 9"  
Width: 4.5"  
Extension: 5.25"  
Backplate:  
4.5" x 7" Rectangle

**Finishes:**  
AB, AM/AB, AM/SN

**Socket:** Candelabra  
**Wattage:** 60 C

**Designer:**  
E. F. Chapman

©EFC DESIGNS

CHD1174AM/AB



CHD1174AB



**CHD1172AM/SN**  
**Kensington Medium**  
**Single Sconce in**  
**Antique Mirror with**  
**Sheffield Nickel**  
Height: 16"  
Width: 6.25"  
Extension: 6.5"  
Backplate:  
4.75" x 16" Rectangle

**Finishes:**  
AB, AM/AB, AM/SN

**Socket:**  
Candelabra  
**Wattage:** 60 C

**Designer:**  
E. F. Chapman

©EFC DESIGNS

CHD1172AM/AB



CHD1172AB







**CHD4175GI**  
**Gramercy Double**  
**Sconce in Gilded Iron**  
Height: 15.75"  
Width: 12.5"  
Extension: 7.75"  
Backplate: 6.75" Round

**Finishes:** GI

**Socket:**  
2 - Candelabra  
**Wattage:** 2 - 60 C

**Designer:**  
E. F. Chapman

©EFC DESIGNS



**CHD4178GI-NP**  
**Gramercy Large**  
**Sconce in Gilded**  
**Iron with Natural**  
**Paper Shade**  
Height: 34"  
Width: 12.5"  
Extension: 7.25"  
Backplate: 4.25" Round

**Finishes:** GI  
**Shade Treatments:** NP  
**Shade Details:**  
11.75" x 12.5" x 8.25"

**Socket:** Keyless  
**Wattage:** 100 A

**Designer:**  
E. F. Chapman

©EFC DESIGNS



**CHD4174GI-NP**  
**Gramercy Sconce**  
**with Shade in**  
**Gilded Iron with**  
**Natural Paper Shade**  
Height: 23"  
Width: 12.5"  
Extension: 7.25"  
Backplate:  
4.25" Round

**Finishes:** GI  
**Shade Treatments:**  
NP  
**Shade Details:**  
11.75" x 12.5" x 8.25"

**Socket:** Keyless  
**Wattage:** 100 A

**Designer:**  
E. F. Chapman

©EFC DESIGNS



**CHD2470OW**  
**Branch Sconce in Old White**  
 Height: 22.75"  
 Width: 15"  
 Extension: 6.5"  
 Backplate: 4.25" Round

CHD2470AI

**Finishes:** AI, GI, OW

**Socket:**  
 2 - Candelabra  
**Wattage:** 2 - 60 C

**Designer:**  
 E. F. Chapman

©EFC DESIGNS



**TOB2753PW-NP**  
**Sierra Tail Sconce in Plaster White with Natural Paper Shade**  
 Height: 45"  
 Width: 11"  
 Extension: 8"  
 Backplate: 4" Square

TOB2753BSL-NP

TOB2753G-NP

**Finishes:**  
 BSL, G, PW  
**Shade Treatments:**  
 NP  
**Shade Details:**  
 10" x 11" x 10"  
 Shield

**Socket:**  
 2 - Candelabra  
**Wattage:** 2 - 40 C

**Designer:**  
 Thomas O'Brien







**ARN2001BSL**  
**Hampton Wall Light in**  
**Burnished Silver Leaf**  
Height: 12"  
Width: 15"  
Extension: 7"  
Backplate: 4" Round

**ARN2001PW**

**ARN2001G**

**Finishes:** BSL, G, PW

**Socket:** Keyless  
**Wattage:** 60 B

**Designer:**  
AERIN

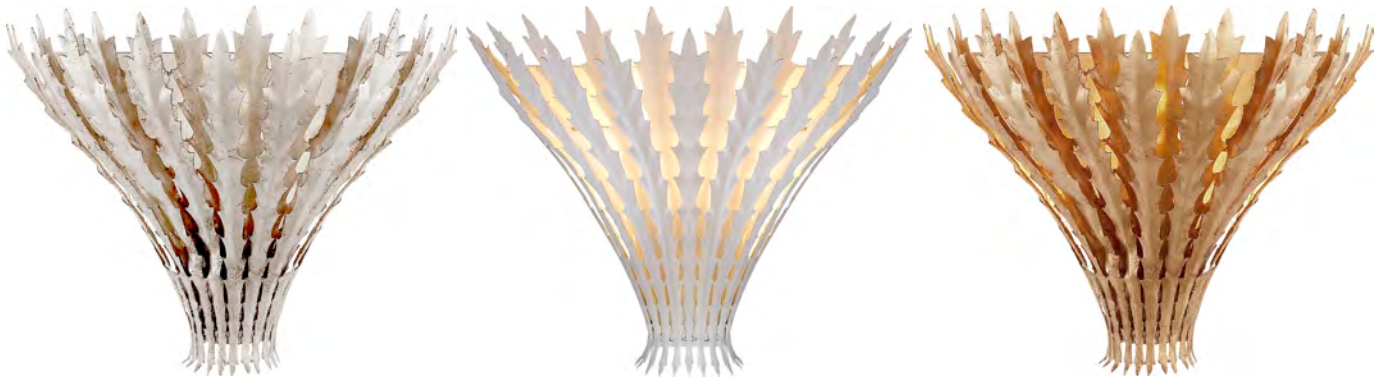

**ARN2000BSL-WG**  
**Edgemere Wall Light**  
**in Burnished Silver**  
**Leaf with White Glass**  
Height: 16"  
Width: 4.5"  
Extension: 8.5"  
Backplate: 4.25" Round

**ARN2000G-WG**

**ARN2000BZ-WG**

**Finishes:**  
BSL, BZ, G, PW  
**Glass Options:** WG

**Socket:** Candelabra  
**Wattage:** 60 B

**Designer:**  
AERIN



**BBL2080CW-S**  
**Go Lightly Sconce**  
**in China White**  
**with Silk Shade**  
 Height: 17"  
 Width: 6.75"  
 Extension: 7"  
 Backplate: 4.25" Round

**Finishes:** C, CW, G  
**Shade Treatments:** S  
**Shade Details:**  
 6" x 6.75" x 7.5"

**Socket:** Candelabra  
**Wattage:** 40 B

**Designer:**  
 Barbara Barry

BBL2080G-S

BBL2080C-S



**ARN2022BSL-L**  
**Bristol Single Sconce**  
**in Burnished Silver**  
**Leaf with Linen Shade**  
 Height: 18"  
 Width: 6.5"  
 Extension: 7"  
 Backplate: 4.5" Round

**Finishes:** AI, BSL, G  
**Shade Treatments:** L  
**Shade Details:**  
 5" x 7" x 6.5" Nordy

**Socket:** Candelabra  
**Wattage:** 40 B

**Designer:**  
 AERIN

ARN2022G-L

ARN2022AI-L



**ARN2051BSL-L**  
**Montreuil Small**  
**Wall Sconce in**  
**Burnished Silver Leaf**  
**with Linen Shades**  
Height: 22"  
Width: 16.5"  
Extension: 11.25"  
Backplate: 4.25" Round

**Finishes:** BSL, G  
**Shade Treatments:** L  
**Shade Details:**  
2.5" x 5" x 7"

**Socket:**  
3 - Candelabra  
**Wattage:** 3 - 40 B

**Designer:**  
AERIN

ARN2051G-L



**ARN2052BSL-L**  
**Montreuil Medium**  
**Wall Sconce in**  
**Burnished Silver Leaf**  
**with Linen Shades**  
Height: 17.5"  
Width: 29.25"  
Extension: 17.25"  
Backplate: 4.25" Round

**Finishes:** BSL, G  
**Shade Treatments:** L  
**Shade Details:**  
2.5" x 5" x 7"

**Socket:**  
5 - Candelabra  
**Wattage:** 5 - 40 B

**Designer:**  
AERIN



**CHD1495GI-NP**  
**Flemish Single Sconce**  
in Gilded Iron with  
Natural Paper Shade  
Height: 15.25"  
Width: 6.5"  
Extension: 11.75"  
Backplate:  
4" x 6.5" Rectangle

**Finishes:** AI, GI  
**Shade Treatments:** NP  
**Shade Details:**  
4.5" x 6" x 5.5"

**Socket:** Candelabra  
**Wattage:** 60 B

**Designer:**  
E. F. Chapman

©EFC DESIGNS

CHD1495AI-NP



**CHD1496GI-NP**  
**Flemish Double Sconce**  
in Gilded Iron with  
Natural Paper Shades  
Height: 15"  
Width: 12.5"  
Extension: 11.75"  
Backplate:  
4" x 6.5" Rectangle

**Finishes:** AI, GI  
**Shade Treatments:**  
NP  
**Shade Details:**  
4.5" x 6" x 5.5"

**Socket:**  
2 - Candelabra  
**Wattage:** 2 - 60 B

**Designer:**  
E. F. Chapman

©EFC DESIGNS

CHD1496AI-NP





**CHD1158GI**  
**Perching Bird Sconce**  
**in Gilded Iron**

Height: 14"  
Width: 5"  
Extension: 7"  
Backplate:  
6.75" x 4.75" Oval

**Finishes:** GI, R

**Socket:** Candelabra  
**Wattage:** 60 C

**Note:**  
CHS104B Shade  
Sold Separately

**Designer:**  
E. F. Chapman

©EFC DESIGNS



CHD1158R



**SK2105GI**  
**Margarite Single**  
**Sconce in Gilded Iron**

Height: 21"  
Width: 4.75"  
Extension: 7"  
Backplate:  
4.75" x 10.75" Rectangle

**Finishes:** AI, GI

**Socket:** Candelabra  
**Wattage:** 60 C

**Note:**  
CHS104NP Shade  
Sold Separately/Use  
40 Watt Frosted  
Type "B" with Clip  
On Shade

**Designer:**  
Suzanne Kasler



SK2105AI



**SK4000GI**  
**Ré Flush Mount**  
**in Gilded Iron**  
Height: 22"  
Width: 22"  
Extension: 6"  
Canopy: 5" Round

**Finishes:** GI

**Socket:**  
2 - Candelabra  
**Wattage:** 2 - 60 B

**Designer:**  
Suzanne Kasler



**CHD1625BSL**  
**Claymore Sconce in**  
**Burnished Silver Leaf**  
Height: 25"  
Width: 8.25"  
Extension: 5"  
Backplate: 4.25" Round

**Finishes:** BSL, GI

**Socket:** 2 - Candelabra  
**Wattage:** 2 - 60 C

**Designer:**  
E. F. Chapman

©EFC DESIGNS



**CHD1625GI**



**CHD1627BSL**  
**Claymore Tall Sconce in**  
**Burnished Silver Leaf**  
Height: 38.5"  
Width: 10.5"  
Extension: 4"  
Backplate: 4.25" Round

**Finishes:** BSL, GI

**Socket:** 2 - Candelabra  
**Wattage:** 2 - 40 C

**Designer:**  
E. F. Chapman

©EFC DESIGNS



**CHD1627GI**



**CHD1125OW**  
**Marlborough Single Sconce in Old White**  
Height: 12.5"  
Width: 7.5"  
Extension: 5"  
Backplate: 4.25" Round

CHD1125GI

**Finishes:** GI, OW

**Socket:** Candelabra  
**Wattage:** 60 B

**Note:**  
CHS104NP Sold Separately/Use 40 Watt Frosted Type "B" with Clip On Shade

**Designer:**  
E. F. Chapman

©EFC DESIGNS



**CHD1126OW**  
**Marlborough Double Sconce in Old White**  
Height: 12.5"  
Width: 7.5"  
Extension: 5"  
Backplate: 4.25" Round

CHD1126GI

**Finishes:** GI, OW

**Socket:**  
2 - Candelabra  
**Wattage:** 2 - 60 B

**Note:**  
CHS104NP Sold Separately/Use 40 Watt Frosted Type "B" with Clip On Shade

**Designer:**  
E. F. Chapman

©EFC DESIGNS



**S2120GI-NP**  
**Bristol Small Sconce**  
**in Gilded Iron with**  
**Natural Paper Shades**

Height: 15.5"  
Width: 7.5"  
Extension: 4.5"  
Backplate:  
3" x 4" Rectangle

**Finishes:** AI, GI  
**Shade Treatments:** NP  
**Shade Details:**  
2.5" x 3.5" x 4"

**Socket:**  
2 - Candelabra  
**Wattage:** 2 - 40 B

**Designer:**  
Studio VC



S2120AI-NP



**S2121GI-NP**  
**Bristol Large Sconce**  
**in Gilded Iron with**  
**Natural Paper Shade**

Height: 24.5"  
Width: 11.5"  
Extension: 6.5"  
Backplate:  
4" x 6.75" Rectangle

**Finishes:** AI, GI  
**Shade Treatments:**  
NP  
**Shade Details:**  
10.5" x 11.5" x 6"  
Rectangle

**Socket:**  
2 - Candelabra  
**Wattage:** 2 - 40 B

**Designer:**  
Studio VC



S2121AI-NP



**S2107NI**  
**Kassel Single Sconce**  
**in Natural Iron**  
 Height: 10.5"  
 Width: 4.25"  
 Extension: 6.75"  
 Backplate: 4.25" Square

**Finishes:** NI

**Socket:** Candelabra  
**Wattage:** 60 B

**Designer:**  
 Studio VC



**S2108NI-NP**  
**Kassel Double Sconce**  
**in Natural Iron with**  
**Natural Paper Shade**  
 Height: 10.5"  
 Width: 15.5"  
 Extension: 7.5"  
 Backplate: 4.25" Square

**Finishes:** NI  
**Shade Treatments:**  
 NP

**Shade Details:**  
 15" x 15.5" x 5.5"  
 Rectangle

**Socket:**  
 2 - Candelabra  
**Wattage:** 2 - 60 B

**Designer:**  
 Studio VC



**SK2258GI-PL**  
**Heart Sconce in**  
**Gilded Iron with**  
**Natural Percale Shade**  
 Height: 19"  
 Width: 12.75"  
 Extension: 4.25"  
 Backplate: 4" Square

**Finishes:** AI, GI  
**Shade Treatments:**  
 PL

**Shade Details:**  
 12.25" x 12.75" x 9"  
 Rectangle Shield

**Socket:** Keyless  
**Wattage:** 60 B

**Designer:**  
 Suzanne Kasler



**SK2258AI-PL**



**CHD1404GI-NP**  
**Iron Torch Sconce**  
**in Gilded Iron with**  
**Natural Paper Shade**

Height: 18"  
Width: 8"  
Extension: 9"  
Backplate: 5.5" Round

**Finishes:** BR, GI  
**Shade Treatments:** NP  
**Shade Details:**  
5" x 8" x 6"

**Socket:** Keyless  
**Wattage:** 60 B

**Designer:**  
E. F. Chapman

©EFC DESIGNS



**CHD1404BR-NP**



**CHD1407GI-NP**  
**Long Iron Torch in**  
**Gilded Iron with**  
**Natural Paper Shade**

Height: 36"  
Width: 13.5"  
Extension: 6.25"  
Backplate: 4.25" Round

**Finishes:** BR, GI  
**Shade Treatments:** NP  
**Shade Details:**  
10.5" x 13.5" x 8.5"

**Socket:** Keyless  
**Wattage:** 60 A

**Designer:**  
E. F. Chapman

©EFC DESIGNS



**CHD1407BR-NP**



**SK2009BW-NP**  
**Roswell Sconce in Belgian White with Natural Paper Shade**  
 Height: 27"  
 Width: 11"  
 Extension: 7.5"  
 Backplate: 4.5" Round

**Finishes:**  
 BW, GI, NR  
**Shade Treatments:**  
 BL, L, NP, TL  
**Shade Details:**  
 11" x 11" x 8.75"

**Socket:**  
 2 - Keyless  
**Wattage:** 2 - 60 B

**Designer:**  
 Suzanne Kasler

SK2009GI-NP

SK2009NR-BL



**CHD1388GI-NP**  
**Emilia Sconce in Gilded Iron with Natural Paper Shade**  
 Height: 22.75"  
 Width: 14"  
 Extension: 6.5"  
 Backplate: 4.25" Round

**Finishes:**  
 AI, GI, RW  
**Shade Treatments:**  
 NP  
**Shade Details:**  
 13" x 14" x 8.5"  
 Shield

**Socket:** Keyless  
**Wattage:** 75 A

**Designer:**  
 E. F. Chapman

©EFC DESIGNS

CHD1388AI-NP





**SK2501GI-L**  
**Quatrefoil Tail**  
**Sconce in Gilded Iron**  
**with Linen Shade**  
Height: 32.5"  
Width: 14.5"  
Extension: 4.75"  
Backplate:  
4.5" x 6" Rectangle

**Finishes:** AI, GI  
**Shade Treatments:** L  
**Shade Details:**  
14.5" x 14.5" x 9.75"  
Shield

**Socket:** Keyless  
**Wattage:** 60 A

**Designer:**  
Suzanne Kasler



**SK2501AI-L**



**SK2263GI-L**  
**Carey Rail Sconce**  
**in Gilded Iron**  
**with Linen Shade**  
Height: 31"  
Width: 14.5"  
Extension: 5.25"  
Backplate:  
4" x 6" Rectangle

**Finishes:** AI, GI  
**Shade Treatments:** L  
**Shade Details:**  
14.5" x 14.5" x 9.5"  
Shield

**Socket:** Keyless  
**Wattage:** 100 A

**Designer:**  
Suzanne Kasler



**SK2263AI-L**





**CHD2300PN-NP**  
**Cawdor Stanchion**  
**Wall Light in Polished**  
**Nickel with Natural**  
**Paper Shade**  
Height: 35.75"  
Width: 12.5"  
Extension: 7"  
Backplate: 4.25" Round

**Finishes:**  
AB, AI, GI, PN  
**Shade Treatments:** NP  
**Shade Details:**  
11.75" x 12.5" x 8.25"  
Shield

**Socket:** Keyless  
**Wattage:** 75 A

**Designer:**  
E. F. Chapman

©EFC DESIGNS



**CHD2300AB-NP**



**CHD2300GI-NP**



**CHD2300AI-NP**



**S2401GI-NP**  
**Dauphine Sconce**  
 in Gilded Iron with  
 Natural Paper Shade  
 Height: 19"  
 Width: 5.5"  
 Extension: 4.5"  
 Backplate: 4" Square

**Finishes:** AI, GI  
**Shade Treatments:** NP  
**Shade Details:**  
 5" x 5.5" x 6.5"  
 Shield

**Socket:** Candelabra  
**Wattage:** 40 B

**Note:** Requires a  
 Smaller Outlet Box

**Designer:**  
 Studio VC



**S2401AI-NP**



**CHD2705GI-NP**  
**Strie Wall Sconce**  
 in Gilded Iron with  
 Natural Paper Shade  
 Height: 25.5"  
 Width: 11.25"  
 Extension: 5.25"  
 Backplate:  
 4.25" Round

**Finishes:** AI, GI  
**Shade Treatments:** NP  
**Shade Details:**  
 10.5" x 11.25" x 7"  
 Rectangle Shield

**Socket:** Candelabra  
**Wattage:** 60 C

**Designer:**  
 E. F. Chapman

©EFC DESIGNS



**CHD2705AI-NP**



**S2406GI-NP**  
**Cranston Small Sconce**  
**in Gilded Iron with**  
**Natural Paper Shade**

Height: 16.25"  
Width: 6.5"  
Extension: 4.25"  
Backplate: 4" Round

**Finishes:** AI, GI  
**Shade Treatments:** NP  
**Shade Details:**  
6" x 6.5" x 5.25"  
Oval Shield

**Socket:** Candelabra  
**Wattage:** 40 B

**Designer:**  
Studio VC



S2406AI-NP



**S2408GI-NP**  
**Cranston Large**  
**Sconce in Gilded Iron**  
**with Natural**  
**Paper Shade**

Height: 37"  
Width: 13"  
Extension: 4.75"  
Backplate: 4" Round

**Finishes:** AI, GI  
**Shade Treatments:** NP  
**Shade Details:**  
11" x 13" x 9.5"  
Oval Shield

**Socket:** Keyless  
**Wattage:** 75 A

**Designer:**  
Studio VC



S2408AI-NP

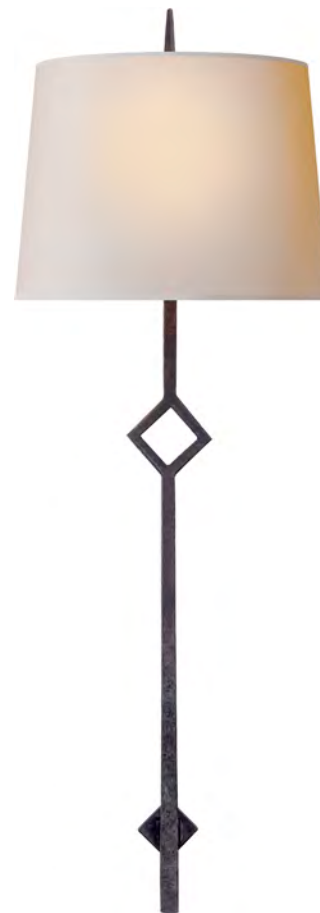

**SK2000NR/OW**  
**Percival Sconce in**  
**Natural Rust and**  
**Gild White**  
Height: 21"  
Width: 16.75"  
Extension: 8"  
Backplate:  
4.25" x 5" Rectangle

**Finishes:** NR/OW

**Socket:**  
2 - Candelabra  
**Wattage:** 2 - 60 C

**Designer:**  
Suzanne Kasler



**TOB2217BW-NP**  
**Aldo Railing Sconce**  
in Belgian White with  
Natural Paper Shade  
Height: 27"  
Width: 8.75"  
Extension: 7.5"  
Backplate: 4" Square

**Finishes:** BW, DG  
**Shade Treatments:** NP  
**Shade Details:**  
8" x 8.75" x 8"  
Shield

**Socket:**  
2 - Candelabra  
**Wattage:** 2 - 60 B

**Designer:**  
Thomas O'Brien



**TOB2217DG-NP**



**TOB2220HAB-NP**  
**Verona Railing Sconce**  
in Hand-Rubbed  
Antique Brass with  
Natural Paper Shade  
Height: 35.75"  
Width: 12.75"  
Extension: 9.5"  
Backplate: 4" Square

**Finishes:** HAB, WI  
**Shade Treatments:** NP  
**Shade Details:**  
12.75" x 12.75" x 10"  
Shield

**Socket:** 2 - Keyless  
**Wattage:** 2 - 60 B

**Designer:**  
Thomas O'Brien



**TOB2220WI-NP**



**S2052GI-NP**  
**Vail Sconce in Gilded Iron with Natural Paper Shade**  
 Height: 19.75"  
 Width: 6.25"  
 Extension: 3.5"  
 Backplate: 4.75" Square

**Finishes:** AI, GI  
**Shade Treatments:** NP  
**Shade Details:**  
 6.25" x 6.25" x 7"

**Socket:** Keyless  
**Wattage:** 40 B

**Designer:**  
 Ian Fowler



**S2052AI-NP**



**S2050GI-NP**  
**Aspen Sconce in Gilded Iron with Natural Paper Shade**  
 Height: 18.5"  
 Width: 9"  
 Extension: 4.5"  
 Backplate: 5" Round

**Finishes:** BR, GI  
**Shade Treatments:** NP  
**Shade Details:**  
 9" x 9" x 5.5"

**Socket:** Candelabra  
**Wattage:** 60 B

**Designer:**  
 Studio VC



**S2050BR-NP**





**S2030BR-NP**  
**Aspen Iron Wall Lamp**  
in Black Rust with  
**Natural Paper Shade**  
Height: 15.5"  
Width: 7.5"  
Extension: 9.5"  
Backplate:  
5" x 12.75" Rectangle

**Finishes:** BR  
**Shade Treatments:** NP  
**Shade Details:**  
7.5" x 7.5" x 6"

**Socket:** Candelabra  
**Wattage:** 60 B

**Designer:**  
Studio VC



**SC2200PN-NP**  
**Puzzle Sconce in Polished Nickel with Natural Paper Shade**  
 Height: 16.75"  
 Width: 5"  
 Extension: 10.25"  
 Backplate: 5" Square

**Finishes:**  
 BZ, HAB, PN  
**Shade Treatments:** NP  
**Shade Details:**  
 4.5" x 4.5" x 4.5"

**Socket:** Candelabra  
**Wattage:** 60 B

**Designer:**  
 Eric Cohler



SC2200HAB-NP



**S2090PN-NP**  
**Cooper Sconce in Polished Nickel with Natural Paper Shade**  
 Height: 21"  
 Width: 9"  
 Extension: 4"  
 Backplate:  
 4.25" Square

**Finishes:**  
 BZ, HAB, PN  
**Shade Treatments:**  
 NP  
**Shade Details:**  
 9" x 9" x 9.5"  
 Rectangle

**Socket:** Candelabra  
**Wattage:** 60 B

**Designer:**  
 Studio VC



S2090HAB-NP





**SR2000PN**  
**Miguel Double**  
**Sconce in**  
**Polished Nickel**  
 Height: 10.5"  
 Width: 9"  
 Extension: 4.25"  
 Backplate: 7" x 8"

**Finishes:**  
 HAB, PN, SN

**Socket:**  
 2 - Candelabra  
**Wattage:** 2 - 60 C

**Designer:**  
 John Rosselli



SR2000HAB



**SR2140SHS**  
**Savannah Sconce**  
**in Sheffield Nickel**  
 Height: 16"  
 Width: 5"  
 Extension: 5.75"  
 Backplate:  
 5" x 16" Rectangle

**Finishes:** HAB, SHS

**Socket:**  
 Candelabra  
**Wattage:** 60 B

**Designer:**  
 John Rosselli



SR2140HAB



**SC2105PN**  
**Double Twist**  
**Two-Light Sconce in**  
**Polished Nickel**  
 Height: 11.25"  
 Width: 18.5"  
 Extension: 4.5"  
 Backplate: 4.5" Square

**Finishes:**  
 AS, BZ, HAB, PN

**Socket:** 2 - Candelabra  
**Wattage:** 2 - 60 C

**Designer:**  
 Eric Cohler



SC2105HAB



**SC2160PN-NP**  
**Catherine Wall**  
**Sconce in Polished**  
**Nickel with Natural**  
**Paper Shades**  
 Height: 22"  
 Width: 13"  
 Extension: 7.75"  
 Backplate:  
 3" x 5.25"

**Finishes:**  
 BZ, HAB, PN  
**Shade Treatments:**  
 NP  
**Shade Details:**  
 4.5" x 4.5" x 5.75"

**Socket:**  
 2 - Candelabra  
**Wattage:** 2 - 60 B

**Note:** Requires a  
 Smaller Outlet Box

**Designer:**  
 Eric Cohler

SC2160HAB-NP





**CHD2460PN-NP**  
**Ruhlmann Single**  
**Sconce in Polished**  
**Nickel with Natural**  
**Paper Shade**  
Height: 22.5"  
Width: 6.25"  
Extension: 7"  
Backplate: 3.5" x 6.25"

**Finishes:**  
AB, AN, BZ, PN  
**Shade Treatments:** NP  
**Shade Details:**  
5.5" x 6.25" x 6"  
Shield

**Socket:** Candelabra  
**Wattage:** 40 B

**Note:** Requires a  
Smaller Outlet Box

**Designer:**  
E. F. Chapman

©EFC DESIGNS

CHD2460AN-NP



CHD2460AB-NP



CHD2460BZ-NP



**CHD2461PN-NP**  
**Ruhlmann Double Sconce in Polished Nickel with Natural Paper Shade**  
Height: 22.5"  
Width: 10.75"  
Extension: 6.25"  
Backplate: 3.5" x 6.25"

**Finishes:**  
AB, AN, BZ, PN  
**Shade Treatments:**  
NP  
**Shade Details:**  
10.5" x 10.75" x 6"

**Socket:**  
2 - Candelabra  
**Wattage:** 2 - 40 B

**Note:** Requires a Smaller Outlet Box

**Designer:**  
E. F. Chapman

©EFC DESIGNS

CHD2461AN-NP



CHD2461AB-NP



CHD2461BZ-NP





**TOB2600HAB-NP**  
**Silhouette Fretwork**  
**Sconce in Hand-Rubbed**  
**Antique Brass with**  
**Natural Paper Shade**  
Height: 16.5"  
Width: 8.75"  
Extension: 4.5"  
Backplate: 4.5" x 8"

**Finishes:**  
BZ, HAB, PN  
**Shade Treatments:** NP  
**Shade Details:**  
8.5" x 8.75" x 6.5"

**Socket:**  
2 - Candelabra  
**Wattage:** 2 - 25 B

**Designer:**  
Thomas O'Brien





**S2020PN-L**  
French Deco Horn  
Sconce in  
Polished Nickel  
with Linen Shade  
Height: 23.5"  
Width: 5"  
Extension: 7"  
Backplate:  
3.25" x 7" Rectangle

**Finishes:**  
AN, BZ, HAB, PN  
**Shade Treatments:** L  
**Shade Details:**  
5" x 5" x 6"

**Socket:** Candelabra  
**Wattage:** 40 B

**Note:** Requires a  
Smaller Outlet Box

**Designer:**  
Studio VC

S2020AN-L



S2020HAB-L



**S2021HAB-L**  
French Deco Horn  
Double Sconce  
in Hand-Rubbed  
Antique Brass  
with Linen Shades  
Height: 22"  
Width: 12.25"  
Extension: 6"  
Backplate:  
3.25" x 7" Rectangle

**Finishes:**  
AN, BZ, HAB, PN  
**Shade Treatments:**  
L, NP  
**Shade Details:**  
5" x 5" x 6"

**Socket:**  
2 - Candelabra  
**Wattage:** 2 - 40 B

**Note:** Requires a  
Smaller Outlet Box

**Designer:**  
Studio VC

S2021BZ-L



**SL2860PN**  
**TT Single Sconce**  
**in Polished Nickel**  
 Height: 18"  
 Width: 4"  
 Extension: 7"  
 Backplate:  
 4" x 6" Rectangle

**Finishes:**  
 AN, BZ, HAB, PN

**Socket:** Candelabra  
**Wattage:** 60 C

**Note:**  
 CHS104NP Shade  
 Sold Separately/Use  
 40 Watt Frosted  
 Type "B" with  
 Clip On Shade

**Designer:**  
 E. F. Chapman

©EFC DESIGNS

SL2860HAB



SL2860BZ



**SL2861PN**  
**TT Double Sconce**  
**in Polished Nickel**  
 Height: 18"  
 Width: 10"  
 Extension: 7"  
 Backplate:  
 4" x 6" Rectangle

**Finishes:**  
 AN, BZ, HAB, PN

**Socket:**  
 2 - Candelabra  
**Wattage:** 2 - 60 C

**Note:**  
 CHS104NP Shade  
 Sold Separately/Use  
 40 Watt Frosted  
 Type "B" with  
 Clip On Shade

**Designer:**  
 E. F. Chapman

©EFC DESIGNS

SL2861BZ



**SL2865AN**  
**Right Angle**  
**Single Sconce in**  
**Antique Nickel**  
 Height: 18"  
 Width: 4"  
 Extension: 7"  
 Backplate:  
 4" x 6" Rectangle

**Finishes:**  
 AN, BZ, HAB, PN

**Socket:** Candelabra  
**Wattage:** 60 C

**Note:**  
 CHS104NP Shade  
 Sold Separately/Use  
 40 Watt Frosted  
 Type "B" with  
 Clip On Shade

**Designer:**  
 E. F. Chapman

©EFC DESIGNS

SL2865HAB



SL2865BZ



**SL2866PN**  
**Right Angle**  
**Double Sconce in**  
**Polished Nickel**  
 Height: 18"  
 Width: 10"  
 Extension: 7"  
 Backplate:  
 4" x 6" Rectangle

**Finishes:**  
 AN, BZ, HAB, PN

**Socket:**  
 2 - Candelabra  
**Wattage:** 2 - 60 C

**Note:**  
 CHS104NP Shade  
 Sold Separately/Use  
 40 Watt Frosted  
 Type "B" with  
 Clip On Shade

**Designer:**  
 E. F. Chapman

©EFC DESIGNS

SL2866HAB



**SK2250AB-L**  
**Lana Double Sconce**  
 in Antique-Burnished  
 Brass with  
 Linen Shade  
 Height: 18"  
 Width: 9.25"  
 Extension: 4.75"  
 Backplate: 4" Square

**Finishes:**  
 AB, BZ, PN, SN  
**Shade Treatments:** L  
**Shade Details:**  
 8.25" x 9.25" x 6.25"  
 Rectangle Shield

**Socket:** 2 - Keyless  
**Wattage:** 2 - 60 B

**Designer:**  
 Suzanne Kasler



**SK2250BZ-L**



**SK2251AB-L**  
**Lana Tail Sconce**  
 in Antique-Burnished  
 Brass with  
 Linen Shade  
 Height: 29.75"  
 Width: 12"  
 Extension: 5"  
 Backplate: 4" Square

**Finishes:**  
 AB, BZ, PN, SN  
**Shade Treatments:** L  
**Shade Details:**  
 10.75" x 12" x 7"  
 Rectangle Shield

**Socket:** 2 - Keyless  
**Wattage:** 2 - 60 B

**Designer:**  
 Suzanne Kasler



**SK2251BZ-L**



**CHD1610PN-NP**  
**Symmetric Twist**  
**Single Sconce in**  
**Polished Nickel with**  
**Natural Paper Shade**  
 Height: 16"  
 Width: 5"  
 Extension: 5.25"  
 Backplate: 4.5" Round

**Finishes:**  
 AB, AN, BZ, PN  
**Shade Treatments:** NP  
**Shade Details:**  
 3.5" x 5" x 4.5"

**Socket:** Candelabra  
**Wattage:** 40 B

**Designer:**  
 E. F. Chapman

©EFC DESIGNS

CHD1610AB-NP



CHD1610BZ-NP



**CHD1612AN-NP**  
**Symmetric Twist**  
**Double Sconce in**  
**Antique Nickel with**  
**Natural Paper Shade**  
 Height: 20"  
 Width: 13.5"  
 Extension: 6.75"  
 Backplate: 4.5" Round

**Finishes:**  
 AB, AN, BZ, PN  
**Shade Treatments:** NP  
**Shade Details:**  
 13" x 13.5" x 5.25"

**Socket:**  
 2 - Candelabra  
**Wattage:** 2 - 60 B

**Designer:**  
 E. F. Chapman

©EFC DESIGNS

CHD1612AB-NP







**CHD2970ALB-NP**  
**Ring Form**  
**Large Wall Sconce**  
**in Alabaster with**  
**Natural Paper Shade**  
Height: 19"  
Width: 13.5"  
Extension: 7"  
Backplate: 4.25" x 6.5"  
Rectangle

**Finishes:**  
AB, ALB, BZ, G, PN  
**Shade Treatments:**  
NP  
**Shade Details:**  
10.5" x 13.5" x 8.5"

**Socket:** Hi-Lo  
**Wattage:** 75 A

**Designer:**  
E. F. Chapman

©EFC DESIGNS

CHD2970AB-NP



CHD2970G-NP



CHD2970PN-NP



**CHD2540PN-NP**  
**Symbolic Fragment**  
**Wall Sconce in**  
**Polished Nickel with**  
**Natural Paper Shade**  
 Height: 17"  
 Width: 13.5"  
 Extension: 8.5"  
 Backplate: 4.25" Round

**Finishes:**  
 AB, BZ, PN  
**Shade Treatments:**  
 NP  
**Shade Details:**  
 10.5" x 13.5" x 8.5"

**Socket:** Keyless  
**Wattage:** 75 A

**Designer:**  
 E. F. Chapman

©EFC DESIGNS



**CHD2540AB-NP**



**CHD2266PN-NP**  
**Modern Darlana**  
**Bouillotte Sconce in**  
**Polished Nickel with**  
**Natural Paper Shade**  
 Height: 22.5"  
 Width: 12.5"  
 Extension: 6.5"  
 Backplate: 4" Square

**Finishes:**  
 AB, BZ, PN  
**Shade Treatments:**  
 NP  
**Shade Details:**  
 12" x 12.5" x 7"  
 Shield

**Socket:**  
 2 - Candelabra  
**Wattage:** 2 - 40 C

**Designer:**  
 E. F. Chapman

©EFC DESIGNS

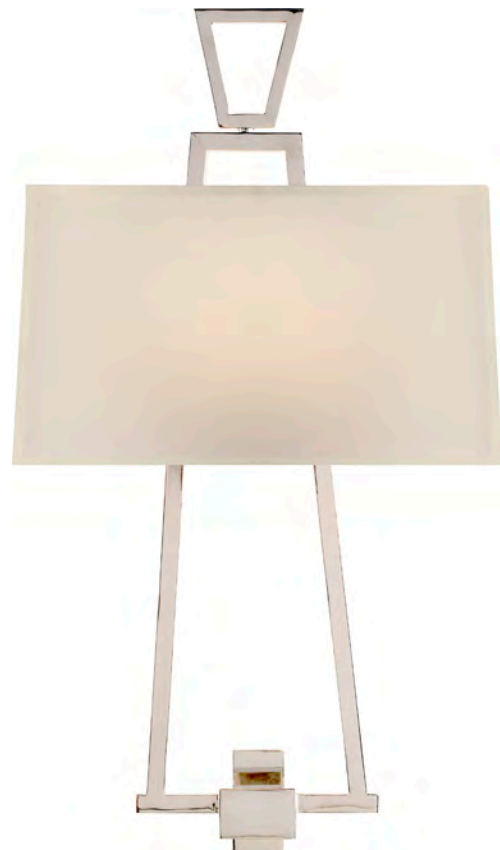

**CHD2266AB-NP**



**CHD1190PN-NP**  
**Cross Bouillotte Small**  
**Sconce in Polished**  
**Nickel with Natural**  
**Paper Shade**  
Height: 12.5"  
Width: 10"  
Extension: 4.5"  
Backplate:  
2.25" x 4.5" Rectangle

**CHD1190AB-NP**

**CHD1190BZ-NP**

**Finishes:**  
AB, AN, BZ, PN  
**Shade Treatments:**  
NP  
**Shade Details:**  
9" x 10" x 5"

**Socket:**  
2 - Candelabra  
**Wattage:** 2 - 40 B

**Note:** Requires a  
Smaller Outlet Box

**Designer:**  
E. F. Chapman

©EFC DESIGNS



**CHD1191PN-NP**  
**Cross Bouillotte Large**  
**Sconce in Polished**  
**Nickel with Natural**  
**Paper Shade**  
Height: 14.75"  
Width: 15"  
Extension: 6"  
Backplate: 4.25" Round

**CHD1191AB-NP**

**Finishes:**  
AB, AN, BZ, PN  
**Shade Treatments:**  
NP  
**Shade Details:**  
14" x 15" x 5.25"

**Socket:**  
2 - Candelabra  
**Wattage:** 2 - 40 B

**Designer:**  
E. F. Chapman

©EFC DESIGNS





**BBL2035PN-S**  
**French Cuff Sconce**  
**in Polished Nickel**  
**with Silk Shade**  
Height: 14"  
Width: 8"  
Extension: 8.75"  
Backplate: 4.75" Round

**Finishes:**  
BZ, PN, SB, SS  
**Shade Treatments:** S  
**Shade Details:**  
7.5" x 8" x 8.5"

**Socket:** Keyless  
**Wattage:** 75 A

**Designer:**  
Barbara Barry

**BBL2035SS-S**



**BBL2035SB-S**



**BBL2035BZ-S**



**BBL2038SS-S**  
**Graceful Ribbon**  
**Single Sconce in Soft**  
**Silver with Silk Shade**

Height: 13"  
 Width: 6.75"  
 Extension: 8.25"  
 Backplate:  
 3.75" x 6.75" Oval

**Finishes:**  
 BZ, PWT, SB, SS  
**Shade Treatments:**  
 S

**Shade Details:**  
 6.5" x 6.75" x 7"

**Socket:** Keyless  
**Wattage:** 75 A

**Note:** Requires a  
 Smaller Outlet Box

**Designer:**  
 Barbara Barry

BBL2038SB-S

BBL2038BZ-S



**BBL2039SS-S**  
**Graceful Ribbon**  
**Double Sconce in**  
**Soft Silver with**  
**Silk Shade**

Height: 13"  
 Width: 12.5"  
 Extension: 7.5"  
 Backplate:  
 3.75" x 6.75" Oval

**Finishes:**  
 BZ, PWT, SB, SS  
**Shade Treatments:** S  
**Shade Details:**  
 12.5" x 12.5" x 8"  
 Oval

**Socket:** 2 - Keyless  
**Wattage:** 2 - 60 A

**Note:** Requires a  
 Smaller Outlet Box

**Designer:**  
 Barbara Barry

BBL2039SB-S



**TOB2380PN-NP**  
**Bijon Sconce in**  
**Polished Nickel with**  
**Natural Paper Shade**  
Height: 13.75"  
Width: 4.5"  
Extension: 5.5"  
Backplate: 4" Round

**Finishes:**  
BZ, CG, HAB, PN  
**Shade Treatments:**  
NP  
**Shade Details:**  
4.5" x 4.5" x 9.25"

**Socket:** Keyless  
**Wattage:** 40 B

**Designer:**  
Thomas O'Brien

**TOB2380HAB-NP**



**TOB2380BZ-NP**



**SS2031PN-NP**  
**Box Sconce in**  
**Polished Nickel with**  
**Natural Paper Shade**  
Height: 11"  
Width: 7.5"  
Extension: 7.25"  
Backplate: 4.5" x 11" Rectangle

**Finishes:**  
BZ, HAB, PN  
**Shade Treatments:** NP  
**Shade Details:**  
7.5" x 7.5" x 6.5"

**Socket:** Keyless  
**Wattage:** 60 A

**Note:** Cord  
Cover Included

**Designer:**  
Studio VC

**SS2031BZ-NP**



**TOB2128PN-S**  
**Germain Single**  
**Sconce in Polished**  
**Nickel with Silk**  
**Pleated Shade**  
 Height: 12.25"  
 Width: 3.75"  
 Extension: 6.5"  
 Backplate:  
 3.75" x 5" Rectangle

**Finishes:**  
 BZ/HAB, HAB, PN  
**Shade Treatments:** S  
**Shade Details:**  
 3.75" x 3.75" x 7"

**Socket:**  
 Candelabra  
**Wattage:** 40 B

**Designer:**  
 Thomas O'Brien

TOB2128HAB-S



TOB2128BZ/HAB-S



**TOB2131PN-S**  
**Germain Large**  
**Single Sconce in**  
**Polished Nickel with**  
**Silk Pleated Shade**  
 Height: 14.5"  
 Width: 7.25"  
 Extension: 4"  
 Backplate:  
 3.75" x 5" Rectangle

**Finishes:**  
 BZ/HAB, HAB, PN  
**Shade Treatments:**  
 S  
**Shade Details:**  
 7.25" x 7.25" x 8.25"

**Socket:**  
 Candelabra  
**Wattage:** 40 B

**Designer:**  
 Thomas O'Brien

TOB2131HAB-S



TOB2131BZ/HAB-S







**SL2820BZ-NP**  
**Square Tube Double**  
**Sconce in Bronze with**  
**Natural Paper Shade**  
Height: 14"  
Width: 15.5"  
Extension: 7.25"  
Backplate:  
4" x 4.5" Rectangle

**Finishes:**  
AN, BZ, HAB, PN  
**Shade Treatments:** NP  
**Shade Details:**  
4.5" x 6.25" x 6.25"

**Socket:**  
2 - Candelabra  
**Wattage:** 2 - 60 B

**Designer:**  
E.F. Chapman

©EFC DESIGNS



**SL2819PN-NP**  
**Square Tube Single Sconce in Polished Nickel with Natural Paper Shade**  
Height: 14.25"  
Width: 6.25"  
Extension: 7.5"  
Backplate: 4" x 4.5" Rectangle

**Finishes:** AN, BZ, HAB, PN  
**Shade Treatments:** NP  
**Shade Details:** 4.5" x 6.25" x 6.25"

**Socket:** Candelabra  
**Wattage:** 60 B

**Designer:** E. F. Chapman

©EFC DESIGNS

SL2819HAB-NP



SL2819BZ-NP



**SL2820PN-NP2**  
**Square Tube Double Sconce in Polished Nickel with Natural Paper Single Shade**  
Height: 14"  
Width: 15.5"  
Extension: 7.25"  
Backplate: 4" x 4.5" Rectangle

**Finishes:** AN, BZ, HAB, PN  
**Shade Treatments:** NP  
**Shade Details:** 13.75" x 15.5" x 6.25"

**Socket:** 2 - Candelabra  
**Wattage:** 2 - 60 B

**Designer:** E. F. Chapman

©EFC DESIGNS

SL2820BZ-NP2



**ARN2004PN-L**  
**Union Single**  
**Arm Sconce in**  
**Polished Nickel**  
**with Linen Shade**

Height: 12"  
 Width: 7"  
 Extension: 10.75"  
 Backplate:  
 5.25" Square

**Finishes:**  
 BZ, HAB, PN  
**Shade Treatments:**  
 L, WG  
**Shade Details:**  
 5" x 7" x 5.5"

**Socket:**  
 Candelabra  
**Wattage:** 60 B

**Designer:**  
 AERIN

ARN2004HAB-L

ARN2004BZ-L



**ARN2005PN-L**  
**Union Double**  
**Arm Sconce in**  
**Polished Nickel**  
**with Linen Shades**

Height: 12"  
 Width: 17.5"  
 Extension: 8.75"  
 Backplate:  
 5.25" Square

**Finishes:**  
 BZ, HAB, PN  
**Shade Treatments:**  
 L, WG  
**Shade Details:**  
 5" x 7" x 5.5"

**Socket:**  
 2 - Candelabra  
**Wattage:**  
 2 - 60 B

**Designer:**  
 AERIN

ARN2005HAB-L



**S20HAB-NPS**  
**Architectural Wall**  
**Sconce in Hand-**  
**Rubbed Antique Brass**  
**with Square Natural**  
**Paper Shade**  
Height: 13.5"  
Width: 7"  
Extension: 7"  
Backplate: 4.5" Square

**Finishes:**  
BS, HAB, PN  
**Shade Treatments:** NP  
**Shade Details:**  
4" x 7" x 6.5"

**Socket:** Candelabra  
**Wattage:** 40 B

**Designer:**  
Studio VC





**BBL2036I-S**  
**Refined Rib Sconce in Ivory Resin and Soft Silver with Silk Shade**  
 Height: 16.75"  
 Width: 7.75"  
 Extension: 8.5"  
 Backplate: 4" x 6" Rectangle

**Finishes:** EBO, I  
**Shade Treatments:** S  
**Shade Details:**  
 7.25" x 7.75" x 8.25"

**Socket:** Keyless  
**Wattage:** 75 A

**Designer:**  
 Barbara Barry

**BBL2036EBO-S**



**BBL2016I/SS-S**  
**Sunset Plaza Sconce in Ivory and Soft Silver with Antique Mirror and Ivory Silk Pleated Shade**  
 Height: 14"  
 Width: 9.25"  
 Extension: 6.5"  
 Backplate: 14" x 9.25" Rectangle

**Finishes:** BLK/SS, I/BZ, I/SS  
**Shade Treatments:** GS, S  
**Shade Details:**  
 7.5" x 7.5" x 8.25" Rectangle

**Socket:** Keyless  
**Wattage:** 60 A

**Designer:**  
 Barbara Barry

**BBL2016BLK/SS-GS**

**BBL2016I/BZ-S**



**BBL2030SS-S**  
**Lyric Branch Sconce**  
**in Soft Silver**  
**with Silk Shade**  
 Height: 19"  
 Width: 7.5"  
 Extension: 8"  
 Backplate: 4.25" x 6.5" Rectangle

**Finishes:**  
 BZ, PWT, SB, SS  
**Shade Treatments:** S  
**Shade Details:**  
 7" x 7.5" x 7.75"

**Socket:** Keyless  
**Wattage:** 75 A

**Designer:**  
 Barbara Barry

BBL2030PWT-S

BBL2030BZ-S



**BBL2025SS-S**  
**Petal Sconce in**  
**Soft Silver and**  
**Smoke Mirror Base**  
**with Silk Shade**  
 Height: 16.25"  
 Width: 7.5"  
 Extension: 8.5"  
 Backplate: 4.25" Square

**Finishes:**  
 BZ, SB, SS  
**Shade Treatments:** S  
**Shade Details:**  
 7" x 7.5" x 7.5"

**Socket:** Keyless  
**Wattage:** 75 A

**Designer:**  
 Barbara Barry

BBL2025SB-S

BBL2025BZ-S









**BBL2017SS-S**  
**Simple Scallop Wall**  
**Sconce in Soft Silver**  
**with Silk Shade**

Height: 16"  
Width: 9.25"  
Extension: 10.5"  
Backplate:  
4.5" x 7" Oval

**Finishes:**  
BZ, SB, SS  
**Shade Treatments:** S  
**Shade Details:**

8.75" x 9.25" x 8"  
Oval

**Socket:** Keyless  
**Wattage:** 75 A

**Designer:**  
Barbara Barry

BBL2017SB-S

BBL2017BZ-S



**BBL2023SS-S**  
**Westport Sconce**  
**in Soft Silver**  
**with Silk Shade**

Height: 16.5"  
Width: 7.5"  
Extension: 8"  
Backplate:  
4.75" Round

**Finishes:**  
BZ, PWT, SB, SS  
**Shade Treatments:** S  
**Shade Details:**  
7" x 7.5" x 7.5"

**Socket:** On-Off  
**Wattage:** 75 A

**Designer:**  
Barbara Barry

BBL2023PWT-S

BBL2023SB-S



**TOB2125PN-NP**  
**Reed Single Sconce in Polished Nickel with Natural Paper Shade**

Height: 13"  
 Width: 5"  
 Extension: 10.5"  
 Backplate: 4.5" Round

**Finishes:**  
 AN, BZ, HAB, PN, PS  
**Shade Treatments:** NP  
**Shade Details:**  
 4" x 5" x 6"

**Socket:**  
 Candelabra  
**Wattage:** 40 B

**Designer:**  
 Thomas O'Brien



**TOB2125HAB-NP**



**TOB2125BZ-NP**



**TOB2126PN-NP**  
**Reed Double Sconce in Polished Nickel with Natural Paper Shades**

Height: 13"  
 Width: 15"  
 Extension: 8.5"  
 Backplate: 4.5" Round

**Finishes:**  
 AN, BZ, HAB, PN, PS  
**Shade Treatments:** NP  
**Shade Details:**  
 4" x 5" x 6"

**Socket:**  
 2 - Candelabra  
**Wattage:** 2 - 40 B

**Designer:**  
 Thomas O'Brien



**TOB2126HAB-NP**







**TOB2002PN-NP/ST**  
**Bryant Sconce in Polished Nickel with Natural Paper Shade and Silver Tape**  
Height: 14.25"  
Width: 5.5"  
Extension: 8.75"  
Backplate: 4" Round

**Finishes:**  
AN, BZ, HAB, PN  
**Shade Treatments:**  
NP, NP/BT, NP/ST  
**Shade Details:**  
4" x 5.5" x 6"

**Socket:** Keyless  
**Wattage:** 60 A

**Note:** Requires a Smaller Outlet Box

**Designer:**  
Thomas O'Brien

TOB2002AN-NP



TOB2002HAB-NP



TOB2002BZ-NP/BT



**TOB2007PN-NP**  
**Vendome Single Sconce**  
**in Polished Nickel with**  
**Natural Paper Shade**

Height: 14"  
 Width: 5.5"  
 Extension: 8.5"  
 Backplate: 5.25" Round

**Finishes:**  
 AS, BZ, HAB, PN  
**Shade Treatments:** NP  
**Shade Details:**  
 4" x 5.5" x 6"

**Socket:** Keyless  
**Wattage:** 60 A

**Designer:**  
 Thomas O'Brien



**TOB2007BZ-NP**

**TOB2008BZ-NP**  
**Vendome Double Sconce**  
**in Bronze with**  
**Natural Paper Shades**

Height: 14"  
 Width: 18"  
 Extension: 9"  
 Backplate: 5.25" Round

**Finishes:**  
 AS, BZ, HAB, PN  
**Shade Treatments:** NP  
**Shade Details:**  
 4" x 5.5" x 6"

**Socket:** 2 - Keyless  
**Wattage:** 2 - 60 A

**Designer:**  
 Thomas O'Brien



**TOB2009HAB-NP**  
**Vendome Triple Sconce**  
**in Hand-Rubbed**  
**Antique Brass with**  
**Natural Paper Shades**

Height: 14"  
 Width: 22"  
 Extension: 11"  
 Backplate: 5.25" Round

**Finishes:**  
 AS, BZ, HAB, PN  
**Shade Treatments:** NP  
**Shade Details:**  
 4" x 5.5" x 6"

**Socket:** 3 - Keyless  
**Wattage:** 3 - 60 A

**Designer:**  
 Thomas O'Brien







**SP2022PN-NP**  
**Hackney Single**  
**Sconce in Polished**  
**Nickel with Natural**  
**Paper Shade**  
 Height: 14"  
 Width: 9"  
 Extension: 9.25"  
 Backplate: 4" Round

**Finishes:**  
 BZ, HAB, PN  
**Shade Treatments:** NP  
**Shade Details:**  
 2.5" x 9" x 5"

**Socket:** Keyless  
**Wattage:** 40 B

**Designer:**  
 J. Randall Powers

SP2022HAB-NP

SP2022BZ-NP



**SP2504PN-NP**  
**Hargett Single**  
**Sconce in Polished**  
**Nickel with Natural**  
**Paper Shade**  
 Height: 26"  
 Width: 11.75"  
 Extension: 7.5"  
 Backplate: 4" Round

**Finishes:**  
 BZ, HAB, PN  
**Shade Treatments:**  
 NP  
**Shade Details:**  
 3" x 11.75" x 7"

**Socket:** Keyless  
**Wattage:** 60 B

**Designer:**  
 J. Randall Powers

SP2504HAB-NP

SP2504BZ-NP



**TOB2740PN-NP**  
**Edie Sconce in Polished Nickel with Natural Paper Shade**  
Height: 18.5"  
Width: 5.5"  
Extension: 6.75"  
Backplate: 4.5" Round

**Finishes:**  
AN, BZ, BZ/HAB, HAB, PN  
**Shade Treatments:** NP  
**Shade Details:**  
5" x 5.5" x 8"

**Socket:** Keyless  
**Wattage:** 60 A

**Designer:**  
Thomas O'Brien

**TOB2740HAB-NP**



**TOB2740BZ-NP**



**TOB2741PN-NP**  
**Edie Baluster Sconce in Polished Nickel with Natural Paper Shade**  
Height: 32.75"  
Width: 10"  
Extension: 7"  
Backplate: 3" Round

**Finishes:**  
AN, BZ, BZ/HAB, HAB, PN  
**Shade Treatments:** NP  
**Shade Details:**  
9" x 10" x 8"  
Shield

**Socket:**  
2 - Candelabra  
**Wattage:** 2 - 40 C

**Note:** Requires a Smaller Outlet Box

**Designer:**  
Thomas O'Brien

**TOB2741HAB-NP**



**TOB2741BZ/HAB-NP**





**TOB2067PS-NP**  
Elkins Sconce in  
Polished Silver with  
Natural Paper Shade  
Height: 12.75"  
Width: 5.5"  
Extension: 7"  
Backplate: 5.5" Round

**Finishes:**  
AN/PN, BZ/HAB, PS  
**Shade Treatments:**  
FS, NP, NP/BT  
**Shade Details:**  
3.5" x 4" x 6"

**Socket:** Candelabra  
**Wattage:** 40 B

**Designer:**  
Thomas O'Brien



**TOB2067AN/PN-NP**



**TOB2067BZ/HAB-NP/BT**



**TOB2068PS-NP**  
Elkins Double Sconce  
in Polished Silver with  
Natural Paper Shades  
Height: 13.25"  
Width: 9.5"  
Extension: 8.75"  
Backplate: 5.5" Round

**Finishes:**  
AN/PN, BZ/HAB, PS  
**Shade Treatments:**  
NP, NP/BT  
**Shade Details:**  
3.5" x 4" x 6"

**Socket:**  
2 - Candelabra  
**Wattage:** 2 - 40 B

**Designer:**  
Thomas O'Brien



**TOB2068BZ/HAB-NP/BT**



**TOB2010PN-NP**  
**Longacre Sconce in Polished Nickel with Natural Paper Shade**  
 Height: 14"  
 Width: 6"  
 Extension: 7"  
 Backplate: 5" Round

**Finishes:**  
 BZ, HAB, PN  
**Shade Treatments:** NP  
**Shade Details:**  
 4" x 6" x 6"

**Socket:** Hi-Lo  
**Wattage:** 60 A

**Designer:**  
 Thomas O'Brien

TOB2010HAB-NP

TOB2010BZ-NP



**TOB2081AN/PN-NP**  
**Alton Pivoting Sconce in Antique Nickel and Polished Nickel with Natural Paper Shade**  
 Height: 16.5"  
 Width: 6"  
 Extension: 8"  
 Backplate: 4.5" x 5.75" Oval

**Finishes:**  
 AN/PN, BZ,  
 BZ/HAB, HAB, PN  
**Shade Treatments:**  
 NP, NP/BT  
**Shade Details:**  
 4" x 6" x 6.5"

**Socket:** Hi-Lo  
**Wattage:** 60 A

**Designer:**  
 Thomas O'Brien

TOB2081HAB-NP

TOB2081BZ/HAB-NP/BT



**TOB2011PN-NP**  
**Metropolitan Sconce**  
in Polished Nickel  
with Natural  
Paper Shade  
Height: 11"  
Width: 5"  
Extension: 6.25"  
Backplate: 4.5" Round

**Finishes:**  
BZ, CH, HAB, PN  
**Shade Treatments:**  
NP, NP/BT, WG  
**Shade Details:**  
5" x 5" x 5.5" Shield

**Socket:** Keyless  
**Wattage:** 60 A

**Designer:**  
Thomas O'Brien

**TOB2011HAB-NP**

**TOB2011BZ-NP/BT**



**TOB2036PN-NP**  
**Chantal Horn Sconce**  
in Polished Nickel  
with Natural  
Paper Shade  
Height: 17.75"  
Width: 6"  
Extension: 5.5"  
Backplate:  
4" x 5" Round

**Finishes:**  
BZ, HAB, PN  
**Shade Treatments:** NP  
**Shade Details:**  
5" x 6" x 10"

**Socket:** Keyless  
**Wattage:** 40 B

**Designer:**  
Thomas O'Brien

**TOB2036HAB-NP**

**TOB2036BZ-NP**



**TOB2017PN-NP**  
**Ziyi Sconce in**  
**Polished Nickel with**  
**Natural Paper Shade**  
 Height: 13.75"  
 Width: 4.25"  
 Extension: 5.5"  
 Backplate: 4.25" Round

**Finishes:**  
 BZ, HAB, PN  
**Shade Treatments:** NP  
**Shade Details:**  
 3" x 3.5" x 7.5"

**Socket:** Candelabra  
**Wattage:** 25 B

**Note:** Uses Smaller  
 Outlet Box

**Designer:**  
 Thomas O'Brien



TOB2017HAB-NP



TOB2017BZ-NP



**ARN2018PN-L**  
**Drunmore Single**  
**Sconce in**  
**Polished Nickel**  
**with Linen Shade**  
 Height: 14.25"  
 Width: 4.5"  
 Extension: 6.75"  
 Backplate: 4.5" Round

**Finishes:**  
 BZ, BZ/CG, HAB,  
 HAB/CG, PN, PN/CG  
**Shade Treatments:**  
 L, WG  
**Shade Details:**  
 4.5" x 4.5" x 8.5"

**Socket:** Candelabra  
**Wattage:** 40 B

**Designer:**  
 AERIN



ARN2018HAB-L



ARN2018BZ/CG-L







**TOB2190PN-NP**  
**Hulton Sconce in Polished Nickel with Natural Paper Shade**  
 Height: 16.5"  
 Width: 6"  
 Extension: 7.5"  
 Backplate: 4" x 7.25" Rectangle

**Finishes:**  
 BZ, HAB, PN  
**Shade Treatments:** NP  
**Shade Details:**  
 4" x 6" x 6.5" Oval

**Socket:** Candelabra  
**Wattage:** 40 B

**Designer:**  
 Thomas O'Brien

TOB2190HAB-NP

TOB2190BZ-NP



**TOB2191PN-NP**  
**Hulton Double Sconce in Polished Nickel with Natural Paper Shades**  
 Height: 16.5"  
 Width: 14"  
 Extension: 9.5"  
 Backplate: 4" x 7.25" Rectangle

**Finishes:**  
 BZ, HAB, PN  
**Shade Treatments:**  
 NP  
**Shade Details:**  
 4" x 6" x 6.5" Oval

**Socket:**  
 2 - Candelabra  
**Wattage:** 2 - 40 B

**Designer:**  
 Thomas O'Brien

TOB2191BZ-NP



**SL2845PN-NP**  
**Wilton Single**  
**Sconce in Polished**  
**Nickel with Natural**  
**Paper Shade**  
Height: 13.75"  
Width: 5"  
Extension: 8"  
Backplate: 5" Round

**Finishes:**  
AN, BZ, HAB, PN  
**Shade Treatments:** NP  
**Shade Details:**  
4.25" x 4.5" x 5.5"

**Socket:** Candelabra  
**Wattage:** 60 B

**Designer:**  
E. F. Chapman

©EFC DESIGNS

**SL2845HAB-NP**

**SL2845BZ-NP**



**SL2846PN-NP**  
**Wilton Double**  
**Sconce in Polished**  
**Nickel with Natural**  
**Paper Shades**  
Height: 13.75"  
Width: 12.5"  
Extension: 8"  
Backplate: 5" Round

**Finishes:**  
AN, BZ, HAB, PN  
**Shade Treatments:**  
NP  
**Shade Details:**  
4.25" x 4.5" x 5.5"

**Socket:**  
2 - Candelabra  
**Wattage:** 2 - 60 B

**Designer:**  
E. F. Chapman

©EFC DESIGNS

**SL2846HAB-NP**



**TOB2170PN-NP**  
**Paulina Sconce in Polished Nickel with Natural Paper Shade**  
 Height: 15.25"  
 Width: 5"  
 Extension: 6.5"  
 Backplate: 5" Round

**Finishes:**  
 BZ, HAB, PN  
**Shade Treatments:**  
 NP  
**Shade Details:**  
 3.5" x 5" x 6"

**Socket:** Candelabra  
**Wattage:** 40 B

**Designer:**  
 Thomas O'Brien

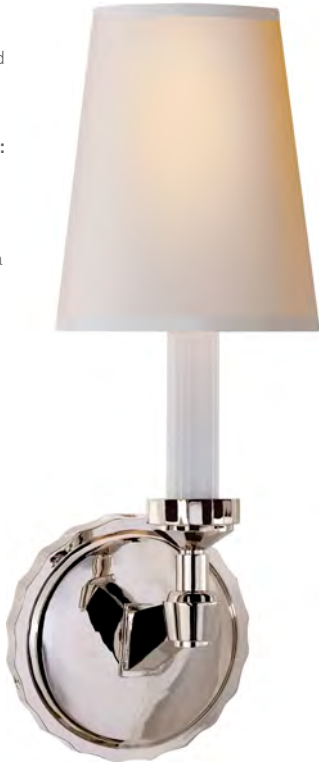

**TOB2170HAB-NP**



**TOB2170BZ-NP**



**TOB2070PN-NP**  
**Leyland Sconce in Polished Nickel with Natural Paper Shade**  
 Height: 15.25"  
 Width: 6"  
 Extension: 8.25"  
 Backplate: 5.5" x 7"

**Finishes:**  
 AI, HAB, PN, SN  
**Shade Treatments:**  
 NP  
**Shade Details:**  
 4" x 6" x 6.5"

**Socket:** Candelabra  
**Wattage:** 60 B

**Designer:**  
 Thomas O'Brien



**TOB2070HAB-NP**



**TOB2070AI-NP**



**AH2004PN-NP**  
**Bing Single Arm**  
**Sconce in Polished**  
**Nickel with Natural**  
**Paper Shade**  
Height: 12"  
Width: 8.25"  
Extension: 11"  
Backplate: 4.5" Round

**Finishes:**  
GM, NB, PN  
**Shade Treatments:**  
NP  
**Shade Details:**  
4.25" x 8.25" x 6.5"

**Socket:** Keyless  
**Wattage:** 60 A

**Designer:**  
Alexa Hampton

AH2004NB-NP

AH2004GM-NP



**AH2010PN-NP**  
**Ginger Single Arm**  
**Sconce in Polished**  
**Nickel with Natural**  
**Paper Shade**  
Height: 15.5"  
Width: 8.25"  
Extension: 10"  
Backplate:  
3" x 11" Rectangle

**Finishes:**  
GM, NB, PN  
**Shade Treatments:**  
NP  
**Shade Details:**  
4.25" x 8.25" x 6.5"

**Socket:** Keyless  
**Wattage:** 60 A

**Note:** Requires a  
Smaller Outlet Box

**Designer:**  
Alexa Hampton

AH2010NB-NP

AH2010GM-NP



**AH2003PN-NP**  
**Abbot Library**  
**Sconce in Polished**  
**Nickel with Natural**  
**Paper Shade**  
 Height: 11"  
 Width: 6.5"  
 Extension: 7"  
 Backplate:  
 2.75" x 4.5" Rectangle

**Finishes:**  
 BN, GM, NB, PN  
**Shade Treatments:**  
 NP  
**Shade Details:**  
 3" x 6.5" x 5"

**Socket:** Candelabra  
**Wattage:** 40 B

**Note:** Requires a  
 Smaller Outlet Box

**Designer:**  
 Alexa Hampton

AH2003NB-NP

AH2003GM-NP



**AH2002PN-NP**  
**Abbot Single Arm**  
**Sconce in Polished**  
**Nickel with Natural**  
**Paper Shade**  
 Height: 13"  
 Width: 8.25"  
 Extension: 10"  
 Backplate:  
 3.5" x 4.5" Rectangle

**Finishes:**  
 BN, GM, NB, PN  
**Shade Treatments:**  
 NP  
**Shade Details:**  
 4.25" x 8.25" x 6.5"

**Socket:** Keyless  
**Wattage:** 60 A

**Note:** Requires a  
 Smaller Outlet Box

**Designer:**  
 Alexa Hampton

AH2002NB-NP

AH2002GM-NP





**AH2015PN-NP**  
**Gene Single Arm**  
**Sconce in Polished**  
**Nickel with Natural**  
**Paper Shade**  
 Height: 12.75"  
 Width: 8.25"  
 Extension: 10.25"  
 Backplate:  
 3.5" x 4.5" Rectangle

**Finishes:**  
 BN, GM, NB, PN  
**Shade Treatments:**  
 NP  
**Shade Details:**  
 4.25" x 8.25" x 6.5"

**Socket:** Keyless  
**Wattage:** 60 A

**Note:** Requires a  
 Smaller Outlet Box

**Designer:**  
 Alexa Hampton

AH2015NB-NP

AH2015GM-NP



**AH2013PN-NP**  
**Gene Library Sconce**  
**in Polished Nickel**  
**with Natural**  
**Paper Shade**  
 Height: 11"  
 Width: 6.5"  
 Extension: 7"  
 Backplate:  
 2.75" x 4.5" Rectangle

**Finishes:**  
 BN, GM, NB, PN  
**Shade Treatments:**  
 NP  
**Shade Details:**  
 3" x 6.5" x 5"

**Socket:** Candelabra  
**Wattage:** 40 B

**Note:** Requires a  
 Smaller Outlet Box

**Designer:**  
 Alexa Hampton

AH2013NB-NP

AH2013GM-NP





**AH2000PN-NP**  
Dean Single Arm  
Sconce in Polished  
Nickel with Natural  
Paper Shade  
Height: 12.75"  
Width: 8.25"  
Extension: 10.25"  
Backplate:  
3.5" x 4.5" Rectangle

**Finishes:**  
GM, NB, PN  
**Shade Treatments:**  
NP  
**Shade Details:**  
4.25" x 8.25" x 6.5"

**Socket:** Keyless  
**Wattage:** 60 A

**Note:** Requires a  
Smaller Outlet Box

**Designer:**  
Alexa Hampton

AH2000NB-NP

AH2000GM-NP



**AH2001PN-NP**  
Dean Library  
Sconce in Polished  
Nickel with Natural  
Paper Shade  
Height: 13"  
Width: 6.5"  
Extension: 7"  
Backplate:  
2.75" x 4.5" Rectangle

**Finishes:**  
BN, GM, NB, PN  
**Shade Treatments:**  
NP  
**Shade Details:**  
3" x 6.5" x 5"

**Socket:** Candelabra  
**Wattage:** 40 B

**Note:** Requires a  
Smaller Outlet Box

**Designer:**  
Alexa Hampton

AH2001NB-NP

AH2001GM-NP



SC2106PN

**Tyler Single Sconce in Polished Nickel**

Height: 12.5"  
 Width: 3.5"  
 Extension: 5"  
 Backplate:  
 3.5" x 5.5" Rectangle

**Finishes:**  
 AS, BZ, HAB, PN

**Socket:** Candelabra  
**Wattage:** 60 C

**Note:** Cord Cover  
 Included/Requires  
 Smaller Outlet Box/  
 CHS104NP Shade  
 Sold Separately

**Designer:**  
 Eric Cohler

SC2106HAB

SC2106BZ



AH2305PN-NP

**Jane Wall Sconce in Polished Nickel with Natural Paper Shade**

Height: 13.5"  
 Width: 7"  
 Extension: 8.5"  
 Backplate:  
 3.25" x 4.75" Rectangle

**Finishes:**  
 AN, GM, HAB, PN  
**Shade Treatments:** NP  
**Shade Details:**  
 3.5" x 7" x 6"

**Socket:** Keyless  
**Wattage:** 60 A

**Note:** Requires a  
 Smaller Outlet Box

**Designer:**  
 Alexa Hampton

AH2305HAB-NP

AH2305GM-NP



**MS2012HAB-NP**  
**Edgartown Single Sconce**  
 in Hand-Rubbed  
 Antique Brass with  
 Natural Paper Shade  
 Height: 15"  
 Width: 8"  
 Extension: 13"  
 Backplate:  
 6" x 7.5" Rectangle

**Finishes:**  
 BZ, HAB, PN, SN  
**Shade Treatments:**  
 NP  
**Shade Details:**  
 4.5" x 8" x 6.25"

**Socket:**  
 Candelabra  
**Wattage:** 60 B

**Designer:**  
 Michael S Smith



**MS2013BZ-NP**  
**Edgartown Double**  
**Sconce in Bronze with**  
**Natural Paper Shades**  
 Height: 15"  
 Width: 22"  
 Extension: 13"  
 Backplate:  
 6" x 7.5" Rectangle

**Finishes:**  
 BZ, HAB, PN, SN  
**Shade Treatments:**  
 NP  
**Shade Details:**  
 4.5" x 8" x 6.25"

**Socket:**  
 2 - Candelabra  
**Wattage:**  
 2 - 60 B

**Designer:**  
 Michael S Smith



**MS2020PN-NP**  
**Eiffel Single Sconce in**  
**Polished Nickel with**  
**Natural Paper Shade**  
 Height: 13"  
 Width: 7"  
 Extension: 13"  
 Backplate:  
 6" x 8" Rectangle

**Finishes:**  
 BZ, HAB, PN, SN  
**Shade Treatments:**  
 NP  
**Shade Details:**  
 5" x 7" x 5.5"

**Socket:**  
 Candelabra  
**Wattage:** 60 B

**Designer:**  
 Michael S Smith



**MS2021SN-NP**  
**Eiffel Double**  
**Sconce in Sheffield**  
**Nickel with Natural**  
**Paper Shades**  
 Height: 13"  
 Width: 19"  
 Extension: 12"  
 Backplate:  
 6" x 8" Rectangle

**Finishes:**  
 BZ, HAB, PN, SN  
**Shade Treatments:**  
 NP  
**Shade Details:**  
 5" x 7" x 5.5"

**Socket:**  
 2 - Candelabra  
**Wattage:**  
 2 - 60 B

**Designer:**  
 Michael S Smith



TOB2135SN/AN-NP

**Calliope Single Sconce in Sheffield Nickel and Antique Nickel with Natural Paper Shade**  
 Height: 14.75"  
 Width: 6"  
 Extension: 8"  
 Backplate: 4" x 8" Oval

**Finishes:**  
 BR/HAB, HAB, PN, SN/AN

**Shade Treatments:**  
 NP

**Shade Details:**  
 4" x 6" x 6.25"

**Socket:** Candelabra  
**Wattage:** 60 B

**Designer:**  
 Thomas O'Brien



TOB2135BR/HAB-NP



TOB2135HAB-NP



**TOB2137HAB-NP Calliope Three-Light Sconce in Hand-Rubbed Antique Brass with Natural Paper Shade**  
 Height: 20.25"  
 Width: 11"  
 Extension: 9.75"  
 Backplate: 4" x 8" Oval

**Finishes:**  
 BR/HAB, HAB, PN, SN/AN

**Shade Treatments:**  
 NP

**Shade Details:**  
 9.5" x 11" x 10"

**Socket:**  
 3 - Candelabra  
**Wattage:** 3 - 40 B

**Designer:**  
 Thomas O'Brien

TOB2137BR/HAB-NP



**TOB2327SN-NP**  
Modern Library  
Sconce in Sheffield  
Nickel with Natural  
Paper Shade  
Height: 14"  
Width: 5"  
Extension: 7.75"  
Backplate:  
4" x 6.5" Rectangle

**Finishes:**  
BZ, HAB, PN, SN  
**Shade Treatments:** NP  
**Shade Details:**  
3.5" x 5" x 6"

**Socket:** Candelabra  
**Wattage:** 40 B

**Designer:**  
Thomas O'Brien

**TOB2327HAB-NP**

**TOB2327BZ-NP**



**TOB2328PN-NP**  
Modern Library  
Double Sconce in  
Polished Nickel with  
Natural Paper Shades  
Height: 14.5"  
Width: 11.5"  
Extension: 8.25"  
Backplate:  
4" x 6.5" Rectangle

**Finishes:**  
BZ, HAB, PN, SN  
**Shade Treatments:**  
NP  
**Shade Details:**  
3.5" x 5" x 6"

**Socket:**  
2 - Candelabra  
**Wattage:** 2 - 40 B

**Designer:**  
Thomas O'Brien

**TOB2328BZ-NP**



**TOB2120PS-NP**  
**Channing Single Sconce in Polished Silver with Natural Paper Shade**

Height: 14"  
 Width: 6"  
 Extension: 9.5"  
 Backplate:  
 5.5" x 6.25" Oval

**Finishes:**  
 BZ, HAB, PS  
**Shade Treatments:** NP  
**Shade Details:**  
 4.5" x 6"x 5.5" Oval

**Socket:** Candelabra  
**Wattage:** 40 B

**Designer:**  
 Thomas O'Brien

**TOB2120HAB-NP**

**TOB2120BZ-NP**



**TOB2121HAB-NP**  
**Channing Double Sconce in Hand-Rubbed Antique Brass with Natural Paper Shades**

Height: 14"  
 Width: 15"  
 Extension: 9.5"  
 Backplate:  
 5.5" x 6.25" Oval

**Finishes:**  
 BZ, HAB, PS  
**Shade Treatments:**  
 NP  
**Shade Details:**  
 4.5" x 6"x 5.5"  
 Oval

**Socket:**  
 2 - Candelabra  
**Wattage:** 2 - 40 B

**Designer:**  
 Thomas O'Brien

**TOB2121BZ-NP**



**TOB2110PS-NP**  
**Chandler Single**  
**Sconce in Polished**  
**Silver with Natural**  
**Paper Shade**

Height: 20"  
Width: 6"  
Extension: 10.75"  
Backplate:  
5.5" x 6.25" Oval

**Finishes:** BR/HAB,  
BSL, BZ, HAB, PS  
**Shade Treatments:** NP  
**Shade Details:**  
4" x 6" x 6.5"

**Socket:** Keyless  
**Wattage:** 60 A

**Designer:**  
Thomas O'Brien



**TOB2110BSL-NP**



**TOB2110HAB-NP**



**TOB2110BR/HAB-NP**



**SL2813PN**  
**Single Library**  
**Classic Sconce in**  
**Polished Nickel**  
 Height: 8.25"  
 Width: 3.5"  
 Extension: 6"  
 Backplate:  
 2.75" x 4.5" Rectangle

**Finishes:**  
 AN, BZ, HAB, PN

**Socket:** Candelabra  
**Wattage:** 60 C

**Note:** Cord Cover  
 Included/Requires  
 Smaller Outlet Box/  
 CHS104NP Shade  
 Sold Separately

**Designer:**  
 E. F. Chapman

©EFC DESIGNS

SL2813HAB

SL2813BZ



**SL2814HAB**  
**Double Library**  
**Classic Sconce**  
**in Hand-Rubbed**  
**Antique Brass**  
 Height: 8.25"  
 Width: 10.25"  
 Extension: 6"  
 Backplate:  
 2.75" x 4.5" Rectangle

**Finishes:**  
 AN, BZ, HAB, PN

**Socket:**  
 2 - Candelabra  
**Wattage:** 2 - 60 C

**Note:** Requires  
 Smaller Outlet Box/  
 CHS104NP Shade  
 Sold Separately

**Designer:**  
 E. F. Chapman

©EFC DESIGNS

SL2814BZ





**S2001PN-L**  
**Classic Single Sconce in Polished Nickel with Linen Shade**  
 Height: 12"  
 Width: 6"  
 Extension: 9.25"  
 Backplate: 4.75" Round

**Finishes:**  
 AN, BZ, HAB, PN  
**Shade Treatments:**  
 L, NP, T  
**Shade Details:**  
 3" x 6" x 5"

**Socket:** Candelabra  
**Wattage:** 40 B

**Designer:**  
 Studio VC

**S2001HAB-NP**

**S2001BZ-L**



**SL2815HAB**  
**Classic Single Sconce in Hand-Rubbed Antique Brass**  
 Height: 8"  
 Width: 4.5"  
 Extension: 7"  
 Backplate: 4.5" Round

**Finishes:**  
 AN, BZ, HAB, PN

**Socket:** Candelabra  
**Wattage:** 60 C

**Note:**  
 CHS104NP Shade Sold Separately/  
 Use 40 Watt Frosted Type "B" with Clip On Shade

**Designer:**  
 E. F. Chapman

©EFC DESIGNS

**SL2816AN**  
**Classic Double Sconce in Antique Nickel**  
 Height: 8"  
 Width: 11"  
 Extension: 7"  
 Backplate: 4.5" Round

**Finishes:**  
 AN, BZ, HAB, PN

**Socket:**  
 2 - Candelabra  
**Wattage:** 2 - 60 C

**Note:**  
 CHS104NP Shade Sold Separately/  
 Use 40 Watt Frosted Type "B" with Clip On Shade

**Designer:**  
 E. F. Chapman

©EFC DESIGNS



**S2210PN-NP**  
**French Single Library Sconce in Polished Nickel with Natural Paper Shade**  
 Height: 12"  
 Width: 6"  
 Extension: 6.75"  
 Backplate: 2.5" x 4.5" Rectangle

**Finishes:** AN, BZ, HAB, PN  
**Shade Treatments:** L, NP, T  
**Shade Details:** 3" x 6" x 5"

**Socket:** Candelabra  
**Wattage:** 40 B

**Note:** Requires a Smaller Outlet Box

**Designer:** Studio VC

S2210HAB-NP

S2210BZ-NP



**S2212PN-NP**  
**French Double Library Sconce in Polished Nickel with Natural Paper Shades**  
 Height: 12"  
 Width: 12"  
 Extension: 8.75"  
 Backplate: 2.5" x 4.5" Rectangle

**Finishes:** AN, BZ, HAB, PN  
**Shade Treatments:** L, NP, T  
**Shade Details:** 3" x 5" x 4"

**Socket:** 2 - Candelabra  
**Wattage:** 2 - 40 B

**Note:** Requires a Smaller Outlet Box

**Designer:** Studio VC

S2212HAB-NP



**S2110PN-NP**  
**French Single Sconce**  
**in Polished Nickel**  
**with Natural**  
**Paper Shade**  
 Height: 12"  
 Width: 6"  
 Extension: 10"  
 Backplate: 4.5" Round

**Finishes:**  
 AN, BZ, HAB, PN  
**Shade Treatments:**  
 L, NP, T  
**Shade Details:**  
 3" x 6" x 5"

**Socket:** Candelabra  
**Wattage:** 40 B

**Designer:**  
 Studio VC

S2110AN-L

S2110HAB-L



**S2112HAB-NP**  
**French Double Sconce**  
**in Hand-Rubbed**  
**Antique Brass with**  
**Natural Paper Shades**  
 Height: 12"  
 Width: 12.5"  
 Extension: 10"  
 Backplate: 4.5" Round

**Finishes:**  
 AN, BZ, HAB, PN  
**Shade Treatments:**  
 L, NP, T  
**Shade Details:**  
 3" x 6" x 5"

**Socket:**  
 2 - Candelabra  
**Wattage:** 2 - 40 B

**Designer:**  
 Studio VC

S2112AN-NP



**S2005PN-NP**  
**Single Swing Arm**  
**Sconce in Polished**  
**Nickel with Natural**  
**Paper Shade**  
 Height: 12"  
 Width: 6"  
 Extension: 7"  
 Backplate: 3.5" x 4.5"

**Finishes:**  
 AN, BZ, HAB, PN  
**Shade Treatments:**  
 L, NP  
**Shade Details:**  
 3" x 6" x 5"

**Socket:** Candelabra  
**Wattage:** 40 B

**Note:** Requires a  
 Smaller Outlet Box

**Designer:**  
 Studio VC

S2005HAB-L

S2005BZ-NP



**CHD1175PN**  
**EFC Library**  
**Wall Sconce in**  
**Polished Nickel**  
 Height: 13.5"  
 Width: 4"  
 Extension: 8.25"  
 Backplate: 3" x 5" Rectangle

**Finishes:**  
 AB, AN, BZ, PN, PS

**Socket:** Candelabra  
**Wattage:** 60 C

**Note:**  
 CHS104NP Shade  
 Sold Separately/  
 Use 40 Watt Frosted  
 Type "B" with  
 Clip On Shade

**Designer:**  
 E. F. Chapman

©EFC DESIGNS

CHD1175AB

CHD1175BZ



**TOB2335AN-NP**  
**Gallois Sconce in**  
**Antique Nickel with**  
**Natural Paper Shade**  
 Height: 13"  
 Width: 5"  
 Extension: 9.5"  
 Backplate:  
 3.5" x 6.5" Rectangle

**Finishes:**  
 AN, BZ, HAB, PN  
**Shade Treatments:** NP  
**Shade Details:**  
 4" x 5" x 5"

**Socket:** Candelabra  
**Wattage:** 60 B

**Note:** Requires a  
 Smaller Outlet Box

**Designer:**  
 Thomas O'Brien

TOB2335HAB-NP

TOB2335BZ-NP



**MS2015PN-NP**  
**Winslow Single**  
**Sconce in Polished**  
**Nickel with Natural**  
**Paper Shade**  
 Height: 27"  
 Width: 6"  
 Extension: 14.5"  
 Backplate:  
 5" x 8" Rectangle

**Finishes:**  
 BZ, HAB, PN  
**Shade Treatments:** NP  
**Shade Details:**  
 4" x 6" x 6"

**Socket:** Candelabra  
**Wattage:** 60 B

**Designer:**  
 Michael S Smith

MS2015HAB-NP

MS2015BZ-NP



**CHD2465AN-NP**  
**Fluted Horn Single Sconce in Antique Nickel with Natural Paper Shade**  
 Height: 15"  
 Width: 6"  
 Extension: 7.5"  
 Backplate: 4" x 6" Oval

**Finishes:**  
 AB, AN, BZ  
**Shade Treatments:** NP  
**Shade Details:**  
 3.25" x 6" x 4.25"

**Socket:** Candelabra  
**Wattage:** 60 C

**Designer:**  
 E. F. Chapman

©EFC DESIGNS

CHD2465AB-NP

CHD2465BZ-NP



**CHD2466AN**  
**Fluted Horn Double Sconce in Antique Nickel**  
 Height: 14.5"  
 Width: 9"  
 Extension: 5.25"  
 Backplate: 4" x 6" Oval

**Finishes:** AB, AN, BZ  
**Shade Details:**  
 CHS104NP  
 Sold Separately

**Socket:**  
 2 - Candelabra  
**Wattage:** 2 - 60 C

**Note:** Use 40 Watt Frosted Type "B" with Clip On Shade

**Designer:**  
 E. F. Chapman

©EFC DESIGNS

CHD2466AB



**CHD1161PN**  
**Horn Single Sconce**  
**in Polished Nickel**

Height: 12.5"  
Width: 3"  
Extension: 5.75"  
Backplate: 3" x 7"

**Finishes:** AB, BZ, PN

**Socket:** Candelabra  
**Wattage:** 60 C

**Note:**

CHS111S Shade  
Sold Separately/Use  
40 Watt Frosted  
Type "B" with  
Clip On Shade

**Designer:**

E. F. Chapman

©EFC DESIGNS

CHD1161AB



CHD1161BZ



**S2101PN**  
**Empire Long Sconce**  
**in Polished Nickel**

Height: 10.25"  
Width: 3"  
Extension: 7"  
Backplate: 2.5" x 10"

**Finishes:** HAB, PN

**Shade Details:**

CHS104NP  
Sold Separately

**Socket:** Candelabra

**Wattage:** 60 C

**Note:** Cord Cover  
Included/Requires  
Smaller Outlet Box

**Designer:**

Studio VC

S2101HAB



**CHD1138AN**  
**Grosvenor House**  
**Single Sconce in**  
**Antique Nickel**  
 Height: 10.5"  
 Width: 4.5"  
 Extension: 8"  
 Backplate:  
 4.5" x 6.5" Oval

CHD1138AB

CHD1138BZ

**Finishes:**  
 AB, AN, BZ, PS, SN

**Socket:** Candelabra  
**Wattage:** 60 C

**Note:**  
 CHS109S Shade  
 Sold Separately/Use  
 40 Watt Frosted  
 Type "B" with  
 Clip On Shade

**Designer:**  
 E. F. Chapman

©EFC DESIGNS



**CHD1139AB**  
**Grosvenor House**  
**Double Sconce in**  
**Antique-Burnished Brass**  
 Height: 10.5"  
 Width: 10.5"  
 Extension: 8"  
 Backplate:  
 4.5" x 6.5" Oval

CHD1139SN

**Finishes:**  
 AB, AN, BZ, PS, SN

**Socket:**  
 2 - Candelabra  
**Wattage:** 2 - 60 C

**Note:**  
 CHS109S Shade  
 Sold Separately/Use  
 40 Watt Frosted  
 Type "B" with  
 Clip On Shade

**Designer:**  
 E. F. Chapman

©EFC DESIGNS





**SP2000PN-NP**  
**Savoy Sconce in Polished Nickel with Natural Paper Shades**  
Height: 15.5"  
Width: 15.5"  
Extension: 9.5"  
Backplate: 4.5" Round

**Finishes:**  
BZ, HAB, PN, SHS  
**Shade Treatments:**  
NP  
**Shade Details:**  
3" x 6.5" x 5"

**Socket:**  
2 - Candelabra  
**Wattage:** 2 - 40 B

**Designer:**  
J. Randall Powers

SP2000BZ-NP



**CHD1122AB**  
**English Two-Light Sconce in Antique-Burnished Brass**  
Height: 13.25"  
Width: 10"  
Extension: 7"  
Backplate: 4.5" Round

**Finishes:** AB, AN, BZ

**Socket:**  
2 - Candelabra  
**Wattage:** 2 - 60 C

**Note:**  
CHS104NP Sold Separately/Use 40 Watt Frosted Type "B" with Clip On Shade

**Designer:**  
E. F. Chapman

©EFC DESIGNS

CHD1122BZ





**CHD2102PN**  
**Georgian Small**  
**Hurricane Wall Sconce**  
**in Polished Nickel**

Height: 22"  
Width: 7.5"  
Extension: 8.75"  
Backplate:  
4.25" Round

**Finishes:**  
AB, AN, BZ, PN  
**Glass Options:** CG

**Socket:** Candelabra  
**Wattage:** 60 C

**Designer:**  
E. F. Chapman

©EFC DESIGNS

CHD2102AB



CHD2102BZ



**CHD2000PN**  
**Edwardian Medium**  
**Half Round Wall Lantern**  
**in Polished Nickel**

Height: 10"  
Width: 8.5"  
Extension: 6"  
Backplate:  
8.5" x 10" Rectangle

**Finishes:**  
AB, AN, BZ, PN  
**Glass Options:** CG

**Socket:**  
2 - Candelabra  
**Wattage:** 2 - 60 C

**Note:**  
Polished Aluminum  
Inside Back

**Designer:**  
E. F. Chapman

©EFC DESIGNS

CHD2000AN



CHD2000AB



**CHD2908PN**  
**Linear Lantern Short**  
**in Polished Nickel**  
Height: 15"  
Width: 9"  
Extension: 5"  
Backplate:  
9" x 13" Rectangle

**Finishes:**  
AB, AN, BZ, PN, WZ  
**Glass Options:** CG

**Socket:**  
2 - Candelabra  
**Wattage:** 2 - 60 C

**Designer:**  
E. F. Chapman

©EFC DESIGNS



CHD2908BZ



**CHD2910AN**  
**Linear Lantern Tall**  
**in Antique Nickel**  
Height: 22.5"  
Width: 9"  
Extension: 5"  
Backplate:  
9" x 20" Rectangle

**Finishes:**  
AB, AN, BZ, PN, WZ  
**Glass Options:** CG

**Socket:**  
2 - Candelabra  
**Wattage:** 2 - 60 C

**Designer:**  
E. F. Chapman

©EFC DESIGNS



CHD2910AB







**S2017AI**  
**Belden Round**  
**Sconce in Aged Iron**  
Height: 20"  
Width: 4.5"  
Extension: 6"  
Backplate:  
4.5" X 20" Rectangle

**Finishes:** AI, PN  
**Glass Options:** CG

**Socket:** Keyless  
**Wattage:** 60 T

**Designer:**  
Ian Fowler

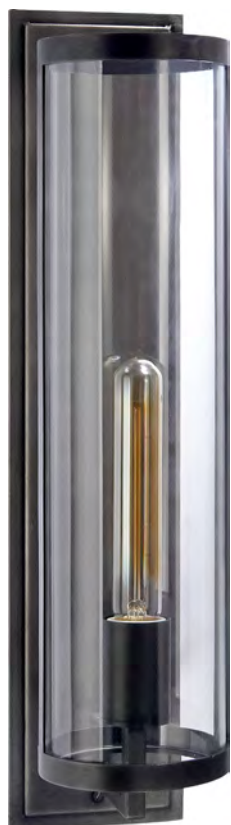

**S2017PN**



**S2015AI**  
**Belden Square**  
**Sconce in Aged Iron**  
Height: 19.75"  
Width: 4.5"  
Extension: 6.5"  
Backplate:  
4.5" x 19.75" Rectangle

**Finishes:** AI, PN  
**Glass Options:** CG

**Socket:** Keyless  
**Wattage:** 60 T

**Designer:**  
Ian Fowler



**S2015PN**



**SK2301PN**  
**Flea Market Lantern**  
**in Polished Nickel**  
Height: 18"  
Width: 11.5"  
Extension: 7"  
Backplate:  
10" x 12.25" Rectangle

**Finishes:**  
AZ, GI, OW, PN  
**Glass Options:** CG

**Socket:** Candelabra  
**Wattage:** 60 C

**Designer:**  
Suzanne Kasler

SK2301OW



SK2301GI

SK2301AZ









**CHD2165PN**  
**Darlana Wall Lantern**  
**in Polished Nickel**  
Height: 17"  
Width: 11"  
Extension: 8.5"  
Backplate:  
10" x 11.5" Rectangle

**Finishes:**  
AI, GI, OW, PN

**Socket:** Candelabra  
**Wattage:** 60 C

**Designer:**  
E. F. Chapman

©EFC DESIGNS

CHD2165OW



CHD2165GI

CHD2165AI



**CL2172BZ**  
**Soho Double**  
**Sconce in Bronze**  
 Height: 9"  
 Width: 11"  
 Extension: 4"  
 Backplate:  
 9" x 11" Rectangle

**Finishes:** BS, BZ

**Socket:** 2 - Keyless  
**Wattage:** 2 - 40 B

**Designer:**  
 Clodagh



**CL2181PN**  
**Bowery 18" Wall**  
**Sconce in Polished**  
**Nickel with**  
**Mesh Diffuser**  
 Height: 18"  
 Width: 3.5"  
 Extension: 3.75"  
 Backplate:  
 3.5" x 18" Rectangle

**Finishes:** AI, PN

**Socket:** 2 - Keyless  
**Wattage:** 2 - 40 T

**Designer:**  
 Clodagh

CL2181AI



**CL2002BZ-L  
Chelsea Sconce  
in Bronze with  
Linen Shade**  
Height: 11.5"  
Width: 5.25"  
Extension: 5"  
Backplate:  
2.5" x 4" Rectangle

**Finishes:** BZ  
**Shade Treatments:**  
L

**Shade Details:**  
5.25" x 5.25" x 8.5"

**Socket:** Keyless  
**Wattage:** 60 B

**Note:** Requires a  
Smaller Outlet Box

**Designer:**  
Clodagh



**BBL2012DW-L**  
**Plank Sconce in**  
**Dark Walnut with**  
**Linen Shade**  
Height: 15.5"  
Width: 6.5"  
Extension: 4.5"  
Backplate:  
8.5" x 6" Rectangle

**Finishes:** DW  
**Shade Treatments:** L  
**Shade Details:**  
6" x 6" x 9"

**Socket:** Keyless  
**Wattage:** 40 B

**Designer:**  
Barbara Barry



**BBL2110SS-S**  
**Framework Sconce**  
**in Soft Silver**  
**with Silk Shade**  
Height: 12.75"  
Width: 5.25"  
Extension: 7"  
Backplate: 4" Square

**Finishes:**  
BZ, PN, SB, SS  
**Shade Treatments:** S  
**Shade Details:**  
5.25" x 5.25" x 10"

**Socket:** Keyless  
**Wattage:** 40 B

**Designer:**  
Barbara Barry

**BBL2110SB-S**



**BBL2110BZ-S**



**ARN2045G**

**ARN2045PW/G**  
**Tourain Wall Sconce**  
**in Plaster White**  
**with Gild Interior**  
Height: 13"  
Width: 4.25"  
Extension: 4.5"  
Backplate: 4.25" x 6" Rectangle

**Finishes:**  
BLK, BSL, G, PW

**Socket:** Keyless  
**Wattage:** 40 T

**Designer:**  
AERIN

**ARN2045BLK/G**



**ARN2036PW**  
**Selfoss Sconce in**  
**Plaster White with**  
**Gild Interior**  
 Height: 11"  
 Width: 7"  
 Extension: 4.25"  
 Backplate:  
 4.5" x 6.25" Rectangle

**Finishes:**  
 BLK, BZ, PW

**Socket:**  
 2 - Candelabra  
**Wattage:** 2 - 40 C

**Designer:**  
 AERIN

ARN2036BLK



**ARN2020PN**  
**Irving Wall Washer**  
**in Polished Nickel**  
 Height: 6.5"  
 Width: 12.5"  
 Extension: 6.5"  
 Backplate:  
 4" x 4" Square

**Finishes:**  
 BZ, HAB, PN

**Socket:** Keyless  
**Wattage:** 60 B

**Designer:**  
 AERIN

ARN2020HAB

ARN2020BZ







**KW2070BSL**  
**Strada Small**  
**Sconce in Burnished**  
**Silver Leaf**  
 Height: 19.5"  
 Width: 8"  
 Extension: 5"  
 Backplate: 4" Round

KW2070G

KW2070AI

**Finishes:**  
 AI, BSL, G, PN

**Socket:**  
 2 - Candelabra

**Wattage:** 2 - 60 B

**Designer:**  
 Kelly Wearstler



**ARN2034PN**  
**Carbet Sconce in**  
**Polished Nickel**  
 Height: 16.25"  
 Width: 5"  
 Extension: 7.75"  
 Backplate:  
 4.25" Round

**Finishes:**  
 BZ, HAB, PN

**Socket:** Keyless

**Wattage:** 60 B

**Designer:**  
 AERIN

ARN2034HAB

ARN2034BZ



**SR2011PN**  
**Micah Sconce**  
**in Polished Nickel**  
Height: 7"  
Width: 5.5"  
Extension: 6"  
Backplate:  
3" x 7" Rectangle

SR2011AN

SR2011HAB

**Finishes:**  
AN, HAB, PN

**Socket:** Keyless  
**Wattage:** 60 B

**Designer:**  
John Rosselli



**CL2016PN-FG**  
**Primitive Sconce in**  
**Polished Nickel**  
**with Frosted Glass**  
Height: 10.5"  
Width: 5"  
Extension: 3.5"  
Backplate:  
4.5" x 10.75"  
Rectangle

CL2016BS-FG

CL2016BZ-FG

**Finishes:** BS, BZ, PN  
**Glass Options:** FG

**Socket:** Keyless  
**Wattage:** 60 B

**Designer:**  
Clodagh



**KW2060AB**  
**Precision Small  
Sconce in Antique-  
Burnished Brass**  
Height: 7.75"  
Width: 8.75"  
Extension: 3.25"  
Backplate: 5.5" Square

**Finishes:** AB, BZ, PN

**Socket:** Intermediate  
**Wattage:** 40 T

**Designer:**  
Kelly Wearstler

KW2060BZ

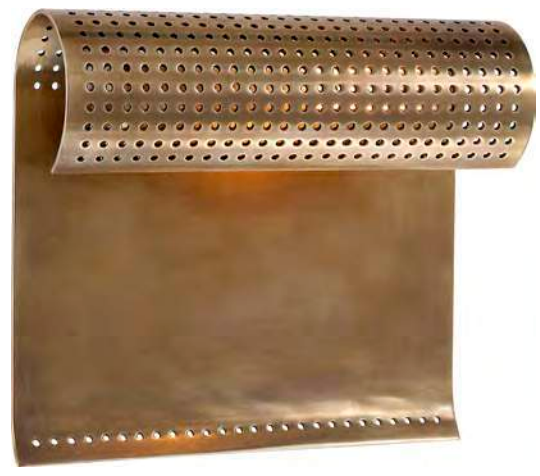

**KW2063AB**  
**Precision Double  
Sconce in Antique-  
Burnished Brass**  
Height: 8.75"  
Width: 8"  
Extension: 4"  
Backplate:  
4.25" x 7" Rectangle

**Finishes:**  
AB, BZ, PN

**Socket:**  
2 - Intermediate  
**Wattage:** 2 - 40 T

**Designer:**  
Kelly Wearstler

KW2063BZ

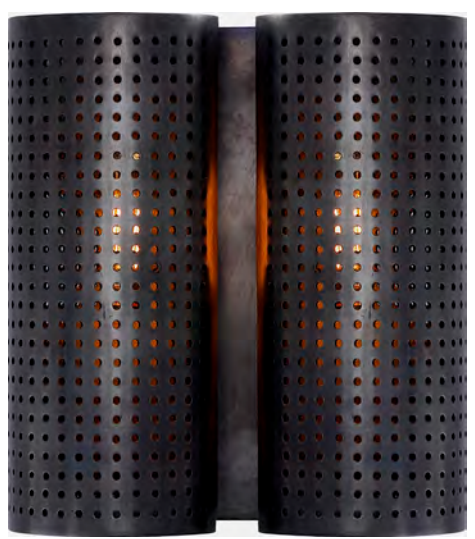

**KW2112AB-ALB**  
**Covet Tall Box Bath**  
**Sconce in Antique-**  
**Burnished Brass**  
Height: 16"  
Width: 4.25"  
Extension: 4"  
Backplate:  
4.25" x 6" Rectangle

**Finishes:**  
AB, BZ, PN  
**Shade Treatments:**  
ALB

**Socket:** Keyless  
**Wattage:** 60 T

**Designer:**  
Kelly Wearstler



**KW2115BZ-ALB**  
**Covet Wide Clip Bath**  
**Sconce in Bronze**  
Height: 9.5"  
Width: 5.25"  
Extension: 3.5"  
Backplate:  
5.25" x 9.5" Rectangle

**Finishes:**  
AB, BZ, PN  
**Shade Treatments:**  
ALB

**Socket:** Candelabra  
**Wattage:** 60 C

**Designer:**  
Kelly Wearstler

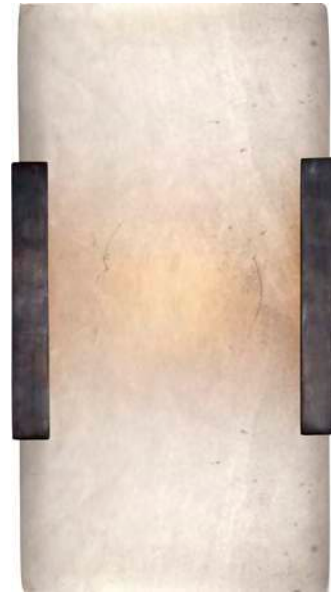

**KW2113AB-ALB**  
**Covet Short Clip Bath**  
**Sconce in Antique-**  
**Burnished Brass**  
Height: 10.75"  
Width: 5.5"  
Extension: 3.5"  
Backplate:  
5.5" x 7" Rectangle

**Finishes:**  
AB, BZ, PN  
**Shade Treatments:**  
ALB

**Socket:** Keyless  
**Wattage:** 60 B

**Designer:**  
Kelly Wearstler

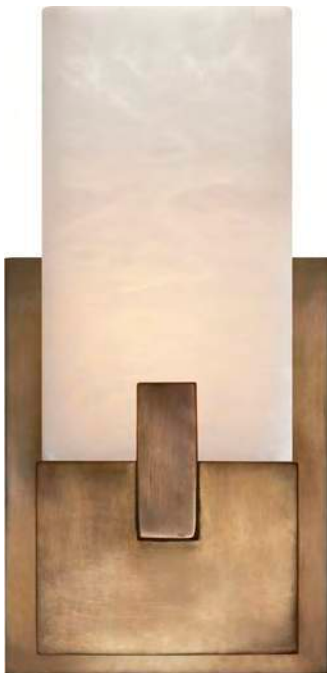

**KW2113BZ-ALB**



**TOB2711ALB**  
**Roberto Tall Wall**  
**Light in Alabaster**  
Height: 11.5"  
Width: 6"  
Extension: 4.75"  
Backplate:  
4" x 9" Rectangle

**Finishes:** ALB

**Socket:** 2 - Keyless  
**Wattage:** 2 - 40 B

**Designer:**  
Thomas O'Brien



**ARN2039PN-ALB**  
**Iveala Single Sconce**  
**in Polished Nickel**  
**with Alabaster Shade**  
Height: 12.75"  
Width: 10.5"  
Extension: 4.25"  
Backplate: 4.5" Round

**Finishes:** HAB, PN  
**Shade Treatments:**  
ALB

**Socket:** Keyless  
**Wattage:** 60 B

**Designer:**  
AERIN



**ARN2039HAB-ALB**



**ARN2043ALB**  
**Clayton Wall**  
**Sconce in Alabaster**  
Height: 12.5"  
Width: 5.25"  
Extension: 3.75"  
Backplate:  
4.75" x 12.25" Rectangle

**Finishes:** ALB, CG

**Socket:**  
2 - Candelabra  
**Wattage:** 2 - 60 B

**Designer:**  
AERIN



**ARN2043CG**



**KW2010AB-ALB**  
**Melange Sconce in**  
**Antique-Burnished**  
**Brass with Alabaster**  
 Height: 7"  
 Width: 7"  
 Extension: 3.25"  
 Backplate: 4" Round

**Finishes:** AB, BZ  
**Shade Treatments:**  
 ALB

**Socket:** Candelabra  
**Wattage:** 25 B

**Designer:**  
 Kelly Wearstler



**KW2010BZ-ALB**

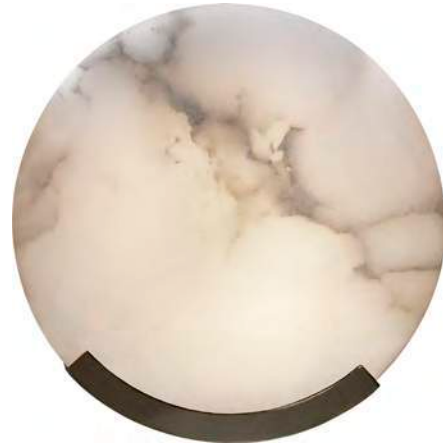

**KW2091AB/Q**  
**Halcyon Rectangle**  
**Sconce in Antique-**  
**Burnished Brass**  
**and Quartz**  
 Height: 14"  
 Width: 6.25"  
 Extension: 4.5"  
 Backplate:  
 4.5" Round

**Finishes:** AB

**Socket:** Candelabra  
**Wattage:** 60 B

**Designer:**  
 Kelly Wearstler



**KW2092AB/Q**  
**Halcyon Sconce**  
**in Antique-Burnished**  
**Brass and Quartz**  
**with Antique-Burnished**  
**Brass Shade**  
 Height: 16.5"  
 Width: 6"  
 Extension: 6"  
 Backplate:  
 3.75" x 4" Rectangle

**Finishes:** AB

**Socket:** Candelabra  
**Wattage:** 60 B

**Designer:**  
 Kelly Wearstler





**KW2090AB/Q**  
**Halcyon Round Sconce**  
**in Antique-Burnished**  
**Brass and Quartz**  
Height: 14"  
Width: 14"  
Extension: 4.75"  
Backplate: 9.5" Round

**Finishes:** AB

**Socket:**  
2 - Candelabra  
**Wattage:** 2 - 60 B

**Designer:**  
Kelly Wearstler



**FUNCTIONAL WALL**



hello

Twentieth Century  
GUNTHER SANDER, EDITOR

**SL2923AN**  
**Boston Functional**  
**Double Arm Library**  
**Light in Antique Nickel**  
 Height: 35.5"  
 Extension: 9" - 35"  
 Backplate:  
 4.75" Round

SL2923BZ

SL2923HAB

**Finishes:**  
 AN, BZ, HAB, PN  
**Shade Details:**  
 2" x 7" x 5"

**Socket:** Hi-Lo  
**Wattage:** 60 A

**Note:** Cord Cover  
 Included/Adjusts  
 Vertically Only

**Designer:**  
 E. F. Chapman

©EFC DESIGNS



**SL2922PN**  
**Boston Functional**  
**Single Arm**  
**Library Light**  
**in Polished Nickel**  
 Height: 25"  
 Extension: 9" - 25"  
 Backplate:  
 4.75" Round

SL2922AN

SL2922HAB

**Finishes:**  
 AN, BZ, HAB, PN  
**Shade Details:**  
 2" x 7" x 5"

**Socket:** Hi-Lo  
**Wattage:** 60 A

**Note:** Cord  
 Cover Included

**Designer:**  
 E. F. Chapman

©EFC DESIGNS



**S2602AN**  
**French Library Double**  
**Arm Wall Lamp**  
**in Antique Nickel**  
Width: 5.75"  
Extension: 16" - 31"  
Backplate:  
2.5" x 4.5"  
Rectangle

**Finishes:**  
AN, BZ, HAB, PN

**Socket:** Keyless  
with Line Switch  
**Wattage:** 50 Par

**Note:** Cord Cover  
Included/Requires  
Smaller Outlet Box

**Designer:**  
Studio VC

S2602BZ

S2602HAB



**S2601PN**  
**French Library**  
**Single Arm Wall Lamp**  
**in Polished Nickel**  
Width: 5.75"  
Extension: 21"  
Backplate:  
2.5" x 4.5" Rectangle

**Finishes:**  
AN, BZ, HAB, PN

**Socket:** Keyless  
with Line Switch  
**Wattage:** 50 Par

**Note:** Cord Cover  
Included/Requires  
Smaller Outlet Box

**Designer:**  
Studio VC

S2601AN

S2601HAB





**ARN2024HAB-HAB**  
**Clemente Wall Light**  
in Hand-Rubbed  
Antique Brass  
Height: 10.5"  
Width: 6.25"  
Extension: 13"  
Backplate: 6.25" Round

**Finishes:** HAB  
**Shade Treatments:**  
BLK, HAB, WHT

**Socket:** Keyless  
**Wattage:** 60 B

**Designer:**  
AERIN



**ARN2006HAB**  
**Charlton Wall Light**  
in Hand-Rubbed  
Antique Brass  
Height: 7.5" - 14.5"  
Width: 9.25"  
Extension: 12" - 19"  
Backplate: 5.25" Round

**Finishes:**  
BLK, HAB, WHT

**Socket:**  
Keyless with Toggle  
on Backplate  
**Wattage:** 60 B

**Designer:**  
AERIN



**ARN2024HAB-BLK**



**ARN2006BLK**



**ARN2024HAB-WHT**



**ARN2006WHT**



**TOB2156AN-SG**  
**Gale Library Wall**  
**Light in Antique Nickel**  
**with Seeded Glass**

Height: 21.5"  
Width: 7.5"  
Extension: 17" - 30"  
Backplate:  
4.75" Round

**Finishes:**  
AN, BZ, HAB, PN  
**Glass Options:**  
SG, WG

**Socket:** On-Off  
**Wattage:** 60 A

**Designer:**  
Thomas O'Brien

TOB2156PN-WG



TOB2156HAB-SG

TOB2156HAB-WG









**SK2115PN-NP**  
Graves Pivoting  
Sconce in Polished  
Nickel with Natural  
Paper Shade  
Height: 16.5"  
Width: 8"  
Extension: 19.5"  
Backplate:  
4" x 5.5" Rectangle

**Finishes:**  
AN, BZ, HAB, PN  
**Shade Treatments:**  
NP  
**Shade Details:**  
4.5" x 8" x 7.5"

**Socket:** Pull-Chain  
**Wattage:** 60 B

**Note:** Cord  
Cover Included

**Designer:**  
Suzanne Kasler

SK2115AN-NP



SK2115HAB-NP



SK2115BZ-NP



**ARN2003HAB-L**  
**Clarkson Double Sconce**  
 in Hand-Rubbed  
 Antique Brass with  
 Linen Shade

Height: 16"  
 Width: 21.5"  
 Extension: 11.5"  
 Backplate: 4.5" Round

**Finishes:**

BLK, HAB, WHT

**Shade Treatments:** L

**Shade Details:**

5" x 5.5" x 7.75"

**Socket:**

4 - Candelabra with  
 Toggle on Backplate

**Wattage:** 4 - 40 B

**Designer:**

AERIN



ARN2003WHT-L

**ARN2002HAB-L**  
**Frankfort Articulating Wall**  
**Light in Hand-Rubbed**  
 Antique Brass and  
 Mahogany Accents  
 with Linen Shade

Height: 22.5"  
 Width: 5.5"  
 Extension: 29.75"  
 Backplate:  
 3" x 13.5" Rectangle

**Finishes:** BLK, HAB

**Shade Treatments:** L

**Shade Details:**

5.5" x 5.5" x 15"

**Socket:**

2 - Candelabra with  
 Toggle on Backplate

**Wattage:** 2 - 40 B

**Note:** Requires a  
 Smaller Outlet Box

**Designer:**

AERIN



ARN2002BLK-L





**BBL2010PN-S**  
**Understudy Sconce**  
**in Polished Nickel**  
**with Silk Shade**

Height: 20"  
Width: 10"  
Extension: 22" - 25"  
Backplate:  
5.25" Round

**Finishes:**  
BZ, PN, SB, SS  
**Shade Treatments:** S  
**Shade Details:**  
9" x 10" x 10"

**Socket:** Keyless  
**Wattage:** 60 A

**Designer:**  
Barbara Barry

BBL2010SS-S



BBL2010SB-S



BBL2010BZ-S



**BBL2027PN-L**  
**Aspect Library Sconce**  
**in Polished Nickel with**  
**Ivory Linen Shade**

Height: 14.5"  
 Width: 6"  
 Extension: 7.5"  
 Backplate:  
 2.5" x 4.75" Rectangle

**Finishes:**  
 BZ, PN, PWT, SB, SS  
**Shade Treatments:** L  
**Shade Details:**  
 5.5" x 6" x 7.25"

**Socket:** Keyless  
**Wattage:** 60 B

**Note:** Requires a  
 Smaller Outlet Box

**Designer:**  
 Barbara Barry

BBL2027SB-L

BBL2027BZ-L



**BBL2028PN-L**  
**Aspect Small**  
**Articulating Sconce**  
**in Polished Nickel with**  
**Ivory Linen Shade**

Height: 16.25"  
 Width: 7.75"  
 Extension: 11"  
 Backplate: 4.5" Square

**Finishes:** BZ, PN,  
 PWT, SB, SS  
**Shade Treatments:** L  
**Shade Details:**  
 7.25" x 7.75" x 8.25"

**Socket:** Dimmer  
**Wattage:** 75 A

**Note:** Cord  
 Cover Included

**Designer:**  
 Barbara Barry

BBL2028SB-L

BBL2028BZ-L







**BBL2029SS-L**  
**Aspect Large**  
**Articulating Sconce**  
**in Soft Silver with**  
**Ivory Linen Shade**  
Height: 18.5"  
Width: 10"  
Extension: 13.5"  
Backplate: 4.5" Square

**Finishes:**  
BZ, PN, PWT, SB, SS  
**Shade Treatments:** L  
**Shade Details:**  
9.5" x 10" x 9.5"

**Socket:** Dimmer  
**Wattage:** 100 A

**Note:** Cord  
Cover Included

**Designer:**  
Barbara Barry

BBL2029PN-L



BBL2029SB-L

BBL2029BZ-L



**CHD5106PN-NP**  
**Chunky Swing Arm in Polished Nickel with Natural Paper Shade**  
Height: 18.25"  
Extension: 25.75"  
Backplate: 4" x 5" Rectangle

**Finishes:**  
AB, AN, BZ, PN  
**Shade Treatments:**  
L, NP  
**Shade Details:**  
10" x 12" x 7.5"

**Socket:** Dimmer  
**Wattage:** 100 A

**Note:** Cord Cover Included

**Designer:**  
E. F. Chapman

©EFC DESIGNS



**CHD5106BZ-NP**



**PT2000BC-S**  
**Architect's Swing Arm in Brushed Chrome with Silk Shade**  
Height: 13"  
Width: 8"  
Extension: 21.5"  
Backplate: 3" x 4.5" Rectangle

**Finishes:**  
BC, BZ, HAB  
**Shade Treatments:** S  
**Shade Details:**  
8" x 8" x 8"

**Socket:** Dimmer  
**Wattage:** 100 A

**Note:** Cord Cover Included

**Designer:**  
Studio VC



**PT2000HAB-S**



**TOB2201PN-NP**  
**Paulo Large Bracket**  
**Swing Arm in**  
**Polished Nickel with**  
**Natural Paper Shade**  
Height: 18"  
Width: 18"  
Extension: 33" - 51"  
Backplate:  
3.5" x 7.25" Rectangle

**Finishes:**  
BZ, HAB, PN  
**Shade Treatments:** NP  
**Shade Details:**  
15" x 17.5" x 10"

**Socket:** Dimmer  
**Wattage:** 150 A

**Note:** Cord Cover  
Included/Requires  
Smaller Outlet Box

**Designer:**  
Thomas O'Brien



**TOB2201HAB-NP**



**TOB2201BZ-NP**



**TOB2203PN-NP**  
**Paulo Small Bracket**  
**Light in Polished**  
**Nickel with Natural**  
**Paper Shade**  
Height: 16"  
Width: 11"  
Extension: 15" - 26"  
Backplate:  
3.5" x 7.25" Rectangle

**Finishes:**  
BZ, HAB, PN  
**Shade Treatments:** NP  
**Shade Details:**  
8.5" x 11" x 8.5"

**Socket:** Dimmer  
**Wattage:** 100 A

**Note:** Cord Cover  
Included/Requires  
Smaller Outlet Box

**Designer:**  
Thomas O'Brien



**TOB2203HAB-NP**



**TOB2202PN-NP**  
**Paulo Pivoting Sconce**  
**in Polished Nickel with**  
**Natural Paper Shade**  
Height: 19"  
Width: 11"  
Extension: 14.5"  
Backplate:  
3.5" x 6.5" Rectangle

**Finishes:**  
BZ, HAB, PN  
**Shade Treatments:** NP  
**Shade Details:**  
8.5" x 11" x 8.5"

**Socket:** Dimmer  
**Wattage:** 100 A

**Note:** Cord Cover  
Included/Requires  
Smaller Outlet Box

**Designer:**  
Thomas O'Brien



**TOB2202BZ-NP**





**TOB2204PN-NP**  
**Hudson Swing Arm in**  
**Polished Nickel with**  
**Natural Paper Shade**  
Height: 11"  
Width: 12"  
Extension: 13.5" - 28.5"  
Backplate:  
3" x 4.75" Rectangle

**Finishes:**  
AN, BZ, HAB, PN  
**Shade Treatments:** NP

**Socket:** On-Off  
**Wattage:** 60 A

**Note:** Cord Cover  
Included/Requires  
Smaller Outlet Box

**Designer:**  
Thomas O'Brien

TOB2204AN-NP



TOB2204HAB-NP



TOB2204BZ-NP



**S2000PN-NP**  
**Triple Swing Arm Wall**  
**Lamp in Polished**  
**Nickel with Natural**  
**Paper Shade**  
 Height: 13"  
 Extension: 18.5"  
 Backplate:  
 3.5" x 4.5" Rectangle

**Finishes:**  
 AN, BZ, HAB, PN  
**Shade Treatments:**  
 L, NP, S  
**Shade Details:**  
 8" x 11" x 8.25"

**Socket:** Dimmer  
**Wattage:** 100 A

**Note:** Cord Cover  
 Includes/Requires  
 Smaller Outlet Box

**Designer:**  
 Studio VC

S2000AN-L



S2000HAB-S

S2000BZ-NP





**CHD2154PN-NP**  
**Pimlico Swing Arm in Polished Nickel with Natural Paper Shade**  
Height: 17"  
Extension: 25"  
Backplate:  
3" x 6.5" Rectangle

**Finishes:**  
AB, AN, PN  
**Shade Treatments:**  
LCC, NP  
**Shade Details:**  
7" x 12" x 9"

**Socket:** Hi-Lo  
**Wattage:** 60 A

**Note:** Cord  
Cover Included

**Designer:**  
E. F. Chapman

©EFC DESIGNS



**CHD2154AB-LCC**



**CHD5101PN-SC**  
**Dorchester Swing Arm in Polished Nickel with Silk Crown Shade**  
Height: 15"  
Extension: 22"  
Backplate:  
2.25" x 4.5" Rectangle

**Finishes:**  
AB, AN, PN  
**Shade Treatments:**  
B, C  
**Shade Details:**  
6" x 10" x 8"

**Socket:** Hi-Lo  
**Wattage:** 100 A

**Note:** Cord  
Cover Included

**Designer:**  
E. F. Chapman

©EFC DESIGNS



**CHD5101AB-SC**



**SK2109GI-NP**  
**Griffith Swing Arm**  
**in Gilded Iron with**  
**Natural Paper Shade**

Height: 16"  
 Width: 10"  
 Extension: 24"  
 Backplate: 5" Square

**Finishes:** AI, GI  
**Shade Treatments:** NP  
**Shade Details:**  
 7.25" x 10" x 8"

**Socket:** Dimmer  
**Wattage:** 100 A

**Note:** Cord  
 Cover Included

**Designer:**  
 Suzanne Kasler



SK2109AI-NP



**S2500AN-NP**  
**Primitive Swing Arm**  
**in Antique Nickel with**  
**Natural Paper Shade**

Height: 14"  
 Width: 12"  
 Extension: 18.25"  
 Backplate:  
 3.5" x 5" Rectangle

**Finishes:** AN, HAB  
**Shade Treatments:**  
 L, NP  
**Shade Details:**  
 5" x 12" x 8.75"

**Socket:** Hi-Lo  
**Wattage:** 75 A

**Note:** Cord Cover  
 Included/Requires  
 Smaller Outlet Box

**Designer:**  
 Studio VC



S2500HAB-NP



**92000DHAB-L**  
**Classic Swing**  
**Arm Wall Lamp in**  
**Hand-Rubbed**  
**Antique Brass with**  
**Linen Shade**  
Height: 11"  
Width: 12"  
Extension: 25"  
Backplate: 4.5" Square

**Finishes:** AN, BZ,  
HAB, PN, WHT  
**Shade Treatments:** L  
**Shade Details:**  
6" x 12" x 7"

**Socket:** Dimmer  
**Wattage:** 75 A

**Note:** Cord  
Cover Included

**Designer:**  
Studio VC



**92000DBZ-L**



**AH2012NB-S**  
**Gene Swing Arm in**  
**Natural Brass**  
**with Silk Shade**  
Height: 15"  
Width: 12"  
Extension: 12.75" -19.5"  
Backplate:  
3.5" x 5" Rectangle

**Finishes:**  
BN, GM, NB, PN  
**Shade Treatments:** S  
**Shade Details:**  
7" x 12" x 9"

**Socket:** Hi-Lo  
**Wattage:** 100 A

**Note:** Cord  
Cover Included

**Designer:**  
Alexa Hampton



**AH2012GM-S**





**CHD5102AB-NP**  
**Dorchester Double**  
**Backplate Swing Arm**  
**in Antique-Burnished**  
**Brass with Natural**  
**Paper Shade**  
Height: 27"  
Extension: 24"  
Backplate:  
(2) 2.5" x 4" Rectangle

**Finishes:**

AB, AN, PN

**Shade Treatments:**

B, NP

**Shade Details:**

6" x 10" x 7"

**Socket:** Hi-Lo

**Wattage:** 100 A

**Note:**

Cord Cover Included

**Designer:**

E. F. Chapman

©EFC DESIGNS

**S2010PN-NP**  
**Candlestick Swing**  
**Arm in Polished**  
**Nickel with**  
**Natural Paper Shade**  
Height: 16"  
Extension: 19"  
Backplate:  
5" Round

**Finishes:**  
AN, BZ, HAB, PN  
**Shade Treatments:**  
NP, S  
**Shade Details:**  
5" x 11" x 8.25"

**Socket:** Dimmer  
**Wattage:** 60 A

**Note:** Cord  
Cover Included

**Designer:**  
Studio VC



**S2010HAB-NP**



**SL2920AN-L**  
**Boston Swing Arm**  
**in Antique Nickel**  
**with Linen Shade**  
Height: 13"  
Extension: 13"  
Backplate: 5" Round

**Finishes:**  
AN, BZ, HAB, PN  
**Shade Treatments:**  
AN, BZ, HAB, L, PN  
**Shade Details:**  
8" x 12" x 7"

**Socket:** Hi-Lo  
**Wattage:** 60 A

**Note:** Cord  
Cover Included

**Designer:**  
E. F. Chapman

©EFC DESIGNS



**SL2920HAB-L**



**SL2800HAB-S**  
**Classic Swing Arm**  
**Sconce in Hand-Rubbed**  
**Antique Brass with**  
**Silk Shade**  
 Height: 17.25"  
 Width: 11"  
 Extension: 19"  
 Backplate: 4.25" Round

**Finishes:**  
 AN, BZ, HAB, PN  
**Shade Treatments:** S  
**Shade Details:**  
 8" x 11" x 8.5"

**Socket:** Dimmer  
**Wattage:** 100 A

**Note:** Cord  
 Cover Included

**Designer:**  
 E. F. Chapman

©EFC DESIGNS



SL2800BZ-S



**SL2817PN-NP**  
**Classic Two-Light**  
**Sconce in Polished**  
**Nickel with Natural**  
**Paper Shade**  
 Height: 17"  
 Width: 13"  
 Extension: 8.5"  
 Backplate: 4.5" Round

**Finishes:**  
 AN, BZ, HAB, PN  
**Shade Treatments:** NP  
**Shade Details:**  
 11" x 13" x 7.5"  
 Oval

**Socket:**  
 2 - Candelabra  
**Wattage:** 2 - 60 B

**Note:** Cord  
 Cover Included

**Designer:**  
 E. F. Chapman

©EFC DESIGNS



SL2817HAB-NP









**82034PN**  
**Studio Swing Arm**  
**Wall Light in**  
**Polished Nickel**  
Height: 4.5"  
Extension: 24"  
Backplate: 4.5" Square

**82034AN**

**Finishes:**  
AN, BZ, HAB, PN

**Socket:** Dimmer  
**Wattage:** 40 J

**Note:** Cord Cover and  
Bulb Included

**Designer:**  
Studio VC

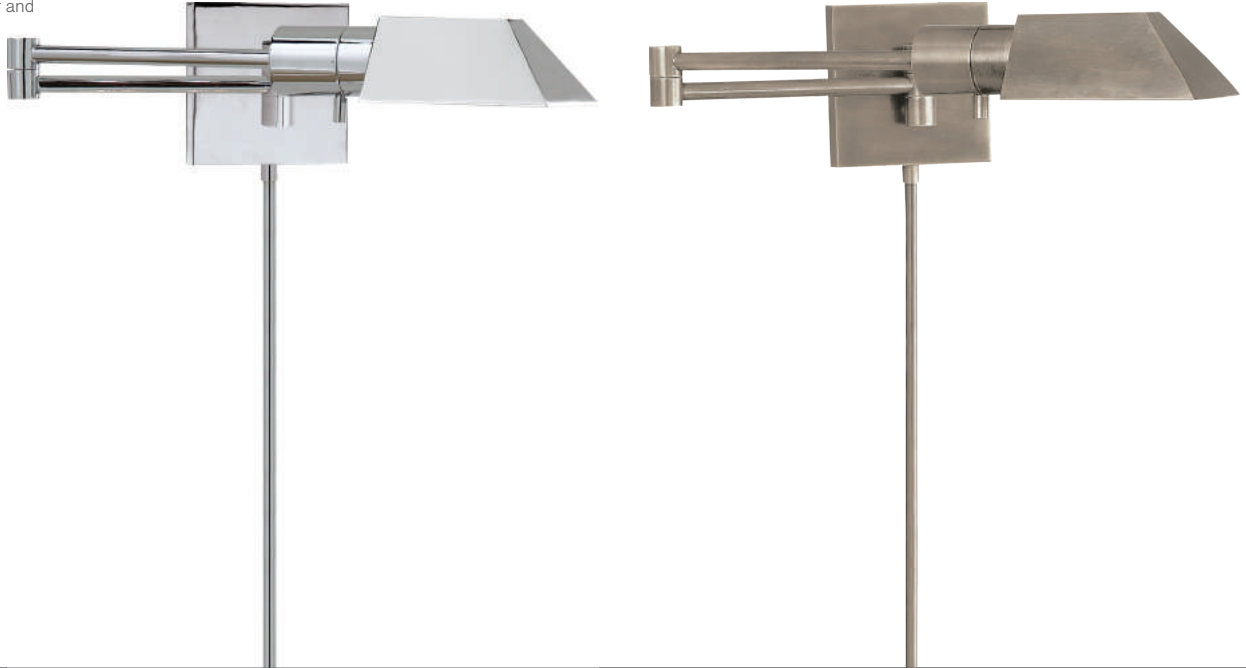

**82034HAB**

**82034BZ**



**92025PN**  
**Studio Swing Arm**  
**Wall Light in**  
**Polished Nickel**  
Height: 4.5"  
Extension: 25"  
Backplate:  
4.5" Square

**Finishes:**  
AN, BZ, HAB, PN

**Socket:** Dimmer  
**Wattage:** 60 T

**Note:** Cord  
Cover Included

**Designer:**  
Studio VC

92025AN



92025HAB

92025BZ



SL2920PN/SLG-PN

**Boston Swing Arm  
in Polished Nickel  
with SLG Shade**

Height: 5"  
Extension: 13"  
Backplate: 5" Round

**Finishes:**

AN, BZ, HAB, PN

**Shade Treatments:**

AN, BZ, HAB, L, PN

**Shade Details:**

3.5" x 7" SLG Round

**Socket:** Hi-Lo

**Wattage:**

60 A

**Note:** Cord  
Cover Included

**Designer:**

E. F. Chapman

©EFC DESIGNS

SL2920AN/SLG-AN



SL2920HAB/SLG-HAB



SL2920BZ/SLG-BZ



**CHD2150PN-PN**  
**Pimlico Double**  
**Swing Arm in Polished**  
**Nickel with Polished**  
**Nickel Shade**  
 Height: 16"  
 Extension: 28"  
 Backplate:  
 3" x 6.5" Rectangle

**Finishes:**  
 AB, AN, PN  
**Shade Treatments:**  
 AB, AN, PN

**Socket:** Hi-Lo  
**Wattage:** 60 A

**Note:** Cord  
 Cover Included

**Designer:**  
 E. F. Chapman

©EFC DESIGNS



CHD2150AB-AB



**SL2975PN-PN**  
**Yoke Suspended**  
**Sconce in Polished**  
**Nickel with Polished**  
**Nickel Shade**  
 Height: 10.25"  
 Width: 5"  
 Extension: 9.5"  
 Backplate:  
 4.5" Round

**Finishes:**  
 AN, BZ, HAB, PN  
**Shade Treatments:**  
 AN, BZ, HAB, PN, WG

**Socket:** Keyless  
**Wattage:** 60 A

**Note:** Shade is  
 White Inside

**Designer:**  
 E. F. Chapman

©EFC DESIGNS



SL2975HAB-HAB



**CL2170PN**  
**Noho Double**  
**Torchiere Sconce**  
**in Polished Nickel**  
Height: 5.5"  
Width: 5.5"  
Extension: 7" - 14"  
Backplate:  
3.5" x 5.5" Rectangle

**Finishes:** BC, BZ, PN  
**Shade Details:** 4" x 6"

**Socket:** Keyless  
**Wattage:** 60 B

**Note:** Switch is On  
the Back Plate

**Designer:**  
Clodagh

CL2170BC



**S2650PN-PN**  
**Swivel Head**  
**Wall Lamp in**  
**Polished Nickel**  
Height: 14"  
Width: 8"  
Extension: 9.5"  
Backplate: 4" Square

**Finishes:**  
AN, BZ, HAB, PN  
**Shade Treatments:**  
AN, BZ, HAB, PN  
**Shade Details:**  
4" x 8" x 5"

**Socket:** Hi-Lo  
**Wattage:** 60 A

**Note:** Cord  
Cover Included

**Designer:**  
Studio VC

S2650AN-AN



**PICTURE WALL**

AH2701GM



**AH2700PN**  
**Dean 9" Picture Light**  
**in Polished Nickel**  
 Height: 5"  
 Width: 10.5"  
 Extension: 10"  
 Backplate:  
 2.75" x 4.5" Rectangle

**Finishes:**  
 BN, GM, NB, PN

**Socket:** Keyless  
**Wattage:** 40 T

**Designer:**  
 Alexa Hampton



AH2700BN



AH2700NB



AH2700GM



**AH2701GM**  
**Dean 12" Picture**  
**Light in Gun Metal**  
 Height: 5"  
 Width: 13.5"  
 Extension: 10"  
 Backplate:  
 2.75" x 4.5" Rectangle

**Finishes:**  
 BN, GM, NB, PN

**Socket:** Keyless  
**Wattage:** 40 T

**Designer:**  
 Alexa Hampton



AH2701BN

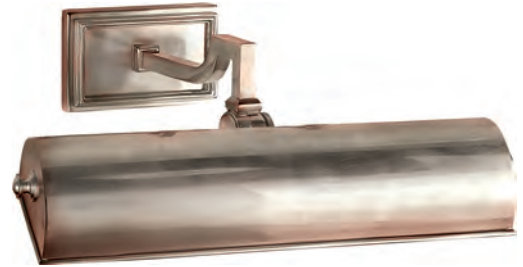

**AH2702NB**  
**Dean 18" Picture Light**  
**in Natural Brass**  
 Height: 5"  
 Width: 19.5"  
 Extension: 10"  
 Backplate:  
 2.75" x 12" Rectangle

**Finishes:**  
 BN, GM, NB, PN

**Socket:** 2 - Keyless  
**Wattage:** 2 - 40 T

**Designer:**  
 Alexa Hampton



**AH2703PN**  
**Dean 24" Picture Light**  
**in Polished Nickel**  
 Height: 5"  
 Width: 25.5"  
 Extension: 10"  
 Backplate:  
 2.75" x 18" Rectangle

**Finishes:**  
 BN, GM, NB, PN

**Socket:** 2 - Keyless  
**Wattage:** 2 - 40 T

**Designer:**  
 Alexa Hampton



**General Note:** Dean Collection -  
 Portable: Switch on Cord



**TOB2604PN**  
**Library 10" Picture Light**  
**in Polished Nickel**  
 Height: 4"  
 Width: 10.75"  
 Extension: 5"  
 Backplate:  
 2.75" x 10.75" Rectangle

**Finishes:** BZ, HAB, PN

**Socket:** Keyless  
**Wattage:** 40 T

**Designer:**  
 Thomas O'Brien



TOB2604HAB



TOB2604BZ

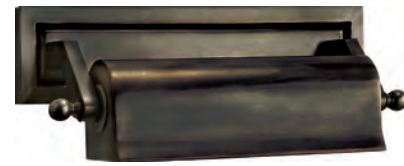

**TOB2605HAB**  
**Library 16" Picture**  
**Light in Hand-Rubbed**  
**Antique Brass**  
 Height: 4"  
 Width: 17.5"  
 Extension: 5"  
 Backplate:  
 2.75" x 17" Rectangle

**Finishes:** BZ, HAB, PN

**Socket:** 2 - Keyless  
**Wattage:** 2 - 40 T

**Designer:**  
 Thomas O'Brien



**TOB2606PN**  
**Library 22" Picture Light**  
**in Polished Nickel**  
 Height: 4"  
 Width: 23.5"  
 Extension: 5"  
 Backplate:  
 2.75" x 23" Rectangle

**Finishes:** BZ, HAB, PN

**Socket:** 2 - Keyless  
**Wattage:** 2 - 40 T

**Designer:**  
 Thomas O'Brien



**General Note:** Library Collection -  
 Cord Cover Included/Requires Smaller Outlet Box

**TOB2000PN**  
**Academy Map Light**  
**in Polished Nickel**  
 Height: 4"  
 Width: 9"  
 Extension: 12.5" - 16.5"  
 Backplate: 4" Square

**Finishes:** BZ, HAB, PN

**Socket:** Keyless  
**Wattage:** 40 T

**Note:** Portable: Switch  
 on Cord 12" from  
 Backplate/Cannot  
 be Hard-Wired

**Designer:**  
 Thomas O'Brien



TOB2000BZ



**SL2704PN**  
**8" Cabinet Maker's Picture Light in Polished Nickel**  
 Height: 3.5"  
 Width: 8"  
 Extension: 8.25"  
 Backplate: 2.75" x 4.5" Rectangle

**Finishes:**  
 AN, BZ, HAB, PN

**Socket:** Keyless  
**Wattage:** 25 T

**Designer:**  
 E. F. Chapman

©EFC DESIGNS



SL2704AN



SL2704HAB



SL2704BZ



**SL2705BZ**  
**18" Cabinet Maker's Picture Light in Bronze**  
 Height: 3.5"  
 Width: 18"  
 Extension: 8.25"  
 Backplate: 2.75" x 4.5" Rectangle

**Finishes:**  
 AN, BZ, HAB, PN

**Socket:** 2 - Keyless  
**Wattage:** 2 - 25 T

**Designer:**  
 E. F. Chapman

©EFC DESIGNS



SL2705HAB



**SL2706AN**  
**24" Cabinet Maker's Picture Light in Antique Nickel**  
 Height: 3.5"  
 Width: 24"  
 Extension: 8.25"  
 Backplate: (2) 2.75" x 4.5" Rectangle

**Finishes:**  
 AN, BZ, HAB, PN

**Socket:** 2 - Keyless  
**Wattage:** 2 - 25 T

**Designer:**  
 E. F. Chapman

©EFC DESIGNS



**SL2707HAB**  
**30" Cabinet Maker's Picture Light in Hand-Rubbed Antique Brass**  
 Height: 3.5"  
 Width: 30"  
 Extension: 8.25"  
 Backplate: (2) 2.75" x 4.5" Rectangle

**Finishes:**  
 AN, BZ, HAB, PN

**Socket:** 4 - Keyless  
**Wattage:** 4 - 25 T

**Designer:**  
 E. F. Chapman

©EFC DESIGNS



**General Note:** Cabinet Maker's Collection - Requires Smaller Outlet Box

**SL2701PN**  
**Frame Makers**  
**8" Picture Light in**  
**Polished Nickel**  
 Height: 1.5"  
 Width: 8"  
 Extension: 9" - 12"

**Finishes:**  
 AN, BZ, HAB, PN

**Socket:** Keyless  
**Wattage:** 25 T

**Designer:**  
 E. F. Chapman

©EFC DESIGNS

SL2701HAB

SL2701BZ



**SL2702AN**  
**Frame Makers**  
**18" Picture Light in**  
**Antique Nickel**  
 Height: 1.5"  
 Width: 18"  
 Extension: 9" - 12"

**Finishes:**  
 AN, BZ, HAB, PN

**Socket:** 2 - Keyless  
**Wattage:** 2 - 25 T

**Designer:**  
 E. F. Chapman

©EFC DESIGNS

SL2702HAB

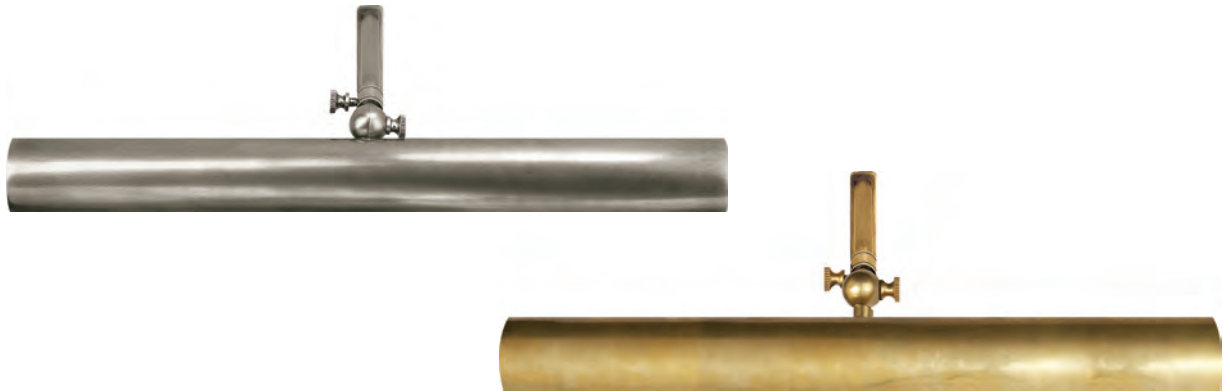

**SL2703PN**  
**Frame Makers**  
**24" Picture Light in**  
**Polished Nickel**  
 Height: 1.5"  
 Width: 24"  
 Extension: 9" - 12"

**Finishes:**  
 AN, BZ, HAB, PN

**Socket:** 2 - Keyless  
**Wattage:** 2 - 25 T

**Designer:**  
 E. F. Chapman

©EFC DESIGNS



**SL2708HAB**  
**Frame Makers**  
**30" Picture Light in**  
**Hand-Rubbed**  
**Antique Brass**  
 Height: 1.5"  
 Width: 30"  
 Extension: 9" - 12"

**Finishes:**  
 AN, BZ, HAB, PN

**Socket:** 4 - Keyless  
**Wattage:** 4 - 25 T

**Designer:**  
 E. F. Chapman

©EFC DESIGNS



**General Note:** Frame Maker Collection -  
 Portable: Switch on Cord 12" from Arm/Cannot be Hard-Wired



**CHD5117PN**  
**Dorchester 8" Picture**  
**Light in Polished Nickel**  
 Height: 4.5"  
 Width: 8"  
 Extension: 9.5"  
 Backplate:  
 2.5" x 4.5" Rectangle

**Finishes:**  
 AB, AN, BZ, PN  
**Shade Details:**  
 8" x 3.5" x 2"

**Socket:** Keyless  
**Wattage:** 40 T

**Designer:** E. F. Chapman

©EFC DESIGNS



CHD5117AB



CHD5117AN



CHD5117BZ



**CHD5137AN**  
**Dorchester 18" Picture**  
**Light in Antique Nickel**  
 Height: 4.5"  
 Width: 18"  
 Extension: 9.5"  
 Backplate:  
 4.5" x 14.5" Rectangle

**Finishes:**  
 AB, AN, BZ, PN  
**Shade Details:**  
 18" x 3.5" x 2"

**Socket:** 2 - Keyless  
**Wattage:** 2 - 40 T

**Designer:** E. F. Chapman

©EFC DESIGNS



CHD5137AB



**CHD5147PN**  
**Dorchester 24" Picture**  
**Light in Polished Nickel**  
 Height: 4.5"  
 Width: 24"  
 Extension: 9.5"  
 Backplate:  
 4.5" x 18.5" Rectangle

**Finishes:**  
 AB, AN, BZ, PN  
**Shade Details:**  
 24" x 3.5" x 2"

**Socket:** 2 - Keyless  
**Wattage:** 2 - 40 T

**Designer:** E. F. Chapman

©EFC DESIGNS



**CHD5148AB**  
**Dorchester 30" Picture**  
**Light in Antique-**  
**Burnished Brass**  
 Height: 4.5"  
 Width: 30"  
 Extension: 9.5"  
 Backplate: 4.5" x 22"  
 Rectangle

**Finishes:** AB, AN, BZ, PN  
**Shade Details:**  
 30" x 3.5" x 2"

**Socket:** 4 - Keyless  
**Wattage:** 4 - 25 T

**Designer:** E. F. Chapman

©EFC DESIGNS



**General Note:** Dorchester Collection -  
 Portable: Switch on Cord 12" From Fixture

**TOB2020PN**  
**David 7" Art Light**  
**in Polished Nickel**  
 Height: 3.75"  
 Width: 7"  
 Extension: 5.75"  
 Backplate:  
 3" x 3.75" Rectangle

**Finishes:**  
 BZ, HAB, PN

**Socket:** Keyless  
**Wattage:** 40 B

**Designer:**  
 Thomas O'Brien

TOB2020HAB

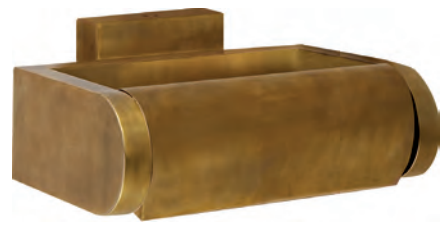

**TOB2021HAB**  
**David 12" Art Light**  
**in Hand-Rubbed**  
**Antique Brass**  
 Height: 3.75"  
 Width: 12"  
 Extension: 5.75"  
 Backplate:  
 6" x 3.75" Rectangle

**Finishes:**  
 BZ, HAB, PN

**Socket:** Keyless  
**Wattage:** 40 T

**Designer:**  
 Thomas O'Brien

TOB2021BZ/HAB



**TOB2019BZ/HAB**  
**David 18" Art Light**  
**in Bronze with**  
**Hand-Rubbed Antique**  
**Brass Shade**  
 Height: 4"  
 Width: 18"  
 Extension: 6"  
 Backplate: 4" x 6"  
 Rectangle

**Finishes:**  
 BZ, HAB, PN

**Socket:** 2 - Keyless  
**Wattage:** 2 - 40 T

**Designer:**  
 Thomas O'Brien

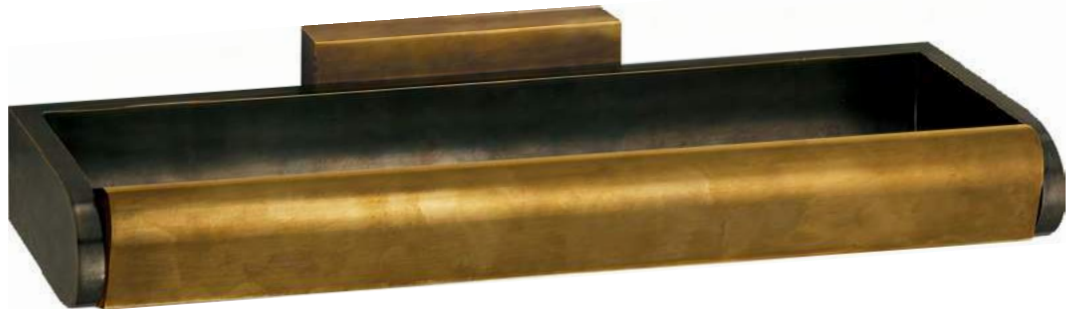

TOB2019PN



**General Note:** David Collection -  
 Requires Smaller Outlet Box

**TOB2023HAB/BZ**  
**David 24" Art Light**  
**in Hand-Rubbed**  
**Antique Brass with**  
**Bronze Shade**  
Height: 3.75"  
Width: 24"  
Extension: 5.75"  
Backplate:  
3.75" x 6" Rectangle

**Finishes:**  
BZ/HAB, HAB,  
HAB/BZ, PN

**Socket:** 3 - Keyless  
**Wattage:** 3 - 40 T

**Note:** Requires  
Smaller Outlet Box

**Designer:**  
Thomas O'Brien



**SP2704HAB**  
**McClain 30" Picture**  
**Light in Hand-Rubbed**  
**Antique Brass**  
Height: 11" - 15"  
Width: 30"  
Extension: 9.5" - 14"

**Finishes:** BZ, HAB, PN

**Socket:** 4 - Candelabra  
**Wattage:** 4 - 25 B

**Note:**  
Portable: Switch on  
Cord 12" From  
Backplate/Cannot  
be Hard-Wired

**Designer:**  
J. Randall Powers





**SP2701PN**  
**McClain 12" Picture**  
**Light in Polished Nickel**  
Height: 11" - 15"  
Width: 12"  
Extension: 9.5" - 14"

**Finishes:** BZ, HAB, PN

**Socket:** 2 - Candelabra  
**Wattage:** 2 - 25 B

**Designer:**  
J. Randall Powers

**SP2701BZ**



**SP2702HAB**  
**McClain 18" Picture**  
**Light in Hand-Rubbed**  
**Antique Brass**  
Height: 11" - 15"  
Width: 18"  
Extension: 9.5" - 14"

**Finishes:**  
BZ, HAB, PN

**Socket:**  
2 - Candelabra  
**Wattage:** 2 - 25 B

**Designer:**  
J. Randall Powers



**SP2706BZ**  
**McClain 42" Picture**  
**Light in Bronze**  
Height: 11" - 15"  
Width: 42"  
Extension: 9.5" - 14"

**Finishes:**  
BZ, HAB, PN

**Socket:** 4 - Candelabra  
**Wattage:** 4 - 25 B

**Designer:**  
J. Randall Powers



**General Note:** McClain Collection -  
Portable: Switch on Cord 12" From Backplate/Cannot be Hard-Wired

**BATH WALL**

TOB2185PN-WG



**TOB2184PN-WG**  
**Calliope Short Bath**  
**Light in Polished Nickel**  
**with White Glass**

Height: 11.5"  
Width: 4"  
Extension: 4"  
Backplate:  
4" x 10.5" Rectangle

**Finishes:**  
BZ, HAB, PN  
**Glass Options:** WG

**Socket:** Keyless  
**Wattage:** 60 B

**Designer:**  
Thomas O'Brien

TOB2184HAB-WG

TOB2184BZ-WG



**TOB2185PN-WG**  
**Calliope Tall Bath**  
**Light in Polished Nickel**  
**with White Glass**

Height: 20.5"  
Width: 4"  
Extension: 4"  
Backplate:  
4" x 19" Rectangle

**Finishes:**  
BZ, HAB, PN  
**Glass Options:** WG

**Socket:** 2 - Keyless  
**Wattage:** 2 - 60 B

**Designer:**  
Thomas O'Brien

TOB2185HAB-WG

TOB2185BZ-WG



**TOB2140PN-FG**  
**Dresser Short Glass**  
**Rod Light in**  
**Polished Nickel with**  
**Frosted Glass Liner**  
Height: 10.75"  
Width: 5"  
Extension: 3.5"  
Backplate:  
5" x 10.75" Rectangle

**Finishes:**  
AN, BZ, HAB, PN  
**Glass Options:** FG

**Socket:** Keyless  
**Wattage:** 60 B

**Designer:**  
Thomas O'Brien

**TOB2140HAB-FG**

**TOB2140BZ-FG**



**TOB2141PN-FG**  
**Dresser Long Glass**  
**Rod Light in Polished**  
**Nickel with Frosted**  
**Glass Liner**  
Height: 18"  
Width: 5"  
Extension: 3.5"  
Backplate:  
5" x 18" Rectangle

**Finishes:**  
AN, BZ, HAB, PN  
**Glass Options:** FG

**Socket:** 2 - Keyless  
**Wattage:** 2 - 60 B

**Designer:**  
Thomas O'Brien

**TOB2141HAB-FG**

**TOB2141BZ-FG**





**TOB2030PN-WG**  
**Keeley Short**  
**Pivoting Sconce in**  
**Polished Nickel**  
**with White Glass**  
Height: 12"  
Width: 3.5"  
Extension: 6.5"  
Backplate:  
3.5" x 5.75"

**Finishes:**  
BZ, CH, HAB, PN  
**Glass Options:** WG

**Socket:** Keyless  
**Wattage:** 60 T

**Note:** Requires a  
Smaller Outlet Box

**Designer:**  
Thomas O'Brien



**TOB2030HAB-WG**



**TOB2030BZ-WG**



**TOB2031PN-WG**  
**Keeley Tall**  
**Pivoting Sconce in**  
**Polished Nickel**  
**with White Glass**  
Height: 20.75"  
Width: 3.5"  
Extension: 6.5"  
Backplate:  
3.5" x 20.75"  
Rectangle

**Finishes:**  
BZ, CH, HAB, PN  
**Glass Options:** WG

**Socket:** 2 - Keyless  
**Wattage:** 2 - 60 T

**Note:** Requires a  
Smaller Outlet Box

**Designer:**  
Thomas O'Brien



**TOB2031HAB-WG**



**TOB2031BZ-WG**



**TOB2016PN**  
**Greenwich Sconce**  
**in Polished Nickel**  
**with White Glass**  
 Height: 10.5"  
 Width: 4.25"  
 Extension: 4"  
 Backplate:  
 3" x 8" Rectangle

**Finishes:**  
 AN, BZ/HAB, PN  
**Glass Options:** WG  
**Shade Details:** 2" x 8"

**Socket:** Keyless  
**Wattage:** 60 T

**Note:** Requires a  
 Smaller Outlet Box

**Designer:**  
 Thomas O'Brien

TOB2016BZ/HAB

TOB2016AN



**TOB2062CH-WG**  
**Selecta Long**  
**Sconce in Chrome**  
**with White Glass**  
 Height: 21.75"  
 Width: 4.75"  
 Extension: 3.25"  
 Backplate:  
 4.75" x 21.75"  
 Rectangle

**Finishes:**  
 BZ, BZ/HAB, CH, PN  
**Glass Options:** WG

**Socket:** 2 - Keyless  
**Wattage:** 2 - 60 T

**Designer:**  
 Thomas O'Brien

TOB2062BZ/HAB-WG

TOB2062BZ-WG







**CHD1553PN-FG**  
**Oxford 24" Bath Sconce**  
**in Polished Nickel with**  
**Frosted Glass**

Height: 24"  
Width: 4.25"  
Extension: 4"  
Backplate: 4.25" x 24"

**Finishes:**

AB, AN, BZ, CH, PN  
**Glass Options:** FG

**Socket:** 3 - Keyless

**Wattage:** 3 - 60 T

**Note:** Requires a  
Smaller Outlet Box

**Designer:**

E. F. Chapman

©EFC DESIGNS

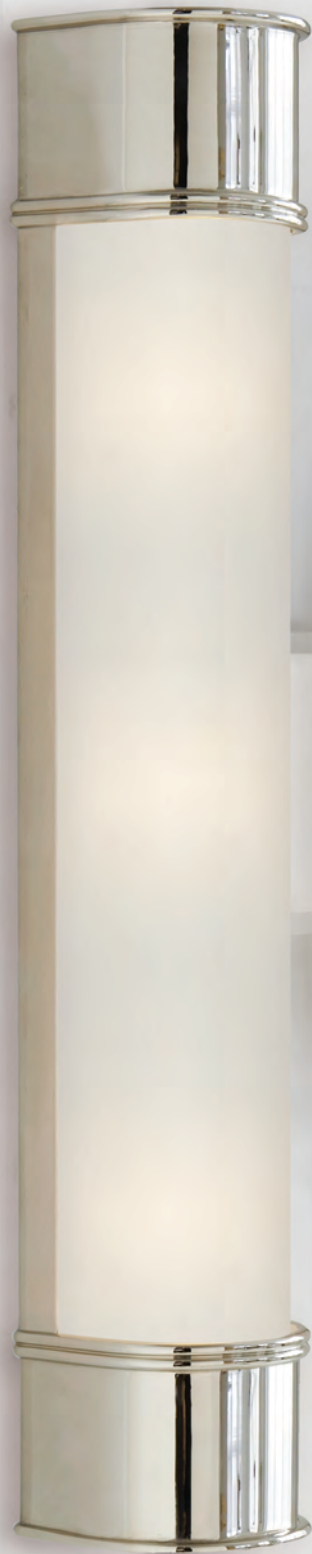

**CHD1550PN-FG**  
**Oxford 8" Bath Sconce**  
**in Polished Nickel**  
**with Frosted Glass**

Height: 8.5"  
Width: 3"  
Extension: 4"  
Backplate:  
3" x 8.5" Rectangle

**Finishes:**  
AB, AN, BZ, CH, PN  
**Glass Options:** FG

**Socket:** Keyless  
**Wattage:** 60 B

**Note:** Requires a  
Smaller Outlet Box

**Designer:**  
E. F. Chapman

©EFC DESIGNS



**CHD1550AB-FG**



**CHD1550BZ-FG**



**CHD1551PN-FG**  
**Oxford 12" Bath Sconce**  
**in Polished Nickel**  
**with Frosted Glass**

Height: 12"  
Width: 3.75"  
Extension: 4"  
Backplate:  
3.75" x 12" Rectangle

**Finishes:**  
AB, AN, BZ, CH, PN  
**Glass Options:** FG

**Socket:** Keyless  
**Wattage:** 60 B

**Note:** Requires a  
Smaller Outlet Box

**Designer:**  
E. F. Chapman

©EFC DESIGNS



**CHD1551AB-FG**



**CHD1551BZ-FG**



**CHD1552PN-FG**  
**Oxford 18" Bath Sconce**  
**in Polished Nickel**  
**with Frosted Glass**

Height: 18"  
Width: 4.25"  
Extension: 4"  
Backplate:  
4.25" x 18" Rectangle

**Finishes:**  
AB, AN, BZ, CH, PN  
**Glass Options:** FG

**Socket:** 2 - Keyless  
**Wattage:** 2 - 60 B

**Note:** Requires a  
Smaller Outlet Box

**Designer:**  
E. F. Chapman

©EFC DESIGNS



**CHD1552AB-FG**



**CHD1552AN-FG**



**CHD1560PN-WG**  
**Carew Small Sconce**  
**in Polished Nickel**  
**with White Glass**  
Height: 12"  
Width: 4.5"  
Extension: 3"  
Backplate: 3.5" x 11.25"  
Decorative

**Finishes:** AB, BZ, PN

**Socket:** Candelabra  
**Wattage:** 60 C

**Designer:**  
E. F. Chapman

©EFC DESIGNS

CHD1560AB-WG

CHD1560BZ-WG



**CHD1561PN-WG**  
**Carew Medium Sconce**  
**in Polished Nickel**  
**with White Glass**  
Height: 18"  
Width: 4.5"  
Extension: 3"  
Backplate: 3.5" x 17.25"  
Decorative

**Finishes:** AB, BZ, PN

**Socket:** Candelabra  
**Wattage:** 60 C

**Designer:**  
E. F. Chapman

©EFC DESIGNS

CHD1561AB-WG

CHD1561BZ-WG



**CHD1562PN-WG**  
**Carew Large Sconce**  
**in Polished Nickel**  
**with White Glass**  
Height: 24"  
Width: 4.5"  
Extension: 3"  
Backplate: 3.5" x 23.25"  
Decorative

**Finishes:** AB, BZ, PN

**Socket:** 2 - Candelabra  
**Wattage:** 2 - 60 C

**Designer:**  
E. F. Chapman

©EFC DESIGNS



**CHD1562AB-WG**



**CHD1562BZ-WG**



**CHD1563PN-WG**  
**Carew Linear Sconce**  
**in Polished Nickel**  
**with White Glass**  
Height: 24"  
Width: 4.5"  
Extension: 3"  
Backplate: 4" x 19"  
Decorative

**Finishes:** AB, BZ, PN

**Socket:**  
2 - Candelabra  
**Wattage:** 2 - 60 C

**Designer:**  
E. F. Chapman

©EFC DESIGNS



**CHD1563AB-WG**



**CHD1563BZ-WG**



**CHD2359PN-WG**  
Ruhlmann Linear  
Bath Sconce in  
Polished Nickel  
with White Glass  
Height: 18.5"  
Width: 4.75"  
Extension: 4"  
Backplate:  
4.5 x 13.5" Square

**Finishes:**  
AB, AN, BZ, PN  
**Glass Options:** WG

**Socket:** 2 - Keyless  
**Wattage:** 2 - 60 T

**Designer:**  
E. F. Chapman

©EFC DESIGNS

CHD2359AB-WG



CHD2359BZ-WG



**AH2023PN-WG**  
Basil Small  
Linear Sconce in  
Polished Nickel  
with White Glass  
Height: 16"  
Width: 5.5"  
Extension: 4.25"  
Backplate:  
5.5" x 15" Rectangle

**Finishes:**  
GM, NB, PN  
**Glass Options:** WG

**Socket:** Keyless  
**Wattage:** 40 T

**Designer:**  
Alexa Hampton

AH2023NB-WG



AH2023GM-WG



**TOB2264PN-WG**  
**Eden Short Sconce**  
**in Polished Nickel**  
**with White Glass**

Height: 12.5"  
 Width: 4"  
 Extension: 4.25"  
 Backplate:  
 3.75" x 8.75"  
 Rectangle

**Finishes:** HAB, PN  
**Glass Options:** WG

**Socket:** Keyless  
**Wattage:** 40 T

**Designer:**  
 Thomas O'Brien



**TOB2264HAB-WG**



**TOB2265PN-WG**  
**Eden Long Sconce**  
**in Polished Nickel**  
**with White Glass**

Height: 20.5"  
 Width: 4"  
 Extension: 4.5"  
 Backplate:  
 3.75" x 16.25"  
 Rectangle

**Finishes:** HAB, PN  
**Glass Options:** WG

**Socket:** 2 - Keyless  
**Wattage:** 2 - 40 T

**Designer:**  
 Thomas O'Brien



**TOB2265HAB-WG**





**ARN2013PN-WG**  
**Rosehill Linear Wall**  
**Light in Polished**  
**Nickel with White**  
**Strie Glass**  
Height: 15"  
Width: 6"  
Extension: 4.75"  
Backplate:  
4.5" x 14" Rectangle

**Finishes:** HAB, PN  
**Glass Options:** WG

**Socket:** 2 - Keyless  
**Wattage:** 2 - 60 B

**Designer:**  
AERIN



**TOB2197PN-WG**  
**Milton Road Sconce**  
**in Polished Nickel**  
**with White Glass**

Height: 11"  
Width: 4.5"  
Extension: 5.75"  
Backplate:  
4.5" Round

**Finishes:**  
AN, BZ, HAB, PN  
**Glass Options:** WG

**Socket:** Hi-Lo  
**Wattage:** 60 B

**Designer:**  
Thomas O'Brien

TOB2197HAB-WG

TOB2197BZ-WG



**TOB2198PN-WG**  
**Milton Road Bath Light**  
**in Polished Nickel**  
**with White Glass**

Height: 14.5"  
Width: 3.5"  
Extension: 4"  
Backplate:  
2.5" x 13.5"  
Rectangle

**Finishes:**  
AN, BZ, HAB, PN  
**Glass Options:** WG

**Socket:** 2 - Keyless  
**Wattage:** 2 - 40 B

**Note:** Requires a  
Smaller Outlet Box

**Designer:**  
Thomas O'Brien

TOB2198HAB-WG

TOB2198BZ-WG



**TOB2206PN-WG**  
**Merchant Single Bath**  
**Light in Polished Nickel**  
**with White Glass**  
Height: 12.25"  
Width: 4.5"  
Extension: 5.75"  
Backplate:  
4.5" Round

**Finishes:**  
BZ, CH, HAB, PN  
**Glass Options:** WG

**Socket:** Keyless  
**Wattage:** 40 T

**Designer:**  
Thomas O'Brien

TOB2206HAB-WG



TOB2206BZ-WG



**TOB2207PN-WG**  
**Merchant Double Bath**  
**Light in Polished Nickel**  
**with White Glass**  
Height: 20.75"  
Extension: 5"  
Backplate:  
4.5" Round

**Finishes:**  
BZ, CH, HAB, PN  
**Glass Options:** WG

**Socket:** 2 - Keyless  
**Wattage:** 2 - 40 T

**Designer:**  
Thomas O'Brien

TOB2207HAB-WG



TOB2207BZ-WG



**SS2014PN-FG**  
**Openwork Long Sconce**  
**in Polished Nickel**  
**with Frosted Glass**  
Height: 4.75"  
Width: 24"  
Extension: 5"  
Backplate:  
2 - 4.75" Square

**Finishes:** AN, BZ,  
CH, HAB, PN  
**Glass Options:** FG

**Socket:** 2 - Keyless  
**Wattage:** 2 - 60 T

**Designer:**  
Studio VC



**SS2011PN-FG**  
**Openwork Single**  
**Sconce in Polished**  
**Nickel with**  
**Frosted Glass**  
 Height: 9"  
 Width: 4.75"  
 Extension: 5"  
 Backplate:  
 4.75" Square

**Finishes:**  
 AN, BZ, CH, HAB, PN  
**Glass Options:** FG

**Socket:** Keyless  
**Wattage:** 60 T

**Designer:**  
 Studio VC

SS2011HAB-FG

SS2011BZ-FG



**SS2013PN-FG**  
**Openwork Medium**  
**Sconce in Polished**  
**Nickel with**  
**Frosted Glass**  
 Height: 18"  
 Width: 4.75"  
 Extension: 5"  
 Backplate:  
 (2) 4.75" Square

**Finishes:**  
 AN, BZ, CH, HAB, PN  
**Glass Options:** FG

**Socket:** 2 - Keyless  
**Wattage:** 2 - 60 T

**Designer:**  
 Studio VC

SS2013HAB-FG

SS2013BZ-FG



**TOB2003PN**  
**Mercer Short Box Light**  
 in Polished Nickel  
 with White Glass  
 Height: 9.5"  
 Width: 5.5"  
 Extension: 4"  
 Backplate:  
 5.5" x 9.5" Rectangle

TOB2003HAB

TOB2003BZ

**Finishes:**  
 BZ, CH, HAB, PN  
**Glass Options:** WG

**Socket:** Keyless  
**Wattage:** 60 B

**Designer:**  
 Thomas O'Brien



**TOB2005PN**  
**Mercer Long Box Light**  
 in Polished Nickel  
 with White Glass  
 Height: 24"  
 Width: 5.5"  
 Extension: 4"  
 Backplate:  
 5.5" x 24" Rectangle

TOB2005HAB

TOB2005BZ

**Finishes:**  
 BZ, CH, HAB, PN  
**Glass Options:** WG

**Socket:** 3 - Keyless  
**Wattage:** 3 - 60 B

**Designer:**  
 Thomas O'Brien



**TOB2004BZ**  
**Mercer Square Box**  
**Light in Bronze Box**  
**with White Glass**  
Height: 12"  
Width: 12"  
Extension: 4"  
Backplate: 12" Square

**Finishes:**  
BZ, CH, HAB, PN  
**Glass Options:** WG

**Socket:** 2 - Keyless  
**Wattage:** 2 - 60 B

**Designer:**  
Thomas O'Brien



**TOB2006PN**  
**Ted Sconce in Polished Nickel with White Glass**  
 Height: 14.75"  
 Width: 3.75"  
 Extension: 3.75"  
 Backplate: 3" x 14.75" Rectangle

**Finishes:** BZ, CH, HAB, PN  
**Glass Options:** WG

**Socket:** 2 - Keyless  
**Wattage:** 2 - 40 B

**Note:** Requires a Smaller Outlet Box

**Designer:** Thomas O'Brien

TOB2006HAB

TOB2006BZ



**ARN2010PN-CG**  
**Deauville Single Sconce in Polished Nickel with Clear Glass**  
 Height: 14.5"  
 Width: 5.25"  
 Extension: 7"  
 Backplate: 4.25" x 14.5" Rectangle

**Finishes:** BZ, HAB, PN  
**Glass Options:** CG

**Socket:** Candelabra  
**Wattage:** 60 C

**Designer:** AERIN

ARN2010HAB-CG

ARN2010BZ-CG





**CHD2055PN-WG**  
**Easterly Sconce in Polished Nickel with White Glass**  
Height: 9.25"  
Width: 5"  
Extension: 6.5"  
Backplate: 2.5" x 4.5"

**Finishes:**  
AB, AN, BZ, PN  
**Glass Options:** WG

**Socket:** Keyless  
**Wattage:** 60 B

**Note:** Requires a Smaller Outlet Box

**Designer:**  
E. F. Chapman

©EFC DESIGNS

CHD2055AB-WG



CHD2055BZ-WG



**CHD2050AB-WG**  
**Stanway Sconce in Antique-Burnished Brass with White Glass**  
Height: 10.75"  
Width: 4"  
Extension: 5"  
Backplate: 3.25" x 4.5"

**Finishes:**  
AB, AN, BZ, PN  
**Glass Options:** CG, WG

**Socket:** Keyless  
**Wattage:** 60 B

**Note:** Requires a Smaller Outlet Box

**Designer:**  
E. F. Chapman

©EFC DESIGNS

CHD2050BZ-WG



CHD2050AB-CG



**SL2000PN-WG**  
**Marine Wall Light**  
**in Polished Nickel**  
**with White Glass**  
Height: 10.5"  
Width: 4.5"  
Extension: 7.75"  
Backplate:  
4.5" x 6.5" Rectangle

SL2000HAB-WG

SL2000BZ-WG

**Finishes:**  
AN, BZ, CH, HAB, PN  
**Glass Options:** WG

**Socket:** Keyless  
**Wattage:** 60 A

**Designer:**  
E. F. Chapman

©EFC DESIGNS



**TOB2210PN-WG**  
**Milton Small Sconce**  
**in Polished Nickel**  
**with White Glass**  
Height: 11"  
Width: 6"  
Extension: 7.25"  
Backplate: 5.5" Round

TOB2210HAB-WG

TOB2210BZ-WG

**Finishes:**  
BZ, HAB, PN  
**Glass Options:** WG

**Socket:** Keyless  
**Wattage:** 60 A

**Designer:**  
Thomas O'Brien



**TOB2212PN-WG**  
**Milton Short Sconce**  
**in Polished Nickel**  
**with White Glass**  
Height: 11.5"  
Width: 7.25"  
Extension: 4.25"  
Backplate:  
7.25" x 11.25" Rectangle

**Finishes:** BZ, HAB, PN  
**Glass Options:** WG

**Socket:** Keyless  
**Wattage:** 60 B

**Designer:**  
Thomas O'Brien

TOB2212HAB-WG

TOB2212BZ-WG



**TOB2213PN-WG**  
**Milton Long Sconce**  
**in Polished Nickel**  
**with White Glass**  
Height: 20.25"  
Width: 7.25"  
Extension: 4.75"  
Backplate:  
7.25" x 20.25" Rectangle

**Finishes:** BZ, HAB, PN  
**Glass Options:** WG

**Socket:** 2 - Keyless  
**Wattage:** 2 - 60 B

**Designer:**  
Thomas O'Brien

TOB2213HAB-WG

TOB2213BZ-WG



**TOB2209PN-WG**  
**Pelham Oval Light**  
**in Polished Nickel**  
**with White Glass**  
 Height: 11.5"  
 Width: 6.25"  
 Extension: 3.75"  
 Backplate:  
 6.25" x 11.5" Oval

TOB2209HAB-WG

TOB2209BZ-WG

**Finishes:**  
 BZ, CH, HAB, PN  
**Glass Options:** WG

**Socket:** Keyless  
**Wattage:** 60 B

**Designer:**  
 Thomas O'Brien



**TOB2208PN-WG**  
**Pelham Moon Light**  
**in Polished Nickel**  
**with White Glass**  
 Height: 10"  
 Width: 10"  
 Extension: 5.25"  
 Backplate: 10" Round

TOB2208HAB-WG

TOB2208BZ-WG

**Finishes:**  
 BZ, CH, HAB, PN  
**Glass Options:** WG

**Socket:** Keyless  
**Wattage:** 60 B

**Designer:**  
 Thomas O'Brien







**BBL2105PN-WG**  
**Tapered Sconce**  
**in Polished Nickel**  
**with White Glass**  
 Height: 8.5"  
 Width: 4"  
 Extension: 4.5"  
 Backplate: 4" Square

**Finishes:** BZ, CW,  
 GY, PN, SB, SS  
**Glass Options:** WG

**Socket:** Candelabra  
**Wattage:** 60 B

**Designer:**  
 Barbara Barry



**BBL2105SB-WG**



**BBL2105BZ-WG**



**BBL2090PN-FG**  
**Cylinder Sconce**  
**in Polished Nickel**  
**with Frosted Glass**  
 Height: 9"  
 Width: 4"  
 Extension: 5"  
 Backplate: 4" Square

**Finishes:**  
 BZ, PN, SB, SS  
**Glass Options:** FG

**Socket:** Keyless  
**Wattage:** 60 B

**Designer:**  
 Barbara Barry



**BBL2090SB-FG**



**BBL2090BZ-FG**



**BBL2094PN-WG**  
**Glass Sconce**  
**in Polished Nickel**  
**with White Glass**  
 Height: 9"  
 Width: 6.25"  
 Extension: 7"  
 Backplate: 4" Square

**Finishes:**  
 BZ, PN, SB, SS  
**Glass Options:** WG

**Socket:** Keyless  
**Wattage:** 60 B

**Designer:**  
 Barbara Barry



**BBL2094SB-WG**



**BBL2094BZ-WG**



**KW2043PN-WG**  
**Utopia Small Single**  
**Bath Sconce in**  
**Polished Nickel**  
**with White Glass**  
Height: 14"  
Width: 4.75"  
Extension: 5"  
Backplate: 4.75" x 7"

**KW2043G-WG**

**KW2043AI-WG**

**Finishes:** AB, AI, PN

**Socket:** Keyless  
**Wattage:** 60 B

**Designer:**  
Kelly Wearstler



**KW2044PN-WG**  
**Utopia Large Single**  
**Bath Sconce in**  
**Polished Nickel**  
**with White Glass**  
Height: 18"  
Width: 7.5"  
Extension: 6.25"  
Backplate: 7.5" x 18"

**KW2044G-WG**

**KW2044AI-WG**

**Finishes:** AB, AI, PN  
**Socket:** Keyless

**Wattage:** 60 T

**Designer:**  
Kelly Wearstler





**KW2047PN-WG**  
**Utopia Small Double**  
**Bath Sconce in**  
**Polished Nickel**  
**with White Glass**  
 Height: 18"  
 Width: 4.5"  
 Extension: 5"  
 Backplate: 4.5" x 7.5"

**Finishes:** AB, AI, PN

**Socket:** 2 - Keyless  
**Wattage:** 2 - 60 B

**Designer:**  
 Kelly Wearstler

**KW2047G-WG**

**KW2047AI-WG**



**KW2048PN-WG**  
**Utopia Large Double**  
**Bath Sconce in**  
**Polished Nickel**  
**with White Glass**  
 Height: 4.75"  
 Width: 23"  
 Extension: 5"  
 Backplate: 4.75" x 9.25"

**Finishes:** AB, AI, PN

**Socket:** 2 - Keyless  
**Wattage:** 2 - 60 T

**Designer:**  
 Kelly Wearstler

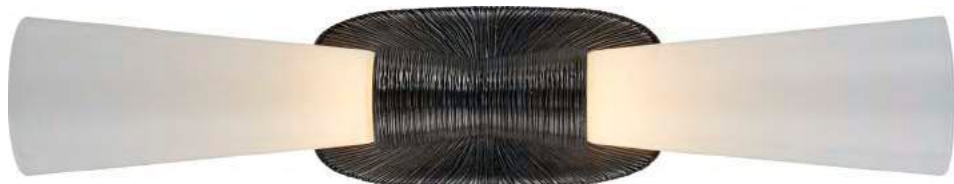

**KW2048G-WG**

**KW2048AI-WG**



**KW2050G-FR**  
**Utopia Asymmetric**  
**Sconce in Gild**  
**with Fractured Glass**  
Height: 8"  
Width: 5.75"  
Extension: 3.5"  
Backplate:  
3.5" x 5" Rectangle

**Finishes:** AI, G  
**Glass Options:** FR

**Socket:** Candelabra  
**Wattage:** 60 B

**Note:** Requires a  
Smaller Outlet Box

**Designer:**  
Kelly Wearstler

**KW2050AI-FR**



**KW2057G-FR**  
**Utopia Large**  
**Sconce in Gild**  
**with Fractured Glass**  
Height: 16"  
Width: 5.25"  
Extension: 4"  
Backplate:  
3.75" x 14.5" Rectangle

**Finishes:** AI, G  
**Glass Options:** FR

**Socket:**  
2 - Candelabra  
**Wattage:** 2 - 40 B

**Note:** Requires a  
Smaller Outlet Box

**Designer:**  
Kelly Wearstler

**KW2057AI-FR**



**BBL2020PN-WG**  
**Bowmont Single Sconce**  
**in Polished Nickel**  
**with White Glass**

Height: 13"  
 Width: 4"  
 Extension: 5.5"  
 Backplate: 4" x 7.5" Oval

**Finishes:** BZ, PN, SB  
**Glass Options:** WG

**Socket:** Candelabra  
**Wattage:** 60 C

**Designer:**  
 Barbara Barry



**BBL2020SB-WG**



**BBL2020BZ-WG**



**ARN2018PN/CG-WG**  
**Drunmore Single Sconce**  
**in Polished Nickel**  
**and Crystal with**  
**White Glass Shade**

Height: 14.25"  
 Width: 4.5"  
 Extension: 6.75"  
 Backplate: 4.5" Round

**Finishes:** BZ, BZ/CG,  
 HAB, HAB/CG,  
 PN, PN/CG

**Shade Treatments:**  
 L, WG

**Shade Details:**  
 4.5" x 4.5" x 8.5"

**Socket:** Candelabra  
**Wattage:** 40 B

**Designer:**  
 AERIN



**ARN2018HAB/CG-WG**



**ARN2018BZ/CG-WG**



**TOB2015PN-WG**  
**Bryant Bath Sconce**  
**in Polished Nickel**  
**with White Glass**

Height: 14"  
Width: 4"  
Extension: 8.25"  
Backplate: 4" Round

**Finishes:**  
AN, BZ, HAB, PN  
**Glass Options:** WG

**Socket:** Keyless  
**Wattage:** 40 T

**Note:** Requires a  
Smaller Outlet Box

**Designer:**  
Thomas O'Brien

TOB2015HAB-WG



TOB2015BZ-WG



**TOB2022PN-WG**  
**Bryant Sconce in**  
**Polished Nickel**  
**with White Glass**

Height: 14.5"  
Width: 5.5"  
Extension: 8.75"  
Backplate: 4.25" Round

**Finishes:**  
AN, BZ, HAB, PN  
**Glass Options:** WG  
**Shade Details:**  
4" x 5.5" x 6"

**Socket:** Keyless  
**Wattage:** 40 B

**Note:** Requires a  
Smaller Outlet Box

**Designer:**  
Thomas O'Brien

TOB2022HAB-WG



TOB2022BZ-WG



**TOB2152PN-WG**  
**Bryant Single Bath Sconce in Polished Nickel with White Glass**

Height: 8"  
 Width: 4"  
 Extension: 5.5"  
 Backplate:  
 4" x 5" Rectangle

**Finishes:**  
 AN, BZ, HAB, PN  
**Glass Options:** WG

**Socket:**  
 Candelabra  
**Wattage:** 60 B

**Designer:**  
 Thomas O'Brien

TOB2152AN-WG



TOB2152BZ-WG



TOB2152HAB-WG



**TOB2153PN-WG**  
**Bryant Four-Light Bath Sconce in Polished Nickel with White Glass**

Height: 8"  
 Width: 19.5"  
 Extension: 5.5"  
 Backplate:  
 4" x 5" Rectangle

**Finishes:**  
 AN, BZ, HAB, PN  
**Glass Options:** WG

**Socket:**  
 4 - Candelabra  
**Wattage:** 4 - 60 B

**Designer:**  
 Thomas O'Brien



**TOB2153HAB-WG**



**TOB2154PN-WG**  
**Bryant Six-Light Linear**  
**Bath Sconce in Polished**  
**Nickel with White Glass**

Height: 8"  
Width: 29"  
Extension: 5.5"  
Backplate:  
4" x 5" Rectangle

**Finishes:**  
AN, BZ, HAB, PN  
**Glass Options:** WG

**Socket:**  
6 - Candelabra  
**Wattage:** 6 - 60 B

**Designer:**  
Thomas O'Brien



**TOB2154AN-WG**



**TOB2154HAB-WG**



**TOB2154BZ-WG**



**S2150PN-CG**  
**Kendal Single Sconce**  
**in Polished Nickel**  
**with Clear Glass**

Height: 9"  
Width: 4.5"  
Extension: 3.5"  
Backplate:  
4.5" Square

**Finishes:**  
AN, BZ, HAB, PN  
**Glass Options:** CG

**Socket:** GU10  
**Wattage:** 35 J

**Designer:**  
Ian Fowler

S2150BZ-CG



**S2155PN-CG**  
**Kendal Double Sconce**  
**in Polished Nickel**  
**with Clear Glass**

Height: 10"  
Width: 8.5"  
Extension: 3"  
Backplate: 4.5" Square

**Finishes:**  
AN, BZ, HAB, PN  
**Glass Options:** CG

**Socket:** 2 - GU10  
**Wattage:** 2 - 35 J

**Designer:**  
Ian Fowler

S2155BZ-CG





**CHD2051BZ-FG  
Lund 12" Single  
Sconce in Bronze  
with Mirror  
and Frosted Glass**

Height: 12"  
Width: 6"

Extension: 3"

Backplate:

4.25" x 11.25" Rectangle

**Finishes:** AB, BZ, PN

**Glass Options:** FG

**Socket:** Candelabra

**Wattage:** 60 C

**Designer:**

E. F. Chapman

©EFC DESIGNS



**SL2841PN-WG**  
**Wilton Single**  
**Bath Light in**  
**Polished Nickel**  
**with White Glass**  
 Height: 10"  
 Width: 5"  
 Extension: 8.5"  
 Backplate: 5" Round

**Finishes:** AN, BZ,  
 CH, HAB, PN  
**Glass Options:** WG

**Socket:** Keyless  
**Wattage:** 60 B

**Designer:**  
 E. F. Chapman

©EFC DESIGNS

SL2841AN-WG



SL2841HAB-WG



**SL2842PN-WG**  
**Wilton Double**  
**Bath Light in**  
**Polished Nickel**  
**with White Glass**  
 Height: 10"  
 Width: 13"  
 Extension: 8.5"  
 Backplate: 5" Round

**Finishes:** AN, BZ,  
 CH, HAB, PN  
**Glass Options:** WG

**Socket:** 2 - Keyless  
**Wattage:** 2 - 60 B

**Designer:**  
 E. F. Chapman

©EFC DESIGNS

SL2842HAB-WG



**SL2843PN-WG**  
**Wilton Triple**  
**Bath Light in**  
**Polished Nickel**  
**with White Glass**  
 Height: 10"  
 Width: 21"  
 Extension: 8.5"  
 Backplate: 5" Round

**Finishes:** AN, BZ,  
 CH, HAB, PN  
**Glass Options:** WG

**Socket:** 3 - Keyless  
**Wattage:** 3 - 60 B

**Designer:**  
 E. F. Chapman

©EFC DESIGNS



**SL2151CH-WG**  
**New York Subway**  
**Single Light**  
**in Chrome with**  
**White Glass**  
 Height: 9.75"  
 Width: 5"  
 Extension: 8"  
 Backplate: 4.5" Square

**Finishes:** AN, BZ,  
 CH, HAB, PN  
**Glass Options:** WG

**Socket:** Keyless  
**Wattage:** 60 B

**Designer:**  
 E. F. Chapman

©EFC DESIGNS



SL2151AN-WG



SL2151BZ-WG



**SL2152PN-WG**  
**New York Subway**  
**Double Light**  
**in Polished Nickel**  
**with White Glass**  
 Height: 9.75"  
 Width: 14"  
 Extension: 8"  
 Backplate: 4.5" Square

**Finishes:** AN, BZ,  
 CH, HAB, PN  
**Glass Options:** WG

**Socket:** 2 - Keyless  
**Wattage:** 2 - 60 B

**Designer:**  
 E. F. Chapman

©EFC DESIGNS



SL2152HAB-WG



**SL2153BZ-WG**  
**New York Subway**  
**Triple Light**  
**in Bronze**  
**with White Glass**  
 Height: 9.75"  
 Width: 22.75"  
 Extension: 8"  
 Backplate: 4.5" Square

**Finishes:** AN, BZ,  
 CH, HAB, PN  
**Glass Options:** WG

**Socket:** 3 - Keyless  
**Wattage:** 3 - 60 B

**Designer:**  
 E. F. Chapman

©EFC DESIGNS



**TOB2261PN-FG**  
**Patrick Sconce**  
 in Polished Nickel  
 with Frosted Glass  
 Height: 10.25"  
 Width: 7.5"  
 Extension: 5.75"  
 Canopy: 4.5" Round  
 Backplate:  
 4" x 6.5" Oval

**Finishes:**  
 BZ, HAB, PN  
**Glass Options:** FG

**Socket:** Keyless  
**Wattage:** 60 A

**Designer:**  
 Thomas O'Brien

TOB2261HAB-FG

TOB2261BZ-FG



**TOB2011PN-WG**  
**Metropolitan Sconce**  
 in Polished Nickel  
 with White Glass  
 Height: 11"  
 Width: 5"  
 Extension: 6.25"  
 Backplate: 4.5" Round

**Finishes:**  
 BZ, CH, HAB, PN  
**Shade Treatments:**  
 NP, NP/BT, WG  
**Shade Details:**  
 2.5" x 6"

**Socket:** Keyless  
**Wattage:** 60 B

**Designer:**  
 Thomas O'Brien

TOB2011HAB-WG

TOB2011BZ-WG



**S2003PN-WG**  
**Shield Round**  
**Sconce in Polished**  
**Nickel with White**  
**Flat Panel Glass**  
Height: 13"  
Width: 7"  
Extension: 4.25"  
Backplate:  
5.5" Round

**Finishes:**  
BZ, HAB, PN  
**Glass Options:** WG

**Socket:** Candelabra  
**Wattage:** 60 C

**Designer:**  
Studio VC

S2003HAB-WG



S2003BZ-WG



**S2006PN-WG**  
**Cylinder Sconce**  
**in Polished Nickel**  
**with White Glass**  
Height: 13"  
Width: 5.5"  
Extension: 5.5"  
Backplate: 5.5" Round

**Finishes:**  
BZ, HAB, PN  
**Glass Options:** WG  
**Shade Details:**  
4.25" x 8" Cylinder

**Socket:** Keyless  
**Wattage:** 60 B

**Designer:**  
Studio VC

S2006HAB-WG



S2006BZ-WG



**TOB2187PN-WG**  
**Graydon Single**  
**Bath Light in**  
**Polished Nickel**  
**with White Glass**  
Height: 11.5"  
Width: 4.25"  
Extension: 7"  
Backplate: 4.5" Round

**Finishes:**  
BZ, HAB, PN  
**Glass Options:** WG

**Socket:** Keyless  
**Wattage:** 60 T

**Designer:**  
Thomas O'Brien

TOB2187HAB-WG

TOB2187BZ-WG



**TOB2186PN-WG**  
**Graydon Double**  
**Bath Light in**  
**Polished Nickel with**  
**White Glass**  
Height: 18"  
Extension: 6.5"  
Backplate: 4.25"

**Finishes:**  
BZ, HAB, PN  
**Glass Options:** WG  
**Shade Details:**  
2.5" x 6.5"

**Socket:** 2 - Keyless  
**Wattage:** 2 - 40 T

**Designer:**  
Thomas O'Brien

TOB2186HAB-WG



TOB2186BZ-WG

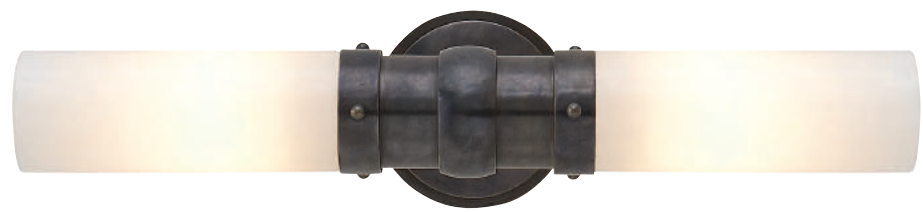

**TOB2050PN-WG**  
**Dara Single Sconce**  
 in Polished Nickel  
 with White Glass  
 Height: 10"  
 Width: 3.5"  
 Extension: 5.5"  
 Backplate:  
 3" x 5" Rectangle

**Finishes:**  
 BZ, HAB, PN  
**Glass Options:** WG

**Socket:** Keyless  
**Wattage:** 60 A

**Note:** Requires a  
 Smaller Outlet Box

**Designer:**  
 Thomas O'Brien

TOB2050HAB-WG

TOB2050BZ-WG



**TOB2051PN-WG**  
**Dara Double Sconce**  
 in Polished Nickel  
 with White Glass  
 Height: 15"  
 Width: 5"  
 Extension: 5.5"  
 Backplate:  
 3" x 5" Rectangle

**Finishes:**  
 BZ, HAB, PN  
**Glass Options:** WG

**Socket:** 2 - Keyless  
**Wattage:** 2 - 40 A

**Note:** Requires a  
 Smaller Outlet Box

**Designer:**  
 Thomas O'Brien

TOB2051HAB-WG

TOB2051BZ-WG







**SL2975PN-WG**  
**Yoke Suspended Sconce**  
**in Polished Nickel**  
**with White Glass**

Height: 10.25"  
Width: 5"  
Extension: 9.5"  
Backplate:  
4.5" Round

**Finishes:**  
AN, BZ, HAB, PN  
**Shade Treatments:**  
AN, BZ, HAB, PN, WG

**Socket:** Keyless  
**Wattage:** 60 B

**Note:** Shade is  
White Inside

**Designer:**  
E. F. Chapman

©EFC DESIGNS

SL2975AN-WG

SL2975HAB-WG



**CHD2153PN-WG**  
**Pimlico Single Light**  
**in Polished Nickel**  
**with White Glass**

Height: 11"  
Width: 6"  
Extension: 12"  
Backplate:  
3" x 6.5" Rectangle

**Finishes:**  
AB, AN, PN  
**Glass Options:** WG

**Socket:** On-Off  
**Wattage:** 60 B

**Note:** Requires a  
Smaller Outlet Box

**Designer:**  
E. F. Chapman

©EFC DESIGNS

CHD2153AN-WG

CHD2153AB-WG



**ARN2004PN-WG**  
**Union Single**  
**Arm Sconce in**  
**Polished Nickel**  
**with White Glass**  
 Height: 12"  
 Width: 7"  
 Extension: 10.5"  
 Backplate:  
 5.25" Square

ARN2004HAB-WG

ARN2004BZ-WG

**Finishes:**  
 BZ, HAB, PN  
**Shade Treatments:**  
 L, WG

**Socket:** Candelabra  
**Wattage:** 60 B

**Designer:**  
 AERIN



**ARN2005PN-WG**  
**Union Double**  
**Arm Sconce in**  
**Polished Nickel**  
**with White Glass**  
 Height: 12"  
 Width: 17.5"  
 Extension: 10.5"  
 Backplate: 5.25" Square

ARN2005BZ-WG

**Finishes:** BZ, HAB, PN  
**Shade Treatments:**  
 L, WG

**Socket:**  
 2 - Candelabra  
**Wattage:**  
 2 - 60 B

**Designer:**  
 AERIN



**CHD1531PN-FG**  
**Essex Single Formal**  
**in Polished Nickel**  
**with Frosted Glass**  
Height: 10"  
Width: 6"  
Extension: 9.5"  
Backplate: 4.5" Square

**Finishes:**  
AB, AN, BZ, PN  
**Glass Options:** FG

**Socket:** Keyless  
**Wattage:** 60 B

**Designer:**  
E. F. Chapman

©EFC DESIGNS

CHD1531AB-FG

CHD1531BZ-FG



**CHD1532PN-FG**  
**Essex Double Formal**  
**in Polished Nickel**  
**with Frosted Glass**  
Height: 10"  
Width: 15"  
Extension: 9.5"  
Backplate: 4.5" Square

**Finishes:**  
AB, AN, BZ, PN  
**Glass Options:** FG

**Socket:** 2 - Keyless  
**Wattage:** 2 - 60 B

**Designer:**  
E. F. Chapman

©EFC DESIGNS

CHD1532BZ-FG



**SL2941CH-FG**  
**Boston Square Single**  
**Light in Chrome**  
**with Frosted Glass**  
 Height: 11"  
 Width: 5"  
 Extension: 8.5"  
 Backplate:  
 4.5" x 5" Rectangle

**Finishes:**  
 AN, BZ, CH, HAB, PN  
**Glass Options:** FG

**Socket:** On-Off  
**Wattage:** 60 B

**Designer:**  
 E. F. Chapman

©EFC DESIGNS

SL2941AN-FG



SL2941HAB-FG



**SL2942HAB-FG**  
**Boston Square Double**  
**Light in Hand-Rubbed**  
**Antique Brass with**  
**Frosted Glass**  
 Height: 11"  
 Width: 14"  
 Extension: 8.5"  
 Backplate:  
 4.5" x 5" Rectangle

**Finishes:**  
 AN, BZ, CH, HAB, PN  
**Glass Options:** FG

**Socket:** 2 - On-Off  
**Wattage:** 2 - 60 B

**Designer:**  
 E. F. Chapman

©EFC DESIGNS

SL2942BZ-FG

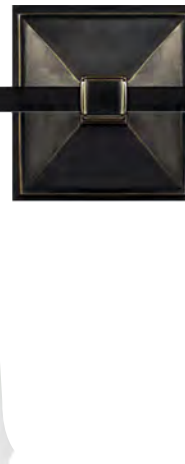

**SL2943PN-FG**  
**Boston Square Triple**  
**Light Sconce in**  
**Polished Nickel with**  
**Frosted Glass**  
 Height: 11"  
 Width: 22"  
 Extension: 8.5"  
 Backplate:  
 4.5" x 5" Rectangle

**Finishes:**  
 AN, BZ, CH, HAB, PN  
**Glass Options:** FG

**Socket:** 3 - On-Off  
**Wattage:** 3 - 60 B

**Designer:**  
 E. F. Chapman

©EFC DESIGNS



**CHD1515PN-WG**  
**Chinoiserie Single Light**  
**in Polished Nickel**  
**with White Glass**

Height: 11"  
Width: 5.25"  
Extension: 7.5"  
Backplate:  
4.75" Square

**Finishes:**  
AB, AN, BZ, PN  
**Glass Options:** WG

**Socket:** Keyless  
**Wattage:** 60 B

**Designer:**  
E. F. Chapman

©EFC DESIGNS



CHD1515AB-WG



CHD1515BZ-WG



**CHD1516PN-WG**  
**Chinoiserie Double Light**  
**in Polished Nickel**  
**with White Glass**

Height: 11"  
Width: 13"  
Extension: 7.5"  
Backplate: 4.75" Square

**Finishes:**  
AB, AN, BZ, PN  
**Glass Options:** WG

**Socket:**  
2 - Keyless  
**Wattage:** 2 - 60 B

**Designer:**  
E. F. Chapman

©EFC DESIGNS



CHD1516AB-WG



**CHD1517PN-WG**  
**Chinoiserie Triple Light**  
**in Polished Nickel**  
**with White Glass**

Height: 11"  
Width: 21"  
Extension: 7.5"  
Backplate:  
4.75" Square

**Finishes:**  
AB, AN, BZ, PN  
**Glass Options:** WG

**Socket:** 3 - Keyless  
**Wattage:** 3 - 60 B

**Designer:**  
E. F. Chapman

©EFC DESIGNS



**SS2001PN-WG**  
**Siena Single Sconce**  
**in Polished Nickel**  
**with White Glass**  
 Height: 8.25"  
 Width: 4.75"  
 Extension: 6.5"  
 Backplate:  
 4.75" Square

**Finishes:**  
 BZ, HAB, PN  
**Glass Options:** WG

**Socket:** Keyless  
**Wattage:** 40 A

**Designer:**  
 Studio VC

SS2001HAB-WG



SS2001BZ-WG



**SS2002HAB-WG**  
**Siena Double Sconce**  
**in Hand-Rubbed**  
**Antique Brass with**  
**White Glass**  
 Height: 8.25"  
 Width: 15"  
 Extension: 6"  
 Backplate:  
 4.75" Square

**Finishes:**  
 BZ, HAB, PN  
**Glass Options:** WG

**Socket:** 2 - Keyless  
**Wattage:** 2 - 60 A

**Designer:**  
 Studio VC

SS2002BZ-WG

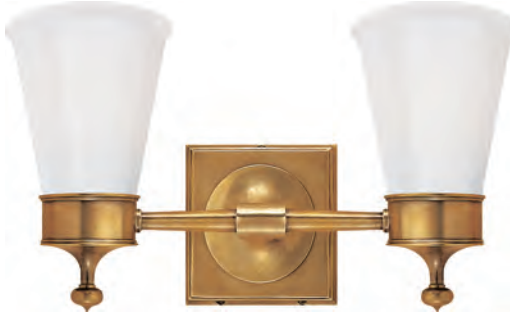

**SS2003PN-WG**  
**Siena Triple Sconce**  
**in Polished Nickel**  
**with White Glass**  
 Height: 8.25"  
 Width: 23"  
 Extension: 10.75"  
 Backplate:  
 4.75" Square

**Finishes:**  
 BZ, HAB, PN  
**Glass Options:** WG

**Socket:** 3 - Keyless  
**Wattage:** 3 - 60 A

**Designer:**  
 Studio VC



**CHD2462PN-WG**  
**Ruhlmann Single Bath Sconce in Polished Nickel with White Glass**  
Height: 10.5"  
Width: 5.5"  
Extension: 7"  
Backplate: 4.25" Round

**Finishes:**  
AB, AN, BZ, PN  
**Glass Options:** WG

**Socket:** Keyless  
**Wattage:** 60 B

**Designer:**  
E. F. Chapman

©EFC DESIGNS



CHD2462AB-WG



CHD2462BZ-WG



**CHD2463PN-WG**  
**Ruhlmann Double Bath Sconce in Polished Nickel with White Glass**  
Height: 10.5"  
Width: 14.5"  
Extension: 7"  
Backplate: 4.25" Round

**Finishes:**  
AB, AN, BZ, PN  
**Glass Options:** WG

**Socket:** 2 - Keyless  
**Wattage:** 2 - 60 B

**Designer:**  
E. F. Chapman

©EFC DESIGNS



CHD2463BZ-WG



**CHD2464PN-WG**  
**Ruhlmann Triple Bath Sconce in Polished Nickel with White Glass**  
Height: 10.5"  
Width: 23.5"  
Extension: 7"  
Backplate: 4.25" Round

**Finishes:**  
AB, AN, BZ, PN  
**Glass Options:** WG

**Socket:** 3 - Keyless  
**Wattage:** 3 - 60 B

**Designer:**  
E. F. Chapman

©EFC DESIGNS



**AH2201PN-CG**  
**Lita Single Sconce**  
**in Polished Nickel**  
**with Crystal**  
Height: 9.5"  
Width: 4.5"  
Extension: 6.25"  
Backplate: 4.5" Round

AH2201HAB-CG

AH2201BZ-CG

**Finishes:**  
AN, BZ, HAB, PN  
**Glass Options:** CG

**Socket:** Keyless  
**Wattage:** 60 A

**Designer:**  
Alexa Hampton



**AH2203PN-CG**  
**Lita Triple Sconce**  
**in Polished Nickel**  
**with Crystal**  
Height: 9.5"  
Width: 20"  
Extension: 6.25"  
Backplate: 4.5" Round

**Finishes:**  
AN, BZ, HAB, PN  
**Glass Options:** CG

**Socket:** 3 - Keyless  
**Wattage:** 3 - 60 A

**Designer:**  
Alexa Hampton









**AH2200PN-CG**  
**Ava Single Sconce**  
**in Polished Nickel**  
**with Crystal**  
Height: 9.25"  
Width: 4.5"  
Extension: 6"  
Backplate: 4.5" Round

**Finishes:**  
AN, BZ, HAB, PN  
**Glass Options:** CG

**Socket:** Keyless  
**Wattage:** 60 A

**Designer:**  
Alexa Hampton

AH2200HAB-CG

AH2200BZ-CG



**AH2202PN-CG**  
**Ava Triple Sconce**  
**in Polished Nickel**  
**with Crystal**  
Height: 9.25"  
Width: 20"  
Extension: 6"  
Backplate: 4.5" Round

**Finishes:**  
AN, BZ, HAB, PN  
**Glass Options:** CG

**Socket:**  
3 - Keyless  
**Wattage:** 3 - 60 A

**Designer:**  
Alexa Hampton



**SL2934PN-WG**  
**Boston Loop**  
**Arm Sconce in**  
**Polished Nickel**  
**with White Glass**  
 Height: 12.5"  
 Width: 4.75"  
 Extension: 7.5"  
 Backplate:  
 4.75" Round

**Finishes:**  
 AN, BZ, CH,  
 HAB, PN  
**Glass Options:**  
 CG, WG

**Socket:** On-Off  
**Wattage:** 60 B

**Designer:**  
 E. F. Chapman

©EFC DESIGNS

SL2934HAB-WG

SL2934BZ-WG



**SL2935PN-WG**  
**Boston Head Light**  
**Sconce in Antique**  
**Nickel with**  
**White Glass**  
 Height: 11.5"  
 Width: 6"  
 Extension: 6.25"  
 Backplate:  
 4.75" Round

**Finishes:**  
 AN, BZ, CH, HAB, PN  
**Glass Options:** WG

**Socket:** On-Off  
**Wattage:** 60 B

**Designer:**  
 E. F. Chapman

©EFC DESIGNS

SL2935HAB-WG

SL2935BZ-WG





**SL2931PN/SLEG-WG**

**Boston Functional  
Single Light in  
Polished Nickel  
with White Glass**  
Height: 9"  
Width: 5.75"  
Extension: 9.5"  
Backplate: 4.5" Round

**Finishes:**  
AN, BZ, CH, HAB, PN  
**Glass Options:** WG  
**Shade Details:**  
2.25" x 5.75" x 4.5"

**Socket:** On-Off  
**Wattage:** 60 B

**Designer:**  
E. F. Chapman

©EFC DESIGNS



**SL2931HAB/SLEG-WG**



**SL2931BZ/SLEG-WG**



**SL2932PN/SLEG-WG**

**Boston Functional  
Double Light in  
Polished Nickel  
with White Glass**  
Height: 9"  
Width: 14.5"  
Extension: 9.5"  
Backplate: 4.5" Round

**Finishes:**  
AN, BZ, CH, HAB, PN  
**Glass Options:** WG  
**Shade Details:**  
2.25" x 5.75" x 4.5"

**Socket:** 2 - On-Off  
**Wattage:** 2 - 60 B

**Designer:**  
E. F. Chapman

©EFC DESIGNS



**SL2932AN/SLEG-WG**



**SL2933HAB/SLEG-WG**

**Boston Functional  
Triple Light in  
Hand-Rubbed  
Antique Brass  
with White Glass**  
Height: 9"  
Width: 23"  
Extension: 9.5"  
Backplate:  
4.5" Round

**Finishes:**  
AN, BZ, CH, HAB, PN  
**Glass Options:** WG  
**Shade Details:**  
2.25" x 5.75" x 4.5"

**Socket:** 3 - On-Off  
**Wattage:** 3 - 60 B

**Designer:**  
E. F. Chapman

©EFC DESIGNS



**SL2931PN**  
**Boston Functional**  
**Single Light in**  
**Polished Nickel**  
Height: 9"  
Width: 4.5"  
Extension: 9.5"  
Backplate: 4.5" Round

**Finishes:**  
AN, BZ, CH, HAB, PN  
**Glass Options:** WG

**Socket:** On-Off  
**Wattage:** 60 B

**Note:** Bulb Sold  
Separately (B-30M)

**Designer:**  
E. F. Chapman

©EFC DESIGNS

SL2931AN



SL2931BZ



**SL2932PN**  
**Boston Functional**  
**Double Light in**  
**Polished Nickel**  
Height: 9"  
Width: 12"  
Extension: 9.5"  
Backplate: 4.5" Round

**Finishes:**  
AN, BZ, CH, HAB, PN  
**Glass Options:** WG

**Socket:** 2 - On-Off  
**Wattage:** 2 - 60 B

**Note:** Bulb Sold  
Separately (B-30M)

**Designer:**  
E. F. Chapman

©EFC DESIGNS

SL2932AN



**SL2933HAB**  
**Boston Functional**  
**Triple Light in Hand-**  
**Rubbed Antique Brass**  
Height: 9"  
Width: 20.5"  
Extension: 9.5"  
Backplate: 4.5" Round

**Finishes:**  
AN, BZ, CH, HAB, PN  
**Glass Options:** WG

**Socket:** 3 - On-Off  
**Wattage:** 3 - 60 B

**Note:** Bulb Sold  
Separately (B-30M)

**Designer:**  
E. F. Chapman

©EFC DESIGNS



**CHD2473PN-CG**  
**Covington Shield**  
**Sconce in**  
**Polished Nickel**  
**with Clear Glass**  
Height: 12.75"  
Width: 7.75"  
Extension: 8.5"  
Backplate:  
4.5" x 5" Rectangle

**Finishes:**  
AB, AN, BZ, PN

**Socket:** Keyless  
**Wattage:** 100 A

**Note:**  
Bulb Sold  
Separately (B-30M)

**Designer:**  
E. F. Chapman

©EFC DESIGNS

CHD2473AN-CG



CHD2473AB-CG



CHD2473BZ-CG





**CHD2472PN-CG**  
**Covington Sconce**  
**in Polished Nickel**  
**with Clear Ribbed**  
**Wide Glass**  
Height: 12.75"  
Width: 6.5"  
Extension: 8"  
Backplate:  
4.5" x 5" Rectangle

**Finishes:**  
AB, AN, BZ, PN

**Socket:** Keyless  
**Wattage:** 100 A

**Designer:**  
E. F. Chapman

©EFC DESIGNS



CHD2472AN-CG



**CHD2474AB-CG**  
**Covington Sconce**  
**in Antique-Burnished**  
**Brass with Clear**  
**Ribbed Narrow Glass**  
Height: 10.5"  
Width: 4.5"  
Extension: 6"  
Backplate:  
4.5" x 5" Rectangle

**Finishes:**  
AB, AN, BZ, PN

**Socket:** Keyless  
**Wattage:** 100 A

**Designer:**  
E. F. Chapman

©EFC DESIGNS



CHD2474BZ-CG





**TOB2225PN/G1-CG**  
**Katie Small Bell**  
**Jar Sconce in**  
**Polished Nickel with**  
**Clear Glass**  
Height: 18"  
Width: 8.2"  
Extension: 9"  
Backplate:  
5.25" Round

**Finishes:** BZ, HAB, PN  
**Glass Options:**  
CG, SG, WG

**Socket:** Candelabra  
**Wattage:** 40 C

**Designer:**  
Thomas O'Brien



**TOB2226PN/G1-CG**  
**Katie Large Bell**  
**Jar Sconce in**  
**Polished Nickel with**  
**Clear Glass**  
Height: 19.75"  
Width: 10.25"  
Extension: 16.5"  
Backplate:  
5.25" Round

**Finishes:** BZ, HAB, PN  
**Glass Options:**  
CG, SG, WG

**Socket:** Keyless  
**Wattage:** 40 A

**Designer:**  
Thomas O'Brien



**TOB2225HAB/G1-SG**



**TOB2226HAB/G1-SG**



**TOB2225BZ/G1-WG**



**TOB2226BZ/G1-WG**



**TOB2225PN/G3-CG**  
**Katie Small Cylinder**  
**Sconce in Polished**  
**Nickel with Clear Glass**  
Height: 16.25"  
Width: 5.25"  
Extension: 7.5"  
Backplate: 5.25" Round

**Finishes:**  
BZ, HAB, PN  
**Glass Options:**  
CG, SG, WG

**Socket:** Candelabra  
**Wattage:** 40 C

**Designer:**  
Thomas O'Brien



**TOB2226PN/G3-CG**  
**Katie Large Cylinder**  
**Sconce in Polished**  
**Nickel with Clear Glass**  
Height: 21"  
Width: 7.2"  
Extension: 15"  
Backplate: 5.25" Round

**Finishes:**  
BZ, HAB, PN  
**Glass Options:**  
CG, SG, WG

**Socket:** Keyless  
**Wattage:** 40 A

**Designer:**  
Thomas O'Brien



**TOB2225HAB/G3-SG**



**TOB2226HAB/G3-SG**



**TOB2225BZ/G3-WG**



**TOB2226BZ/G3-WG**



**TOB2225PN/G6-CG**  
**Katie Small Conical**  
**Sconce in Polished**  
**Nickel with Clear Glass**  
Height: 14.4"  
Width: 9.4"  
Extension: 10.25"  
Backplate: 5.25" Round

**Finishes:**  
BZ, HAB, PN  
**Glass Options:**  
CG, SG, WG

**Socket:** Candelabra  
**Wattage:** 40 C

**Designer:**  
Thomas O'Brien



**TOB2226PN/G6-CG**  
**Katie Large Conical**  
**Sconce in Polished**  
**Nickel with Clear Glass**  
Height: 19.75"  
Width: 16"  
Extension: 19.2"  
Backplate: 5.25" Round

**Finishes:**  
BZ, HAB, PN  
**Glass Options:**  
CG, SG, WG

**Socket:** Keyless  
**Wattage:** 40 A

**Designer:**  
Thomas O'Brien



**TOB2225HAB/G6-SG**



**TOB2226HAB/G6-SG**



**TOB2225BZ/G6-WG**



**TOB2226BZ/G6-WG**



**TOB2225PN/G4-CG**  
**Katie Small Globe**  
**Sconce in Polished**  
**Nickel with Clear Glass**  
 Height: 12.5"  
 Width: 8"  
 Extension: 9.75"  
 Backplate: 5.25" Round

**Finishes:** BZ, HAB, PN  
**Glass Options:**  
 CG, SG, WG

**Socket:** Candelabra  
**Wattage:** 40 C

**Designer:**  
 Thomas O'Brien



**TOB2226PN/G4-CG**  
**Katie Large Globe**  
**Sconce in Polished**  
**Nickel with Clear Glass**  
 Height: 19.25"  
 Width: 12"  
 Extension: 17.4"  
 Backplate: 5.25" Round

**Finishes:** BZ, HAB, PN  
**Glass Options:**  
 CG, SG, WG

**Socket:** Keyless  
**Wattage:** 40 A

**Designer:**  
 Thomas O'Brien



**TOB2225HAB/G4-SG**



**TOB2226HAB/G4-SG**



**TOB2225BZ/G4-WG**



**TOB2226BZ/G4-WG**



**TOB2225PN/G2-CG**  
**Katie Small Acorn**  
**Sconce in Polished**  
**Nickel with Clear Glass**  
Height: 13.4"  
Width: 6.5"  
Extension: 8.75"  
Backplate: 5.25" Round

**Finishes:** BZ, HAB, PN  
**Glass Options:**  
CG, SG, WG

**Socket:** Candelabra  
**Wattage:** 40 C

**Designer:**  
Thomas O'Brien



**TOB2226PN/G2-CG**  
**Katie Large Acorn**  
**Sconce in Polished**  
**Nickel with Clear Glass**  
Height: 18.25"  
Width: 10.5"  
Extension: 16.6"  
Backplate: 5.25" Round

**Finishes:** BZ, HAB, PN  
**Glass Options:**  
CG, SG, WG

**Socket:** Keyless  
**Wattage:** 40 A

**Designer:**  
Thomas O'Brien



**TOB2225HAB/G2-SG**



**TOB2226HAB/G2-SG**



**TOB2225BZ/G2-WG**



**TOB2226BZ/G2-WG**



**S2022HAB-WG**  
**Bistro Double Wall**  
**Bronze in Hand-**  
**Rubbed Antique Brass**  
**with White Glass**

Height: 32"  
Width: 6"  
Extension: 11.5"  
Backplate:  
4.5" Round

**Finishes:** HAB, PN

**Socket:**  
2 - Candelabra  
**Wattage:** 2 - 40 G

**Designer:**  
Ian Fowler





**S2024PN-CG**  
**Bistro Single Light**  
**Sconce in Polished**  
**Nickel with Clear Glass**  
Height: 11.75"  
Width: 6"  
Extension: 7.5"  
Backplate: 4.5" Round

**Finishes:**  
HAB/BLK, PN,  
PN/BLK

**Socket:** Keyless  
**Wattage:** 40 G

**Designer:**  
Ian Fowler

S2024PN/BLK-CG



S2024HAB/BLK-WG



**S2026PN-CG**  
**Bistro Double Light**  
**Curved Sconce in**  
**Hand-Rubbed Antique**  
**Brass and Black**  
**with White Glass**  
Height: 10.75"  
Width: 14"  
Extension: 7"  
Backplate: 4.5" Round

**Finishes:**  
HAB/BLK, PN,  
PN/BLK

**Socket:** 2 - Keyless  
**Wattage:** 2 - 40 G

**Designer:**  
Ian Fowler

S2026HAB/BLK-WG



**S2025HAB/BLK-WG**  
**Bistro Four Light**  
**Bath Sconce in**  
**Hand-Rubbed Antique**  
**Brass and Black**  
**with White Glass**  
Height: 10.75"  
Width: 30"  
Extension: 7"  
Backplate: 4.5" Round

**Finishes:**  
HAB/BLK, PN,  
PN/BLK

**Socket:** 4 - Keyless  
**Wattage:** 4 - 40 G

**Designer:**  
Ian Fowler



**OUTDOOR**



**DECORATIVE OUTDOOR**

**CHO2064NC**  
**Suffork Medium**  
**Scroll Arm Lantern**  
**in Natural Copper**  
Height: 22.25"  
Width: 6.75"  
Extension: 7.5"  
Backplate: 4.5" x 5"

**Finishes:** NC  
**Glass Options:** CG

**Socket:**  
2 - Candelabra  
**Wattage:** 2 - 60 C

**Designer:**  
E. F. Chapman

©EFC DESIGNS



**CHO2060NC**  
**Suffork Small**  
**3/4 Lantern in**  
**Natural Copper**  
 Height: 12.25"  
 Width: 6.75"  
 Extension: 6"  
 Backplate:  
 5.5" x 5.25"

**Finishes:** NC  
**Glass Options:** CG

**Socket:**  
 2 - Candelabra  
**Wattage:** 2 - 60 C

**Designer:**  
 E. F. Chapman

©EFC DESIGNS



**CHO2062NC**  
**Suffork Wide Short**  
**3/4 Lantern in**  
**Natural Copper**  
 Height: 18"  
 Width: 9.75"  
 Extension: 6"  
 Backplate:  
 8.25" x 8.75"

**Finishes:** NC  
**Glass Options:** CG

**Socket:**  
 2 - Candelabra  
**Wattage:** 2 - 60 C

**Designer:**  
 E. F. Chapman

©EFC DESIGNS



**CHO2065NC**  
**Suffork Tall**  
**3/4 Lantern in**  
**Natural Copper**  
 Height: 24"  
 Width: 8"  
 Extension: 6"  
 Backplate:  
 6.5" x 14.75"

**Finishes:** NC  
**Glass Options:** CG

**Socket:**  
 2 - Candelabra  
**Wattage:** 2 - 60 C

**Designer:**  
 E. F. Chapman

©EFC DESIGNS



**CHO2066NC**  
**Suffork Wide Tall**  
**Scroll 3/4 Lantern**  
**in Natural Copper**  
 Height: 24"  
 Width: 9.75"  
 Extension: 6"  
 Backplate:  
 8.25" x 14.75"

**Finishes:** NC  
**Glass Options:** CG

**Socket:**  
 2 - Candelabra  
**Wattage:** 2 - 60 C

**Designer:**  
 E. F. Chapman

©EFC DESIGNS



**CHO2063NC**  
**Suffork Medium**  
**3/4 Lantern in**  
**Natural Copper**  
Height: 18"  
Width: 6.75"  
Extension: 6"  
Backplate:  
5.25" x 11"

**Finishes:** NC  
**Glass Options:** CG

**Socket:**  
2 - Candelabra  
**Wattage:** 2 - 60 C

**Designer:**  
E. F. Chapman

©EFC DESIGNS



**CHO2061NC**  
**Suffork Small**  
**Scroll Arm Lantern**  
**in Natural Copper**  
Height: 17.75"  
Width: 6.75"  
Extension: 7.5"  
Backplate:  
4.5" Square

**Finishes:** NC  
**Glass Options:** CG

**Socket:**  
2 - Candelabra  
**Wattage:** 2 - 60 C

**Designer:**  
E. F. Chapman

©EFC DESIGNS



**CHO2064NC**  
**Suffork Medium**  
**Scroll Arm Lantern**  
**in Natural Copper**  
Height: 22.25"  
Width: 6.75"  
Extension: 7.5"  
Backplate:  
4.5" x 5"

**Finishes:** NC  
**Glass Options:** CG

**Socket:**  
2 - Candelabra  
**Wattage:** 2 - 60 C

**Designer:**  
E. F. Chapman

©EFC DESIGNS



**CHO2067NC**  
**Suffork Tall Scroll**  
**Arm Lantern in**  
**Natural Copper**  
Height: 29.25"  
Width: 8"  
Extension: 7.5"  
Backplate:  
4.5" x 5"

**Finishes:** NC  
**Glass Options:** CG

**Socket:**  
2 - Candelabra  
**Wattage:** 2 - 60 C

**Designer:**  
E. F. Chapman

©EFC DESIGNS



**CHO2150NC  
Bedford Small  
3/4 Lantern in  
Natural Copper**

Height: 12"  
Width: 6.75"  
Extension: 6"  
Backplate:  
5.25" x 5.5"

**Finishes:** NC  
**Glass Options:** CG

**Socket:**  
2 - Candelabra  
**Wattage:** 2 - 60 C

**Designer:**  
E. F. Chapman

©EFC DESIGNS



**CHO2156NC  
Bedford Wide Short  
3/4 Lantern in  
Natural Copper**

Height: 18"  
Width: 9.75"  
Extension: 6"  
Backplate:  
8.25" x 11"

**Finishes:** NC  
**Glass Options:** CG

**Socket:**  
2 - Candelabra  
**Wattage:** 2 - 60 C

**Designer:**  
E. F. Chapman

©EFC DESIGNS



**CHO2152NC  
Bedford Medium  
3/4 Lantern in  
Natural Copper**

Height: 17.25"  
Width: 6.75"  
Extension: 6"  
Backplate:  
5.25" x 8.75"

**Finishes:** NC  
**Glass Options:** CG

**Socket:**  
2 - Candelabra  
**Wattage:** 2 - 60 C

**Designer:**  
E. F. Chapman

©EFC DESIGNS



**CHO2157NC  
Bedford Wide Tall  
3/4 Lantern in  
Natural Copper**

Height: 24"  
Width: 9.75"  
Extension: 6"  
Backplate:  
8.25" x 14.75"

**Finishes:** NC  
**Glass Options:** CG

**Socket:**  
2 - Candelabra  
**Wattage:** 2 - 60 C

**Designer:**  
E. F. Chapman

©EFC DESIGNS





**CHO2154NC**  
**Bedford Large**  
**3/4 Lantern in**  
**Natural Copper**

Height: 24"  
Width: 8"  
Extension: 6"  
Backplate:  
6.5" x 14.75"

**Finishes:** NC  
**Glass Options:** CG

**Socket:**  
2 - Candelabra  
**Wattage:** 2 - 60 C

**Designer:**  
E. F. Chapman

©EFC DESIGNS



**CHO2151NC**  
**Bedford Small**  
**Scroll Arm Lantern**  
**in Natural Copper**

Height: 16.5"  
Width: 6.75"  
Extension: 7.5"  
Backplate:  
4.5" Square

**Finishes:** NC  
**Glass Options:** CG

**Socket:**  
2 - Candelabra  
**Wattage:** 2 - 60 C

**Designer:**  
E. F. Chapman

©EFC DESIGNS



**CHO2153NC**  
**Bedford Medium**  
**Scroll Arm Lantern**  
**in Natural Copper**

Height: 22.5"  
Width: 6.75"  
Extension: 7.5"  
Backplate:  
4.5" x 5"

**Finishes:** NC  
**Glass Options:** CG

**Socket:**  
2 - Candelabra  
**Wattage:** 2 - 60 C

**Designer:**  
E. F. Chapman

©EFC DESIGNS



**CHO2155NC**  
**Bedford Large**  
**Scroll Arm Lantern**  
**in Natural Copper**

Height: 29.25"  
Width: 8"  
Extension: 7.5"  
Backplate:  
4.5" x 5.5"

**Finishes:** NC  
**Glass Options:** CG

**Socket:**  
2 - Candelabra  
**Wattage:** 2 - 60 C

**Designer:**  
E. F. Chapman

©EFC DESIGNS



**CHO2222NC**  
**Somerset Small**  
**Modern Lantern in**  
**Natural Copper**  
 Height: 10.75"  
 Width: 6"  
 Extension: 6.25"  
 Backplate:  
 7.75" x 8"

**Finishes:** NC, WZ  
**Glass Options:** CG

**Socket:** Keyless  
**Wattage:** 60 A

**Designer:**  
 E. F. Chapman

©EFC DESIGNS



CHO2222WZ



**CHO2224NC**  
**Somerset Large**  
**Modern Lantern in**  
**Natural Copper**  
 Height: 17.75"  
 Width: 10"  
 Extension: 6.25"  
 Backplate:  
 8" x 14.75"

**Finishes:** NC, WZ  
**Glass Options:** CG

**Socket:** Keyless  
**Wattage:** 60 A

**Designer:**  
 E. F. Chapman

©EFC DESIGNS



CHO2224WZ







**CHD2950BLK**  
**Elsinore 3/4 Wall**  
**Lantern in Black**  
Height: 15.75"  
Width: 11"  
Extension: 7.75"  
Backplate:  
5.5" x 9.5"  
Rectangle

**Finishes:** BLK, WZ

**Socket:**  
2 - Candelabra  
**Wattage:** 2 - 60 C

**Designer:**  
E.F. Chapman

©EFC DESIGNS

CHD2950WZ



**CHD2952BLK**  
**Elsinore Bracket**  
**Lantern in Black**  
Height: 20.5"  
Width: 11"  
Extension: 11.75"  
Backplate:  
4.5" x 5" Rectangle

**Finishes:** BLK, WZ

**Socket:**  
4 - Candelabra  
**Wattage:** 4 - 60 C

**Designer:**  
E.F. Chapman

©EFC DESIGNS

CHD2952WZ



**SP2070BC**  
**Audley Small Outdoor**  
**Wall Sconce in**  
**Blackened Copper**  
**with Clear Glass**  
 Height: 18.5"  
 Width: 8.75"  
 Extension: 7.75"  
 Backplate:  
 3.25" x 6" Rectangle

**Finishes:** BC  
**Glass Options:** CG

**Socket:** 2 - Candelabra  
**Wattage:** 2 - 60 C

**Designer:**  
 J. Randall Powers



**SP2071BC**  
**Audley Medium**  
**Outdoor Wall Sconce**  
**in Blackened Copper**  
**with Clear Glass**  
 Height: 29"  
 Width: 13.75"  
 Extension: 12.25"  
 Backplate:  
 5" x 9.5" Rectangle

**Finishes:** BC  
**Glass Options:** CG

**Socket:** 4 - Candelabra  
**Wattage:** 4 - 60 C

**Designer:**  
 J. Randall Powers



**SP2075BC**  
**Audley Small Harped**  
**Outdoor Wall Sconce**  
**in Blackened Copper**  
**with Clear Glass**  
 Height: 18.5"  
 Width: 8.75"  
 Extension: 11.25"  
 Backplate:  
 3.5" x 4.75" Rectangle

**Finishes:** BC  
**Glass Options:** CG

**Socket:** 2 - Candelabra  
**Wattage:** 2 - 60 C

**Designer:**  
 J. Randall Powers



**SP2076BC**  
**Audley Medium**  
**Harped Outdoor**  
**Wall Sconce in**  
**Blackened Copper**  
**with Clear Glass**  
 Height: 29.5"  
 Width: 13.75"  
 Extension: 17.25"  
 Backplate:  
 5.5" x 7.25" Rectangle

**Finishes:** BC  
**Glass Options:** CG

**Socket:** 4 - Candelabra  
**Wattage:** 4 - 60 C

**Designer:**  
 J. Randall Powers



**SP2077BC**  
**Audley Large Forked**  
**Bracket Outdoor**  
**Wall Sconce in**  
**Blackened Copper**  
**with Clear Glass**  
 Height: 33.25"  
 Width: 18.75"  
 Extension: 23"  
 Backplate:  
 7.25" x 9.5" Rectangle

**Finishes:** BC  
**Glass Options:** CG

**Socket:**  
 4 - Candelabra  
**Wattage:** 4 - 60 C

**Designer:**  
 J. Randall Powers



**SP5071BC**  
**Audley Medium Outdoor**  
**Hanging Lantern in**  
**Blackened Copper**  
**with Clear Glass**  
Height: 26.75"  
Width: 13.75"  
Canopy: 5" Round

**Finishes:** BC  
**Glass Options:** CG

**Socket:** 4 - Candelabra  
**Wattage:** 4 - 60 C

**Designer:**  
J. Randall Powers



**SP5072BC**  
**Audley Large Hanging**  
**Outdoor Lantern in**  
**Blackened Copper**  
**with Clear Glass**  
Height: 33.5"  
Width: 18.5"  
Canopy: 5" Round

**Finishes:** BC  
**Glass Options:** CG

**Socket:** 4 - Candelabra  
**Wattage:** 4 - 60 C

**Designer:**  
J. Randall Powers



**SP7071BC**  
**Audley Medium**  
**Outdoor Post Lantern**  
**in Blackened Copper**  
**with Clear Glass**  
Height: 29"  
Width: 13.75"  
Extension: 12.25"  
Base: 3" Post

**Finishes:** BC  
**Glass Options:** CG

**Socket:** 4 - Candelabra  
**Wattage:** 4 - 60 C

**Note:** Requires a  
Smaller Outlet Box

**Designer:**  
J. Randall Powers



**SP7072BC**  
**Audley Large Outdoor**  
**Post Lantern in**  
**Blackened Copper**  
**with Clear Glass**  
Height: 36.75"  
Width: 18.5"  
Base: 3" Post

**Finishes:** BC  
**Glass Options:** CG

**Socket:** 4 - Candelabra  
**Wattage:** 4 - 60 C

**Note:** Requires a  
Smaller Outlet Box

**Designer:**  
J. Randall Powers



**CHO2800BZ**  
**Kensington Mini Wall**  
**Lantern in Bronze**  
Height: 9"  
Width: 5.75"  
Extension: 4.75"  
Backplate:  
5" x 6.5" Rectangle

**Finishes:** BZ  
**Glass Options:** CG

**Socket:** Candelabra  
**Wattage:** 60 C

**Designer:**  
E. F. Chapman

©EFC DESIGNS





**CHO2802BZ**  
**Kensington Medium**  
**Wall Lantern**  
**in Bronze**  
Height: 14"  
Width: 9.5"  
Extension: 7"  
Backplate:  
8.5" x 10"  
Rectangle

**Finishes:** BZ  
**Glass Options:** CG

**Socket:**  
2 - Candelabra  
**Wattage:** 2 - 60 C

**Designer:**  
E. F. Chapman

©EFC DESIGNS



**CHO2803BZ**  
**Kensington Large Wall**  
**Lantern in Bronze**  
Height: 19.5"  
Width: 11.5"  
Extension: 8.25"  
Backplate:  
9" x 14" Rectangle

**Finishes:** BZ  
**Glass Options:** CG

**Socket:**  
3 - Candelabra  
**Wattage:** 3 - 60 C

**Designer:**  
E. F. Chapman

©EFC DESIGNS



**CHO5802BZ**  
**Kensington Medium**  
**Hanging Lantern**  
**in Bronze**  
Height: 16.5"  
Width: 9.5"  
Canopy:  
5.5" Round

**Finishes:** BZ  
**Glass Options:** CG

**Socket:**  
4 - Candelabra  
**Wattage:** 4 - 60 C

**Designer:**  
E. F. Chapman

©EFC DESIGNS



**CHO7802BZ**  
**Kensington Medium**  
**Post Lantern**  
**in Bronze**  
Height: 17"  
Width: 9.5"  
Base: 3" Post

**Finishes:** BZ  
**Glass Options:** CG

**Socket:**  
4 - Candelabra  
**Wattage:** 4 - 60 C

**Designer:**  
E. F. Chapman

©EFC DESIGNS



**CHO2400BZ  
Club Door Large  
Lantern in Bronze**

Height: 24.5"  
Width: 8.25"  
Extension: 5.25"

**Finishes:** BZ  
**Glass Options:** CG

**Socket:**  
2 - Candelabra  
**Wattage:** 2 - 60 C

**Designer:**  
E. F. Chapman

©EFC DESIGNS



**CHO2401BZ  
Club Door Small  
Lantern in Bronze**

Height: 14"  
Width: 6.25"  
Extension: 4.5"  
Backplate:  
4.75" x 9"

**Finishes:** BZ  
**Glass Options:** CG

**Socket:**  
2 - Candelabra  
**Wattage:** 2 - 60 C

**Designer:**  
E. F. Chapman

©EFC DESIGNS



**CHO2500BZ  
Club Door Lantern  
in Bronze**

Height: 18.5"  
Width: 10"  
Extension: 5.5"  
Backplate: 4" Round

**Finishes:** BZ  
**Glass Options:** CG

**Socket:**  
2 - Candelabra  
**Wattage:** 2 - 60 C

**Designer:**  
E. F. Chapman

©EFC DESIGNS



**CHO2034BZ**  
**Sussex Small 3/4**  
**Lantern in Bronze**  
Height: 19"  
Width: 9.5"  
Extension: 8.25"

**Finishes:** BZ  
**Glass Options:** CG

**Socket:**  
3 - Candelabra  
**Wattage:** 3 - 60 C

**Designer:**  
E. F. Chapman

©EFC DESIGNS



**CHO2031BZ**  
**Sussex Small Bracket**  
**Lantern in Bronze**  
Height: 22.25"  
Width: 9.5"  
Extension: 11.5"  
Backplate: 4.5" x 5"

**Finishes:** BZ  
**Glass Options:** CG

**Socket:**  
3 - Candelabra  
**Wattage:** 3 - 60 C

**Designer:**  
E. F. Chapman

©EFC DESIGNS



**CHO2035BZ**  
**Sussex Medium 3/4**  
**Lantern in Bronze**  
Height: 24"  
Width: 12"  
Extension: 11"

**Finishes:** BZ  
**Glass Options:** CG

**Socket:**  
3 - Candelabra  
**Wattage:** 3 - 60 C

**Designer:**  
E. F. Chapman

©EFC DESIGNS



**CHO2032BZ**  
**Sussex Medium Bracket**  
**Lantern in Bronze**  
Height: 27.25"  
Width: 12.25"  
Extension: 13"  
Backplate: 4.5" x 6"

**Finishes:** BZ  
**Glass Options:** CG

**Socket:**  
3 - Candelabra  
**Wattage:** 3 - 60 C

**Designer:**  
E. F. Chapman

©EFC DESIGNS



**CHO2038BZ**  
**Sussex Medium**  
**Extended Bracket**  
**Lantern in Bronze on**  
**Black Rust Mount**  
 Height: 38.5"  
 Width: 12.5"  
 Extension: 13"  
 Backplate: 4.5" x 6"

**Finishes:** BZ  
**Glass Options:** CG

**Socket:**  
 3 - Candelabra  
**Wattage:** 3 - 60 C

**Designer:**  
 E. F. Chapman

©EFC DESIGNS



**CHO2036BZ**  
**Sussex Large 3/4**  
**Lantern in Bronze**  
 Height: 31"  
 Width: 16"  
 Extension: 14.5"

**Finishes:** BZ  
**Glass Options:** CG

**Socket:**  
 3 - Candelabra  
**Wattage:** 3 - 60 C

**Designer:**  
 E. F. Chapman

©EFC DESIGNS



**CHO2033BZ**  
**Sussex Large Bracket**  
**Lantern in Bronze**  
 Height: 36"  
 Width: 16"  
 Extension: 17"  
 Backplate: 7" x 5"

**Finishes:** BZ  
**Glass Options:** CG

**Socket:**  
 3 - Candelabra  
**Wattage:** 3 - 60 C

**Designer:**  
 E. F. Chapman

©EFC DESIGNS



**CHO5033BZ**  
**Sussex Large Hanging**  
**Lantern in Bronze**

Height: 33"  
Width: 16"  
Canopy: 5.5" Round

**Finishes:** BZ  
**Glass Options:** CG

**Socket:**  
4 - Candelabra  
**Wattage:** 4 - 60 C

**Designer:**  
E. F. Chapman

©EFC DESIGNS



**CHO5031BZ**  
**Sussex Small**  
**Hanging Lantern**  
**in Bronze**

Height: 20.5"  
Width: 9.5"  
Canopy: 5.5" Round

**Finishes:** BZ  
**Glass Options:** CG

**Socket:**  
3 - Candelabra  
**Wattage:** 3 - 60 C

**Designer:**  
E. F. Chapman

©EFC DESIGNS



**CHO5032BZ**  
**Sussex Medium**  
**Hanging Lantern**  
**in Bronze**

Height: 26"  
Width: 12.25"  
Canopy: 5.5" Round

**Finishes:** BZ  
**Glass Options:** CG

**Socket:**  
3 - Candelabra  
**Wattage:** 3 - 60 C

**Designer:**  
E. F. Chapman

©EFC DESIGNS



**CHO7031BZ**  
**Sussex Small Post**  
**Lantern in Bronze**  
 Height: 23.5"  
 Width: 9.5"  
 Base: 3" Round  
 Post Cap

**Finishes:** BZ  
**Glass Options:** CG

**Socket:** 3 - Candelabra  
**Wattage:** 3 - 60 C

**Note:** Requires a  
 Smaller Outlet Box

**Designer:**  
 E. F. Chapman

©EFC DESIGNS



**CHO7033BZ**  
**Sussex Large Post**  
**Lantern in Bronze**  
 Height: 37.75"  
 Width: 16"  
 Base: 3" Round  
 Post Cap

**Finishes:** BZ  
**Glass Options:** CG

**Socket:** 3 - Candelabra  
**Wattage:** 3 - 60 C

**Note:** Requires a  
 Smaller Outlet Box

**Designer:**  
 E. F. Chapman

©EFC DESIGNS



**CHO7032BZ**  
**Sussex Medium Post**  
**Lantern in Bronze**  
 Height: 30.25"  
 Width: 12.25"  
 Base: 3" Round  
 Post Cap

**Finishes:** BZ  
**Glass Options:** CG

**Socket:** 3 - Candelabra  
**Wattage:** 3 - 60 C

**Note:** Requires a  
 Smaller Outlet Box

**Designer:**  
 E. F. Chapman

©EFC DESIGNS



**CHO2109BZ**  
**Chelsea Small**  
**3/4 Wall Lantern**  
**in Bronze**  
Height: 14"  
Width: 7"  
Extension: 7.5"

**Finishes:** BZ  
**Glass Options:** CG

**Socket:**  
Candelabra  
**Wattage:** 60 C

**Designer:**  
E. F. Chapman

©EFC DESIGNS



**CHO2110BZ**  
**Chelsea Small**  
**Lantern in Bronze**  
Height: 18.5"  
Width: 7"  
Extension: 11.75"  
Backplate: 4" x 5.5"

**Finishes:** BZ  
**Glass Options:** CG

**Socket:** Candelabra  
**Wattage:** 60 C

**Designer:**  
E. F. Chapman

©EFC DESIGNS



**CHO2111BZ**  
**Chelsea Lantern**  
**in Bronze**  
Height: 24.5"  
Width: 9"  
Extension: 15.25"  
Backplate: 4" x 6"

**Finishes:** BZ  
**Glass Options:** CG

**Socket:**  
3 - Candelabra  
**Wattage:** 3 - 60 C

**Designer:**  
E. F. Chapman

©EFC DESIGNS



**CHO2113BZ**  
**Chelsea Lantern**  
**in Bronze**  
Height: 31"  
Width: 9.25"  
Extension: 13.25"  
Backplate: 4.75" x 9"

**Finishes:** BZ  
**Glass Options:** CG

**Socket:**  
3 - Candelabra  
**Wattage:** 3 - 60 C

**Designer:**  
E. F. Chapman

©EFC DESIGNS



**CHO2112BZ**  
**Chelsea Large**  
**Lantern in Bronze**  
Height: 31.5"  
Width: 12"  
Extension: 18.5"  
Backplate: 5.5" x 7"

**Finishes:** BZ  
**Glass Options:** CG

**Socket:**  
3 - Candelabra  
**Wattage:** 3 - 60 C

**Designer:**  
E. F. Chapman

©EFC DESIGNS





**CHO7110BZ**  
**Chelsea Medium Post**  
**Lantern in Bronze**

Height: 23.75"  
Width: 9"  
Base: 3" Post

**Finishes:** BZ  
**Glass Options:** CG

**Socket:** 3 - Candelabra  
**Wattage:** 3 - 60 C

**Note:** Requires a  
Smaller Outlet Box

**Designer:**  
E. F. Chapman

©EFC DESIGNS



**CHO5003BZ**  
**Chelsea Medium**  
**Hanging Lantern**  
**in Bronze**

Height: 20.5"  
Width: 9"  
Canopy: 5.5" Round

**Finishes:** BZ  
**Glass Options:** CG

**Socket:**  
3 - Candelabra  
**Wattage:** 3 - 60 C

**Designer:**  
E. F. Chapman

©EFC DESIGNS



**CHO7111BZ**  
**Chelsea Large Post**  
**Lantern in Bronze**

Height: 29.5"  
Width: 12"  
Base: 3" Post Cap

**Finishes:** BZ  
**Glass Options:** CG

**Socket:**  
3 - Candelabra  
**Wattage:** 3 - 60 C

**Note:** Requires a  
Smaller Outlet Box

**Designer:**  
E. F. Chapman

©EFC DESIGNS



**CHO2040BZ**  
**Darlana Small**  
**Outdoor 3/4**  
**Lantern in Bronze**  
 Height: 14"  
 Width: 9.75"  
 Extension: 7.25"  
 Backplate:  
 9.25" x 10.25"  
 Rectangle

**Finishes:** BZ  
**Glass Options:** CG

**Socket:**  
 2 - Candelabra  
**Wattage:** 2 - 60 C

**Designer:**  
 E. F. Chapman

©EFC DESIGNS



**CHO2084BZ**  
**Darlana Medium**  
**Outdoor 3/4**  
**Lantern in Bronze**  
 Height: 18.5"  
 Width: 12.5"  
 Extension: 9.25"  
 Backplate:  
 8.75" x 11.75"  
 Rectangle

**Finishes:** BZ  
**Glass Options:** CG

**Socket:**  
 3 - Candelabra  
**Wattage:** 3 - 60 C

**Designer:**  
 E. F. Chapman

©EFC DESIGNS



**CHO2041BZ**  
**Darlana Large**  
**Outdoor 3/4 Lantern**  
**in Bronze**  
 Height: 24.5"  
 Width: 17"  
 Extension: 12.25"  
 Backplate:  
 16" x 18.25" Rectangle

**Finishes:** BZ  
**Glass Options:** CG

**Socket:**  
 3 - Candelabra  
**Wattage:** 3 - 60 C

**Designer:**  
 E. F. Chapman

©EFC DESIGNS



**CHO2042BZ**  
**Darlana Grande**  
**Outdoor 3/4 Lantern**  
**in Bronze**  
 Height: 34"  
 Width: 24.5"  
 Extension: 16.5"  
 Backplate:  
 23" x 25.75" Rectangle

**Finishes:** BZ  
**Glass Options:**  
 CG

**Socket:**  
 3 - Candelabra  
**Wattage:** 3 - 60 C

**Designer:**  
 E. F. Chapman

©EFC DESIGNS



**CHO2085BZ**  
**Dariana Medium**  
**Outdoor Bracket**  
**Lantern in Bronze**  
Height: 21.25"  
Width: 12.5"  
Extension: 14.25"  
Backplate:  
4" x 13" Rectangle

**Finishes:** BZ  
**Glass Options:** CG

**Socket:**  
4 - Candelabra  
**Wattage:** 4 - 40 C

**Designer:**  
E. F. Chapman

©EFC DESIGNS



**CHO2087BZ**  
**Darlana Tall 3/4**  
**Wall Lantern**  
**in Bronze**  
Height: 18.5"  
Width: 7.5"  
Extension: 6.75"  
Backplate:  
6.75" x 13.5" Rectangle

**Finishes:** BZ  
**Glass Options:** CG

**Socket:**  
2 - Candelabra  
**Wattage:** 2 - 60 C

**Designer:**  
E. F. Chapman

©EFC DESIGNS



**CHO2043BZ**  
**Darlana Large**  
**Outdoor Bracket**  
**Lantern in Bronze**  
Height: 28.25"  
Width: 17"  
Extension: 19"  
Backplate:  
4.5" x 17.25" Rectangle

**Finishes:** BZ  
**Glass Options:** CG

**Socket:**  
4 - Candelabra  
**Wattage:** 4 - 60 C

**Designer:**  
E. F. Chapman

©EFC DESIGNS



**CHO2086BZ**  
**Darlana Tall**  
**Bracketed Wall**  
**Lantern in Bronze**  
Height: 21.25"  
Width: 7.5"  
Extension: 9.75"  
Backplate:  
4" x 13" Rectangle

**Finishes:** BZ  
**Glass Options:** CG

**Socket:**  
2 - Candelabra  
**Wattage:** 2 - 60 C

**Designer:**  
E. F. Chapman

©EFC DESIGNS



**CHO2044BZ**  
**Darlana Grande**  
**Outdoor Bracket**  
**Lantern in Bronze**  
Height: 39"  
Width: 24.5"  
Extension: 26.5"  
Backplate:  
5" x 23.75" Rectangle

**Finishes:** BZ  
**Glass Options:** CG

**Socket:**  
6 - Candelabra  
**Wattage:** 6 - 60 C

**Designer:**  
E. F. Chapman

©EFC DESIGNS



**CHO5084BZ**  
**Darlana Small**  
**Outdoor Hanging**  
**Lantern in Bronze**  
Height: 18.5"  
Width: 12.5"  
Canopy: 6" Round

**Finishes:** BZ  
**Glass Options:** CG

**Socket:** 4 - Candelabra  
**Wattage:** 4 - 60 C

**Designer:**  
E. F. Chapman

©EFC DESIGNS



**CHO5085BZ**  
**Darlana Medium**  
**Outdoor Hanging**  
**Lantern in Bronze**  
Height: 24.5"  
Width: 17"  
Canopy: 6" Round

**Finishes:** BZ  
**Glass Options:** CG

**Socket:** 4 - Candelabra  
**Wattage:** 4 - 60 C

**Designer:**  
E. F. Chapman

©EFC DESIGNS



**CHO7113BZ**  
**Darlana Outdoor Post**  
**Light in Bronze**  
Height: 31"  
Width: 17"  
Base: 3" Post

**Finishes:** BZ  
**Glass Options:** CG

**Socket:** 4 - Candelabra  
**Wattage:** 4 - 60 C

**Designer:**  
E. F. Chapman

©EFC DESIGNS



**CHD2933AI-CG**  
**Fresno Framed Medium**  
**Scence in Aged Iron**  
**with Clear Glass**

Height: 17.75"

Width: 6"

Extension: 9"

Backplate:

4.25" X 12" Rectangle

**Finishes:** AI, WZ

**Glass Options:** CG

**Socket:** Keyless

**Wattage:** 60 T

**Designer:**

E. F. Chapman

©EFC DESIGNS



**CHD2930WZ-CG**  
**Fresno Framed Short Sconce in Weathered Zinc with Clear Glass**  
Height: 10.5"  
Width: 5"  
Extension: 8"  
Backplate:  
4.25" X 6" Rectangle

**Finishes:** AI, WZ  
**Glass Options:** CG

**Socket:** Keyless  
**Wattage:** 60 A

**Designer:**  
E. F. Chapman

©EFC DESIGNS



**CHD2936AI-CG**  
**Fresno Long Wall Sconce in Aged Iron with Clear Glass**  
Height: 29.75"  
Width: 9"  
Extension: 12"  
Backplate:  
4.25" X 12" Rectangle

**Finishes:** AI, WZ  
**Glass Options:** CG

**Socket:** Keyless  
**Wattage:** 60 T

**Designer:**  
E. F. Chapman

©EFC DESIGNS



**CHD2935WZ-CG**  
**Fresno Framed Long Sconce in Weathered Zinc with Clear Glass**  
Height: 21.75"  
Width: 6"  
Extension: 9"  
Backplate:  
4.25" X 12" Rectangle

**Finishes:** AI, WZ  
**Glass Options:** CG

**Socket:** Keyless  
**Wattage:** 60 T

**Designer:**  
E. F. Chapman

©EFC DESIGNS

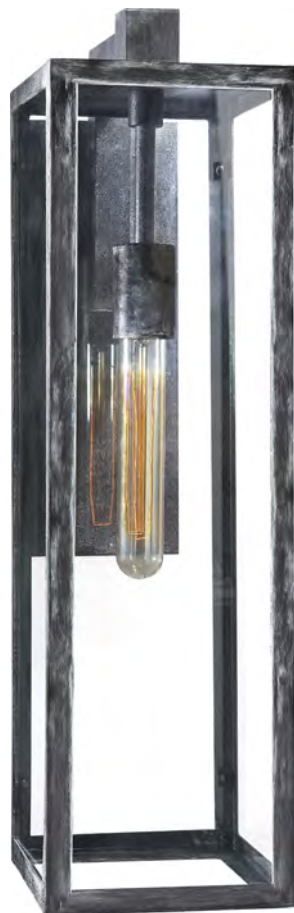

**CHO2908WZ**  
**Linear Lantern Short**  
**in Weathered Zinc**  
Height: 15"  
Width: 9"  
Extension: 5"  
Backplate:  
9" x 13" Rectangle

**Finishes:**  
AB, AN, BZ, PN, WZ  
**Glass Options:** CG

**Socket:**  
2 - Candelabra  
**Wattage:** 2 - 60 C

**Designer:**  
E. F. Chapman

©EFC DESIGNS



CHO2908BZ



**CHO2910WZ**  
**Linear Lantern Tall**  
**in Weathered Zinc**  
Height: 22.5"  
Width: 9"  
Extension: 5"  
Backplate:  
9" x 20" Rectangle

**Finishes:**  
AB, AN, BZ, PN, WZ  
**Glass Options:** CG

**Socket:**  
2 - Candelabra  
**Wattage:** 2 - 60 C

**Designer:**  
E. F. Chapman

©EFC DESIGNS



CHO2910BZ







**BBL2061BZ-FG**  
**Normandy Small**  
**Flat Top Sconce**  
**in Bronze with**  
**Frosted Glass**  
 Height: 11.5"  
 Width: 5.75"  
 Extension: 4.5"  
 Backplate:  
 5.75" x 11.5" Rectangle

**Finishes:** BZ  
**Glass Options:** FG

**Socket:** Candelabra  
**Wattage:** 60 C

**Designer:**  
 Barbara Barry



**BBL2063BZ-FG**  
**Normandy Large**  
**Flat Top Sconce**  
**in Bronze with**  
**Frosted Glass**  
 Height: 14.5"  
 Width: 7.75"  
 Extension: 5.5"  
 Backplate:  
 7.75" x 14.25"  
 Rectangle

**Finishes:** BZ  
**Glass Options:** FG

**Socket:** Candelabra  
**Wattage:** 60 C

**Designer:**  
 Barbara Barry



**BBL2070BZ-FG**  
**Ojai Small Sconce**  
**in Bronze with**  
**Frosted Glass**  
 Height: 14.25"  
 Width: 7"  
 Extension: 8.5"  
 Backplate: 4" Square

**Finishes:** BZ, PN  
**Glass Options:** FG

**Socket:** Keyless  
**Wattage:** 60 A

**Designer:**  
 Barbara Barry



**BBL2072BZ-FG**  
**Ojai Large Sconce**  
**in Bronze with**  
**Frosted Glass**  
 Height: 17.75"  
 Width: 8"  
 Extension: 10"  
 Backplate: 4" Square

**Finishes:** BZ, PN  
**Glass Options:** FG

**Socket:** Keyless  
**Wattage:** 60 A

**Designer:**  
 Barbara Barry





**BBL4065BZ-FG**  
**Normandy Small Flush**  
**Mount in Bronze**  
**with Frosted Glass**  
 Height: 8.25"  
 Width: 11"

**Finishes:** BZ  
**Glass Options:** FG

**Socket:**  
 3 - Candelabra  
**Wattage:** 3 - 60 C

**Designer:**  
 Barbara Barry



**BBL4066BZ-FG**  
**Normandy Large Flush**  
**Mount in Bronze**  
**with Frosted Glass**  
 Height: 8.25"  
 Width: 15"

**Finishes:** BZ  
**Glass Options:** FG

**Socket:**  
 3 - Candelabra  
**Wattage:** 3 - 60 C

**Designer:**  
 Barbara Barry



**BBL2060BZ-FG**  
**Normandy Small**  
**Sconce in Bronze**  
**with Frosted Glass**  
 Height: 15.75"  
 Width: 6.75"  
 Extension: 4.5"  
 Backplate:  
 6.5" x 11.75"  
 Rectangle

**Finishes:** BZ  
**Glass Options:** FG

**Socket:** Candelabra  
**Wattage:** 60 C

**Designer:**  
 Barbara Barry



**BBL2062BZ-FG**  
**Normandy Large**  
**Sconce in Bronze**  
**with Frosted Glass**  
 Height: 21"  
 Width: 9.25"  
 Extension: 5.5"  
 Backplate:  
 7.75" x 14.25"  
 Rectangle

**Finishes:** BZ  
**Glass Options:** FG

**Socket:** Candelabra  
**Wattage:** 60 C

**Designer:**  
 Barbara Barry



**BBL5065BZ-FG**  
**Normandy Lantern**  
**in Bronze with**  
**Frosted Glass**  
Height: 27.25"  
Width: 14.5"  
Canopy: 6.5" Round

**Finishes:** BZ  
**Glass Options:** FG

**Socket:** 3 - Keyless  
**Wattage:** 3 - 60 B

**Designer:**  
Barbara Barry



**SLO4000WZ-SG**  
Marine Indoor/  
Outdoor Flush  
Mount Light in  
Weathered Zinc  
with Seeded Glass  
Height: 10.5"  
Width: 6"

**Finishes:**  
BZ, CH, WZ  
**Glass Options:**  
CG, SG

**Socket:** Keyless  
**Wattage:** 60 A

**Note:** Bulb Sold  
Separately (B-30M)

**Designer:**  
E. F. Chapman

©EFC DESIGNS



SLO4000BZ-SG



**SLO4002WZ-SG**  
Marine Medium  
Flush Mount in  
Weathered Zinc  
with Seeded Glass  
Height: 15"  
Width: 12"

**Finishes:** BZ, CH, WZ  
**Glass Options:**  
CG, SG

**Socket:** Keyless  
**Wattage:** 60 A

**Note:** Bulb Sold  
Separately (B-30M)

**Designer:**  
E. F. Chapman

©EFC DESIGNS



SLO4002BZ-SG



**SLO2001WZ-SG**  
Marine Indoor/  
Outdoor Wall Light  
in Weathered Zinc  
with Seeded Glass  
Height: 10.5"  
Width: 8.5"  
Extension: 10"  
Backplate:  
4.5" x 6.5" Rectangle

**Finishes:** BZ, CH, WZ  
**Glass Options:**  
CG, SG

**Socket:** Keyless  
**Wattage:** 60 A

**Note:** Bulb Sold  
Separately (B-30M)

**Designer:**  
E. F. Chapman

©EFC DESIGNS



SLO2001BZ-SG



**SLO2003BZ-SG**  
**Marine Medium Wall**  
**Light in Bronze**  
**with Seeded Glass**  
Height: 16.25"  
Width: 12"  
Backplate: 6" Round

**Finishes:**  
BZ, CH, WZ  
**Glass Options:**  
CG, SG

**Socket:** Keyless  
**Wattage:** 60 A

**Note:** Bulb Sold  
Separately (B-30M)

**Designer:**  
E. F. Chapman

©EFC DESIGNS



# **FINISHES**







Our “living” finishes make the difference for lighting choices that are unique in personality and design appeal. **We use authentic natural materials to give our products their custom character:** brass, bronze, nickel, silver and chrome in antique and polished lusters; classic enamels, ceramic, porcelain and gilding; forged irons and honed woods; hand blown glass; rock crystal and alabaster; elegant parchment papers, silks and linens.

Our selection of more than eighty finishes is a central part of our promise to serve all aesthetic preferences and design applications in our lighting.

These abundant options can help you adapt your favorite lighting profiles to the right mood for your project. From the superior quality of our Hand-Rubbed Antique Brass and Polished Nickel to the perfect elegance of Gilded Iron and Antique Silver Leaf, and many more casual and painted finishes in between, we have the look that will help you create your own lighting décor.

SIGNATURE FINISHES



Aged Iron



Alabaster



Antique Brass



Antique Nickel



Antique Silver



Antique White



Antique Zinc



Belgian White

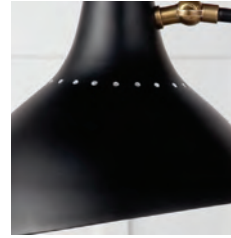

Black



Black Marble



Blackend Rust



Blue Lagoon

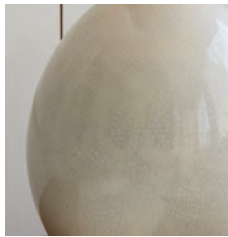

Bone Craquelure



Bronze



Burnished Silver Leaf



Celadon Crackle



Crystal



Drizzled Cobalt



Ebonized Oak



French Waxed Wood



Garden Stone



Gild



Gilded Iron



Gilded Wood



Green Marble



Hand Painted Rust



Ivory Porcelain



Marbled Sienna



Mercury Glass



Natural Copper

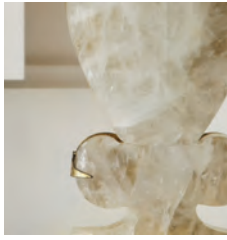

Natural Quartz Stone



Old White



Pebbled Aquamarine



Pewter



Plaster White



Polished Nickel



Polished Silver



Sheffield Nickel



Sheffield Silver

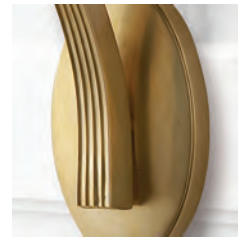

Soft Brass



Soft Silver



Tea Stain Crackle



Tudor Brown Stain



Verdigris



Vintage Steel



Volcanic Ivory



Weathered Gold Leaf



Weathered Iron



Weathered Zinc



White



A modern chandelier with a polished chrome finish and six curved arms, each holding a white cylindrical shade. It hangs from a chain in the center of the room.

A large, octagonal mirror with a faceted, geometric frame, reflecting the room's light and decor.

A white ceramic vase filled with white orchids, placed on the console table.

A stack of three books on the console table. The top book is titled "Herman to the Manor Richard Jordan" and the bottom book is "MULLINGSTONE - THE PHOTOGRAPHS".

A modern armchair with a white upholstered seat and backrest, and a polished chrome frame with curved armrests.

A tall floor lamp with a white cylindrical shade and a polished chrome stand, positioned near the window.

A white, shaggy area rug placed on the floor under the armchair and console table.



## LAMP AND FIXTURE FINISH CODES

<b>AB</b>	Antique-Burnished Brass
<b>ABV</b>	Antique Brass with Verde
<b>AGP</b>	Antique Gild and Polychrome
<b>AGW</b>	Antique Gilded Wood
<b>AI</b>	Aged Iron
<b>AI/HAB</b>	Aged Iron
<b>ALB</b>	Alabaster
<b>AM</b>	Antique Mirror
<b>AM/HAB</b>	Antique Mirror
<b>AN</b>	Antique Nickel
<b>AS</b>	Antique Silver
<b>AW</b>	Antique White
<b>AZ</b>	Antique Zinc
<b>BC</b>	Brushed Chrome
<b>BCB</b>	Black and Crystal Bronze Dot
<b>BGG</b>	Burnt Gold with Dove Grey
<b>BGW</b>	Burnt Gold with White Porous
<b>BLC</b>	Blue Celadon
<b>BLK</b>	Black Porcelain
<b>BLK/PN</b>	Polished Nickel with Black
<b>BLL</b>	Blue Lagoon
<b>BM</b>	Black Marble
<b>BN</b>	Brushed Nickel
<b>BR</b>	Blackened Rust
<b>BRM</b>	Brown Marble
<b>BS</b>	Brushed Steel
<b>BSL</b>	Burnished Silver Leaf
<b>BT</b>	Bone Tile
<b>BW</b>	Belgian White
<b>BWV</b>	Blue Wave
<b>BYR</b>	Berry Red
<b>BZ</b>	Bronze
<b>BZ/AB</b>	Bronze with Antique Brass
<b>BZ/HAB</b>	Bronze with Antique Brass
<b>BZV</b>	Bronze
<b>C</b>	Charcoal
<b>CC</b>	Celadon Crackle
<b>CG</b>	Crystal
<b>CG/PN</b>	Crystal with Polished Nickel
<b>CH</b>	Chrome
<b>CHW</b>	Chalk White
<b>CU</b>	Custard Stoneware
<b>CW</b>	China White
<b>DC</b>	Drizzled Cobalt
<b>DM</b>	Denim Porcelain
<b>DW</b>	Dark Walnut
<b>EB</b>	Stained Ebony
<b>EBO</b>	Ebonized Oak
<b>ESP</b>	Espresso Leather
<b>FG</b>	French Gild Silver and Gold
<b>FP</b>	Fire Pot Ceramic
<b>FW</b>	French Waxed Wood
<b>G</b>	Gild
<b>GDA</b>	Matte Stone Grey and Dotty Anglia
<b>GI</b>	Gilded Iron
<b>GM</b>	Gun Metal
<b>GRM</b>	Green Marble
<b>GRN</b>	Green Porcelain
<b>GS</b>	Garden Stone
<b>GW</b>	Gilded Wood
<b>GY</b>	Gray
<b>HAB</b>	Hand-Rubbed Antique Brass
<b>HAB/BLK</b>	Hand-Rubbed Antique Brass and Black
<b>HAB/BZ</b>	Antique Brass with Bronze
<b>HAB/CG</b>	Hand-Rubbed Antique Brass with Crystal

## SHADE, TRIM AND GLASS FINISH CODES

<b>AB</b>	Antique Brass
<b>ALB</b>	Alabaster
<b>AM</b>	Antique Mirror
<b>AMB</b>	Amber Glass
<b>AMT</b>	Amethyst Glass
<b>B</b>	Black Paper (Tortoise Lining)
<b>BL</b>	Light Blue Linen
<b>C</b>	White Cotton
<b>C/BT</b>	White Cotton with Dark Brown Tape
<b>CD</b>	Clouded Glass
<b>CG</b>	Crystal or Clear Glass
<b>CGQ</b>	Crystal and Quartz Trim
<b>CRG</b>	Crackle Glass
<b>FA</b>	Frosted Acrylic
<b>FG</b>	Frosted Glass
<b>FR</b>	Fractured Glass
<b>FS</b>	Fawn Silk
<b>GS</b>	Gray Silk
<b>L</b>	Linen
<b>LC</b>	Linen Pleat with Crown Top
<b>LCC</b>	Linen Pleat with Crown Top and Collar Bottom
<b>LCF</b>	Linen Pleat with Crown Top and Metal Frame
<b>MG</b>	Mercury Glass
<b>NP</b>	Natural Paper
<b>NP/BT</b>	Natural Paper with Black Trim
<b>NP/RT</b>	Natural Paper with Rust Tape
<b>NP/ST</b>	Natural Paper with Silver Tape
<b>OX</b>	Oxblood Patina Paint
<b>PL</b>	Natural Percale
<b>S</b>	Silk
<b>SBP</b>	Silk Box Pleat
<b>SC</b>	Silk Pleat with Crown or Collar
<b>SG</b>	Clear Seeded Glass
<b>T</b>	Eggshell Tissue Silk
<b>TL</b>	Tan Linen
<b>TSBC</b>	Tea Stained Silk Bell with Collar
<b>WG</b>	White Glass
<b>WP/ST</b>	White Paper with Silver Trim



**CHANDELIER AND  
SCONCE SHADES**



**CHS104B**  
Black Paper  
3" x 4 1/4" x 4"



**CHS104L**  
Linen  
3" x 4 1/4" x 4"



**CHS104NP**  
Natural Paper  
3" x 4 1/4" x 4"



**CHS104S**  
Silk Pleat  
3" x 4 1/4" x 4"



**CHS106L**  
Linen  
3" x 6" x 4 1/4"



**CHS106NP**  
Natural Paper  
3" x 6" x 4 1/4"



**CHS109S**  
Silk Bell  
2 1/2" x 5" x 4 1/2"



**CHS111S**  
Silk Pleated Shield  
4" x 5 1/2"



**CHS112NP**  
Natural Paper  
4" x 9" x 6"



**CHS112S**  
Silk Pleat  
4" x 5" x 5"



**CHS114NP**  
Natural Paper  
4" x 6" x 5"



**CHS113S**  
Silk Square  
3 1/2" x 5" x 5"

**CARE INSTRUCTIONS**

All products should be cleaned with a soft, dry cloth or duster. Our products should never be sprayed with a cleaning solution or polish. When it is necessary to use a cleaning agent, please apply only a mild detergent to a soft, damp cloth for gentle cleansing. Do not use scouring agents, abrasive sponges, hydrochloric acid, vinegar, ammonia, petroleum distillate or metal silicates.

**CUSTOMIZATION**

Many of our products can be modified in our custom department. Changing height, finish or switch type on an item can be done upon request.

**VARIATION**

Minor variations may occur in product dimensions and finishes due to the handmade nature of our products. We recommend that designs being purchased in pairs or sets for a specific job be ordered together to ensure they match.





A black, hourglass-shaped vase containing a bouquet of white lilies with green stems and leaves.

A small, dark, shallow bowl with a slightly irregular, organic shape.

A stack of three books. The top book has a white cover with a black spine and the word "HORSE" visible. The middle book has a dark cover. The bottom book has a white cover with the title "Women in the Mirror" and the author "Richard Avedon" visible.

A white, square tray with a grid pattern, used for holding small objects.

A modern table lamp with a black metal frame and a white, cylindrical shade. The lamp is positioned on the right side of the table.

A white ceramic stool with two large, oval-shaped cutouts on the sides. It has a decorative band around the top and bottom edges.

**PRODUCT INDEX**

Product	Page	Product	Page	Product	Page	Product	Page	Product	Page
81134	270	ARN1007	266	ARN5003	561	BBL3032	156	CHA8988	31
82034	832, 833	ARN1009	267	ARN5009	378	BBL3050	144	CHA8993	27, 169
91025	268, 269	ARN1010	263	ARN5011	438	BBL3060	144	CHA8994	30, 118
92025	834	ARN1014	264	ARN5033	450	BBL3070	145	CHA9106	233
92000D	827	ARN1022	189	ARN5034	450	BBL3110	143	CHA9107	278
AH2000	761	ARN1025	242	ARN5052	373	BBL4065	956	CHA9121	259
AH2001	761	ARN2000	685	ARN5100	304, 305	BBL4066	956	CHA9124	258
AH2002	758, 759	ARN2001	684, 685	ARN5101	304	BBL5015	420	CHA9125	258
AH2003	758	ARN2002	812, 813	ARN5102	294, 295	BBL5016	421	CHA9161	276
AH2004	757	ARN2003	812	ARN5103	295	BBL5023	417	CHA9461	217
AH2010	757	ARN2004	732, 898	ARN5104	296	BBL5024	590, 591	CHA9707	205
AH2012	827	ARN2005	732, 898	ARN5105	283, 285, 286	BBL5025	418	CHA9710	209
AH2013	760	ARN2006	807	ARN5106	300, 301	BBL5030	424	CHA9715	209
AH2015	760	ARN2007	654	ARN5108	327	BBL5032	422	CHA9722	218
AH2016	671	ARN2010	872	ARN5110	326	BBL5033	422	CHC1120	406
AH2023	863	ARN2013	865	ARN5112	354, 355	BBL5035	492, 493	CHC1131	406
AH2030	665	ARN2018	752, 753	ARN5116	319	BBL5055	552	CHC1139	318
AH2031	665	ARN2018	884	ARN5120	286	BBL5058	552	CHC1140	318
AH2040	664	ARN2020	792	ARN5124	287	BBL5065	957	CHC1141	318
AH2200	906, 907	ARN2022	686	ARN5126	301	BBL5080	372	CHC1143	312
AH2201	904, 905	ARN2024	806, 807	ARN5148	290	BBL5081	372	CHC1144	312
AH2202	907	ARN2026	656	ARN5160	303	CHA3626	108	CHC1152	311
AH2203	904	ARN2034	794	ARN5161	303	CHA8141	121	CHC1154	310
AH2305	762	ARN2036	792, 793	ARN5170	298	CHA8150	182	CHC1155	311
AH2700	840	ARN2039	799	ARN5172	291	CHA8162	100	CHC1156	311
AH2701	839, 840	ARN2040	656	ARN5173	299	CHA8172	100	CHC1180	313
AH2702	840	ARN2043	799	ARN5200	570	CHA8173	100	CHC1403	400
AH2703	840	ARN2045	791	ARN5202	440	CHA8174	90	CHC1407	342
AH3024	136	ARN2051	687	ARN5203	440	CHA8175	90	CHC1408	340, 341
AH3028	183	ARN2052	687	ARN5210	549	CHA8180	99	CHC1413	394
AH3034	152	ARN2105	657	ARN5213	423	CHA8188	165	CHC1415	394
AH3040	114	ARN2124	657	ARN5220	302	CHA8192	182	CHC1420	335
AH3044	136, 137	ARN2148	657	ARN5221	302	CHA8254	138	CHC1426	342
AH3046	91	ARN2220	654	ARN5306	434	CHA8265	140, 141	CHC1432	401
AH3049	169	ARN2223	655	ARN5350	451	CHA8315	166	CHC1441	500
AH3050	29	ARN2226	655	ARN5351	451	CHA8359	98, 99	CHC1447	407
AH3063	76, 77	ARN3000	37, 104	ARN5352	451	CHA8370	123	CHC1448	407
AH3082	77	ARN3002	110	BBL1002	192, 193	CHA8463	131	CHC1462	409
AH3100	90	ARN3003	181	BBL1018	226	CHA8530	116, 117	CHC1463	409
AH3105	114, 115	ARN3004	80, 81	BBL1023	230	CHA8531	117	CHC1474	387
AH3110	79	ARN3006	179	BBL1025	227	CHA8539	149	CHC1477	549
AH3115	79	ARN3008	178	BBL2010	814, 815	CHA8590	48	CHC1480	428, 429
AH3125	78, 79	ARN3010	178	BBL2012	790	CHA8608	56, 57	CHC1481	502, 503
AH3127	78, 79	ARN3011	81	BBL2016	735	CHA8613	55	CHC1482	502, 503
AH3500	183	ARN3013	63, 81	BBL2017	738, 139	CHA8615	55	CHC1483	430
AH4000	609	ARN3015	111	BBL2020	884	CHA8617	56	CHC1494	400
AH4004	604	ARN3022	125	BBL2023	739	CHA8627	55, 101	CHC1497	496
AH4005	604	ARN3024	28, 82	BBL2025	736	CHA8628	55	CHC1498	496
AH4010	609	ARN3026	29, 82	BBL2027	816, 817	CHA8642	54, 112	CHC1501	332
AH4014	597, 600, 601	ARN3030	95	BBL2028	816	CHA8646	25, 83	CHC1508	341
AH4015	597, 601	ARN3032	110	BBL2029	818	CHA8651	27	CHC1520	335
AH4016	597, 606	ARN3036	82	BBL2030	736	CHA8653	42	CHC1521	334
AH4017	597, 606	ARN3070	109	BBL2030	737	CHA8655	46, 47	CHC1523	323
AH4018	596, 597	ARN3100	34, 105	BBL2035	724, 725	CHA8661	52, 53	CHC1525	315
AH4020	607	ARN3130	105	BBL2036	734, 735	CHA8663	52	CHC1526	314, 315
AH4021	603	ARN3150	109	BBL2038	726	CHA8666	50, 51	CHC1530	309
AH4025	607	ARN3600	103	BBL2039	726	CHA8695	112	CHC1534	307
AH4029	599	ARN3601	102, 103	BBL2060	956	CHA8695	113	CHC1535	308
AH4030	599	ARN3604	104	BBL2061	954	CHA8707	131	CHC1536	308
AH4035	602	ARN3606	58, 59	BBL2062	956	CHA8710	26, 168	CHC1543	345
AH4200	594	ARN3608	60, 61	BBL2063	954	CHA8728	49	CHC1547	322
AH4201	594	ARN3610	62, 63	BBL2070	954	CHA8906	30, 130	CHC1548	345
AH5000	441	ARN3614	64	BBL2072	954, 955	CHA8909	35	CHC1550	328, 329
AH5002	441	ARN3616	64, 65	BBL2080	686	CHA8917	24, 25	CHC1551	329
AH5010	358	ARN3620	67	BBL2090	879	CHA8924	25, 85	CHC1552	330
AH5025	392	ARN3622	66	BBL2094	879	CHA8926	26	CHC1554	344
AH5026	392, 393	ARN3623	66	BBL2105	879	CHA8931	85	CHC1555	333
AH5027	421	ARN4000	585	BBL2110	791	CHA8933	28	CHC1559	330
AH5210	432	ARN4001	584	BBL3003	109	CHA8934	28, 86	CHC1561	349
AH5215	433	ARN4002	584	BBL3006	44, 45	CHA8945	86	CHC1562	349
AH5216	433	ARN4004	581	BBL3008	142, 143	CHA8947	86	CHC1577	399
ARN1000	195	ARN4006	584	BBL3009	45	CHA8950	30	CHC1582	402
ARN1001	247	ARN4041	605	BBL3012	111	CHA8951	30	CHC1583	402
ARN1002	185, 187, 188	ARN4047	605	BBL3013	146, 147	CHA8960	86	CHC2107	522
ARN1003	240, 241	ARN4102	581	BBL3023	147	CHA8969	85, 132	CHC2108	522
ARN1004	280	ARN4120	581	BBL3024	154, 155	CHA8970	85, 132, 133	CHC2109	573
ARN1005	219	ARN5001	438, 439	BBL3025	154	CHA8974	84, 134	CHC2110	572
ARN1006	261, 262	ARN5002	560, 561	BBL3030	156	CHA8983	38, 39	CHC2111	564

PRODUCT INDEX

Product	Page	Product	Page	Product	Page	Product	Page	Product	Page
CHC2112	563	CHC4392	612	CHD2102	778, 779	CHO2152	928	KW5020	443
CHC2114	576	CHC5050	534	CHD2150	836	CHO2153	929	KW5021	443
CHC2117	573	CHC5055	468, 469	CHD2153	897	CHO2154	929	KW5022	442
CHC2118	575	CHC5058	469	CHD2154	825	CHO2155	929	KW5071	445
CHC2126	574	CHC5101	431	CHD2165	786, 787	CHO2156	928	KW5072	445
CHC2128	564	CHC5102	504	CHD2262	640	CHO2157	928	KW5074	444
CHC2135	562	CHC5130	306, 307	CHD2264	640	CHO2222	930	KW5075	444
CHC2136	562	CHC5132	459	CHD2266	722	CHO2224	930, 931	KW5077	445
CHC2138	333	CHC5133	458	CHD2300	698, 699	CHO2400	938	KW5091	292
CHC2149	440	CHC5136	546, 457	CHD2359	862, 863	CHO2401	938	KW5095	292
CHC2155	525	CHC5201	538	CHD2460	710, 711	CHO2500	938	KW5098	293
CHC2160	527	CHC5203	538	CHD2461	712	CHO2800	936	KW5200	380
CHC2161	521	CHC5211	537	CHD2462	903	CHO2802	937	KW5201	380, 381
CHC2164	510	CHC5212	537	CHD2463	903	CHO2803	937	KW5202	380
CHC2165	507, 510, 511	CHC5213	536, 537	CHD2464	903	CHO5003	945	KW5550	488
CHC2166	485	CHC5231	539	CHD2465	774	CHO5031	941	KW5553	489
CHC2167	553	CHC5232	539	CHD2466	774	CHO5032	941	MS2012	763
CHC2169	548	CHC5234	539	CHD2470	682, 683	CHO5033	941	MS2013	763
CHC2175	510	CHC5235	539	CHD2472	913	CHO5084	949	MS2015	773
CHC2176	509	CHC5370	387	CHD2473	912	CHO5085	949	MS2020	763
CHC2177	508	CHC5373	386, 387	CHD2474	913	CHO5802	937	MS2021	763
CHC2180	520	CHC5374	403	CHD2540	722	CHO7031	942	MS3002	96, 97
CHC2181	520	CHC5380	345	CHD2550	647	CHO7032	942	MS5020	359
CHC2182	520	CHC5470	403	CHD2551	646, 647	CHO7033	942	MS5025	359
CHC2186	546, 547	CHC5472	479	CHD2705	700	CHO7110	945	MS5030	565
CHC2190	521	CHC5473	478	CHD2712	641	CHO7111	945	NW1011	194
CHC2201	466	CHC5474	479	CHD2713	641	CHO7113	949	NW2005	649
CHC2202	466	CHD1122	777	CHD2908	780, 952, 953	CHO7802	937	NW2011	677
CHC2209	571	CHD1125	692	CHD2910	780, 781, 852	CL1002	208	NW2030	648
CHC2210	571	CHD1126	692	CHD2930	951	CL2002	789	NW2051	648
CHC2212	572	CHD1138	776	CHD2933	950	CL2016	795	NW2110	676
CHC2215	532	CHD1139	776	CHD2935	951	CL2170	837	NW2115	676
CHC2215	533	CHD1154	642, 643	CHD2936	951	CL2172	788	NW2220	675
CHC2216	532	CHD1155	643	CHD2950	932, 933	CL2181	788	NW2226	675
CHC2217	528	CHD1156	643	CHD2952	933	KW1060	281	NW2311	677
CHC2251	517	CHD1158	689	CHD2957	641	KW1088	265	NW3001	43
CHC2270	567	CHD1161	775	CHD2970	720, 721	KW2010	800	NW3011	122
CHC2366	527	CHD1172	679	CHD4174	681	KW2043	880	NW4001	580
CHC2461	350	CHD1174	679	CHD4175	680, 681	KW2044	880	NW4007	580
CHC2462	351	CHD1175	772	CHD4178	681	KW2047	881	NW4015	582
CHC2463	350	CHD1183	678	CHD5101	825	KW2048	881	NW4051	580
CHC2465	352, 353	CHD1184	678	CHD5102	828	KW2050	882, 883	NW5005	337
CHC2530	558	CHD1185	672	CHD5106	819	KW2057	883	NW5006	336, 337
CHC2531	558, 559	CHD1186	672	CHD5117	845	KW2060	796	NW5011	411
CHC2535	545	CHD1190	723	CHD5137	845	KW2063	796	NW5015	338
CHC2536	545	CHD1191	723	CHD5147	844, 845	KW2070	794	NW5016	338, 339
CHC3108	523	CHD1388	696	CHD5148	845	KW2090	801	NW5025	554, 555
CHC3109	523	CHD1404	695	CHO2031	939	KW2091	800	NW5026	555
CHC3413	524	CHD1407	695	CHO2032	939	KW2092	800	NW5030	331
CHC3414	524	CHD1495	688	CHO2033	940	KW2112	797	NW5031	331
CHC3420	515	CHD1496	688	CHO2034	939	KW2113	797	NW5040	357
CHC3421	515	CHD1508	639	CHO2035	939	KW2115	797	NW5041	356, 357
CHC3422	515	CHD1515	901	CHO2036	940	KW2200	659	NW5051	297
CHC3423	516	CHD1516	901	CHO2038	940	KW2201	659	NW5100	544
CHC3425	515	CHD1517	901	CHO2040	946	KW2202	659	PT2000	819
CHC3426	517	CHD1525	639	CHO2041	946	KW2204	658	S1010	257
CHC3427	516	CHD1531	899	CHO2042	946	KW3010	92	S1012	257
CHC3428	516	CHD1532	899	CHO2043	948	KW3021	70	S1026	256
CHC3436	524	CHD1550	859	CHO2044	948	KW3024	70, 71	S1050	210
CHC3438	513	CHD1551	859	CHO2060	926	KW3025	69	S1052	211
CHC3439	513	CHD1552	859	CHO2061	927	KW3032	68	S1087	248
CHC3440	512	CHD1553	858	CHO2062	926	KW3034	70	S1100	277
CHC3441	514	CHD1555	651	CHO2063	927	KW3036	70	S1111	254
CHC3444	546	CHD1560	860	CHO2064	923, 925, 927	KW3042	67	S1200	259
CHC4125	630	CHD1561	860	CHO2065	926	KW3046	69	S1400	212, 213
CHC4126	630	CHD1562	861	CHO2066	926	KW3055	151	S1404	208
CHC4128	629	CHD1563	861	CHO2067	927	KW3060	151	S20	733
CHC4129	628, 629	CHD1601	662	CHO2084	946	KW3085	150, 151	S2000	824
CHC4132	625	CHD1602	662	CHO2085	947	KW3088	92	S2001	769
CHC4140	631	CHD1610	719	CHO2086	948	KW3091	92, 93	S2003	893
CHC4201	619	CHD1612	719	CHO2087	948	KW4012	592	S2005	772
CHC4202	619	CHD1625	691	CHO2109	943	KW4013	592	S2006	893
CHC4203	619	CHD1627	691	CHO2110	943	KW4050	593	S2010	829
CHC4206	583	CHD2000	779	CHO2111	943	KW4060	593	S2015	783
CHC4207	583	CHD2050	873	CHO2112	944	KW4061	593	S2017	782, 783
CHC4215	626	CHD2051	663, 889	CHO2113	943	KW4070	588	S2020	714, 715
CHC4215	626	CHD2055	873	CHO2150	928	KW4071	588	S2021	715
CHC4391	612	CHD2056	663	CHO2151	929	KW5012	293	S2022	920

**PRODUCT INDEX**

Product	Page	Product	Page	Product	Page	Product	Page	Product	Page
S2024	921	SE4100	586	SL2703	843	SP1505	235	TOB2002	742, 743
S2025	921	SK1004	243	SL2704	842	SP1508	271	TOB2003	870
S2026	921	SK1008	222	SL2705	842	SP2000	777	TOB2004	871
S2030	705	SK1200	198	SL2706	842	SP2003	674	TOB2005	870
S2050	704	SK1500	196, 197	SL2707	842	SP2013	644	TOB2006	872
S2052	704	SK1505	199	SL2708	843	SP2020	644	TOB2007	744
S2090	706	SK1610	225	SL2800	830, 831	SP2022	746	TOB2008	744, 745
S2101	775	SK2000	702	SL2813	768	SP2025	644, 645	TOB2009	744
S2107	694	SK2002	673	SL2814	768	SP2070	934	TOB2010	750
S2108	694	SK2008	651	SL2815	769	SP2071	934	TOB2011	751
S2110	771, 781	SK2009	696	SL2816	769	SP2075	934	TOB2011	892
S2112	771	SK2016	633, 635, 636	SL2817	830	SP2076	934	TOB2015	885
S2120	693	SK2050	668, 669	SL2819	731	SP2077	934	TOB2016	856
S2121	693	SK2052	668	SL2820	730, 731	SP2504	746	TOB2017	752
S2150	888	SK2060	671	SL2841	890	SP2701	849	TOB2019	846
S2155	888	SK2105	689	SL2842	890	SP2701	849	TOB2020	846
S2210	770	SK2109	826	SL2843	890	SP2702	849	TOB2021	846
S2212	770	SK2115	810, 811	SL2845	755	SP2704	848	TOB2022	885
S2320	660	SK2250	718	SL2845	755	SP2706	849	TOB2023	847
S2401	700	SK2251	718	SL2846	755	SP3005	96	TOB2030	855
S2406	701	SK2258	694	SL2860	716	SP3011	164	TOB2031	854, 855
S2408	701	SK2263	697	SL2861	716	SP3015	45	TOB2032	638
S2500	826	SK2301	784, 785	SL2865	717	SP3022	166	TOB2033	637, 638
S2601	805	SK2501	697	SL2866	717	SP5001	518, 519	TOB2036	751
S2602	805	SK3005	165	SL2920	829	SP5002	518	TOB2050	895
S2650	837	SK3008	169	SL2920	835	SP5003	518	TOB2051	895
S3030	180	SK3100	129	SL2922	803, 804	SP5004	529	TOB2062	856, 857
S3045	120, 121	SK3115	181	SL2923	804	SP5071	935	TOB2067	748, 749
S3051	126	SK3207	135	SL2931	910, 911	SP5072	935	TOB2068	749
S3052	127	SK3208	135	SL2932	910	SP7071	935	TOB2070	756
S3054	127	SK3500	128	SL2932	910, 911	SP7072	935	TOB2081	750
S3085	140	SK3549	128	SL2933	910, 911	SR1201	201	TOB2082	620
S3090	139	SK3610	167	SL2934	908	SR2000	708	TOB2105	878
S3091	139	SK3900	35	SL2935	908, 909	SR2006	660, 661	TOB2110	767
S3400	124	SK3901	35	SL2941	900	SR2011	795	TOB2120	766
S3401	124	SK3902	27	SL2942	900	SR2013	670	TOB2121	766
S3407	125	SK3905	21, 23	SL2943	900	SR2140	708	TOB2125	740
S3701	27	SK3918	33	SL2975	836, 896, 897	SR5002	568	TOB2126	740, 741
S5010	467	SK4000	587, 690	SL3025	175	SR5005	525	TOB2128	728
S5012	467	SK4008	631	SL3032	182	SR5017	384	TOB2131	728, 729
S5015	486, 487	SK4010	595	SL3334	25	SR5020	383	TOB2135	764
S5022	375	SK4011	595	SL3338	26, 99	SR5021	382	TOB2137	764
S5024	376	SK5000	391	SL3339	26, 99	SR5101	568, 569	TOB2140	853
S5030	415, 416	SK5001	390	SL3811	42	SR5110	289	TOB2141	853
S5031	416	SK5002	391	SL3845	42	SR5111	288, 289	TOB2152	886
S5032	416	SK5003	388	SL4001	618	SR5140	385	TOB2153	886
S5033	416	SK5004	389	SL4002	618	SR5141	385	TOB2154	887
S5040	374	SK5007	535	SL4120	625	SR5144	343	TOB2156	808, 809
S5041	374	SK5008	541, 542, 543	SL5001	624	SS2001	902	TOB2170	756
S5045	550, 551	SK5009	541, 542, 543	SL5125	462, 463	SS2002	902	TOB2184	852
S5046	550	SK5010	540 - 543	SL5174	461	SS2003	902	TOB2185	851, 852
S5047	435	SK5012	399	SL5175	460	SS2011	869	TOB2186	894
S5048	435	SK5016	413	SL5811	501	SS2013	869	TOB2187	894
S5100	410	SK5019	413	SL5812	408	SS2014	868	TOB2190	754
S5211	395	SK5022	398	SL5813	408	SS2031	727	TOB2191	754
S5212	395	SK5095	389	SL5814	408	SS4010	598	TOB2197	866
S5270	377	SK5100	332	SL5816	494, 495	SS4011	598	TOB2198	866
S5271	377	SK5102	410	SL5818	427	SS4015	610, 611	TOB2201	820
S5315	412	SK5200	589	SL5820	425	SS4016	611	TOB2202	821
S5316	498, 499	SK5201	589	SL5863	497	TOB1000	220	TOB2203	821
S5395	379	SK5202	589	SL5870	531	TOB1001	274	TOB2204	822, 823
SC1101	249	SK5300	535	SL5871	531	TOB1002	228, 229	TOB2206	867
SC1104	190	SK5301	535	SL5872	530, 531	TOB1004	221	TOB2207	867
SC1105	190, 191	SK5513	526	SLO2001	958	TOB1010	244, 245	TOB2208	876, 877
SC2105	709	SK5536	437	SLO2003	959	TOB1012	237	TOB2209	876
SC2106	762	SK5537	436	SLO4000	958	TOB1013	236	TOB2210	874
SC2160	709	SK5538	437	SLO4002	958	TOB1015	275	TOB2212	875
SC2200	706	SK5540	566	SN2107	650	TOB1021	239	TOB2213	875
SC2200	707	SL1031	279	SN4001	579	TOB1027	252, 253	TOB2217	703
SC4000	586	SL1126	255	SN5107	320, 321	TOB1147	223	TOB2220	703
SC5001	361	SL1700	250, 251	SN5108	321	TOB1151	216	TOB2221	666, 667
SC5002	361	SL1900	276	SP1000	206, 207	TOB1152	204	TOB2225	915 - 919
SC5005	346	SL2000	874	SP1002	203	TOB1153	246	TOB2226	914 - 919
SC5005	347	SL2151	891	SP1003	200	TOB1155	214, 215	TOB2235	652
SC5015	346	SL2152	891	SP1004	202	TOB1200	272, 273	TOB2236	652
SC5102	360	SL2153	891	SP1008	224	TOB1201	231	TOB2237	653
SC5159	557	SL2701	843	SP1022	232	TOB1720	238	TOB2261	892
SC5160	556, 557	SL2702	843	SP1504	234	TOB2000	841	TOB2264	864

PRODUCT INDEX

NOTES

Product	Page	Product	Page
TOB2265	864	TOB4162	613
TOB2327	765	TOB4203	614
TOB2328	765	TOB4206	614
TOB2330	664	TOB4212	577
TOB2335	773	TOB4215	615
TOB2380	727	TOB4216	615
TOB2470	652	TOB4220	627
TOB2471	652	TOB4221	592
TOB2600	713	TOB4261	623
TOB2604	841	TOB4264	623
TOB2605	841	TOB5000	452
TOB2606	841	TOB5002	368
TOB2711	798	TOB5003	368, 369
TOB2730	666	TOB5004	490, 491
TOB2740	747	TOB5005	491
TOB2741	747	TOB5007	367
TOB2753	682	TOB5008	366, 367
TOB3000	153	TOB5009	365
TOB3001	153	TOB5010	365
TOB3004	162, 163	TOB5011	419
TOB3007	158, 159	TOB5012	452
TOB3011	87	TOB5013	452
TOB3014	36	TOB5014	446, 447
TOB3020	88	TOB5015	371
TOB3023	36, 88	TOB5016	371
TOB3026	118, 119	TOB5017	362
TOB3027	40	TOB5018	363
TOB3029	41	TOB5019	364
TOB3030	39	TOB5030	576
TOB3031	39	TOB5031	316
TOB3032	148	TOB5032	316
TOB3033	148	TOB5033	317
TOB3051	36, 152	TOB5036	324, 325
TOB3077	87	TOB5042	453
TOB3094	32, 88	TOB5043	453
TOB3095	32, 88	TOB5045	370
TOB3095	89	TOB5046	370
TOB3096	32	TOB5055	470
TOB3129	41	TOB5062	471, 473
TOB3142	174	TOB5063	473
TOB3152	122	TOB5064	472
TOB3180	163	TOB5089	449
TOB3190	171, 172, 173	TOB5090	449
TOB3193	160	TOB5091	448
TOB3194	160, 161	TOB5105	553
TOB3195	94, 95	TOB5109	405
TOB3197	174	TOB5111	404, 405
TOB3206	177	TOB5119	404
TOB3209	134	TOB5135	426
TOB3222	157	TOB5143	480
TOB3235	87	TOB5144	480
TOB3362	91	TOB5150	481, 622
TOB3378	36	TOB5154	464
TOB3386	74	TOB5155	464
TOB3387	74, 75	TOB5156	465
TOB3408	159	TOB5157	465
TOB3536	175	TOB5159	483
TOB3650	176	TOB5160	482, 483
TOB3709	35	TOB5205	396
TOB3710	72	TOB5206	396, 397
TOB3720	157	TOB5226	474 - 477
TOB3725	177	TOB5261	454, 455
TOB3734	106	TOB5262	454
TOB3735	106, 107	TOB5470	326
TOB3755	33		
TOB3757	33		
TOB3780	72		
TOB3804	73		
TOB3807	73		
TOB4000	621		
TOB4003	626		
TOB4006	621		
TOB4011	616, 617		
TOB4013	617		
TOB4084	620		
TOB4130	608		
TOB4131	608		
TOB4161	613		





**VISUAL COMFORT & CO.**

22008 NORTH BERWICK DRIVE

HOUSTON, TX 77095

713.686.5999