

P&C

**made
in Italy**

Pacini  Cappellini

Pacini  Cappellini

index

indice prodotti

tables

fashion pag .10 .11
nature pag .12 .15
strike pag .16 .19
delta pag .20 .21
novecento pag .22 .23
plurimo pag .24 .33
modern pag .34 .35
cult pag .36 .37
elegance pag .38 .39
artù pag .40 .41
naxos pag .42 .43
omega pag .44 .45
dandy pag .46 .47
mony pag .48 .49
ellys pag .50 .51

console-tables & consoles

extra pag .54 .55
voilà pag .56 .57
long pag .58 .59
xelle pag .60 .61
millerighe pag .62 .63
kendo pag .64 .65

chairs & armchairs

betty pag .68 .69
lady pag .70 .71
greta pag .72 .73
elite pag .74 .75
dafne pag .74 .75
ciak pag .76 .77
relax pag .78 .79
kandy pag .80 .81
puffo pag .82 .83

bookcases

maze pag .86 .87
tree pag .88 .89
tres pag .90 .91
babele pag .92 .93
reflex pag .94 .95

tv stands

ghost pag .98 .99
luna pag .100 .101
totem pag .102 .103
screen pag .104 .107
cast pag .108 .109
sistema miki pag .110 .111
krea pag .112 .115
basic pag .116 .119

cupboards

line pag .122 .123
sistema maddy pag .124 .125
sistema maddy 2 pag .126 .127
tiffany pag .128 .131

desks

athos pag .134 .135
athena pag .136 .137

coffee tables

master pag .140 .141
corallo pag .142 .143
regal pag .144 .145
atollo pag .146 .147
scacco pag .148 .149
mosaico pag .150 .151
banner pag .152 .153
vogue pag .154 .155
pocket pag .156 .157
millerighe pag .158 .159
rebus pag .160 .161
plano pag .162 .163
prisma pag .164 .165
city pag .166 .167
zen pag .168 .171
duna pag .172 .173
ambo pag .174 .175
one pag .176 .177
fly pag .178 .179
cin-cin pag .180 .181
isola pag .182 .183
gong pag .184 .185
drink pag .186 .187

accessories

futura pag .190 .191
welcome pag .192 .193
l'albero pag .194 .195
tower pag .196 .197
vanity pag .198 .199
oblò pag .200 .201
regolo pag .200 .201
gallery pag .202 .203
kiara pag .202 .203
moon pag .204 .205
olimpo pag .206 .207
gossip pag .206 .207
fish pag .208 .209
margherita pag .210 .211
binario pag .212 .213
dado pag .214 .215
box 1 pag .216 .217
box 2 pag .216 .217



profilo aziendale

La storia di Pacini & Cappellini nasce da tanti amori: il legno, la casa, l'abitare inteso come aspetto della quotidianità essenziale per il benessere delle persone. Partendo da queste basi, da più di trent'anni, l'azienda produce e distribuisce in tutto il mondo mobili e complementi d'arredo per la casa e la collettività: tavoli, sedie e poltrone, librerie e consolle, ma anche madie e porta-tv realizzati interamente in Italia.

L'avventura di Alberto Pacini e Camillo Cappellini inizia quando capiscono che c'è soltanto un modo per dare concretezza alle loro passioni: realizzare mobili. Non oggetti qualsiasi, ma elementi speciali in grado di arricchire e ren-

dere unica la vita di ogni individuo. Forti di questa convinzione, i due soci scelgono di trasformarla in una vera missione, dando vita nel 1982 ad un progetto imprenditoriale basato sulla lavorazione artigianale di uno dei materiali più antichi, pregiati e funzionali: il legno. Così a Cabiato, in provincia di Como, nasce Pacini & Cappellini, che si afferma immediatamente come una delle realtà più solide del panorama italiano dell'arredamento.

La voglia di guardare al futuro, insieme alla volontà di assicurare continuità all'azienda, si realizza negli anni Novanta con l'ingresso dei figli Luigi, Roberto, Moreno e Giorgio. L'idea alla base della nuova guida è mante-

nere ben saldi i valori tradizionali - facendo proprie la creatività, la passione e lo spirito di ricerca dei padri - e introducendo sostanziali novità. Da una produzione prettamente classica, improntata su lavorazioni complesse di ebanisteria e intaglio, la nuova squadra si avvia verso un nuovo progetto industriale, che permetterà un decisivo cambio di scala e il passaggio al design. Per riuscire nell'impresa, Pacini & Cappellini si avvale di tecnologie e processi industriali nuovi e del contributo prezioso di un team di designer che darà vita a prodotti diventati icone, come i porta-tv disegnati da Fabio Rebosio per la collezione Screen o il tavolo Plurimo realizzato da Hanno Giesler.

company profile

The history of Pacini & Cappellini was born between many loves: wood, home, living thought as essential everyday life for the wellness of the people. Starting from those concepts, in the past 30 years, the Company manufactures and sells worldwide furniture and accessories for residential environment and communities: dining tables, chairs and armchairs, bookcases and consoles but also cupboards and wall systems with TV-stands, entirely manufactured in Italy.

The adventure of Alberto Pacini and Camillo Cappellini starts when they understand that there is just one way to make their passion coming real: manufacturing furniture. Not

common objects but special elements able to enrich and make unique the life of everyone. Being sure of that, the two partners decided to play this mission establish in 1982 a real business project based on the artisan workmanship of one of the most antique, precious and functional materials we have in nature: wood. So that in Cabiato, in the Como area, has been established Pacini & Cappellini, which became straight away one of the most solid business reality of the Italian furniture field.

The will of looking to the future, together with the will of securing the future of the Company, became real in the nineties when the sons of the founder Luigi, Roberto, Moreno and Giorgio

entered in the business. The idea is to keep firm the traditional values, learning from the fathers the creativity and passion and spirit of research, introducing substantial news. From a classical collection, based on complex inlay typical of the cabinetmaking art, the new team is developing a business plan, oriented to the contemporary design. To be successful in this intent Pacini & Cappellini is using technologies and new industrial processes, as well as the cooperation with a team of designer, developing products becoming icons like TV-stands designed by Fabio Rebosio for the Screen Collection and the Plurimo Table designed by Hanno Giesler.



P&C collezione Made in Italy

P&C

Made in Italy non è solo il consueto modo di dire per confermare le origini e il valore di un oggetto pensato, sviluppato e prodotto interamente in Italia, ma per noi vuole essere una dichiarazione di intenti, un attestato di qualità, tanto da volerlo trasformare nel nome di una collezione.

Made in Italy è un progetto/pensiero dai forti valori formali, una raccolta di elementi e complementi dal design contemporaneo, realiz-

zati con cura e con quel gusto della materia e della scelta dei legni squisitamente e tipicamente italiano: il frutto della collaborazione di un gruppo eterogeneo di affermati designer, dalla grande esperienza nel settore.

Ogni singolo pezzo è una storia a sé. La collezione è così una serie di piccole "storie" raccontate, dunque, in un luogo - il catalogo - dove sono raccolte idee e progetti con lo stesso

comune denominatore: la caratterizzazione di uno spazio e l'ottimizzazione di un servizio. Made in Italy, in definitiva, è una collezione che racconta di una continua dialettica tra forma e funzione, tra materiali e piacere d'uso, il cui obiettivo è il consolidamento e l'affermazione definitiva del marchio Pacini & Cappellini nel mondo dell'arredamento. Dal 1982.

P&C Made in Italy collection

Made in Italy is not just the usual way to indicate the origin and the value of a designed object, developed and manufactured entirely in Italy, but for us it is a statement of intent, a certificate of quality, so much that we decided to turn this phrase in the name of a collection.

Made in Italy is a project/thought by strong formal values, a collection of items and accessories with a

contemporary design, made with care and with the savoir of the material and the choice of woods typically and purely Italian: the result of the collaboration with a mixed group of skilled designers, from the great experience in that field. Each piece has its own story. The collection is as well a series of small "tales" told, thus, in one place - the catalogue - where ideas and projects, having the same

common denominator, have been collected: characterized space and optimized service. Made in Italy, ultimately, is a collection that tells of a continuous dialectic between form and function, materials and pleasure of use, whose aim is the consolidation and definitive statement of the brand Pacini & Cappellini in the furniture world. Since 1982.

TABLES

tavoli

fashion
nature
strike
delta
novecento
plurimo
modern
cult
elegance
artù
naxos
omega
dandy
mony
ellys



design Norberto Delfinetti e Monica Bernasconi

fashion

Tavolo da pranzo fisso o allungabile con struttura in massello e piano placcato frassino. Nella versione allungabile, meccanismo telescopico in alluminio con prolunghe interne placcate frassino. Finiture disponibili: WG wengé, NC noce, TB tabacco, Laccato opaco poro aperto.

Fixed or extendible dining table with structure in solid ash and top veneered ash. The extendible version has aluminium telescopic mechanism with inner extensions veneered ash. Available finishings: WG wengé, NC walnut, TB tobacco, Open pore matt lacquered.

table
cod.5416



fisso / fix

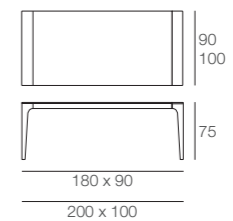

allungabile / extendible

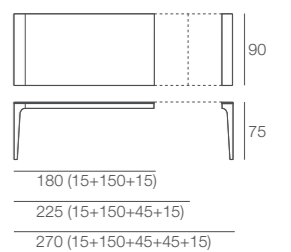



arch. Fabio Rebosio

nature

Tavolo da pranzo
allungabile con struttura
e piani placcati frassino.

Prolunghe laterali
alloggiate nel vano sotto
il piano. Meccanismo di
apertura in alluminio.

Finiture disponibili:
WG wengé, NC noce,
TB tabacco, Laccato
opaco poro aperto,
Decapato.

Extendible dining
table with structure
and tops veneered in
ash. Side extensions
housed under the top.

Aluminium opening
mechanism. Available
finishings: WG
wengé, NC walnut,
TB tobacco, Open
pore matt lacquered,
Decapé.

table
cod.5395



168/188 (12+144/164+12)
213/233 (12+144/164+45+12)
258/278 (12+144/164+45+45+12)

arch. Fabio Rebosio

nature

table
cod.5395





arch. Fabio Rebosio

strike

Tavolo da pranzo
fisso o allungabile con
struttura e piani placcati
frassino. Nella versione
allungabile, meccanismo
telescopico in alluminio
con prolunghe laterali
alloggiate nel vano
sotto il piano. Finiture
disponibili: WG wengé,
NC noce, TB tabacco,
Laccato opaco poro
aperto, Decapato.

Fixed or extendible
dining table with struc-
ture and tops veneered
in ash. The extendible
version has aluminium
telescopic mechanism
with side extensions
housed under the top.
Available finishings:
WG wengé, NC walnut,
TB tobacco, Open
pore matt lacquered,
Decapé.

table
cod.5413



fisso / fix

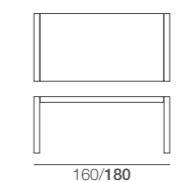

160/180

allungabile / extendible

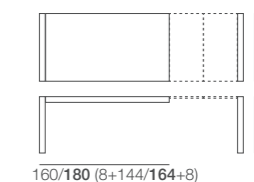

160/180 (8+144/164+8)

205/225 (8+144/164+45+8)

250/270 (8+144/164+45+45+8)

arch. Fabio Rebosio

strike

table
cod.5413





Studio Tecnico Pacini&Cappellini

delta

Tavolo da pranzo
allungabile con struttura
in massello di frassino.
Piano e prolunghe
laterali placcate frassino.
Meccanismo di apertura
in alluminio. Finiture
disponibili: WG wengé,
NC noce, TB tabacco.
Laccato opaco
poro aperto.

Extendible dining
table with structure in
solid ash. Top and side
extensions veneered
in ash. Aluminium
opening mechanism.
Available finishings:
WG wengé, NC walnut,
TB tobacco, Open pore
matt lacquered.

table
cod.5414

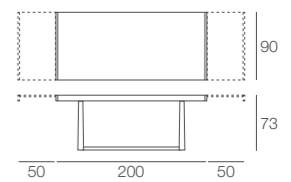



arch. Fabio Rebosio

novecento

Tavolo da pranzo con gambe in massello di frassino. Piano in legno placcato frassino o in vetro naturale temperato. Finiture disponibili: FN frassino naturale, CL ciliegio americano, WG wengé, NC noce, TB tabacco, Laccato opaco poro aperto, Decapato.

Dining table with structure in solid ash. Top veneered ash or in tempered clear glass. Available finishings: FN natural ash, CL american cherry, WG wengé, NC walnut, TB tobacco, Open pore matt lacquered, Decapé.

table
cod.5408

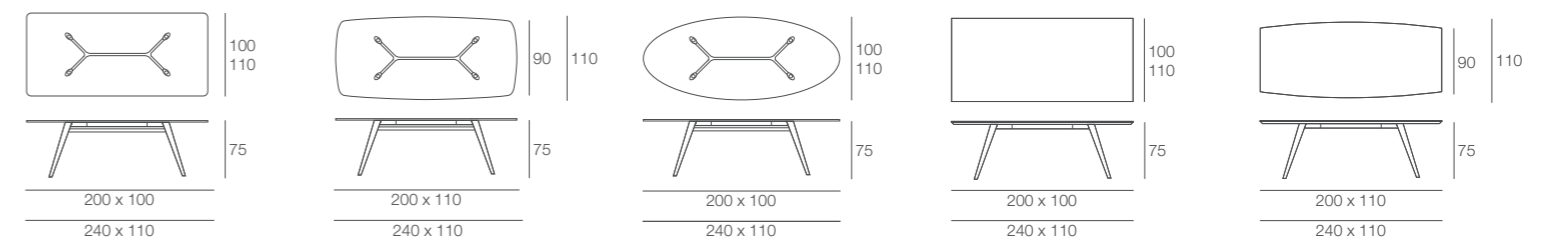



C

design Hanno Giesler

plurimo

table
cod.5482

Tavolo da pranzo quadrato allungabile su due lati, in larghezza ed in profondità con prolunghe alloggiare all'interno. Struttura in massello di frassino. Piano in legno placcato frassino. Prolunghe interne placcate. Meccanismo di apertura in alluminio. Modello brevettato e depositato. Finiture disponibili: CL ciliegio americano, WG wengé, NC noce, TB tabacco, Laccato opaco poro aperto, Decapato.

Square table, extendible both in width and length, with extensions hidden inside. Structure in solid ash. Ash veneered top. Inner extensions veneered. Aluminium opening mechanism. Patented and registered model. Available finishings: CL american cherry, WG wengé, NC walnut, TB tobacco, Open pore matt lacquered, Decapé.

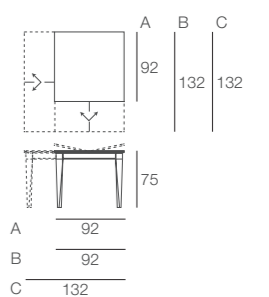
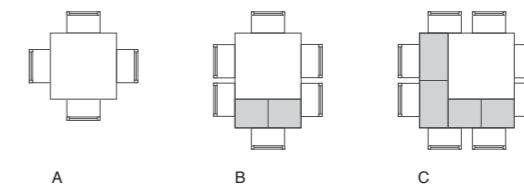



A

design Hanno Giesler

plurimo

table
cod.5483

Tavolo da pranzo quadrato maxi allungabile su due lati, in larghezza ed in profondità con prolunghe alloggiare all'interno. Struttura in massello di frassino. Piano in legno placcato frassino o in Cimento®. Prolunghe interne placcate. Meccanismo di apertura in alluminio. Modello brevettato e depositato. Finiture disponibili: CL ciliegio americano, WG wengé, NC noce, TB tabacco, Laccato opaco poro aperto, Decapato.

Maxi square table, extendible both in width and length, with extensions hidden inside. Structure in solid ash. Ash veneered top or Cimento®. Inner extensions veneered. Aluminium opening mechanism. Patented and registered model. Available finishings: CL american cherry, WG wengé, NC walnut, TB tobacco, Open pore matt lacquered, Decapé.



B



C

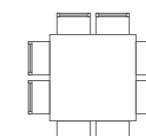

A

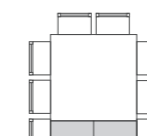

B

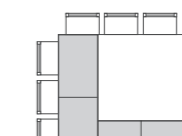

C

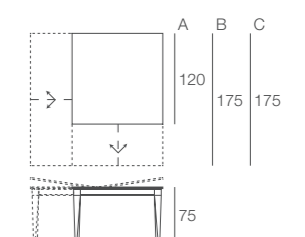

A	120
B	120
C	175

design Hanno Giesler

plurimo

table
cod.5483





A

design Hanno Giesler

plurimo

table
cod.5481
cod.5484

Tavolo da pranzo rettangolare e rettangolare maxi allungabile su due lati, in larghezza ed in profondità con prolunghe alloggiare all'interno. Struttura in massello di frassino. Piano in legno placcato frassino. Prolunghe interne placcate. Meccanismo di apertura in alluminio. Modello brevettato e depositato. Finiture disponibili: CL ciliegio americano, WG wengé, NC noce, TB tabacco, Laccato opaco poro aperto, Decapé.

Rectangular and maxi rectangular table, extendible both in width and length, with extensions hidden inside. Structure in solid ash. Ash veneered top. Inner extensions veneered. Aluminium opening mechanism. Patented and registered model. Available finishings: CL american cherry, WG wengé, NC walnut, TB tobacco, Open pore matt lacquered, Decapé.



B



C

5481

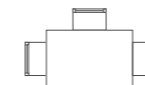

A

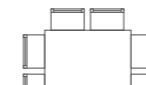

B



C

5484

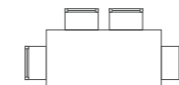

A

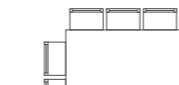

B

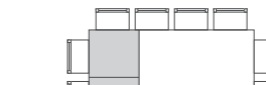

C

5481

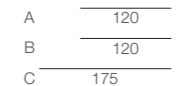
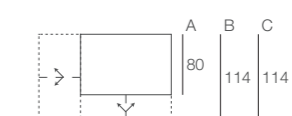

A
B
C

5484

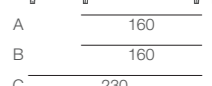
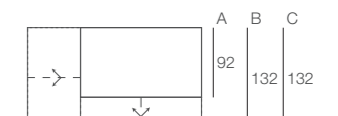

A
B
C



design Hanno Giesler

plurimo

table
cod.5481
cod.5484

Tavolo da pranzo rettangolare e rettangolare maxi allungabile su due lati, in larghezza ed in profondità con prolunghe alloggiare all'interno. Struttura in massello di frassino. Piano in legno placcato frassino. Prolunghe interne placcate. Meccanismo di apertura in alluminio. Modello brevettato e depositato. Finiture disponibili: CL ciliegio americano, WG wengé, NC noce, TB tabacco, Laccato opaco poro aperto, Decapé.

Rectangular and maxi rectangular table, extendible both in width and length, with extensions hidden inside. Structure in solid ash. Ash veneered top. Inner extensions veneered. Aluminium opening mechanism. Patented and registered model. Available finishings: CL american cherry, WG wengé, NC walnut, TB tobacco, Open pore matt lacquered, Decapé.



B



A

5481

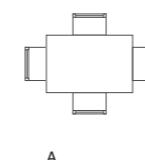

A

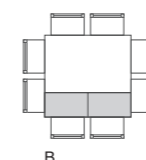

B

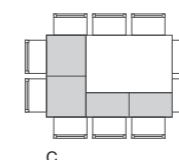

C

5484

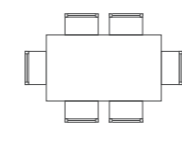

A

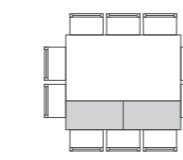

B

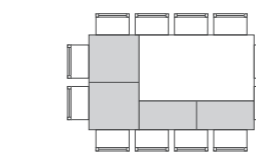

C

5481

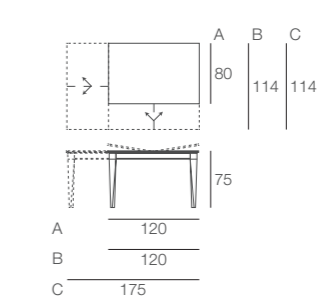

A

B

C

120

120

175

5484

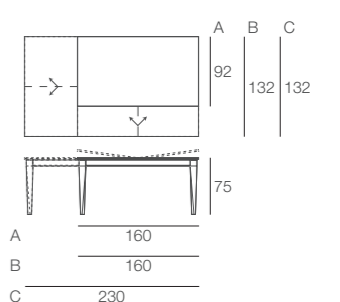

A

B

C

160

160

230

C



arch. Fabio Rebosio

modern

Tavolo da pranzo fisso o allungabile con struttura in massello di frassino. Piano in vetro verniciato o in legno placcato. Nella versione allungabile meccanismo di apertura in alluminio con prolunga interna placcata. Finiture disponibili: WG wengé, NC noce, TB tabacco, Laccato opaco poro aperto.

Fixed or extendible dining table with structure in solid ash. Top in lacquered glass or veneered. The extendible version has an aluminium opening mechanism with inner veneered extension. Available finishings: WG wengé, NC walnut, TB tobacco, Open pore matt lacquered.

table
cod.5417



fisso / fix

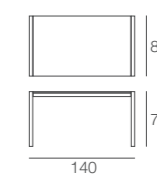

allungabile / extendible

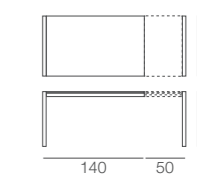



A

arch. Fabio Rebosio

cult

table
cod.5398

Tavolo da pranzo allungabile con struttura in massello di frassino. Piano e prolunghe placcati frassino. Meccanismo di apertura in alluminio. Finiture disponibili: WG wengé, NC noce, TB tabacco, Laccato opaco poro aperto.

Extendible dining table with structure in solid ash. Ash veneered top and extensions. Aluminium opening mechanism. Available finishings: WG wengé, NC walnut, TB tobacco, Open pore matt lacquered.



B



C

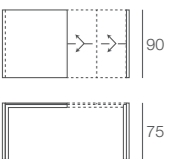

- A 90 (4+82+4)
- B 129 (4+82+39+4)
- C 168 (4+82+39+39+4)



arch. Fabio Rebosio

elegance

Tavolo da pranzo rotondo
allungabile con gambe in
massello di frassino. Piano
e prolunghe esterne plac-
cate frassino. Meccanismo
di apertura in alluminio.
Finiture disponibili:
WG wengé, NC noce,
TB tabacco, Laccato
opaco poro aperto.

Round extendible dining
table with legs in solid
ash. Ash veneered top
and outside extensions.
Aluminium opening
mechanism. Available
finishings: WG wengé,
NC walnut, TB tobacco,
Open pore matt
lacquered.

table
cod.5399

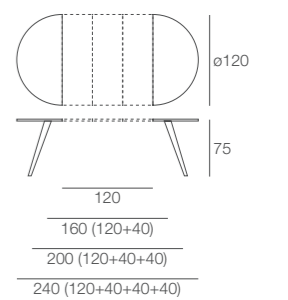



arch. Fabio Rebosio

artù

Tavolo da pranzo con struttura in massello di frassino. Piano in vetro naturale temperato. Finiture disponibili: FN frassino naturale, CL ciliegio americano, WG wengé, NC noce, TB tabacco, Laccato opaco poro aperto.

Dining table with structure in solid ash. Top in natural tempered glass. Available finishings: FN natural ash, CL american cherry, WG wengé, NC walnut, TB tobacco, Open pore matt lacquered.

table
cod.5406

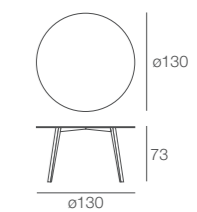



design Dario Perego

naxos

Tavolo da pranzo con struttura in massello di frassino e piano in vetro naturale temperato. Giunto centrale in metallo verniciato. Finiture disponibili: FN frassino naturale, WG wengé, NC noce, TB tabacco, Laccato opaco poro aperto.

Dining table with structure in solid ash, top in natural tempered glass. Central joint in painted metal. Available finishings: FN natural ash, WG wengé, NC walnut, TB tobacco, Open pore matt lacquered.

table
cod.5407

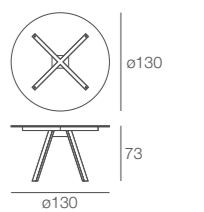



arch. Fabio Rebosio

omega

Tavolo da pranzo con struttura in massello di frassino. Piano allungabile in vetro naturale temperato. Meccanismo di apertura in alluminio brillantato o verniciato bianco. Finiture disponibili: FN frassino naturale, CL ciliegio americano, WG wengé, NC noce, TB tabacco, Laccato opaco poro aperto.

Dining table with structure in solid ash. Extendible top in natural tempered glass. Glossy aluminium or painted white opening mechanism. Available finishings: FN natural ash, CL american cherry, WG wengé, NC walnut, TB tobacco, Open pore matt lacquered.

table
cod.5405

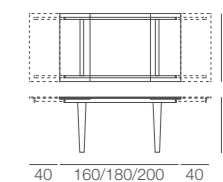



design Norberto Delfinetti e Monica Bernasconi

dandy

Tavolo da pranzo con
gambe in fibra di legno
o placcate frassino.
Piano in vetro naturale
temperato con piastre
elettrosaldate. Finiture
disponibili: WG wengé,
NC noce, TB tabacco,
Laccato opaco poro
chiuso, Laccato brillante.

Dining table with legs
in fiberboard or veneered
in ash. Top in natural
tempered glass with
electro welded supports.
Available finishings:
WG wengé, NC walnut,
TB tobacco, Closed
pore matt lacquered,
Glossy lacquered.

table
cod.5411

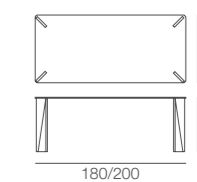



design Norberto Delfinetti e Monica Bernasconi

mony

Tavolo con struttura cromata e piano in vetro naturale temperato con piastre elettrosaldate.

Dining table with structure in chrome-plated metal and top in natural tempered glass with electro welded supports.

table
cod.5412

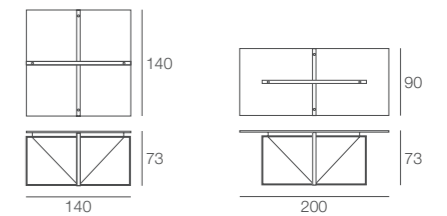



design Norberto Delfinetti e Monica Bernasconi

ellys

table
cod.5409

Tavolo da pranzo con piano ovale in fibra di legno o placcato frassino. Base centrale rivestita in acciaio supermirror lucido. Basamento in stratificato alluminio. Finiture disponibili: WG wengé, NC noce, TB tabacco, Laccato opaco poro chiuso, Laccato brillante.

Dining table with oval top in fiberboard or veneered in ash. Central support covered in polished supermirror steel. Base in stratified aluminium. Available finishings: WG wengé, NC walnut, TB tobacco, Closed pore matt lacquered, Glossy lacquered.

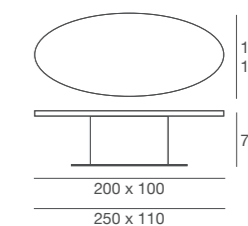

CONSOLE-TABLES & CONSOLES

tavoli-consolle e consolle

extra
voilà
long
xelle
millerighe
kendo



arch. Fabio Rebosio

extra

Tavolo-consolle allungabile con struttura in massello e piani placcati frassino. Dotato di 3 o 4 prolunghe per ottenere misure diverse. Meccanismo telescopico in alluminio. Finiture disponibili: WG wengé, NC noce, TB tabacco, Laccato opaco poro aperto.

Extendible console-table with structure in solid ash and ash veneered tops. Equipped with 3 or 4 extensions to change the size of the table. Telescopic aluminium mechanism. Available finishings: WG wengé, NC walnut, TB tobacco, Open pore matt lacquered.

console-table
cod. 5421
cod. 5421.2

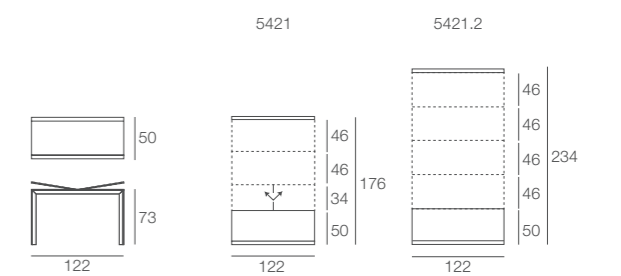



design Giuliano Cappelletti

voilà

Tavolo-consolle allungabile con struttura in massello e piani placcati frassino. Dotato di 3 o 5 prolunghe per ottenere misure diverse. Meccanismo telescopico in alluminio. Finiture disponibili: WG wengé, NC noce, TB tabacco, Laccato opaco poro aperto.

Extendible console-table with structure in solid ash and veneered tops. Equipped with 3 or 5 extensions to change the size of the table. Telescopic aluminium mechanism. Available finishings: WG wengé, NC walnut, TB tobacco, Open pore matt lacquered.

console-table
cod.5423
cod.5423.2

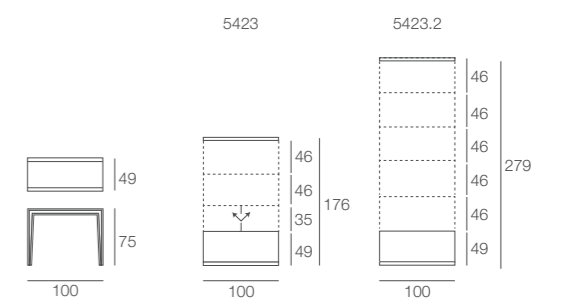



arch. Fabio Rebosio

long

Tavolo-consolle allungabile con struttura in massello e piani placcati frassino. Dotato di 4 o 5 prolunghe per ottenere misure diverse. Meccanismo telescopico in alluminio. Finiture disponibili: WG wengé, NC noce, TB tabacco, Laccato opaco poro aperto.

Extendible console-table with structure in solid ash and ash veneered tops. Equipped with 4 or 5 extensions to change the size of the table. Telescopic mechanism in aluminium. Available finishings: WG wengé, NC walnut, TB tobacco, Open pore matt lacquered.

console-table
cod.5426
cod.5426.2

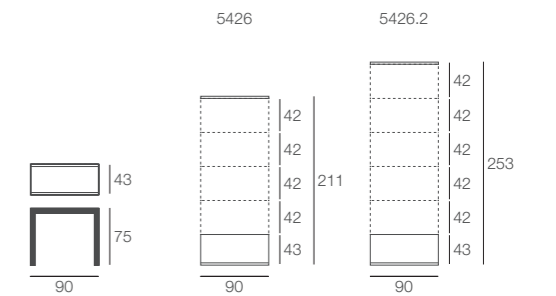



arch. Fabio Rebosio

xelle



Tavolo-consolle con struttura in materiale decorativo. Dotato di 5 prolunghe per ottenere misure diverse. Meccanismo telescopico in alluminio con snodo centrale. A richiesta elemento porta-prolunghe. Finiture disponibili: D materiale decorativo (BP bianco opaco poro aperto, BA bianco antico, OL olmo, WG wengé).

Console-table with structure in decorative material. Equipped with 5 extensions to change the size of the table. Telescopic mechanism in aluminium with central joint. On request, holder for extensions. Available finishings: D decorative material (BP open pore matt white, BA antique white, OL elm, WG wengé).

console-table
cod. 5425
holder for extensions
cod. 5425C

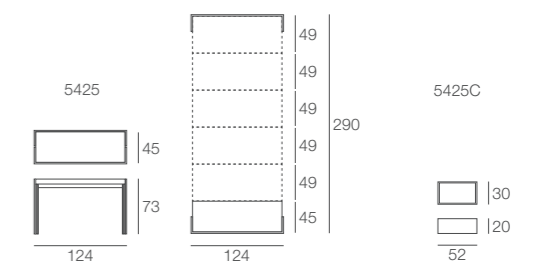



design Norberto Delfinetti e Monica Bernasconi

millerighe

Consolle con struttura
in massello di frassino.
Ripiano in vetro naturale.
Finiture disponibili:
FN frassino naturale,
WG wengé, NC noce,
TB tabacco.

Console with struc-
ture in solid ash.
Natural glass shelf.
Available finishings:
FN natural ash,
WG wengé, NC
walnut, TB tobacco.

console
cod.5532

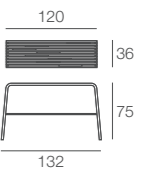



arch. Fabio Rebosio

kendo

Consolle con struttura e piano placcati frassino. Ripiano in vetro naturale. Finiture disponibili: WG wengé, NC noce, TB tabacco, Laccato opaco poro aperto.

Console with structure and top veneered in ash. Natural glass shelf. Available finishings: WG wengé, NC walnut, TB tobacco, Open pore matt lacquered.

console
cod.5349

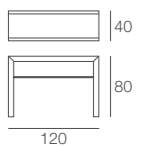

CHAIRS & ARMCHAIRS

sedie e
poltroncine

betty
lady
greta
elite
dafne
ciak
relax
kandy
puffo



Studio Tecnico Pacini&Cappellini

betty

Sedia e poltroncina con struttura in massello di frassino, seduta rivestita in pelle, ecopelle o tessuto della collezione. Finiture disponibili: FN frassino naturale, CL ciliegio americano, WG wengé, NC noce, TB tabacco, Laccato opaco poro aperto. Decapato.

Chair and small armchair with structure in solid ash, seat covered in leather, eco-leather or fabric of the collection. Available finishings: FN natural ash, CL american cherry, WG wengé, NC walnut, TB tobacco, Open pore matt lacquered. Decapé.

chair
cod.5448
armchair
cod.5448.1



5448

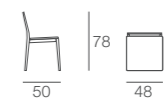

5448.1

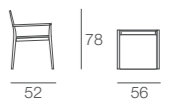



Studio Tecnico Pacini&Cappellini

lady

Sedia con struttura in massello di frassino, seduta rivestita in pelle, ecopelle o tessuto della collezione. Finiture disponibili: WG wengé, NC noce, TB tabacco, Laccato opaco poro aperto.

Chair with structure in solid ash, covered in leather, eco-leather or fabric of the collection. Available finishings: WG wengé, NC walnut, TB tobacco, Open pore matt lacquered.

chair
cod.5435
armchair
cod.5435.1

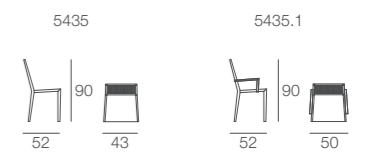



Studio Tecnico Pacini&Cappellini

greta

Sedia con struttura
in poliuretano espanso
flessibile, interamente
rivestita nei tessuti
della collezione.
Piedini in massello.

Chair with structure in
flexible polyurethane
foam, completely
covered in the fabrics
of the collection.
Feet in solid wood.

chair
5427

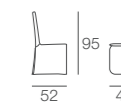



Studio Tecnico Pacini&Cappellini

elite/dafne

Sedia con struttura in metallo, rivestita in cuoio rigenerato nei colori della collezione.

Chair with structure in metal, covered in regenerated leather in the colours of the collection.

Elite chair
cod.5434
Dafne chair
cod.5445



5434

5445

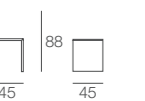
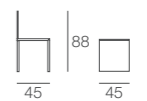



Studio Tecnico Pacini&Cappellini

ciak

Sedia pieghevole con struttura in metallo verniciato color alluminio, seduta e schienale placcati frassino o laccati. Finiture disponibili: CL ciliegio americano, WG wengé, NC noce, TB tabacco, Laccato opaco poro aperto, Laccato opaco poro chiuso.

Chair with structure in metal painted, seat and back ash veneered or lacquered. Available finishings: CL american cherry, WG wengé, NC walnut, TB tobacco, Open pore matt lacquered, Closed pore matt lacquered.

chair
cod.5436

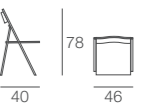



design Studio Controdesign

relax

Poltroncina in massello di frassino, rivestita in pelle o ecopelle della collezione. Finiture disponibili: WG wengé, NC noce, TB tabacco, Laccato opaco poro aperto.

Small armchair in solid ash, covered in leather or eco-leather of the collection. Available finishings: WG wengé, NC walnut, TB tobacco, Open pore matt lacquered.

armchair
cod.5439

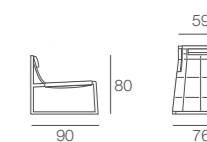



Studio Tecnico Pacini&Cappellini

kandy

Poltroncina con struttura
in massello di frassino,
rivestita in pelle, ecopelle
o tessuto della collezione.
Finiture disponibili:
FN frassino naturale,
CL ciliegio americano,
WG wengé, NC noce,
TB tabacco, Laccato
opaco poro aperto.

Small armchair with solid
ash structure, covered
in leather, eco-leather or
fabric of the collection.
Available finishings:
FN natural ash,
CL american cherry,
WG wengé, NC walnut,
TB tobacco, Open
pore matt lacquered.

armchair
cod.5440

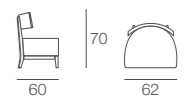



design Studio Controdesign

puffo

Pouf con struttura rivestita in pelle o eco-pelle della collezione. Dotato di vano contenitore con sacca sfoderabile.

Pouf with structure covered in leather or eco-leather of the collection. Equipped with glove compartment with removable sack.

pouf
cod.5345



BOOKCASES

liberie

maze
tree
tres
babele
reflex



design Norberto Delfinetti e Monica Bernasconi

maze

Libreria componibile da parete con struttura placcata noce canaletto o in fibra di legno. Possibilità di fissaggio in orizzontale o verticale. Finiture disponibili: NK noce canaletto, Laccato opaco poro chiuso.

Modular wall bookcase with structure veneered canaletto walnut or fiberboard. It is possible to hang it vertically or horizontally. Available finishings: NK canaletto walnut, Closed pore matt lacquered.

bookcase
cod.5543
cod.5543.1

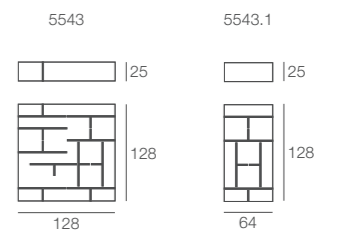



arch. Fabio Rebosio

tree

Libreria da parete con struttura placcata frassino. Pannello di sostegno placcato o in materiale decorativo effetto tessuto. Finiture disponibili: WG wengé, NC noce, TB tabacco, Laccato opaco poro aperto.

Wall bookcase with structure veneered in ash. Supporting panel veneered or in decorative material with fabric effect. Available finishings: WG wengé, NC walnut, TB tobacco, Open pore matt lacquered.

bookcase
cod.5542

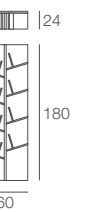



design Norberto Delfinetti e Monica Bernasconi

tres

Libreria con struttura
in metallo cromato.
Ripiani placcati frassino
o laccati. Finiture
disponibili: WG wengé,
NC noce, TB tabacco,
Laccato opaco poro
chiuso.

Bookcase with structure
in chrome-plated metal.
Shelves veneered in ash
or lacquered. Available
finishes: WG wengé,
NC walnut, TB tobacco,
Closed pore matt
lacquered.

bookcase
cod.5550.2

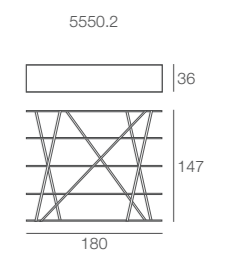

design Norberto Delfinetti e Monica Bernasconi

babele

bookcase
cod.5553

Libreria con struttura
placcata frassino
o in fibra di legno.
A richiesta, cassetto
laccato opaco con frontale
in cuoio bianco o nero.
Finiture disponibili:
WG wengé, NC noce,
TB tabacco, Laccato
opaco poro aperto, Lac-
cato opaco poro chiuso.

Bookcase with structure
veneered in ash or in
fiberboard. On request,
matt lacquered drawer
with front in white or
black leather. Available
finishings: WG wengé,
NC walnut, TB tobacco,
Open pore matt lac-
quered, Closed pore
matt lacquered.

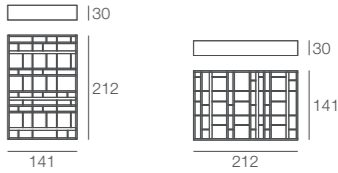



Studio Tecnico Pacini&Cappellini

reflex

Libreria con struttura
placcata frassino e bordi
in massello. Interno
rivestito in materiale
decorativo effetto
tessuto. Finiture di-
sponibili: WG wengé,
NC noce, TB tabacco.

Bookcase with structure
veneered in ash and
edges in solid wood.
Inside covering in
decorative material with
fabric effect. Available
finishings: WG wengé,
NC walnut, TB tobacco.

bookcase
cod.5545



TV STANDS

porta tv

ghost
luna
totem
screen
cast
sistema miki
krea
basic

design Danilo Bonfanti e Gabriele Moscatelli

ghost

tv stand
cod.5334

Porta TV orientabile con elemento libreria placcato o in fibra di legno, posizionabile a destra o sinistra del pannello porta TV. Pannello apribile ed attrezzato sul retro con vani porta CD/DVD o uso bar. Particolari in metallo verniciato. Finiture disponibili: Pannello - Laccato opaco poro chiuso, Laccato brillante. Libreria - WG wengé, NC noce, TB tabacco, Laccato opaco poro chiuso.

Adjustable TV stand with bookcase unit veneered or in fiberboard, that can be positioned to the right or the left of the TV panel. The panel can be opened and is equipped on the back with CD/DVD compartments or can be used as a bar unit. Details in painted metal. Available finishings: Panel - Closed pore matt lacquered, Glossy lacquered. Bookcase - WG wengé, NC walnut, TB tobacco, Closed pore matt lacquered.

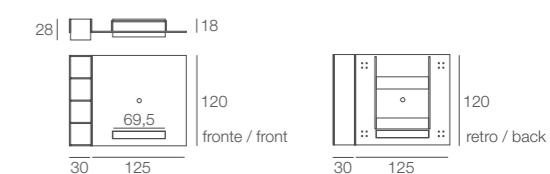



arch. Fabio Rebosio

luna

tv stand
cod.5331

Porta TV orientabile con pannello curvato placcato frassino o in plexiglas, dotato di barra porta TV universale. Mensola in vetro naturale temperato. Particolari in metallo cromato. Finiture disponibili: WG wengé, NC noce, TB tabacco, Laccato opaco poro aperto, Plexiglas bianco o nero.

Adjustable TV stand with curved panel veneered in ash or in plexiglas, equipped with universal bar. Shelf in tempered natural glass. Details in chrome-plated metal. Available finishings: WG wengé, NC walnut, TB tobacco, Open pore matt lacquered, White or black plexiglas.

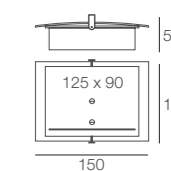



arch. Fabio Rebosio

totem

Elemento porta TV con base rotante a 360° o fissa rivestita in supermirror lucido. Pannello porta TV placcato frassino o in fibra di legno, mensola in vetro naturale temperato. A richiesta, pannello in plexiglas bianco o nero. Finiture disponibili: WG wengé, NC noce, TB tabacco, Laccato opaco poro chiuso, Laccato brillante.

TV stand with 360° swiveling or fix base, covered with polished supermirror finish. Plasma TV panel veneered in ash or in fiberboard. Shelf in tempered natural glass. On request, panel in white or black plexiglas. Available finishings: WG wengé, NC walnut, TB tobacco, Closed pore matt lacquered, Glossy lacquered.

tv stand
cod.5328

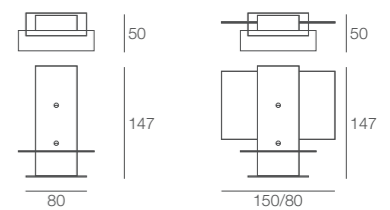



arch. Fabio Rebosio

screen

Elemento porta TV, HI-FI con base orientabile a 360° o fissa. Dotato di contenitori interni o vani a giorno per CD, DVD e libri. Attrezzabile su entrambi i lati con mensole in vetro naturale temperato. Finiture disponibili: Laccato opaco poro chiuso, Laccato brillante.

TV and HI-FI stand element with 360° swivelling or fixed base. Comes with internal containers or open compartments for CDS, DVDS and books. Can be fitted on both sides with tempered natural glass shelves. Available finishings: Closed pore matt lacquered, Glossy lacquered.

tv stand
cod.5300
cod.5400

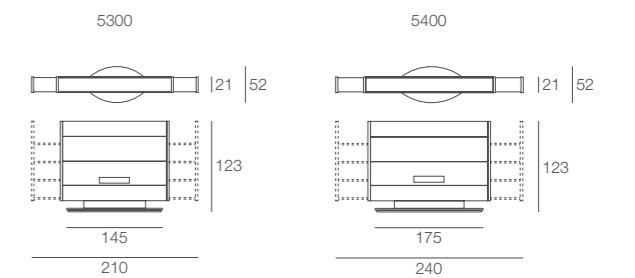





arch. Fabio Rebosio

cast

Elemento porta TV
con base rotante o fissa.
Struttura in fibra di legno
laccata. Ripiano in vetro
naturale. Finiture dispo-
nibili: Laccato opaco poro
chiuso, Laccato brillante.

TV stand with swivelling
or fixed base. Structure
lacquered in fiberboard,
shelf in natural glass.
Available finishings:
Closed pore matt lac-
quered, Glossy lacquered.

tv stand
cod.5332

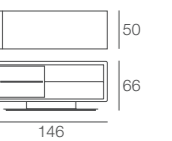



comp. 4

design Norberto Delfinetti e Monica Bernasconi **sistema miki**

Sistema porta-TV
 composto da pannello in
 fibra di legno, di mensola
 in vetro temperato, barra
 porta TV universale ed
 elemento passacavi. Basi
 laccate con cassetto.
 Finiture disponibili: Lac-
 cato opaco poro chiuso,
 Laccato brillante.

TV stand system
 composed of panel in
 fiberboard, shelf in
 tempered glass, universal
 bar for TV and cable
 holes. Lacquered bases
 with drawer. Available
 finishes: Closed pore
 matt lacquered, Glossy
 lacquered.

tv stand
 comp. 2
 comp. 4



comp. 2

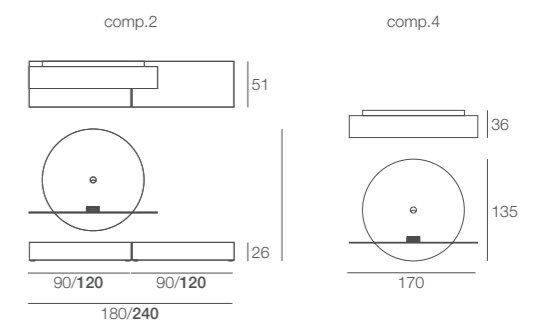



design Danilo Bonfanti e Gabriele Moscatelli

krea

Elemento porta-TV componibile con struttura in fibra di legno. Composto da cassetti e elementi a giorno con ripiani estraibili. Pre-disposto per cablaggio a scomparsa di sistema TV e HI-FI. Finiture disponibili: Laccato opaco poro chiuso, Laccato brillante.

Modular TV stand with structure in fiberboard. Drawers and open compartment unit with pull-out shelves. Hidden cabling set up for TV and HI-FI system. Available finishings: Open pore matt lacquered, Glossy lacquered.

tv stand comp. 2



Elemento vani a giorno (dettagli)
Open compartment unit (details)

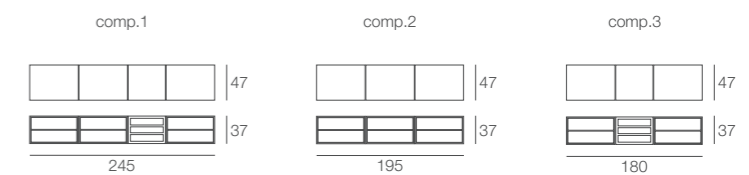

comp. 2





comp. A

Studio Tecnico Pacini&Cappellini

basic

Pensili orizzontali e verticali con ripiano in vetro naturale, apertura push and pull. Finiture disponibili: Laccato opaco poro chiuso, Laccato brillante.

Horizontal and vertical wall units with shelf in natural glass, push and pull opening. Open compartment unit with pull-out shelves. Available finishings: Closed pore matt lacquered, Glossy lacquered.

wall units
comp. A
comp. B
comp. C



comp. B

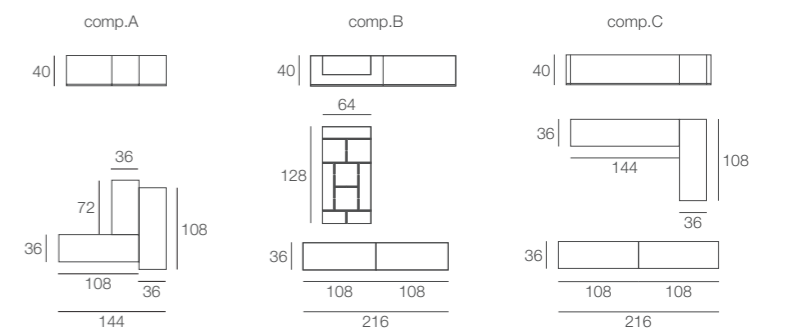



CUPBOARDS

madie

line
sistema maddy
sistema maddy 2
tiffany



design Giuliano Cappelletti

line

Madia con struttura
placcata ed in massello
di frassino. Piano supe-
riore placcato. Ripiani
interni in vetro naturale.
Finiture disponibili:
WG wengé, NC noce,
TB tabacco, Laccato
opaco poro aperto.

Cupboard with structure
veneered and in solid
ash. Veneered top. Inner
shelves in natural glass.
Available finishings:
WG wengé, NC walnut,
TB tobacco, Open pore
matt lacquered.

cupboard
cod.5574





comp. 1

design Norberto Delfinetti e Monica Bernasconi

sistema maddy

Madia a moduli con struttura e ante placcate o laccate. Piano superiore in legno o in vetro verniciato. Finiture disponibili: WG wengé, NC noce, TB tabacco, Laccato opaco poro chiuso, Laccato brillante.

Modular cupboard with structure and doors veneered or lacquered. Top in wood or in lacquered glass. Available finishings: WG wengé, NC walnut, TB tobacco, Closed pore matt lacquered, Glossy lacquered.

cupboard
comp. 1
comp. 6



comp. 6

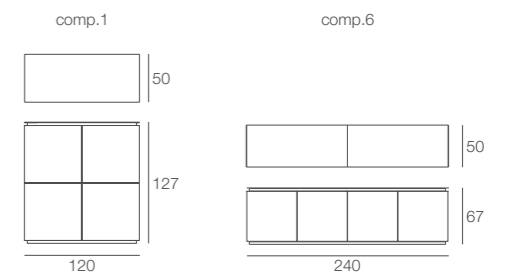



design Norberto Delfinetti e Monica Bernasconi **sistema maddy 2**

Madia a moduli con struttura e ante placcate o laccate. Piano superiore in legno o in vetro verniciato. Finiture disponibili: WG wengé, NC noce, TB tabacco, Laccato opaco poro chiuso, Laccato brillante.

Modular cupboard with structure and doors veneered or lacquered. Top in wood or in lacquered glass. Available finishings: WG wengé, NC walnut, TB tobacco, Closed pore matt lacquered, Glossy lacquered.

cupboard comp. 2

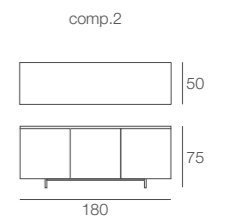



design Elena Viganò

tiffany

Cassetiera, settimanale e comodino con struttura placcata frassino o in fibra di legno. Cassetti, dotati di guide bluemotion, con frontali in massello di frassino. Finiture disponibili: WG wengé, NC noce, TB tabacco, Laccato opaco poro aperto, Laccato opaco poro chiuso, Laccato brillante.

Chest of drawers, seven drawer and bedside table with structure veneered in ash or in fiberboard. Drawers, equipped with bluemotion guides, with fronts in solid ash. Available finishings: WG wengé, NC walnut, TB tobacco, Open pore matt lacquered, Closed pore matt lacquered, Glossy lacquered.

seven-drawer
cod.5572

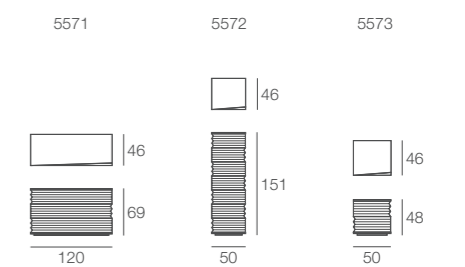

design Elena Viganò

tiffany

chest of drawers
cod.5571
bedside table
cod.5573



DESKS

scrittoi

athos
athena



arch. Fabio Rebosio

athos

Scrittoio con struttura
in massello di frassino
dotato di cassetto estra-
bile ed inserto in cuoio,
pelle o ecopelle. Finiture
disponibili: FN frassino
naturale, CL ciliegio
americano, WG wengé,
NC noce, TB tabacco.
Laccato opaco poro
aperto.

Writing desk with
structure in solid ash,
equipped with pull-out
drawer and leather or
eco-leather insert.
Available finishings:
FN natural ash,
CL american cherry,
WG wengé, NC walnut,
TB tobacco, Open pore
matt lacquered.

desk
cod.5470

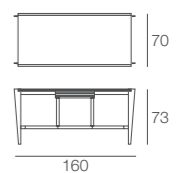



arch. Fabio Rebosio

athena

Scrittoio con struttura
in massello di frassino
e piani placcati, con
cassetto. Finiture
disponibili: CL ciliegio
americano, WG wengé,
NC noce, TB tabacco,
Laccato opaco poro
aperto.

Writing desk with
structure in solid ash
and veneered surfaces,
with drawer. Available
finishings: CL american
cherry, WG wengé,
NC walnut, TB tobacco,
Open pore matt
lacquered.

desk
cod.5471

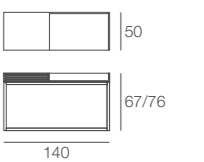

COFFEE TABLES

tavolini

master
corallo
regal
atollo
scacco
mosaico
banner
vogue
pocket
millerighe
rebus
plano
prisma
city
zen
duna
ambo
one
fly
cin-cin
isola
gong
drink



arch. Fabio Rebosio

master

Tavolino con struttura
placcata frassino o in
fibra di legno.
Piano superiore in vetro
naturale. Particolari in
metallo. Finiture dispo-
nibili: WG wengé,
NC noce, TB tabacco,
Laccato opaco poro
chiuso, Laccato brillante.

Coffee table with struc-
ture veneered in ash
or in fiberboard.
Upper surface in natural
glass. Metal details.
Available finishings:
WG wengé, NC walnut,
TB tobacco, Closed
pore matt lacquered,
Glossy lacquered.

coffee table
cod.5336

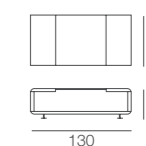



arch. Fabio Rebosio

corallo

Tavolino con piano superiore in vetro naturale e piano inferiore placcato o laccato. Particolari in alluminio brillantato. Finiture disponibili: CL ciliegio americano, WG wengé, NC noce, TB tabacco, Laccato opaco poro chiuso, Laccato brillante.

Coffee table with upper surface in natural glass and lower surface veneered or lacquered. Details in polished aluminium. Available finishings: CL american cherry, WG wengé, NC walnut, TB tobacco, Closed pore matt lacquered, Glossy lacquered.

coffee table
cod.5376



5376.85



5376.120

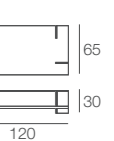



arch. Fabio Rebosio

regal

Tavolino con piani laccati.
Tavolino di servizio con
top in vetro verniciato e
ripiano laccato. Finiture
disponibili: Laccato
opaco poro chiuso,
Laccato brillante.

Lacquered coffee table.
Lacquered serving table
with top in lacquered
glass. Available finishings:
Closed pore matt lac-
quered, Glossy lacquered.

coffee table
cod.5367

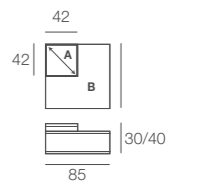



Studio Tecnico Pacini&Cappellini

atollo

Tavolino con piani in alluminio specchiato o placcati frassino. Piano scorrevole in fibra di legno su vano contenitore. Finiture disponibili: WG wengé, NC noce, TB tabacco, Laccato opaco poro chiuso, Laccato brillante, Specchio.

Coffee table with tops in mirror effect aluminium or veneered in ash. Sliding top in fiberboard on glove compartment. Available finishings: WG wengé, NC walnut, TB tobacco, Closed pore matt lacquered, Glossy lacquered, Mirror.

coffee table
cod.5374

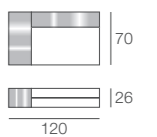



arch. Fabio Rebosio

scacco

Tavolino con struttura
placcata frassino. Pos-
sibilità di inserimento nel
piano di vetro verniciato.
Finiture disponibili:
WG wengé, NC noce,
TB tabacco, Laccato
opaco poro aperto.

Coffee table with struc-
ture veneered in ash.
Possibility of inserting
lacquered glass in the
top. Available finishings:
WG wengé, NC walnut,
TB tobacco, Open
pore matt lacquered.

coffee table
cod.5380

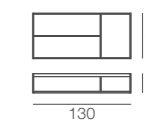



arch. Fabio Rebosio

mosaico

Tavolino con struttura
in massello di frassino.
Vassoi placcati frassino.
Finiture disponibili:
WG wengé, NC noce,
TB tabacco, Laccato
opaco poro aperto.

Coffee table with
structure in solid ash.
Ash veneered trays.
Available finishings:
WG wengé, NC walnut,
TB tobacco, Open pore
matt lacquered.

coffee table
cod.5384

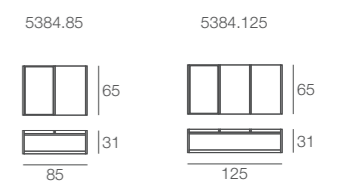



Studio Tecnico Pacini&Cappellini

banner

Tavolino con struttura in metallo cromato. Piano superiore in vetro naturale e piano inferiore placcato frassino o in fibra di legno. Finiture disponibili: WG wengé, NC noce, TB tabacco, Laccato opaco poro aperto, Laccato opaco poro chiuso, Laccato brillante.

Coffee table with structure in chrome-plated metal. Upper surface in natural glass and lower surface veneered in ash or in fiberboard. Available finishings: WG wengé, NC walnut, TB tobacco, Open pore matt lacquered, Closed pore matt lacquered, Glossy lacquered.

coffee table
cod.5323

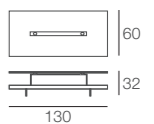



Studio Tecnico Pacini&Cappellini

vogue

Tavolino con struttura in metallo cromato. Piano superiore in vetro naturale e piano inferiore placcato frassino o in fibra di legno. Finiture disponibili: WG wengé, NC noce, TB tabacco, Laccato opaco poro aperto, Laccato opaco poro chiuso.

Coffee table with structure in chrome-plated metal. Upper surface in natural glass and lower surface veneered in ash or in fiberboard. Available finishings: WG wengé, NC walnut, TB tobacco, Open pore matt lacquered, Closed pore matt lacquered.

coffee table
cod.5382

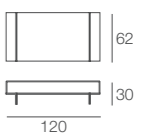



arch. Fabio Rebosio

pocket

Tavolino placcato frassino con contenitore in materiale decorativo effetto tessuto. Possibilità di inserimento nel piano di vetro verniciato. Piedini in alluminio. Finiture disponibili: WG wengé, NC noce, TB tabacco, Laccato opaco poro aperto.

Coffee table veneered in ash with compartment in decorative material with fabric effect. Possibility of inserting lacquered glass in the top. Aluminium feet. Available finishings: WG wengé, NC walnut, TB tobacco, Open pore matt lacquered.

coffee table
cod.5383

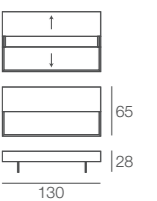



design Norberto Delfinetti e Monica Bernasconi

millerighe

Tavolino con struttura in massello di noce canaletto o frassino. A richiesta: cuscino in appoggio rivestito nei tessuti della collezione.
 Finiture disponibili:
 FN frassino naturale,
 CL ciliegio americano,
 WG wengé, NC noce,
 TB tabacco, NK noce canaletto.

Coffee table with structure in solid canaletto walnut or ash. Upon request: seat cushion covered in the fabrics of the collection.
 Available finishings:
 FN natural ash,
 CL american cherry,
 WG wengé, NC walnut,
 TB tobacco, NK canaletto walnut.

coffee table
 cod.5531
 cod.5533

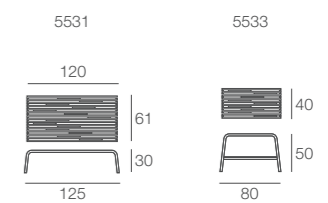



arch. Fabio Rebosio

rebus

Tavolino con struttura in massello di frassino. Piano superiore in vetro naturale e piano inferiore placcato frassino. Finiture disponibili: CL ciliegio americano, WG wengé, NC noce, TB tabacco, Laccato opaco poro aperto.

Coffee table with structure in solid ash. Upper surface in natural glass and lower surface veneered in ash. Available finishings: CL american cherry, WG wengé, NC walnut, TB tobacco, Open pore matt lacquered.

coffee table
cod.5387

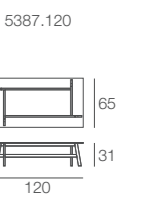
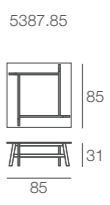



arch. Fabio Rebosio

plano

Tavolino con struttura in massello di frassino e piani placcati. Pouf con struttura in poliuretano espanso indeformabile a densità differenziata. Rivestimento in pelle, ecopelle o tessuto della collezione. Finiture disponibili: CL ciliegio americano, WG wengé, NC noce, TB tabacco, Laccato opaco poro aperto.

Coffee table with structure in solid ash and veneered tops. Pouf with structure in polyurethane foam with different density. Covered in leather, eco-leather or fabric of the collection. Available finishings: CL american cherry, WG wengé, NC walnut, TB tobacco, Open pore matt lacquered.

coffee table
cod.5392
pouf
cod.5343

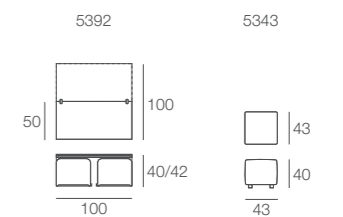



Studio Tecnico Pacini&Cappellini

prisma

Tavolino con struttura
in massello di frassino.
Piano placcato frassino
o in marmo lucido.
Finiture disponibili:
FN frassino naturale,
WG wengé, NC noce,
TB tabacco, Laccato
opaco poro aperto.

Coffee table with
structure in solid ash.
Top veneered ash or
in polished marble.
Available finishings:
FN natural ash, WG
wengé, NC walnut,
TB tobacco, Open
pore matt lacquered.

coffee table
cod.5390

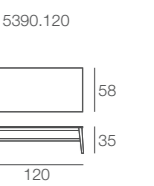
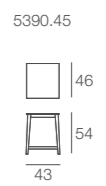



arch. Fabio Rebosio

city

coffee table
cod.5391

Tavolino con struttura in massello di noce canaletto o frassino. Piano in legno placcato noce canaletto, frassino o in marmo lucido. Finiture disponibili: FN frassino naturale, WG wengé, NC noce, TB tabacco, NK noce canaletto, Laccato opaco poro aperto.

Coffee table with structure in solid canaletto walnut or ash. Top veneered canaletto walnut, ash or in polished marble. Available finishings: FN natural ash, WG wengé, NC walnut, TB tobacco, NK canaletto walnut, Open pore matt lacquered.





design Norberto Delfinetti e Monica Bernasconi

zen

Tavolino a ponte in
vetro curvato naturale
o verniciato nero.

Bridge-shaped coffee
table in curved glass,
natural or lacquered black.

coffee table
cod.5919
cod.5920

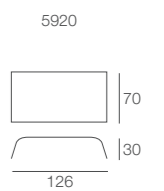
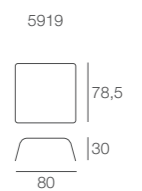



design Norberto Delfinetti e Monica Bernasconi

zen

Tavolino di servizio in
vetro curvato naturale
o verniciato nero.

Serving coffee table in
curved glass, natural or
lacquered black.

coffee table
cod.5930





Studio Tecnico Pacini&Cappellini

duna

Tavolino in vetro
naturale curvato.

Coffee table in
curved natural glass.

coffee table
cod.5935

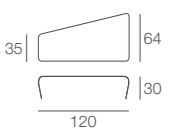



arch. Fabio Rebosio

ambo

Coppia di tavolini con
struttura in massello di
frassino. A richiesta,
piani in vetro verniciato.
Finiture disponibili:
WG wengé, NC noce,
TB tabacco, Laccato
opaco poro aperto.

Pair of coffee tables
with structure in solid
ash. On request, tops
in lacquered glass.
Available finishings:
WG wengé, NC walnut,
TB tobacco, Open
pore matt lacquered.

coffee table
cod.5364



A B 42/50
45/52
42/50



design Elena Viganò

one

Tavolino di servizio
con struttura in metallo
cromato. Piani placcati
frassino, in vetro verni-
ciato o in marmo lucido.
Finiture disponibili:
WG wengé, NC noce,
TB tabacco, Laccato
opaco poro aperto.

Serving coffee table
with structure in
chrome-plated metal.
Tops veneered in ash,
in lacquered glass
or in polished marble.
Available finishings:
WG wengé, NC walnut,
TB tobacco, Open
pore matt lacquered.

coffee table
cod.5451





design Norberto Delfinetti e Monica Bernasconi

fly

coffee table
cod.5452

Tavolino di servizio
con struttura in metallo
cromato. Piano placcato
frassino, in vetro verni-
ciato o in marmo lucido.
Finiture disponibili:
WG wengé, NC noce,
TB tabacco, Laccato
opaco poro aperto.

Serving coffee table
with structure in
chrome-plated metal.
Top veneered in ash,
in lacquered glass or
in polished marble.
Available finishings:
WG wengé, NC walnut,
TB tobacco, Open
pore matt lacquered.

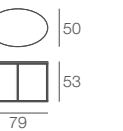



design Danilo Bonfanti e Gabriele Moscatelli

cin-cin

Coppia di tavolini con struttura in metallo cromato. Piani in vetro verniciato, in legno placcato frassino o laccato. Finiture disponibili: WG wengé, NC noce, TB tabacco, Laccato opaco poro chiuso, Laccato brillante.

Pair of coffee tables with structure in chrome-plated metal. Tops in lacquered glass, veneered ash or lacquered fiberboard. Available finishings: WG wengé, NC walnut, TB tobacco, Closed pore matt lacquered, Glossy lacquered.

coffee table
cod.5455

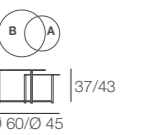



design Norberto Delfinetti e Monica Bernasconi

isola

Tavolino con struttura
in massello di frassino.
Piano superiore in vetro
naturale e piano inferiore
placcato. Finiture
disponibili: FN frassino
naturale, WG wengé,
NC noce, TB tabacco,
Laccato opaco
poro aperto.

Coffee table with
structure in solid ash.
Upper surface in natural
glass and lower surface
veneered. Available
finishings: FN natural
ash, WG wengé, NC
walnut, TB tobacco,
Open pore matt
lacquered.

coffee table
cod.5537
cod.5538



5537



54
Ø 50

5538



34
Ø 60



Studio Tecnico Pacini&Cappellini

gong

Tavolino con struttura e piano/vassoio in massello di frassino. Finiture disponibili: FN frassino naturale, WG wengé, NC noce, TB tabacco, Laccato opaco poro aperto.

Coffee table with structure and top/tray in solid ash. Available finishings: FN natural ash, WG wengé, NC walnut, TB tobacco, Open pore matt lacquered.

coffee table
cod.5388



5388.40

5388.60

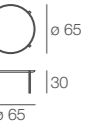
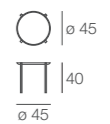



Studio Tecnico Pacini&Cappellini

drink

Tavolino con struttura
in massello, piano
placcato frassino o
in fibra di legno.
Finiture disponibili:
WG wengé, NC noce,
TB tabacco, Laccato
opaco poro aperto, Lac-
cato opaco poro chiuso.

Coffee table with
structure in solid wood,
top veneered in ash or
in fiberboard. Available
finishings: WG wengé,
NC walnut, TB tobacco,
Open pore matt lac-
quered, Closed pore
matt lacquered.

coffee table
cod.5457
cod.5458



5457

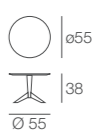

5458



ACCESSORIES

accessori

futura
welcome
l'albero
tower
vanity
oblò
regolo
gallery
kiara
moon
olimpo
gossip
fish
margherita
binario
dado
box 1
box 2



A



B

design Studio Controdesign

futura

Elemento da ingresso con anta placcata e specchio con apertura a destra o a sinistra. Possibilità di varie attrezzature per l'interno rifinito con materiale decorativo effetto tessuto. Finiture disponibili: CL ciliegio americano, WG wengé, NC noce, TB tabacco, Laccato opaco poro aperto.

Entrance unit with veneered door and mirror opening right or left. Possibility of different accessories for internal compartment refined with decorative material with fabric effect. Available finishings: CL american cherry, WG wengé, NC walnut, TB tobacco, Open pore matt lacquered.

entrance unit
cod.5530



interno / inside: A interno / inside: B

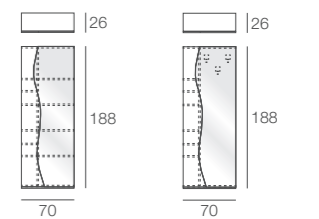



arch. Fabio Rebosio

welcome

Elemento da ingresso
placcato frassino o in
fibra di legno. Specchio
scorrevole con mec-
canismo in alluminio.
Finiture disponibili:
WG wengé, NC noce,
TB tabacco, Laccato
opaco poro aperto, Lac-
cato opaco poro chiuso.

Entrance unit veneered
in ash or in fiberboard.
Sliding mirror with
aluminium mechanism.
Available finishings:
WG wengé, NC walnut,
TB tobacco, Open pore
matt lacquered, Closed
pore matt lacquered.

entrance unit
cod.5516

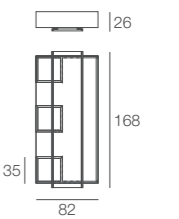



design Norberto Delfinetti e Monica Bernasconi

l'albero

Elemento da ingresso
placcato frassino su
fibra di legno. Dotato
di pomoli cromati o di
uccellini appendiabiti in
metallo verniciato nero.
Finiture disponibili:
FN frassino naturale,
WG wengé, NC noce,
TB tabacco, Laccato
opaco poro aperto.

Entrance unit veneered
ash on fiberboard.
Equipped with chrome-
plated knobs or "birds"
clothes-hook in black
painted metal. Available
finishings: FN natural
ash, WG wengé, NC
walnut, TB tobacco,
Open pore matt
lacquered.

entrance unit
cod.5514

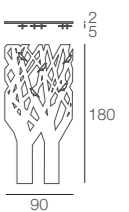



design Elena Viganò

tower

Elemento appendiabiti da parete con struttura placcata e supporti in metallo cromato. Specchio da parete con mensola e struttura placcata. Possibilità di creare varie composizioni. Finiture disponibili: CL ciliegio americano, WG wengé, NC noce, TB tabacco, Laccato opaco poro aperto.

Wall hanging unit with veneered structure and supports in chrome-plated metal. Wall mirror with shelf and veneered structure. Possibility of realizing different compositions. Available finishings: CL american cherry, WG wengé, NC walnut, TB tobacco, Open pore matt lacquered.

wall unit
cod.5513
cod.5515

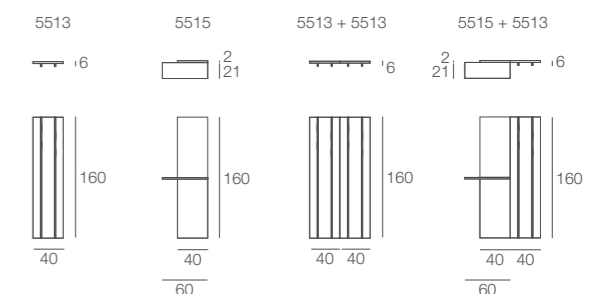



design Norberto Delfinetti e Monica Bernasconi

vanity

Elemento da ingresso
in vetro naturale o ver-
niciato nero. Possibilità
di aggiungere mensola
placcata frassino o in
fibra di legno. Finiture
disponibili: Laccato
opaco poro aperto,
Laccato opaco poro
chiuso, Laccato brillante.

Entrance unit in natural
or painted black glass.
Possibility of adding
shelf veneered in ash
or in fiberboard.
Available finishings:
Open Pore matt lac-
quered, Closed pore
matt lacquered, Glossy
lacquered.

entrance unit
cod.5910

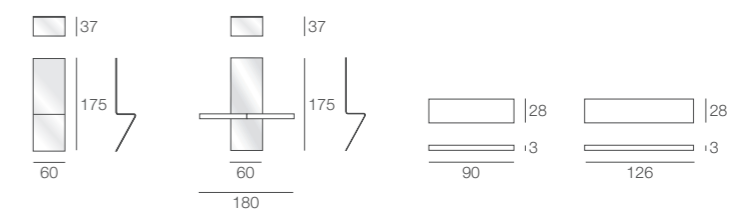
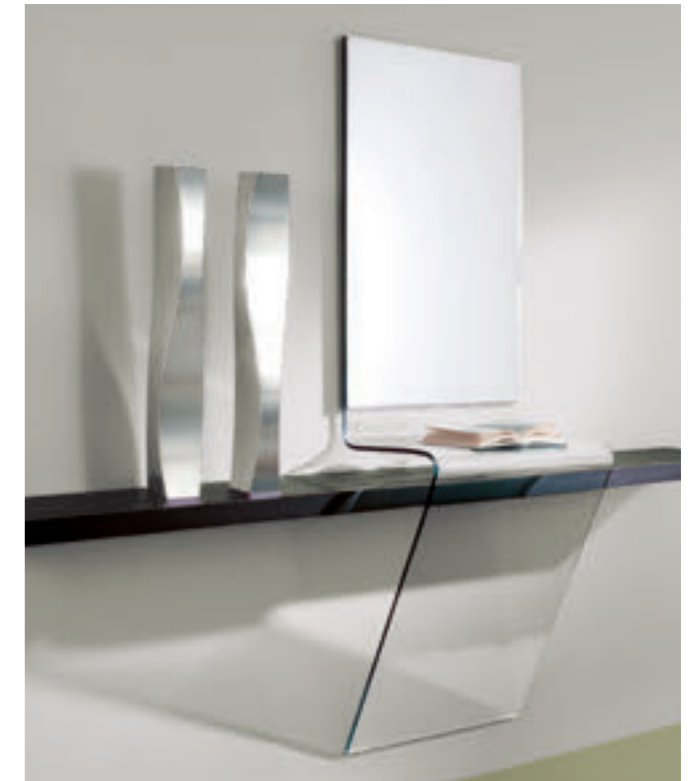



design Studio Controdesign/arch. Fabio Rebosio

oblò/regolo

Oblò - Specchio da parete con cornice placcata frassino o in fibra di legno. Possibilità di creare varie composizioni. Finiture disponibili: WG wengé, NC noce, TB tabacco, Laccato opaco poro aperto, Laccato opaco poro chiuso.

Oblò - Wall mirror with veneered or lacquered frame. Assembling possible in different configurations. Available finishings: WG wengé, NC walnut, TB tobacco, Open pore matt lacquered, Closed pore matt lacquered.

oblò-mirror
cod.5527
regolo-shelf
cod.5581

Regolo - Mensola con cassetto placcata frassino. Cassetto con frontale in massello. Finiture disponibili: CL ciliegio americano, WG wengé, NC noce, TB tabacco, Laccato opaco poro aperto.

Regolo - Shelf with drawer veneered in ash. Drawer front in solid wood. Available finishings: CL american cherry, WG wengé, NC walnut, TB tobacco, Open pore matt lacquered.

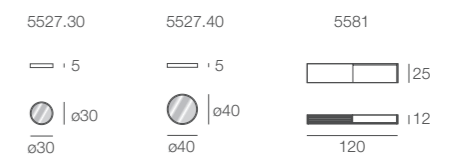



arch. Fabio Rebosio

gallery/kiara

Gallery - Mensola con cassetto placcata frassino. Cassetto con frontale in massello. Finiture disponibili: CL ciliegio americano, WG wengé, NC noce, TB tabacco, Laccato opaco poro aperto.

Gallery - Shelf with drawer veneered in ash. Drawer front in solid wood. Available finishings: CL american cherry, WG wengé, NC walnut, TB tobacco, Open pore matt lacquered.

gallery-shelf
cod.5582
kiara-mirror
cod.5517

Kiara - Specchio da parete placcato frassino. Possibilità di fissaggio in diverse posizioni. Finiture disponibili: WG wengé, NC noce, TB tabacco, Laccato opaco poro aperto.

Kiara - Wall mirror veneered in ash. Assembling possible in different positions. Available finishings: WG wengé, NC walnut, TB tobacco, Open pore matt lacquered.

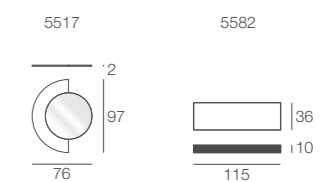



design Elena Viganò

moon

Specchio da parete con
struttura laccata. Finiture
disponibili: Laccato opaco
poro chiuso, Laccato
brillante.

Wall mirror with
lacquered structure.
Available finishings:
Closed pore matt lac-
quered, Glossy lacquered.

mirror
cod.5519

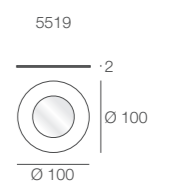



design Elena Viganò/Studio Tecnico Pacini&Cappellini **olimpo/gossip**

Olimpo - Specchiera
con struttura laccata.
Finiture disponibili:
Laccato opaco poro
chiuso, Laccato brillante.

Olimpo - Mirror
with lacquered structure.
Available finishings: Closed
pore matt lacquered,
Glossy lacquered.

olimpo-mirror
cod.5520
gossip-mirror
cod.5524

Gossip - Specchio placca-
to frassino. Possibilità di
fissaggio in diverse posizioni.
Finiture disponibili: FN
frassino naturale, CL ciliegio
americano, WG wengé,
NC noce, TB tabacco,
Laccato opaco poro aperto.

Gossip - Mirror veneered
in ash. Assembling possi-
ble in different positions.
Available finishings:
FN natural ash, CL ameri-
can cherry, WG wengé,
NC walnut, TB tobacco,
Open pore matt lacquered.

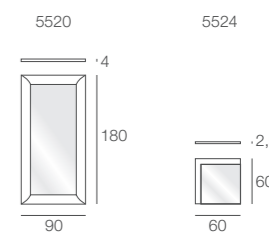



design Elena Viganò

fish

Specchio appendiabiti
da parete con particolari
in metallo cromato.

Hanging wall mirror
with chrome-plated
metal details.

hanging wall mirror
cod.5528



design Elena Viganò

margherita

Specchio con petali.
Apertura in diverse
posizioni.

Mirror with petals.
Opening in different
positions.

mirror
cod.5529

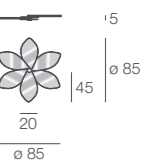



arch. Fabio Rebosio

binario

Mensola placcata noce canaletto, frassino o in fibra di legno. Ripiano in vetro temperato. Finiture disponibili: WG wengé, NC noce, TB tabacco, NK noce canaletto, Laccato opaco poro aperto, Laccato opaco poro chiuso, Laccato brillante.

Shelf veneered in canaletto walnut, ash or in fiberboard. Shelf in tempered glass. Available finishings: WG wengé, NC walnut, TB tobacco, NK canaletto walnut, Open pore matt lacquered, Closed pore matt lacquered, Glossy lacquered.

shelf
cod.5597

5597.90

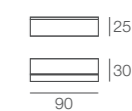

90

5597.120

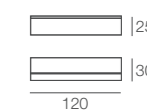

120



arch. Fabio Rebosio

dado

Elemento a giorno
placcato frassino con
particolari in massello.
Fondo in materiale
decorativo effetto tessuto.
Finiture disponibili:
WG wengé, NC noce,
TB tabacco, Laccato
opaco poro aperto.

Open unit veneered
in ash with details in
solid wood. Back in
decorative material
with fabric effect.
Available finishings:
WG wengé, NC walnut,
TB tobacco, Open pore
matt lacquered.

open unit
cod.5587
cod.5588



5587

5588





arch. Fabio Rebosio

box 1/box 2

Elemento porta-prolunghe
verticale o orizzontale
in melamina bianco, con
specchio e appendiabiti in
metallo cromato.

Vertical or horizontal
extensions box in white
melamine, with mirror
and chrome-plated
metal hanger.

extension box
cod.5504
cod.5505

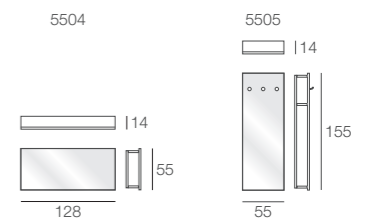

ACCESSORIES

accessori

futura
welcome
l'albero
tower
vanity
oblò
regolo
gallery
kiara
moon
olimpo
gossip
fish
margherita
binario
dado
box 1
box 2

L6
bianco brillante
glossy white

L9
madreperla brillante
glossy pearl

L10
cappuccino brillante
glossy cappuccino colour

L11
grigio fumo brillante
glossy smoke grey

L8
nero brillante
glossy black

L7
rosso brillante
glossy red

laccato brillante
glossy lacquered

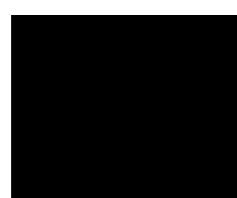
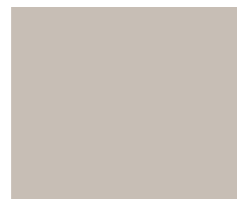
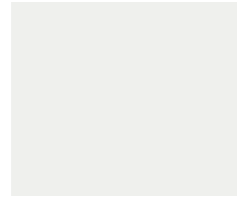

L21
bianco opaco
poro aperto
open pore matt white

laccato opaco poro aperto
open pore matt lacquered



L29
madreperla opaco
poro aperto
open pore matt pearl



L23
cappuccino opaco
poro aperto
open pore matt cappuccino colour

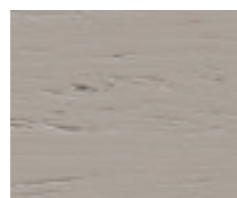

L25
grigio fumo opaco
poro aperto
open pore matt smoke grey



L22
nero opaco
poro aperto
open pore matt black



L24
rosso opaco
poro aperto
open pore matt red



L1
bianco opaco
poro chiuso
closed pore matt white

laccato opaco poro chiuso
closed pore matt lacquered

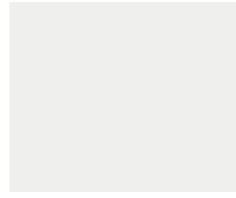

L19
madreperla opaco
poro chiuso
closed pore matt pearl



L3
cappuccino opaco
poro chiuso
closed pore matt cappuccino colour



L5
grigio fumo opaco
poro chiuso
closed pore matt smoke grey



L2
nero opaco
poro chiuso
closed pore matt black

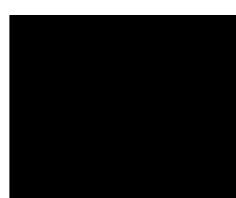

L4
rosso opaco
poro chiuso
closed pore matt red



L40
beige microgoffrato
microembossed beige

laccato opaco poro chiuso microgoffrato
microembossed closed pore matt lacquered

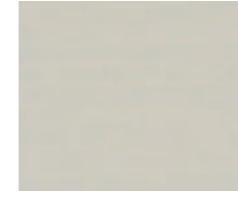

L41
ecrù microgoffrato
microembossed ecrù



L42
fango microgoffrato
microembossed mud



DN
frassino decapato naturale
natural decapè ash

decapati
decapè



DT
frassino decapato tortora
dove decapè ash

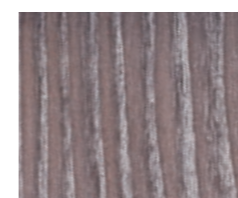

DG
frassino decapato grigio
grey decapè ash



NK
noce canaletto
canaletto walnut

legni
woods



NC
frassino tinto noce
ash stained walnut



TB
frassino tinto tabacco
ash stained tobacco

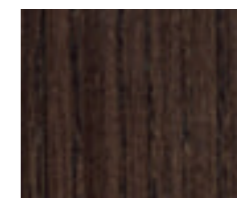

WG
frassino o noce
canaletto tinto wengé
ash or canaletto
walnut stained wengé

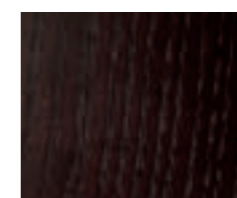

CL
frassino tinto ciliegio americano
ash stained american cherry



FN
frassino naturale
natural ash



C02
sabbia
sand

cimento®



C03
tortora
dove

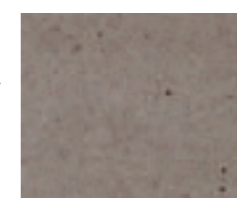

BP
bianco opaco
poro aperto
open pore matt white

finiture decorative (melamina) D
decorative finishes (melamine)



BA
bianco antico
antique white



OL
olmo
elm

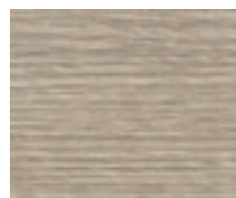

WG
wengé



TS
tessuto
(per rivestimento interno)
fabric
(for interior covering)



BC
marmo bianco carrara lucido
polished white carrara marble

marmi
marble



NM
marmo nero marquinia lucido
polished black marquinia marble

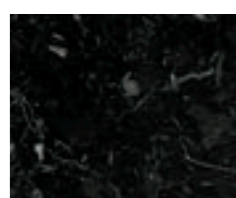

EM
marmo emperador dark lucido
polished dark emperador marble

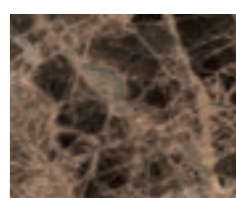

GattiCitterioSchuler
photos: Enrico Colzani
styling: Simona Corti / Maria Grazia Monti
photoengraving: Tonality
printing: Grafiche Boffi
© Pacini&Cappellini, 2016

thanks to:
Angelo Bartesaghi
Artemide
Besana Moquette
Brianform
Chateau D'Ax
Caimi Brevetti
Flexform
Fontana Arte
GB
IVV
Kappa Salotti
Mesa
Penta

Pacini&Cappellini
si riserva il diritto di
apportare, senza preavviso, ogni modifica mirata al miglioramento funzionale e qualitativo dei propri prodotti. Testi e disegni presenti in questo stampato hanno scopo divulgativo: per ogni aspetto tecnico e dimensionale fare riferimento ai listini aziendali e relativi aggiornamenti.

Pacini&Cappellini reserves the rights at all time to apply modifications for the functional or qualitative improvement of its products. Text and drawings present in this brochure have a divulgative purpose: for every technical and dimensional aspect please refer to the company's price lists and their relevant updatings.

Pacini&Cappellini
via Kennedy, 18
22060 Cabiata
Como, Italy

tel 0039 031 767695
fax 0039 031 767588
info@pacini&cappellini.it

www.pacini&cappellini.it

