

Bath Solutions

Solutions de Bain • Soluciones de Baño



Because Bathing
is a daily therapy...



bellian®





 ctesi.

bellian®

Our inspiration born from the very spirit of life, a universe full of detail and beauty.

Notre inspiration est née dans la joie de vivre, un univers plein de détails et de beauté.

Nuestra inspiración nace del propio espíritu de vivir, un universo lleno de detalles y de belleza.



EN

It is with great pleasure that we present to you our "Bath Solutions" catalogue, where you can find integrated bathroom solutions from our brands Ctesi® and Bellian®.

This edition reflects the ever increasing industrial nature that identifies the group B&M, responding with innovation to the needs of contemporary spaces in a compromise between design, product quality and the versatility of a daily and personal use.

FR

C'est un grand plaisir pour nous vous présenter le catalogue "Solutions de Bain" où vous trouverez une large gamme de solutions intégrées de bains que nous mettons à votre disposition à travers nos marques Ctesi® et Bellian®.

Cette édition reflète le caractère industriel en pleine croissance qui identifie le groupe B&M répondant avec innovation aux besoins des espaces contemporains sur un compromis sérieux entre le design, la qualité du produit et la polyvalence pour une usage personnalisé.

ES

Es con gran placer que presentamos nuestro catálogo "Soluciones de Baño", donde puede encontrar una amplia gama de productos de nuestras marcas Ctesi® y Bellian®.

Esta edición refleja la naturaleza cada vez más industrial que identifica el grupo B&M, respondiendo con innovación a las necesidades de los espacios contemporáneos en un compromiso entre el diseño, la calidad del producto y la versatilidad para el uso diario y personal.



Since 1997 we are implemented in the sanitaryware market, offering a wide range of integrated solutions for bathroom and plumbing systems with a strong commitment between the service, the quality and design of products marketed through our own brands:

In recent years the B&M group has consolidated its space in the market, investing in the design, development and production of the products that it sells. Thus, it is guaranteed control over the entire value chain always aiming to finding competitive solutions with a high level of quality.

Currently, B&M group consists in 4 industrial units that develop their activity in the production of sanitary ware, including bathroom furniture, shower enclosures, taps and bath accessories and a wide range of sanitary plastic items. In this way Barros & Moreira adds value from the design, development and marketing of a wide range of bathroom integrated solutions.

With an installed capacity to produce a wide range of standardized products, the company is still dedicated to the production of customized products tailored to each customer, in compliance with the rigorous standards of quality and service that identifies the group.

We are a team that combines the expertise of more than 50 years of our founders with the dynamism of a young and professional team committed to exceed your expectations.

Depuis 1997, nous sommes sur le marché des produits sanitaires, offrant une large gamme de solutions intégrées pour la salle de bains et des systèmes de plomberie avec un fort engagement du service, la qualité et le design des produits vendus vers nos marques:

Au cours des dernières années, le groupe B&M a consolidé sa place dans le marché, en se concentrant plus sur la conception, le développement et la production des produits vendus. Ainsi, le contrôle sur la chaîne de valeur ayant pour objectif principal la recherche de solutions compétitives avec un haut niveau de qualité est garanti.

Actuellement, le groupe B&M réunit 4 unités industrielles qui sont en activité dans la production d'articles sanitaires, y compris les meubles de salle de bain, cabines de douche, robinets et accessoires de bain et une large gamme d'articles sanitaires en plastique. Ainsi, Barros & Moreira ajoute de la valeur à partir de la conception, développement et la commercialisation d'une large gamme de solutions intégrées pour la salle de bains.

Avec une capacité installée pour produire une large gamme de produits standardisés, la société est toujours dédiée à la production de produits personnalisés pour répondre à chaque client, en conformité avec les normes rigoureuses de qualité et de service qui identifient le groupe.

Nous sommes une équipe qui allie l'expertise de plus de 50 ans de nos fondateurs avec le dynamisme d'une équipe jeune et professionnelle engagée à dépasser vos attentes.

Desde 1997 estamos implementados en el mercado de sanitarios, ofreciendo una amplia gama de soluciones integradas para el cuarto de baño y sistemas de plomería con un fuerte compromiso entre el servicio, la calidad y el diseño de los productos comercializados a través de nuestras propias marcas:

En los últimos años el grupo B & M ha consolidado su espacio en el mercado invirtiendo en el diseño, desarrollo y producción de los productos que vende. Por lo tanto, el control es garantizado en toda la cadena de valor siempre con el objetivo de encontrar soluciones competitivas con un alto nivel de calidad.

Actualmente, el grupo B&M consiste en 4 unidades industriales que desarrollan su actividad en la producción de artículos sanitarios, incluyendo muebles de baño, cabinas de ducha, grifos y accesorios de baño y una amplia gama de artículos de plástico sanitarios. De este modo Barros & Moreira añade valor a partir del diseño, desarrollo y comercialización de una amplia gama integrada de soluciones de baño.

Con una capacidad instalada para producir una amplia gama de productos estandarizados, la compañía aún está dedicada a la producción de productos personalizados a la medida de cada cliente, de acuerdo con los rigurosos estándares de calidad y servicio que identifican el grupo.

Somos un equipo que combina la experiencia de más de 50 años de nuestros fundadores con el dinamismo de un equipo joven y profesional comprometido a superar sus expectativas.



Taps and Accessories
Robinetterie et Accessoires
Grifería y accesorios



Plumbing fittings
Accessoires de plomberie
Accesorios de fontanería



bellian®

Furniture, Sanitaryware and Shower Enclosures
Meubles, Appareils Sanitaires et Cabines de Douche
Muebles, cerámica sanitaria y Mamparas de Baño

BMK®

Sanitary Plastics
Plastiques Sanitaires
Plásticos Sanitarios



 **LARGE CLICK CLACK WASTE VALVE**
VIDAGE CLICK CLACK GRAND
 DESAGÜE QUICK-CLAC GRANDE

 **SQUARE CLICK CLACK WASTE VALVE**
VIDAGE CLICK CLACK CARRÉ
 DESAGÜE QUICK-CLAC CUADRADA

 **CLICK CLACK WASTE VALVE**
VIDAGE CLICK CLACK
 DESAGÜE QUICK-CLAC

 **AUTOMATIC WASTE VALVE**
VIDAGE AUTOMATIQUE
 DESAGÜE AUTOMÁTICO

 **SELF CLOSING TAPS**
TEMPORISÉES
 TEMPORIZADAS

 **ELECTRONIC TAPS**
ROBINETS ÉLECTRONIQUES
 GRIFERÍA ELECTRÓNICA

 **PROVIDED IN BOX**
FOURNIT EN BOÎTE
 SUMINISTRA EN CAJA

 **PAPER SHEETS CAPACITY**
CAPACITÉ FEUILLES DE PAPIER
 CAPACIDAD EN HOJAS DE PAPEL

 **PAPER ROLL CAPACITY**
CAPACITÉ ROULEAU DE PAPIER
 CAPACIDAD DE ROLLO DE PAPEL

 **LITRES CAPACITY**
CAPACITÉ EN LITRES
 CAPACIDAD EN LITROS

 **KG CAPACITY**
CAPACITÉ EN KG
 CAPACIDAD EN KG

 **DESCRIPTION OF BATTERIES**
DESCRIPTION DES BATTERIES
 DESCRIPCIÓN DE LAS PILAS

 **ELECTRICAL OUTLET**
PRISE ÉLECTRIQUE
 ENCHUFE ELÉCTRICO

 **VOLTAGE ELECTRICAL**
TENSION ÉLECTRIQUE
 VOLTAJE ELÉCTRICO

 **THERMOSTATIC TAPS**
ROBINETS THERMOSTATIQUES
 GRIFERÍA TERMOSTÁTICA

 **CARTRIDGES ECO SAFE**
CARTOUCHES ECO SAFE
 CARTUCHOS ECO SAFE

 **HANDLE 1/4 TOUR**
POIGNÉE 1/4 TOUR
 MONTURA 1/4 VUELTA

 **SOFT OPENING**
OUVERTURE DOUX
 APERTURA SUAVE

 **RECLINING HIGH SPOUT**
BEC HAUT BASCULANT
 CAÑO ALTO ABATIBLE

 **ANTI-TWIST SYSTEM**
SYSTÈME ANTI-TORSION
 SISTEMA ANTI-TWIST

 **STAINLESS STEEL AISI 304**
ACIER INOXYDABLE AISI 304
 ACERO INOXIDABLE AISI 304



 **BASE UNIT DEPTH**
PROFONDEUR MEUBLE
 PROFUNDIDAD DEL MUEBLE

 **SUSPENDED BASE UNIT**
MEUBLE SUSPENDU
 MUEBLE SUSPENDIDO

 **BASE UNIT WITH FEET**
MEUBLE AVEC PIEDS
 MUEBLE CON PATAS

 **MODULAR COMPOSITIONS**
COMPOSITIONS MODULAIRES
 COMPOSICIONES MODULARES

 **COSTUM SIZES**
DIMENSIONS PERSONNALISÉES
 MUEBLE A LA MEDIDA

 **CLICK OPENING SYSTEM**
SYSTÈME D'OUVERTURE CLIC
 APERTURA CLIC

 **INTERNAL DRAWER**
TIROIR INTÉRIEUR
 CAJÓN INTERIOR

 **SOFT CLOSE DRAWER SYSTEM**
TIROIR AVEC SYSTÈME SOFT CLOSE
 CAJÓN CON CIERRE SUAVE

 **SOFT CLOSE DOOR SYSTEM**
PORTE AVEC SYSTÈME SOFT CLOSE
 PUERTA CON CIERRE SUAVE

 **LACQUERED RAL COLOURS**
COULEURS RAL LAQUÉS
 COLORES RAL LACADOS

 **LACQUERED BELLIAN COLOURS**
COULEURS BELLIAN LAQUÉS
 COLORES BELLIAN LACADOS

 **THERMOLAMINATE**
TERMOLAMINÉ
 TERMOLAMINADOS

 **WOOD TEXTURES**
BOIS TEXTURES
 TEXTURAS MADERAS

 **WOODS**
BOIS
 MADERAS

 **COMPLAIN CE DIRECTIVES**
CONFORMÉMENT AUX DIRECTIVES
 DECLARACIÓN CE DE CONFORMIDAD

 **ENERGY SAVER**
ÉCONOMISEUR D'ÉNERGIE
 AHORRADOR DE ENERGÍA

 **MODEL CLASSES (I, II, III)**
CLASSES DU MODÈLE (I, II, III)
 CLASE DE EFICIENCIA ENERGÉTICA (I, II, III)

 **LEDS TIPS**
BANDE LEDS
 TIRA DE LEDS

 **IP DEGREE PROTECTION**
INDICE DE PROTECTION IP
 FACTOR DE PROTECCIÓN

 **FLUORESCENT LIGHT**
TUBE FLUORESCENT
 LÁMPARA FLUORESCENTE

 **LIGHT E14**
LUMIÈRE E14
 LUZ E14

 **EFFICIENT MODEL**
MODÈLE EFFICIENT
 MODELO EFICIENTE

 **LIGHT DIRECTION**
DIRECTION DE LA LUMIÈRE
 DIRECCIÓN DE LA LUZ

 **REVERSIBLE**
REVERSIBLE
 REVERSIBLE

 **MULTI FITTING SUPPORT**
SUPPORT MULTI-FIXATION
 APOYO MULTI-FIJACIÓN

 **SQUARE SHOWER TRAYS**
RECEVEURS DE DOUCHE CARRÉ
 PLATO DE DUCHA CUADRADA

 **RECTANGULAR SHOWER TRAYS**
RECEVEURS DE DOUCHE RECTANGULAIRE
 PLATO DE DUCHA RECTANGULAR

 **ROUND SHOWER TRAYS**
RECEVEURS DE DOUCHE ROND
 PLATO DE DUCHA CIRCULAR

 **GLASS**
VÉRRE
 VIDRIO

 **ACRYLIC**
ACRYLIQUE
 ACRÍLICO

 **PVC**
 PVC

 **MAGNETIC LOCK**
FERMETURE MAGNÉTIQUE
 CIERRE MAGNÉTICO

 **REVERSIBLE**
REVERSIBLE
 REVERSIBLE

 **FIXED SHOWER**
DOUCHE FIXE
 ROCIADOR

 **MASSAGE JETS**
JETS DE MASSAGE
 JETS DE MASSAGE

 **HAND SHOWER**
DOUCHE À MAIN
 DUCHA DE MANO

 **SINGLE LEVER MIXER**
MITIGEUR
 MONOMANDO



- 006 Taps // Robinets // Grifería**
Taps for bathroom spaces
 Robinets pour espaces de bains
 Grifos para espacios de baño
- 027 Cozi Series**
Taps for kitchen
 Robinets pour la cuisine
 Grifos para cocina
- 032 Shower Systems**
Built-in shower system
 Systèmes de douche intégré
 Sistemas de ducha incorporada
- 048 Bath Series**
Towel rails and bath accessories
 Porte-serviettes et accessoires de bain
 Toalleros y accesorios de baño
- 054 Hotel Series**
Towel rails and accessories for hotels
 Porte-serviettes et accessoires pour les hôtels
 Toalleros y accesorios para hoteles
- 055 Clean&Safe Series**
Solutions for public spaces and reduced mobility
 Solutions pour les espaces publics et à mobilité réduite
 Las soluciones para espacios públicos y con movilidad reducida
- 059 Technical & Clinic Series**
Taps for public spaces, hospitals, self closing and electronic taps
 Robinets pour espaces publics, hôpitaux, temporisées et robinets électroniques
 Grifería para espacios públicos, hospitalares, temporizada y electrónica

bellan

BATHROOM FURNITURE // MEUBLES DE SALLE DE BAIN // MUEBLES DE BAÑO

- 064 Bathroom Furniture // Meubles de Salle de Bain // Muebles de Baño**
Furniture solutions for bathroom space
 Solutions de meubles pour l'espace salle de bain
 Soluciones de mobiliario para el espacio de baño
- 146 Reflex Collection**
Mirrors & Light Fixtures // Mirrors & Appliques // Espejos & Apliques
- 154 Ice Collection**
Washbasins // Vasques // Lavabos

bellan

SHOWER ENCLOSURES AND HYDROMASSAGE

CABINES DE DOUCHE ET HYDROMASSAGE // MAMPARAS DE DOUCHA Y HIDROMASSAJE

- 160 Shower Enclosures // Cabines de Douche // Mamparas de Doucha**
Glass // Verre // Vidrio
- 162 Bath Enclosures // Parois de Bain // Mamparas de Baño**
Glass // Verre // Vidrio
- 214 Shower Drains // Caniveaux de Douche // Canaletas de Doucha**
Concealed solutions for free access to the shower
 Solutions encastrés pour le libre accès à la douche
 Soluciones empotradas para el libre acceso a la ducha
- 216 Shower Trays // Receveurs de Douche // Platos de Doucha**
Acrylic // Acrylique // Acrílico
- Bath & Hydro. Systems**
221 Bain & Systèmes d'Hydro. // Baño & Sistemas de Hidro.
Bathub // Baignoire // Bañera
- 225 Hydromassage // Hydromassage // Hidromasaje**
Hydromassage Columns // Columns de Hydromassage // Columnas de Hidromasaje

bellan

SANITARY WARE // APPAREILS SANITAIRES // SANITARIOS

- 230 Sanitary Ware // Appareils Sanitaires // Sanitarios**
Sanitary ceramic sets
 Ensembles céramiques sanitaires
 Conjuntos sanitarios de cerámica
- 237 Handicapped**
Sanitary ceramics for people with reduced mobility
 Céramique sanitaire pour handicapés
 Sanitarios de cerámica para personas con movilidad reducida
- 239 Internal Cisterns // Réservoirs Intérieures // Cisternas Empotradas**
Interior cisterns installation systems and control panels
 Systèmes d'installation réservoirs intérieures et les panneaux de contrôle
 Sistemas de instalación de cisternas empotradas y paneles de control

- 244 General Conditions // Conditions Générales // Condiciones Generales**



Water is a precious resource, the source of life, and symbol of purity in liquid form.

We embody water, and want to enjoy this important resource by your side, enhancing your well-being and contributing to the sustainability of our planet.

This is our passion, we create innovative concepts giving you the perfect starting point to create inspiring environments.

L'eau est un bien précieux, source de vie qui symbolise la pureté dans son état liquide.

Nous sommes de l'eau, nous voulons profiter de cette importante ressource à votre côté en améliorant votre bien-être et en contribuant à la durabilité de notre planète.

C'est notre passion, nous créons des concepts innovants, avec nous créez de nouveaux environnements, de nouvelles sensations.

El agua es una valiosa fuente de vida que simboliza la pureza en su estado líquido. Somos agua, queremos disfrutar de este importante recurso a su lado, mejorando su bienestar y contribuyendo a la sostenibilidad de nuestro planeta.



Ctesi® wins Gold and Silver at the world's largest design competition

Ctesi® remporte l'Or et l'Argent à la plus grande compétition de design du monde
Ctesi® gana el oro y plata en la competición de diseño más grande del mundo

Smooth's design has been honored with the Silver A'Design Award while the Straw model was awarded the famous Gold A'Design Award in the bathroom furniture and sanitary ware category, an international competition which aims to highlight the best design oriented products and concepts of excellence in the fields of art, design and architecture.

In this contest, involving more than 12,000 competitors worldwide, the Portuguese design of Ctesi® taps were recognized by a diversified international jury which annually awards the most sublime designs.

Le design du robinet Smooth a reçu le Silver A'Design Award tandis que le modèle Straw a reçu le Gold A'Design Award dans la catégorie de meubles de salle de bains et sanitaires de la compétition internationale A'Design Awards qui vise à mettre en évidence les meilleurs produits orientés par le design et les concepts d'excellence dans le domaine de l'art, du design et de l'architecture.

Dans ce concours, qui a été suivi par plus de 12 000 concurrents à travers le monde, le design portugais des robinets Ctesi® a été reconnu par un jury international diversifié qui souligne chaque année les designs les plus sublimes.

El diseño del grifo Smooth fue galardonado con el Premio de Plata, mientras que el modelo Straw fue galardonado con el Premio de Oro en la categoría de muebles de baño y sanitarios de la competición A'Design Awards que tiene como objetivo destacar los mejores productos de orientación al diseño y conceptos de excelencia en el campo del arte, del diseño y de la arquitectura.

En esta competición, con más de 12.000 competidores a nivel mundial, el diseño portugués de los grifos Ctesi® fue reconocido por un jurado internacional diverso que anualmente destaca los diseños más sublimes.

**We
are
water
proof**



STRAW

24 CARAT GOLD-PLATED

24 CARATS PLAQUÉ OR

BAÑO DE ORO DE 24 QUILATES





Awarded with a Golden A'Design Award, Straw's design is inspired by the tubular forms of the young and fun straws that accompany a refreshing drink in the summer or a hot drink in the winter. With this project we intended to create an object of contemporary dashing and simultaneously fun design.

Gagnant d'un Gold A'Design Award, le design de Straw est inspiré dans les formes tubulaires des pailles jeunes et amusantes qui accompagnent une boisson rafraîchissante en été ou une boisson chaude en hiver. Avec ce projet, nous avons l'intention de créer un objet contemporain avec un design fringant et simultanément amusant.

Galardonado con un Golden A'Design Award, el diseño del grifo Straw inspirase en las formas tubulares, jóvenes y divertidas de las pajitas que acompañan una bebida refrescante en verano o una bebida caliente en invierno. Un objeto de diseño contemporáneo audaz, pero a la vez divertido que sorprende por su simetría asimétrica.



SINGLE LEVER MIXER // MITIGEUR // MEZCLADOR
TALL BASIN // LAVABO HAUT // LAVABO ALTO

WITH WASTE VALVE - CHROME
AVEC VIDAGE - CHROMÉ
CON DESAGÜE - CROMADO

WITH WASTE VALVE - GOLD
AVEC VIDAGE - OR
CON DESAGÜE - ORO



SINGLE LEVER MIXER // MITIGEUR // MEZCLADOR
BASIN // LAVABO // LAVABO

WITH WASTE VALVE - CHROME
AVEC VIDAGE - CHROMÉ
CON DESAGÜE - CROMADO

WITH WASTE VALVE - GOLD
AVEC VIDAGE - OR
CON DESAGÜE - ORO



SINGLE LEVER MIXER // MITIGEUR // MEZCLADOR
BIDET // BIDET // BIDÉ

WITH WASTE VALVE - CHROME
AVEC VIDAGE - CHROMÉ
CON DESAGÜE - CROMADO

WITH WASTE VALVE - GOLD
AVEC VIDAGE - OR
CON DESAGÜE - ORO



SINGLE LEVER MIXER // MITIGEUR // MEZCLADOR
BATH // BAIGNOIRE // BAÑERA

BRASS KIT + GIRAFLEX SHOWER HOSE - CHROME
KIT LAITON + FLEXIBLE DE DOUCHE GIRAFLEX - CHROMÉ
SET LATÓN + FLEXIBLE GIRAFLEX - CROMADO

BRASS KIT + SHOWER HOSE - GOLD
KIT LAITON + FLEXIBLE DE DOUCHE - OR
SET LATÓN + FLEXIBLE - ORO



SINGLE LEVER MIXER // MITIGEUR // MEZCLADOR
SHOWER // DOUCHE // DUCHA

BRASS KIT + GIRAFLEX SHOWER HOSE - CHROME
KIT LAITON + FLEXIBLE DE DOUCHE GIRAFLEX - CHROMÉ
SET LATÓN + FLEXIBLE GIRAFLEX - CROMADO

BRASS KIT + SHOWER HOSE - GOLD
KIT LAITON + FLEXIBLE DE DOUCHE - OR
SET LATÓN + FLEXIBLE - ORO



COMPLETE YOUR CHOICE WITH THE STRAW ACCESSORIES ON PAGE 48.
COMPLÉTEZ VOTRE CHOIX AVEC LA GAMME D'ACCESSOIRES STRAW À LA PAGE 48.
COMPLETE SU ELECCIÓN CON LA GAMA DE ACCESORIOS STRAW EN LA PÁG. 48.





Smooth's design, awarded with a Silver A'Design Award, in the largest international design competition, is inspired by clear and crystal forms like the water it pours. With this project we wanted to create an object, which clearly assumed cylindrical and symmetrical shapes. The design is based on the purest form of a cylinder, where the water flows naturally from its source to the user in the fewest steps possible.

Le design du robinet de lavabo Smooth, gagnant d'un Silver A'Design Award, plus grand compétition de design du monde, est inspiré dans les formes claires et cristallines, comme l'eau qui s'écoule de lui-même. Avec ce projet, nous créons un objet de design, où les formes cylindriques et symétriques sont clairement assumés. Le design est basée sur la forme pure d'un cylindre, résultant en un robinet qui est le prolongement naturel du tube où l'eau circule jusqu'à ce qu'elle atteigne l'utilisateur.

El diseño del grifo Smooth se inspirase en formas limpias y cristalinas como el agua que de ello corre. Con este proyecto creamos un objeto de diseño donde las formas simétricas y cilíndricas están claramente asumidas. El diseño se basa en la forma pura de un cilindro, haciendo que el grifo sea una extensión natural de la tubería donde el agua fluye hacia el contacto con el usuario.



SINGLE LEVER MIXER // MITIGEUR // MEZCLADOR
TALL BASIN // LAVABO HAUT // LAVABO ALTO

WITH WASTE VALVE - CHROME
AVEC VIDAGE - CHROMÉ
CON DESAGÜE - CROMADO



SINGLE LEVER MIXER // MITIGEUR // MEZCLADOR
BASIN // LAVABO // LAVABO

WITH WASTE VALVE - CHROME
AVEC VIDAGE - CHROMÉ
CON DESAGÜE - CROMADO



SINGLE LEVER MIXER // MITIGEUR // MEZCLADOR
BIDET // BIDET // BIDÉ

WITH WASTE VALVE - CHROME
AVEC VIDAGE - CHROMÉ
CON DESAGÜE - CROMADO



COMPLETE YOUR CHOICE WITH THE SMOOTH ACCERORIES ON PAGE 48.
COMPLÉTEZ VOTRE CHOIX AVEC LA GAMME D'ACCESSOIRES SMOOTH À LA PAGE 48.
COMPLETE SU ELECCIÓN CON LA GAMA DE DE ACCESORIOS SMOOTH EN LA PÁG. 48.

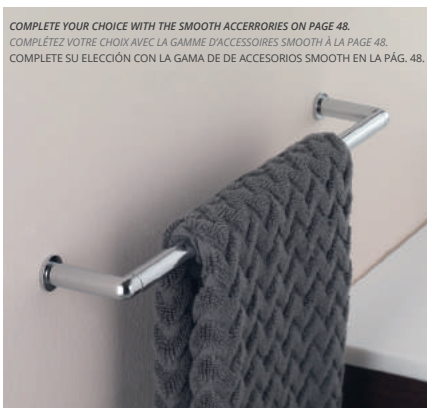

SINGLE LEVER MIXER // MITIGEUR // MEZCLADOR
BATH // BAIGNOIRE // BAÑERA

BRASS KIT + GIRAFLEX SHOWER HOSE
KIT LAITON + FLEXIBLE DE DOUCHE GIRAFLEX
SET LATÓN + FLEXIBLE GIRAFLEX



SINGLE LEVER MIXER // MITIGEUR // MEZCLADOR
SHOWER // DOUCHE // DUCHA

BRASS KIT + GIRAFLEX SHOWER HOSE
KIT LAITON + FLEXIBLE DE DOUCHE GIRAFLEX
SET LATÓN + FLEXIBLE GIRAFLEX



FACE

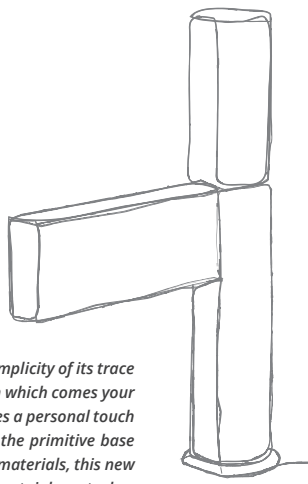

The new tap born of a simple and robust line. The simplicity of its trace surprise by how reconciles the cylindrical lines from which comes your body and won personality by the flat face which gives a personal touch and unique communicating with the user through the primitive base and simultaneously intuitive and functional. As for materials, this new Ctesi® tap is available in brass with chrome finish or stainless steel.

Le nouveau robinet est né d'une ligne simple et robuste. La simplicité de sa ligne surprend par la façon dont concilie les lignes cylindriques où vient le corps et gagne personnalité par la face plate qui donne une touche personnelle et unique en communiquant avec l'utilisateur à travers de la base primitive et simultanément intuitive et fonctionnelle. En ce qui concerne les matériaux, ce nouveau robinet Ctesi® est disponible en laiton chromé ou en acier inoxydable.

El nuevo grifo nace de una línea sencilla y robusta. La simplicidad de su traza sorpresa por la forma en que concilia las líneas cilíndricas dónde viene su cuerpo y gana personalidad con la cara plana que le da un toque personal y único al comunicarse con el usuario a través de la base primitiva ya la vez intuitiva y funcional. En cuanto a los materiales, este nuevo grifo Ctesi® está disponible en latón con acabado cromado o acero inoxidable.



COMPLETE YOUR CHOICE WITH THE FACE ACCESSORIES ON PAGE 49.
COMPLÉTEZ VOTRE CHOIX AVEC LA GAMME D'ACCESSOIRES FACE À LA PAGE 49.
COMPLETE SU ELECCIÓN CON LA GAMA DE ACCESORIOS FACE EN LA PÁG. 49.



SINGLE LEVER MIXER // MITIGEUR // MEZCLADOR
TALL BASIN // LAVABO HAUT // LAVABO ALTO

SIMPLE - CHROME
SIMPLE - CHROMÉ
SIMPLE - CROMADO

WITH WASTE VALVE - CHROME
AVEC VIDAGE - CHROMÉ
CON DESAGÜE - CROMADO

SIMPLE - STAINLESS STEEL
SIMPLE - ACIER INOXYDABLE
SIMPLE - ACERO INOXIDABLE

WITH WASTE VALVE - STAINLESS STEEL
AVEC VIDAGE - ACIER INOXYDABLE
CON DESAGÜE - ACERO INOXIDABLE



SINGLE LEVER MIXER // MITIGEUR // MEZCLADOR
BASIN // LAVABO // LAVABO

SIMPLE - CHROME
SIMPLE - CHROMÉ
SIMPLE - CROMADO

WITH WASTE VALVE - CHROME
AVEC VIDAGE - CHROMÉ
CON DESAGÜE - CROMADO

SIMPLE - STAINLESS STEEL
SIMPLE - ACIER INOXYDABLE
SIMPLE - ACERO INOXIDABLE

WITH WASTE VALVE - STAINLESS STEEL
AVEC VIDAGE - ACIER INOXYDABLE
CON DESAGÜE - ACERO INOXIDABLE



SINGLE LEVER MIXER // MITIGEUR // MEZCLADOR
BIDET // BIDET // BIDÉ

SIMPLE - CHROME
SIMPLE - CHROMÉ
SIMPLE - CROMADO

WITH WASTE VALVE - CHROME
AVEC VIDAGE - CHROMÉ
CON DESAGÜE - CROMADO

SIMPLE - STAINLESS STEEL
SIMPLE - ACIER INOXYDABLE
SIMPLE - ACERO INOXIDABLE

WITH WASTE VALVE - STAINLESS STEEL
AVEC VIDAGE - ACIER INOXYDABLE
CON DESAGÜE - ACERO INOXIDABLE



SINGLE LEVER MIXER // MITIGEUR // MEZCLADOR
BUILT-IN BASIN // LAVABO À ENCASTRER
EMPOTRABLE LAVABO

SIMPLE
SIMPLE
SIMPLE

WITH WASTE VALVE - CHROME
AVEC VIDAGE - CHROMÉ
CON DESAGÜE - CROMADO



SINGLE LEVER MIXER // MITIGEUR // MEZCLADOR
BATH // BAIGNOIRE // BAÑERA

ABS ACCESSORIES + GIRAFLEX SHOWER HOSE
KIT ACCESSOIRES ABS + FLEXIBLE DE DOUCHE GIRAFLEX
SET ACCESORIOS EN ABS + FLEXIBLE GIRAFLEX

BRASS KIT ACCESSORIES + GIRAFLEX SHOWER HOSE
KIT ACCESSOIRES LAITON + FLEXIBLE DE DOUCHE GIRAFLEX
SET ACCESORIOS EN LATÓN + FLEXIBLE GIRAFLEX

STAINLESS STEEL KIT ACCESSORIES + GIRAFLEX SHOWER HOSE
KIT ACCESS. ACIER INOXYDABLE + FLEXIBLE DE DOUCHE GIRAFLEX
SET ACCESORIOS EN ACERO INOXIDABLE + FLEXIBLE GIRAFLEX



SINGLE LEVER MIXER // MITIGEUR // MEZCLADOR
SHOWER // DOUCHE // DUCHA

ABS ACCESSORIES + GIRAFLEX SHOWER HOSE
KIT ACCESSOIRES ABS + FLEXIBLE DE DOUCHE GIRAFLEX
SET ACCESORIOS EN ABS + FLEXIBLE GIRAFLEX

BRASS KIT ACCESSORIES + GIRAFLEX SHOWER HOSE
KIT ACCESSOIRES LAITON + FLEXIBLE DE DOUCHE GIRAFLEX
SET ACCESORIOS EN LATÓN + FLEXIBLE GIRAFLEX

STAINLESS STEEL KIT ACCESSORIES + GIRAFLEX SHOWER HOSE
KIT ACCESS. ACIER INOXYDABLE + FLEXIBLE DE DOUCHE GIRAFLEX
SET ACCESORIOS EN ACERO INOXIDABLE + FLEXIBLE GIRAFLEX

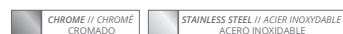



SINGLE LEVER MIXER // MITIGEUR // MEZCLADOR
BASIN // HAUT // LAVABO

SIMPLE
SIMPLE
SIMPLE

WITH WASTE VALVE - CHROME
AVEC VIDAGE - CHROMÉ
CON DESAGÜE - CROMADO



SINGLE LEVER MIXER // MITIGEUR // MEZCLADOR
BIDET // BIDET // BIDÉ

SIMPLE
SIMPLE
SIMPLE

WITH WASTE VALVE - CHROME
AVEC VIDAGE - CHROMÉ
CON DESAGÜE - CROMADO



SINGLE LEVER MIXER // MITIGEUR // MEZCLADOR
TALL BASIN // LAVABO HAUT // LAVABO ALTO

SPOUT 147 MM
BEC 147 MM
CAÑO 147 MM

SIMPLE
SIMPLE
SIMPLE

SPOUT 147 MM
BEC 147 MM
CAÑO 147 MM

WITH WASTE VALVE - CHROME
AVEC VIDAGE - CHROMÉ
CON DESAGÜE - CROMADO

SPOUT 200 MM
BEC 200MM
CAÑO 200 MM

SIMPLE
SIMPLE
SIMPLE

SPOUT 200 MM
BEC 200MM
CAÑO 200 MM

WITH WASTE VALVE - CHROME
AVEC VIDAGE - CHROMÉ
CON DESAGÜE - CROMADO



SINGLE LEVER MIXER // MITIGEUR // MEZCLADOR
BUILT-IN BASIN // LAVABO À ENCASTRER
EMPOTRABLE LAVABO

SIMPLE
SIMPLE
SIMPLE

WITH WASTE VALVE - CHROME
AVEC VIDAGE - CHROMÉ
CON DESAGÜE - CROMADO



SINGLE LEVER MIXER // MITIGEUR // MEZCLADOR
BATH // BAIGNOIRE // BAÑERA

BRASS KIT ACCESSORIES + GIRAFLEX SHOWER HOSE
KIT ACCESSOIRES LAITON + FLEXIBLE DE DOUCHE GIRAFLEX
SET ACCESORIOS EN LATÓN + FLEXIBLE GIRAFLEX

ABS KIT ACCESSORIES + GIRAFLEX SHOWER HOSE
KIT ACCESSOIRES ABS + FLEXIBLE DE DOUCHE GIRAFLEX
SET ACCESORIOS EN ABS + FLEXIBLE GIRAFLEX



THERMOSTATIC MIXER // MITIGEUR THERMOSTATIC
MEZCLADOR TERMOSTÁTICO
BATH // BAIGNOIRE // BAÑERA

BRASS KIT ACCESSORIES + GIRAFLEX SHOWER HOSE
KIT ACCESSOIRES LAITON + FLEXIBLE DE DOUCHE GIRAFLEX
SET ACCESORIOS EN LATÓN + FLEXIBLE GIRAFLEX

ABS KIT ACCESSORIES + GIRAFLEX SHOWER HOSE
KIT ACCESSOIRES ABS + FLEXIBLE DE DOUCHE GIRAFLEX
SET ACCESORIOS EN ABS + FLEXIBLE GIRAFLEX



SINGLE LEVER MIXER // MITIGEUR // MEZCLADOR
SHOWER // DOUCHE // DUCHA

BRASS KIT ACCESSORIES + GIRAFLEX SHOWER HOSE
KIT ACCESSOIRES LAITON + FLEXIBLE DE DOUCHE GIRAFLEX
SET ACCESORIOS EN LATÓN + FLEXIBLE GIRAFLEX

ABS KIT ACCESSORIES + GIRAFLEX SHOWER HOSE
KIT ACCESSOIRES ABS + FLEXIBLE DE DOUCHE GIRAFLEX
SET ACCESORIOS EN ABS + FLEXIBLE GIRAFLEX



THERMOSTATIC MIXER // MITIGEUR THERMOSTATIC
MEZCLADOR TERMOSTÁTICO
SHOWER // DOUCHE // DUCHA

BRASS KIT ACCESSORIES + GIRAFLEX SHOWER HOSE
KIT ACCESSOIRES LAITON + FLEXIBLE DE DOUCHE GIRAFLEX
SET ACCESORIOS EN LATÓN + FLEXIBLE GIRAFLEX

ABS KIT ACCESSORIES + GIRAFLEX SHOWER HOSE
KIT ACCESSOIRES ABS + FLEXIBLE DE DOUCHE GIRAFLEX
SET ACCESORIOS EN ABS + FLEXIBLE GIRAFLEX



COLUMN // COLONNE // COLUMNA
SHOWER // DOUCHE // DUCHA

THERMOSTATIC MIX. W/ BRASS SHOWERS
MIT. THERMOSTATIC A/ DOUCHETTE LAITON
MEZ. TERMOSTÁTICO C/ DUCHAS DE LATÓN



THERMOSTATIC MIX. W/ ABS SHOWERS
MIT. THERMOSTATIC A/ DOUCHETTE ABS
MEZ. TERMOSTÁTICO C/ DUCHAS EN ABS



SINGLE LEVER MIXER W/ BRASS SHOWERS
MITIGEUR A/ DOUCHETTE LAITON
MEZCLADOR C/ DUCHAS DE LATÓN

SINGLE LEVER MIXER W/ ABS SHOWERS
MITIGEUR A/ DOUCHETTE ABS
MEZCLADOR C/ DUCHAS EN ABS





SINGLE LEVER MIXER // MITIGEUR // MEZCLADOR
TALL BASIN // LAVABO HAUT // LAVABO ALTO

SPOUT 135 MM
BEC 135 MM
CAÑO 135 MM

SIMPLE
SIMPLE
SIMPLE

SPOUT 135 MM
BEC 135 MM
CAÑO 135 MM

WITH WASTE VALVE
AVEC VIDAGE
CON DESAGÜE

SPOUT 200 MM
BEC 200MM
CAÑO 200 MM

SIMPLE
SIMPLE
SIMPLE

SPOUT 200 MM
BEC 200MM
CAÑO 200 MM

WITH WASTE VALVE
AVEC VIDAGE
CON DESAGÜE



SINGLE LEVER MIXER // MITIGEUR // MEZCLADOR
BUILT-IN BASIN // LAVABO À ENCASTRER
EMPOTRABLE LAVABO

SIMPLE
SIMPLE
SIMPLE

WITH WASTE VALVE
AVEC VIDAGE
CON DESAGÜE



SINGLE LEVER MIXER // MITIGEUR // MEZCLADOR
BASIN // HAUT // LAVABO

SIMPLE
SIMPLE
SIMPLE

WITH WASTE VALVE
AVEC VIDAGE
CON DESAGÜE



SINGLE LEVER MIXER // MITIGEUR // MEZCLADOR
BIDET // BIDET // BIDÉ

SIMPLE
SIMPLE
SIMPLE

WITH WASTE VALVE
AVEC VIDAGE
CON DESAGÜE



SINGLE LEVER MIXER // MITIGEUR // MEZCLADOR
BATH // BAIGNOIRE // BAÑERA

BRASS KIT ACCESSORIES + GIRAFLEX SHOWER HOSE
KIT ACCESSOIRES LAITON + FLEXIBLE DE DOUCHE GIRAFLEX
SET ACCESORIOS EN LATÓN + FLEXIBLE GIRAFLEX

ABS KIT ACCESSORIES + GIRAFLEX SHOWER HOSE
KIT ACCESSOIRES ABS + FLEXIBLE DE DOUCHE GIRAFLEX
SET ACCESORIOS EN ABS + FLEXIBLE GIRAFLEX



SINGLE LEVER MIXER // MITIGEUR // MEZCLADOR
SHOWER // DOUCHE // DUCHA

BRASS KIT ACCESSORIES + GIRAFLEX SHOWER HOSE
KIT ACCESSOIRES LAITON + FLEXIBLE DE DOUCHE GIRAFLEX
SET ACCESORIOS EN LATÓN + FLEXIBLE GIRAFLEX

ABS KIT ACCESSORIES + GIRAFLEX SHOWER HOSE
KIT ACCESSOIRES ABS + FLEXIBLE DE DOUCHE GIRAFLEX
SET ACCESORIOS EN ABS + FLEXIBLE GIRAFLEX



COLUMN // COLONNE // COLUMNA
SHOWER // DOUCHE // DUCHA

THERMOSTATIC MIX. W/ BRASS SHOWERS
MIT. THERMOSTATICO A/ DOUCHETTE LAITON
MEZ. THERMOSTÁTICO C/ DUCHAS DE LATÓN



THERMOSTATIC MIX. W/ ABS SHOWERS
MIT. THERMOSTATICO A/ DOUCHETTE ABS
MEZ. THERMOSTÁTICO C/ DUCHAS EN ABS



SINGLE LEVER MIXER W/ BRASS SHOWERS
MITIGEUR A/ DOUCHETTE LAITON
MEZCLADOR C/ DUCHAS DE LATÓN

SINGLE LEVER MIXER W/ ABS SHOWERS
MITIGEUR A/ DOUCHETTE ABS
MEZCLADOR C/ DUCHAS EN ABS





SINGLE LEVER MIXER // MITIGEUR // MEZCLADOR
BUILT-IN BASIN // LAVABO À ENCASTRER
EMPOTRABLE LAVABO

SIMPLE
SIMPLE
SIMPLE

WITH WASTE VALVE
AVEC VIDAGE
CON DESAGÜE



SINGLE LEVER MIXER // MITIGEUR // MEZCLADOR
TALL BASIN // LAVABO HAUT // LAVABO ALTO

SPOUT 142 MM
BEC 142 MM
CAÑO 142 MM

SIMPLE
SIMPLE
SIMPLE

SPOUT 142 MM
BEC 142 MM
CAÑO 142 MM

WITH WASTE VALVE
AVEC VIDAGE
CON DESAGÜE

SPOUT 200 MM
BEC 200 MM
CAÑO 200 MM

SIMPLE
SIMPLE
SIMPLE

SPOUT 200 MM
BEC 200 MM
CAÑO 200 MM

WITH WASTE VALVE
AVEC VIDAGE
CON DESAGÜE



extensible

COLUMN // COLONNE // COLUMNA
SHOWER // DOUCHE // DUCHA

THERMOSTATIC MIX. W/ BRASS SHOWERS
MIT. THERMOSTATIQUE A/ DOUCHETTE LAITON
MEZ. TERMOSTÁTICO C/ DUCHAS O DE LATÓN



THERMOSTATIC MIX. W/ ABS SHOWERS
MIT. THERMOSTATIQUE A/ DOUCHETTE ABS
MEZ. TERMOSTÁTICO C/ DUCHAS EN ABS



SINGLE LEVER MIXER W/ BRASS SHOWERS
MITIGEUR A/ DOUCHETTE LAITON
MEZCLADOR C/ DUCHAS DE LATÓN

SINGLE LEVER MIXER W/ ABS SHOWERS
MITIGEUR A/ DOUCHETTE ABS
MEZCLADOR C/ DUCHAS EN ABS

CHROME // CHROMÉ
CROMADO

ADJUSTABLE HEIGHT // RÉGLABLE EN
HAUTEUR // ALTURA AJUSTABLE



SINGLE LEVER MIXER // MITIGEUR // MEZCLADOR
BASIN // HAUT // LAVABO

SIMPLE
SIMPLE
SIMPLE

WITH WASTE VALVE
AVEC VIDAGE
CON DESAGÜE



SINGLE LEVER MIXER // MITIGEUR // MEZCLADOR
BIDET // BIDET // BIDÉ

SIMPLE
SIMPLE
SIMPLE

WITH WASTE VALVE
AVEC VIDAGE
CON DESAGÜE



SINGLE LEVER MIXER // MITIGEUR // MEZCLADOR
BATH // BAIGNOIRE // BAÑERA

BRASS KIT ACCESSORIES + GIRAFLEX SHOWER HOSE
KIT ACCESSOIRES LAITON + FLEXIBLE DE DOUCHE GIRAFLEX
SET ACCESORIOS EN LATÓN + FLEXIBLE GIRAFLEX

ABS KIT ACCESSORIES + GIRAFLEX SHOWER HOSE
KIT ACCESSOIRES ABS + FLEXIBLE DE DOUCHE GIRAFLEX
SET ACCESORIOS EN ABS + FLEXIBLE GIRAFLEX

CHROME // CHROMÉ
CROMADO



SINGLE LEVER MIXER // MITIGEUR // MEZCLADOR
SHOWER // DOUCHE // DUCHA

BRASS KIT ACCESSORIES + GIRAFLEX SHOWER HOSE
KIT ACCESSOIRES LAITON + FLEXIBLE DE DOUCHE GIRAFLEX
SET ACCESORIOS EN LATÓN + FLEXIBLE GIRAFLEX

ABS KIT ACCESSORIES + GIRAFLEX SHOWER HOSE
KIT ACCESSOIRES ABS + FLEXIBLE DE DOUCHE GIRAFLEX
SET ACCESORIOS EN ABS + FLEXIBLE GIRAFLEX

CHROME // CHROMÉ
CROMADO



SINGLE LEVER MIXER // MITIGEUR // MEZCLADOR
TALL BASIN // LAVABO HAUT // LAVABO ALTO

SPOUT 142 MM
BEC 142 MM
CAÑO 142 MM

SIMPLE
SIMPLE
SIMPLE

SPOUT 142 MM
BEC 142 MM
CAÑO 142 MM

WITH WASTE VALVE
AVEC VIDAGE
CON DESAGÜE

SPOUT 200 MM
BEC 200 MM
CAÑO 200 MM

SIMPLE
SIMPLE
SIMPLE

SPOUT 200 MM
BEC 200 MM
CAÑO 200 MM

WITH WASTE VALVE
AVEC VIDAGE
CON DESAGÜE



CHROME // CHROMÉ
CROMADO



SINGLE LEVER MIXER // MITIGEUR // MEZCLADOR
BASIN // HAUT // LAVABO

SIMPLE
SIMPLE
SIMPLE

WITH WASTE VALVE
AVEC VIDAGE
CON DESAGÜE



CHROME // CHROMÉ
CROMADO



SINGLE LEVER MIXER // MITIGEUR // MEZCLADOR
BATH // BAIGNOIRE // BAÑERA

BRASS KIT ACCESSORIES + GIRAFLEX SHOWER HOSE
KIT ACCESSOIRES LAITON + FLEXIBLE DE DOUCHE GIRAFLEX
SET ACCESORIOS EN LATÓN + FLEXIBLE GIRAFLEX

ABS KIT ACCESSORIES + GIRAFLEX SHOWER HOSE
KIT ACCESSOIRES ABS + FLEXIBLE DE DOUCHE GIRAFLEX
SET ACCESORIOS EN ABS + FLEXIBLE GIRAFLEX



CHROME // CHROMÉ
CROMADO



SINGLE LEVER MIXER // MITIGEUR // MEZCLADOR
BUILT-IN BASIN // LAVABO À ENCASTRER
EMPOTRABLE LAVABO

SIMPLE
SIMPLE
SIMPLE

WITH WASTE VALVE
AVEC VIDAGE
CON DESAGÜE



CHROME // CHROMÉ
CROMADO



SINGLE LEVER MIXER // MITIGEUR // MEZCLADOR
BIDET // BIDET // BIDÉ

SIMPLE
SIMPLE
SIMPLE

WITH WASTE VALVE
AVEC VIDAGE
CON DESAGÜE



CHROME // CHROMÉ
CROMADO



SINGLE LEVER MIXER // MITIGEUR // MEZCLADOR
SHOWER // DOUCHE // DUCHA

BRASS KIT ACCESSORIES + GIRAFLEX SHOWER HOSE
KIT ACCESSOIRES LAITON + FLEXIBLE DE DOUCHE GIRAFLEX
SET ACCESORIOS EN LATÓN + FLEXIBLE GIRAFLEX

ABS KIT ACCESSORIES + GIRAFLEX SHOWER HOSE
KIT ACCESSOIRES ABS + FLEXIBLE DE DOUCHE GIRAFLEX
SET ACCESORIOS EN ABS + FLEXIBLE GIRAFLEX



CHROME // CHROMÉ
CROMADO



extendible

COLUMN // COLONNE // COLUMNA
SHOWER // DOUCHE // DUCHA

THERMOSTATIC MIX. W/ BRASS SHOWERS
MIT. THERMOSTATIC A/ DOUCHETTE LAITON
MEZ. TERMOSTÁTICO C/ DUCHAS DE LATÓN

3200

THERMOSTATIC MIX. W/ ABS HAND SHOWERS
MIT. THERMOSTATIC A/ DOUCHETTE ABS
MEZ. TERMOSTÁTICO C/ DUCHAS EN ABS

3800

SINGLE LEVER MIXER W/ BRASS SHOWERS
MITIGEUR A/ DOUCHETTE LAITON
MEZCLADOR C/ DUCHAS DE LATÓN

SINGLE LEVER MIXER W/ ABS SHOWERS
MITIGEUR A/ DOUCHETTE ABS
MEZCLADOR C/ DUCHAS EN ABS



ADJUSTABLE HEIGHT // RÉGLABLE EN
HAUTEUR // ALTURA AJUSTABLE



SINGLE LEVER MIXER // MITIGEUR // MEZCLADOR
BUILT-IN BASIN // LAVABO À ENCASTRER
 EMPOTRABLE LAVABO

SIMPLE
 SIMPLE
 SIMPLE

WITH WASTE VALVE
 AVEC VIDAGE
 CON DESAGÜE



SINGLE LEVER MIXER // MITIGEUR // MEZCLADOR
TALL BASIN // LAVABO HAUT // LAVABO ALTO

SPOUT 132 MM
 BEC 132 MM
 CAÑO 132 MM

SIMPLE
 SIMPLE
 SIMPLE

SPOUT 132 MM
 BEC 132 MM
 CAÑO 132 MM

WITH WASTE VALVE
 AVEC VIDAGE
 CON DESAGÜE

SPOUT 200 MM
 BEC 200 MM
 CAÑO 200 MM

SIMPLE
 SIMPLE
 SIMPLE

SPOUT 200 MM
 BEC 200 MM
 CAÑO 200 MM

WITH WASTE VALVE
 AVEC VIDAGE
 CON DESAGÜE



COLUMN // COLONNE // COLUMNA
SHOWER // DOUCHE // DUCHA

THERMOSTATIC MIX. W/ BRASS SHOWERS
 MIT. THERMOSTATIC A/ DOUCHETTE LAITON
 MEZ. TERMOSTÁTICO C/ DUCHAS DE LATÓN



THERMOSTATIC MIX. W/ ABS SHOWERS
 MIT. THERMOSTATIC A/ DOUCHETTE ABS
 MEZ. TERMOSTÁTICO C/ DUCHAS EN ABS



SINGLE LEVER MIXER W/ BRASS SHOWERS
 MITIGEUR A/ DOUCHETTE LAITON
 MEZCLADOR C/ DUCHAS DE LATÓN

SINGLE LEVER MIXER W/ ABS SHOWERS
 MITIGEUR A/ DOUCHETTE ABS
 MEZCLADOR C/ DUCHAS EN ABS

CHROME // CHROME
 CROMADO

ADJUSTABLE HEIGHT // RÉGLABLE EN
 HAUTEUR // ALTURA AJUSTABLE



SINGLE LEVER MIXER // MITIGEUR // MEZCLADOR
BASIN // HAUT // LAVABO

SIMPLE
 SIMPLE
 SIMPLE

WITH WASTE VALVE
 AVEC VIDAGE
 CON DESAGÜE



SINGLE LEVER MIXER // MITIGEUR // MEZCLADOR
BIDET // BIDET // BIDÉ

SIMPLE
 SIMPLE
 SIMPLE

WITH WASTE VALVE
 AVEC VIDAGE
 CON DESAGÜE



SINGLE LEVER MIXER // MITIGEUR // MEZCLADOR
BATH // BAIGNOIRE // BAÑERA

BRASS KIT ACCESSORIES + GIRAFLEX SHOWER HOSE
 KIT ACCESSOIRES LAITON + FLEXIBLE DE DOUCHE GIRAFLEX
 SET ACCESORIOS EN LATÓN + FLEXIBLE GIRAFLEX

ABS KIT ACCESSORIES + GIRAFLEX SHOWER HOSE
 KIT ACCESSOIRES ABS + FLEXIBLE DE DOUCHE GIRAFLEX
 SET ACCESORIOS EN ABS + FLEXIBLE GIRAFLEX

CHROME // CHROME
 CROMADO



SINGLE LEVER MIXER // MITIGEUR // MEZCLADOR
SHOWER // DOUCHE // DUCHA

BRASS KIT ACCESSORIES + GIRAFLEX SHOWER HOSE
 KIT ACCESSOIRES LAITON + FLEXIBLE DE DOUCHE GIRAFLEX
 SET ACCESORIOS EN LATÓN + FLEXIBLE GIRAFLEX

ABS KIT ACCESSORIES + GIRAFLEX SHOWER HOSE
 KIT ACCESSOIRES ABS + FLEXIBLE DE DOUCHE GIRAFLEX
 SET ACCESORIOS EN ABS + FLEXIBLE GIRAFLEX

CHROME // CHROME
 CROMADO



SINGLE LEVER MIXER // MITIGEUR // MEZCLADOR
TALL BASIN // LAVABO HAUT // LAVABO ALTO

SPOUT 132 MM
BEC 132 MM
CAÑO 132 MM

SIMPLE
SIMPLE
SIMPLE

SPOUT 132 MM
BEC 132 MM
CAÑO 132 MM

WITH WASTE VALVE
AVEC VIDAGE
CON DESAGÜE

SPOUT 200 MM
BEC 200 MM
CAÑO 200 MM

SIMPLE
SIMPLE
SIMPLE

SPOUT 200 MM
BEC 200 MM
CAÑO 200 MM

WITH WASTE VALVE
AVEC VIDAGE
CON DESAGÜE



SINGLE LEVER MIXER // MITIGEUR // MEZCLADOR
BUILT-IN BASIN // LAVABO À ENCASTRER
EMPOTRABLE LAVABO

SIMPLE
SIMPLE
SIMPLE

WITH WASTE VALVE
AVEC VIDAGE
CON DESAGÜE



SINGLE LEVER MIXER // MITIGEUR // MEZCLADOR
BASIN // HAUT // LAVABO

SIMPLE
SIMPLE
SIMPLE

WITH WASTE VALVE
AVEC VIDAGE
CON DESAGÜE



SINGLE LEVER MIXER // MITIGEUR // MEZCLADOR
BIDET // BIDET // BIDÉ

SIMPLE
SIMPLE
SIMPLE

WITH WASTE VALVE
AVEC VIDAGE
CON DESAGÜE



SINGLE LEVER MIXER // MITIGEUR // MEZCLADOR
BATH // BAIGNOIRE // BAÑERA

BRASS KIT ACCESSORIES + GIRAFLEX SHOWER HOSE
KIT ACCESSOIRES LAITON + FLEXIBLE DE DOUCHE GIRAFLEX
SET ACCESORIOS EN LATÓN + FLEXIBLE GIRAFLEX

ABS KIT ACCESSORIES + GIRAFLEX SHOWER HOSE
KIT ACCESSOIRES ABS + FLEXIBLE DE DOUCHE GIRAFLEX
SET ACCESORIOS EN ABS + FLEXIBLE GIRAFLEX



SINGLE LEVER MIXER // MITIGEUR // MEZCLADOR
SHOWER // DOUCHE // DUCHA

BRASS KIT ACCESSORIES + GIRAFLEX SHOWER HOSE
KIT ACCESSOIRES LAITON + FLEXIBLE DE DOUCHE GIRAFLEX
SET ACCESORIOS EN LATÓN + FLEXIBLE GIRAFLEX

ABS KIT ACCESSORIES + GIRAFLEX SHOWER HOSE
KIT ACCESSOIRES ABS + FLEXIBLE DE DOUCHE GIRAFLEX
SET ACCESORIOS EN ABS + FLEXIBLE GIRAFLEX



extensible

COLUMN // COLONNE // COLUMNA
SHOWER // DOUCHE // DUCHA

THERMOSTATIC MIX. W/ BRASS SHOWERS
MIT. THERMOSTATIQUE A/ DOUCHETTE LAITON
MEZ. THERMOSTÁTICO C/ DUCHAS DE LATÓN



THERMOSTATIC MIX. W/ ABS SHOWERS
MIT. THERMOSTATIQUE A/ DOUCHETTE ABS
MEZ. THERMOSTÁTICO C/ DUCHAS EN ABS



SINGLE LEVER MIXER W/ BRASS SHOWERS
MITIGEUR A/ DOUCHETTE LAITON
MEZCLADOR C/ DUCHAS DE LATÓN

SINGLE LEVER MIXER W/ ABS SHOWERS
MITIGEUR A/ DOUCHETTE ABS
MEZCLADOR C/ DUCHAS EN ABS





SOFT OPENING
OUVERTURE DOUX
APERTURA SUAVE

*Softness on opening and rotation.
The opening and rotation of this cartridge is up to 40% smoother than traditional cartridges due to a special design of the ceramic disks.*

*Mollesse dans l'ouverture et la rotation.
L'ouverture et la rotation de cette cartouche est jusqu'à 40% plus lisse que les cartouches traditionnelles en raison d'une conception spéciale des disques en céramique.*

*Suavidad en la apertura y la rotación.
La apertura y el giro de este cartucho es hasta un 40% más suave que los cartuchos tradicionales debido a un diseño especial de los discos cerámicos.*



COMPLETE YOUR CHOICE WITH THE RANGE OF TOWEL RAILS KEEN ON PAGE 49.
COMPLÉTEZ VOTRE CHOIX AVEC LA GAMME DE PORTE-SERVIETTES À LA PAGE 49.
COMPLETE SU ELECCIÓN CON LA GAMA DE TOALLA CARRILES PAJA EN LA PÁG. 49.



SINGLE LEVER MIXER // MITIGEUR // MEZCLADOR
BUILT-IN BASIN // LAVABO À ENCASTRER
EMPOTRABLE LAVABO

SIMPLE
SIMPLE
SIMPLE
WITH WASTE VALVE
AVEC VIDAGE
CON DESAGÜE



SINGLE LEVER MIXER // MITIGEUR // MEZCLADOR
TALL BASIN // LAVABO HAUT // LAVABO ALTO

SPOUT 150 MM BEC 150 MM CAÑO 150 MM	SIMPLE SIMPLE SIMPLE
SPOUT 150 MM BEC 150 MM CAÑO 150 MM	WITH WASTE VALVE AVEC VIDAGE CON DESAGÜE
SPOUT 200 MM BEC 200 MM CAÑO 200 MM	SIMPLE SIMPLE SIMPLE
SPOUT 200 MM BEC 200 MM CAÑO 200 MM	WITH WASTE VALVE AVEC VIDAGE CON DESAGÜE



COLUMN // COLONNE // COLUMNA
SHOWER // DOUCHE // DUCHA

THERMOSTATIC MIX. W/ ABS SHOWERS
MIT. THERMOSTATIC A/ DOUCHETTE ABS
MEZ. THERMOSTÁTICO C/ DUCHAS EN ABS
SINGLE LEVER MIXER W/ ABS SHOWERS
MITIGEUR A/ DOUCHETTE ABS
MEZCLADOR C/ DUCHAS EN ABS

380

CHROME // CHROMÉ CROMADO **ADJUSTABLE HEIGHT // RÉGLABLE EN HAUTEUR // ALTURA AJUSTABLE**



SINGLE LEVER MIXER // MITIGEUR // MEZCLADOR
BASIN // HAUT // LAVABO

SIMPLE
SIMPLE
SIMPLE
WITH WASTE VALVE
AVEC VIDAGE
CON DESAGÜE



SINGLE LEVER MIXER // MITIGEUR // MEZCLADOR
BIDET // BIDET // BIDÉ

SIMPLE
SIMPLE
SIMPLE
WITH WASTE VALVE
AVEC VIDAGE
CON DESAGÜE



SINGLE LEVER MIXER // MITIGEUR // MEZCLADOR
BATH // BAIGNOIRE // BAÑERA

ABS KIT ACCESSORIES + GIRAFLEX SHOWER HOSE
KIT ACCESSOIRES ABS + FLEXIBLE DE DOUCHE GIRAFLEX
SET ACCESÓRIOS EN ABS + FLEXIBLE GIRAFLEX

CHROME // CHROMÉ CROMADO



SINGLE LEVER MIXER // MITIGEUR // MEZCLADOR
SHOWER // DOUCHE // DUCHA

ABS KIT ACCESSORIES + GIRAFLEX SHOWER HOSE
KIT ACCESSOIRES ABS + FLEXIBLE DE DOUCHE GIRAFLEX
SET ACCESÓRIOS EN ABS + FLEXIBLE GIRAFLEX

CHROME // CHROMÉ CROMADO



SINGLE LEVER MIXER // MITIGEUR // MEZCLADOR
TALL BASIN // LAVABO HAUT // LAVABO ALTO

- SPOUT 150 MM**
BEC 150 MM
CAÑO 150 MM
- SPOUT 190 MM**
BEC 190 MM
CAÑO 190 MM
- SPOUT 190 MM**
BEC 190 MM
CAÑO 190 MM

A

B

- SIMPLE**
SIMPLE
SIMPLE
- WITH WASTE VALVE**
AVEC VIDAGE
CON DESAGÜE
- SIMPLE**
SIMPLE
SIMPLE
- WITH WASTE VALVE**
AVEC VIDAGE
CON DESAGÜE



SINGLE LEVER MIXER // MITIGEUR // MEZCLADOR
BASIN // HAUT // LAVABO

- SIMPLE**
SIMPLE
SIMPLE
- WITH WASTE VALVE**
AVEC VIDAGE
CON DESAGÜE



SINGLE LEVER MIXER // MITIGEUR // MEZCLADOR
BUILT-IN BASIN // LAVABO À ENCASTRER
EMPOTRABLE LAVABO

- SIMPLE**
SIMPLE
SIMPLE
- WITH WASTE VALVE**
AVEC VIDAGE
CON DESAGÜE



SINGLE LEVER MIXER // MITIGEUR // MEZCLADOR
BIDET // BIDET // BIDÉ

- SIMPLE**
SIMPLE
SIMPLE
- WITH WASTE VALVE**
AVEC VIDAGE
CON DESAGÜE



SINGLE LEVER MIXER // MITIGEUR // MEZCLADOR
BATH // BAIGNOIRE // BAÑERA

ABS KIT ACCESSORIES + SHOWER HOSE
KIT ACCESSOIRES ABS + FLEXIBLE DE DOUCHE
SET ACCESORIOS EN ABS + FLEXIBLE



SINGLE LEVER MIXER // MITIGEUR // MEZCLADOR
SHOWER // DOUCHE // DUCHA

ABS KIT ACCESSORIES + SHOWER HOSE
KIT ACCESSOIRES ABS + FLEXIBLE DE DOUCHE
SET ACCESORIOS EN ABS + FLEXIBLE



extendible

COLUMN // COLONNE // COLUMNA
SHOWER // DOUCHE // DUCHA

THERMOSTATIC MIX. W/ BRASS SHOWERS
MIT. THERMOSTATIQUE A/ DOUCHETTE LAITON
MEZ. TERMOSTÁTICO C/ DUCHAS DE LATÓN



THERMOSTATIC MIX. W/ ABS SHOWERS
MIT. THERMOSTATIQUE A/ DOUCHETTE ABS
MEZ. TERMOSTÁTICO C/ DUCHAS EN ABS



SINGLE LEVER MIXER W/ BRASS SHOWERS
MITIGEUR A/ DOUCHETTE LAITON
MEZCLADOR C/ DUCHAS DE LATÓN

SINGLE LEVER MIXER W/ ABS SHOWER
MITIGEUR A/ DOUCHETTE ABS
MEZCLADOR C/ DUCHAS EN ABS





SINGLE LEVER MIXER // MITIGEUR // MEZCLADOR
BUILT-IN BASIN // LAVABO À ENCASTRER
 EMPOTRABLE LAVABO

SIMPLE
 SIMPLE
 SIMPLE

WITH WASTE VALVE
 AVEC VIDAGE
 CON DESAGÜE



CHROME // CHROMÉ
 CROMADO

SINGLE LEVER MIXER // MITIGEUR // MEZCLADOR
TALL BASIN // LAVABO HAUT // LAVABO ALTO

SPOUT 150 MM
 BEC 150 MM
 CAÑO 150 MM

SIMPLE
 SIMPLE
 SIMPLE

SPOUT 150 MM
 BEC 150 MM
 CAÑO 150 MM

WITH WASTE VALVE
 AVEC VIDAGE
 CON DESAGÜE

SPOUT 200 MM
 BEC 200 MM
 CAÑO 200 MM

SIMPLE
 SIMPLE
 SIMPLE

SPOUT 200 MM
 BEC 200 MM
 CAÑO 200 MM

WITH WASTE VALVE
 AVEC VIDAGE
 CON DESAGÜE



CHROME // CHROMÉ
 CROMADO



extensible

COLUMN // COLONNE // COLUMNA
SHOWER // DOUCHE // DUCHA

THERMOSTATIC MIX. W/ BRASS SHOWERS
 MIT. THERMOSTATIC A/ DOUCHETTE LAITON
 MEZ. THERMOSTÁTICO C/ DUCHAS DE LATÓN



THERMOSTATIC MIX. W/ ABS SHOWERS
 MIT. THERMOSTATIC A/ DOUCHETTE ABS
 MEZ. THERMOSTÁTICO C/ DUCHAS EN ABS



SINGLE LEVER MIXER W/ BRASS HAND SHOWERS
 MITIGEUR A/ DOUCHETTE LAITON
 MEZCLADOR C/ DUCHAS DE LATÓN

SINGLE LEVER MIXER W/ ABS HAND SHOWERS
 MITIGEUR A/ DOUCHETTE ABS
 MEZCLADOR C/ DUCHAS EN ABS

CHROME // CHROMÉ
 CROMADO

ADJUSTABLE HEIGHT // RÉGLABLE EN
 HAUTEUR // ALTURA AJUSTABLE



SINGLE LEVER MIXER // MITIGEUR // MEZCLADOR
BASIN // HAUT // LAVABO

SIMPLE
 SIMPLE
 SIMPLE

WITH WASTE VALVE
 AVEC VIDAGE
 CON DESAGÜE



CHROME // CHROMÉ
 CROMADO



SINGLE LEVER MIXER // MITIGEUR // MEZCLADOR
BIDET // BIDET // BIDÉ

SIMPLE
 SIMPLE
 SIMPLE

WITH WASTE VALVE
 AVEC VIDAGE
 CON DESAGÜE



CHROME // CHROMÉ
 CROMADO



SINGLE LEVER MIXER // MITIGEUR // MEZCLADOR
BATH // BAIGNOIRE // BAÑERA

ABS KIT ACCESSORIES + SHOWER HOSE
 KIT ACCESSOIRES ABS + FLEXIBLE DE DOUCHE
 SET ACCESORIOS EN ABS + FLEXIBLE



CHROME // CHROMÉ
 CROMADO



SINGLE LEVER MIXER // MITIGEUR // MEZCLADOR
SHOWER // DOUCHE // DUCHA

ABS KIT ACCESSORIES + SHOWER HOSE
 KIT ACCESSOIRES ABS + FLEXIBLE DE DOUCHE
 SET ACCESORIOS EN ABS + FLEXIBLE



CHROME // CHROMÉ
 CROMADO

CARTRIDGES CERAMIC

All Ctesi® taps are equipped with ceramic cartridges, which regulate gradually and precisely the flow and water temperature. These cartridges provide greater durability and wear resistance, which ensures increased efficiency and longevity for each of our taps.



CARTRIDGES ECO SAFE

Eco-Safe Ctesi® cartridges are characterized by their opening function in two handle positions: half open and fully open.

Opening the handle only half way will give you a water flux of 50% and if you need more flow simply activate the full opening. Their we allow to reduce and increase water flow and therefore save water and energy.

CARTOUCHES CÉRAMIQUE

Tous les robinets Ctesi® sont équipés de cartouches céramiques, qui régulent progressive et précisément le débit et température de l'eau. Ces cartouches fournissent une plus grande durabilité et une résistance d'usure, ce qui assure une plus grande efficacité et longévité de chacune de nos robinets.



CARTOUCHES ECO SAFE

Les cartouches Eco-Safe Ctesi® sont caractérisées par sa fonction d'ouverture en deux positions du bouton: la moitié ouverte et complètement ouvert. Avec la moitié de l'ouverture de la poignée ont un flux d'eau de 50% et si vous avez besoin plus de débit doit actionner l'ouverture total. De cette façon, nous permettons donc d'augmenter les chances de régulation du débit d'eau et donc d'économiser de l'eau et de l'énergie.

CARTUCHOS CERÁMICA

Todos los grifos Ctesi® están equipados con cartuchos cerámicos, que regulan de forma gradual y precisa el caudal y la temperatura del agua. Estos cartuchos proporcionan una mayor durabilidad y resistencia al desgaste, lo que asegura una durabilidad más alta y longevidad a cada uno de los grifos.



CARTUCHOS ECO SAFE

Los cartuchos Ctesi® Eco-Safe se caracterizan por su función de apertura de los mandos en dos posiciones: medio abiertos y completamente abiertos.

Con la mitad de la abertura tiene un flujo de agua de 50% y si necesita más flujo debe accionar la apertura total. De esta forma se permite aumentar y reducir el flujo de agua y con eso ahorrar agua y energía.



SINGLE LEVER MIXER // MITIGEUR // MEZCLADOR
BASIN // LAVABO // LAVABO

SIMPLE
SIMPLE
SIMPLE

WITH WASTE VALVE
AVEC VIDAGE
CON DESAGÜE



SINGLE LEVER MIXER // MITIGEUR // MEZCLADOR
BIDET // BIDET // BIDÉ

SIMPLE
SIMPLE
SIMPLE

WITH WASTE VALVE
AVEC VIDAGE
CON DESAGÜE



SINGLE LEVER MIXER // MITIGEUR // MEZCLADOR
BATH // BAIGNOIRE // BAÑERA

ABS KIT ACCESSORIES + SHOWER HOSE
KIT ACCESSOIRES ABS + FLEXIBLE DE DOUCHE
SET ACCESORIOS EN ABS + FLEXIBLE



SINGLE LEVER MIXER // MITIGEUR // MEZCLADOR
SHOWER // DOUCHE // DUCHA

ABS KIT ACCESSORIES + SHOWER HOSE
KIT ACCESSOIRES ABS + FLEXIBLE DE DOUCHE
SET ACCESORIOS EN ABS + FLEXIBLE





**COLUMN // COLONNE // COLUMNA
SHOWER // DOUCHE // DUCHA**

**SINGLE LEVER MIXER W/ BRASS SHOWERS
MITIGEUR A/ DOUCHETTE LAITON
MEZCLADOR C/ DUCHAS DE LATÓN**

**SINGLE LEVER MIXER W/ ABS SHOWERS
MITIGEUR A/ DOUCHETTE ABS
MEZCLADOR C/ DUCHAS EN ABS**

CHROME // CHROMÉ CROMADO ADJUSTABLE HEIGHT // RÉGLABLE EN HAUTEUR // ALTURA AJUSTABLE



**SINGLE LEVER MIXER // MITIGEUR // MEZCLADOR
BASIN // LAVABO // LAVABO**

**SIMPLE
SIMPLE
SIMPLE**
**WITH WASTE VALVE
AVEC VIDAGE
CON DESAGÜE**

CHROME // CHROMÉ CROMADO



**SINGLE LEVER MIXER // MITIGEUR // MEZCLADOR
BIDET // BIDET // BIDÉ**

**SIMPLE
SIMPLE
SIMPLE**
**WITH WASTE VALVE
AVEC VIDAGE
CON DESAGÜE**

CHROME // CHROMÉ CROMADO



**SINGLE LEVER MIXER // MITIGEUR // MEZCLADOR
BATH // BAIGNOIRE // BAÑERA**

**ABS KIT ACCESSORIES + SHOWER HOSE
KIT ACCESSOIRES ABS + FLEXIBLE DE DOUCHE
SET ACCESORIOS EN ABS + FLEXIBLE**

CHROME // CHROMÉ CROMADO



**THERMOSTATIC MIXER // MITIGEUR THERMOSTATIC
MEZCLADOR TERMOSTÁTICO**

BATH // BAIGNOIRE // BAÑERA

**ABS KIT ACCESSORIES + SHOWER HOSE
KIT ACCESSOIRES ABS + FLEXIBLE DE DOUCHE
SET ACCESORIOS EN ABS + FLEXIBLE**

CHROME // CHROMÉ CROMADO

38



**SINGLE LEVER MIXER // MITIGEUR // MEZCLADOR
HAIRDRESSER // COIFFEUR // PELUQUERIA**

**WITH PULL-OUT SHOWER
AVEC DOUCHETTE RÉTRACTABLE
CON DUCHA EXTRAIBLE**

CHROME // CHROMÉ CROMADO



**SINGLE LEVER MIXER // MITIGEUR // MEZCLADOR
SHOWER // DOUCHE // DUCHA**

**ABS KIT ACCESSORIES + SHOWER HOSE
KIT ACCESSOIRES ABS + FLEXIBLE DE DOUCHE
SET ACCESORIOS EN ABS + FLEXIBLE**

CHROME // CHROMÉ CROMADO



**THERMOSTATIC MIXER // MITIGEUR THERMOSTATIC
MEZCLADOR TERMOSTÁTICO**

SHOWER // DOUCHE // DUCHA

**ABS KIT ACCESSORIES + SHOWER HOSE
KIT ACCESSOIRES ABS + FLEXIBLE DE DOUCHE
SET ACCESORIOS EN ABS + FLEXIBLE**

CHROME // CHROMÉ CROMADO

38



SINGLE LEVER MIXER // MITIGEUR // MEZCLADOR
BASIN // LAVABO // LAVABO

HEIGHT 88 MM
HAUTEUR 88 MM
ALTURA 88 MM

SIMPLE
SIMPLE
SIMPLE

HEIGHT 88 MM
HAUTEUR 88 MM
ALTURA 88 MM

WITH WASTE VALVE
AVEC VIDAGE
CON DESAGÜE

HEIGHT 122 MM
HAUTEUR 122 MM
ALTURA 122 MM

SIMPLE
SIMPLE
SIMPLE

HEIGHT 122 MM
HAUTEUR 122 MM
ALTURA 122 MM

WITH WASTE VALVE
AVEC VIDAGE
CON DESAGÜE



SINGLE LEVER MIXER // MITIGEUR // MEZCLADOR
BIDET // BIDET // BIDÉ

SIMPLE
SIMPLE
SIMPLE

WITH WASTE VALVE
AVEC VIDAGE
CON DESAGÜE



SINGLE LEVER MIXER // MITIGEUR // MEZCLADOR
BATH // BAIGNOIRE // BAÑERA

ABS KIT ACCESSORIES + SHOWER HOSE
KIT ACCESSOIRES ABS + FLEXIBLE DE DOUCHE
SET ACCESORIOS EN ABS + FLEXIBLE



SINGLE LEVER MIXER // MITIGEUR // MEZCLADOR
SHOWER // DOUCHE // DUCHA

ABS KIT ACCESSORIES + SHOWER HOSE
KIT ACCESSOIRES ABS + FLEXIBLE DE DOUCHE
SET ACCESORIOS EN ABS + FLEXIBLE



extensible

COLUMN // COLONNE // COLUMNA
SHOWER // DOUCHE // DUCHA

SINGLE LEVER MIXER W/ BRASS SHOWERS
MITIGEUR A/ DOUCHETTE LAITON
MEZCLADOR C/ DUCHAS DE LATÓN

SINGLE LEVER MIXER W/ ABS HAND SHOWERS
MITIGEUR A/ DOUCHETTE ABS
MEZCLADOR C/ DUCHASO EN ABS





SINGLE LEVER MIXER // MITIGEUR // MEZCLADOR
BASIN // LAVABO // LAVABO

SIMPLE
 SIMPLE
 SIMPLE

WITH AUTOMATIC WASTE VALVE
 AVEC VIDAGE AUTOMATIQUE
 CON DESAGÜE AUTOMÁTICO



SINGLE LEVER MIXER // MITIGEUR // MEZCLADOR
BIDET // BIDET // BIDÉ

SIMPLE
 SIMPLE
 SIMPLE

WITH AUTOMATIC WASTE VALVE
 AVEC VIDAGE AUTOMATIQUE
 CON DESAGÜE AUTOMÁTICO



SINGLE LEVER MIXER // MITIGEUR // MEZCLADOR
BATH // BAIGNOIRE // BAÑERA

ABS KIT ACCESSORIES + SHOWER HOSE
 KIT ACCESSOIRES ABS + FLEXIBLE DE DOUCHE
 SET ACCESORIOS EN ABS + FLEXIBLE



SINGLE LEVER MIXER // MITIGEUR // MEZCLADOR
SHOWER // DOUCHE // DUCHA

ABS KIT ACCESSORIES + SHOWER HOSE
 KIT ACCESSOIRES ABS + FLEXIBLE DE DOUCHE
 SET ACCESORIOS EN ABS + FLEXIBLE



**NEW
NOUVEAU
NUEVO** DESIGN

+ **MODERN**
+ STRAIGHT LINE

+ **MODERNE**
+ RECTILIGNE

+ **MODERNO**
+ RECTILÍNEO



SINGLE LEVER MIXER // MITIGEUR // MEZCLADOR
BASIN // LAVABO // LAVABO

SIMPLE
SIMPLE
SIMPLE

WITH WASTE VALVE
AVEC VIDAGE
CON DESAGÜE



SINGLE LEVER MIXER // MITIGEUR // MEZCLADOR
BIDET // BIDET // BIDÉ

SIMPLE
SIMPLE
SIMPLE

WITH WASTE VALVE
AVEC VIDAGE
CON DESAGÜE



SINGLE LEVER MIXER // MITIGEUR // MEZCLADOR
BATH // BAIGNOIRE // BAÑERA

ABS KIT ACCESSORIES + SHOWER HOSE
KIT ACCESSOIRES ABS + FLEXIBLE DE DOUCHE
SET ACCESORIOS EN ABS + FLEXIBLE



SINGLE LEVER MIXER // MITIGEUR // MEZCLADOR
SHOWER // DOUCHE // DUCHA

ABS KIT ACCESSORIES + SHOWER HOSE
KIT ACCESSOIRES ABS + FLEXIBLE DE DOUCHE
SET ACCESORIOS EN ABS + FLEXIBLE



HANDLE 1/4 TURN

These taps are fitted with ceramic headwork that allow you to open the maximum flow tap running only 1/4 of the handle. This technology allows an easier control of the intended water flow and speeds up the handling while reducing the waste of water and energy.

POIGNÉE 1/4 TOUR

Ces robinets sont équipés avec des têtes céramiques qui vous permettent d'ouvrir le robinet au débit maximal en cours seulement avec la rotation de 1/4 de tour du poignée. Cette technologie facilite le contrôle des flux de l'eau qu'on veut et rationalise l'utilisation du robinet tout en réduisant les déchets de l'eau et de l'énergie.

MONTURA 1/4 VUELTA

Estos grifos están equipados con cartuchos de montura cerámica que le permiten abrir el grifo con el flujo máximo corriendo solamente 1/4 del manipulo. Esta tecnología permite un control más fácil del flujo de agua que se pretende y simplifica el manejo del grifo, mientras que permite la reducción de la pérdida de agua y energía.



**TWO HANDLE MIXER // MÉLANGEUR // MEZCLADOR BIMANDO
BASIN // HAUT // LAVABO**

SIMPLE
SIMPLE
SIMPLE

WITH WASTE VALVE
AVEC VIDAGE
CON DESAGÜE



**TWO HANDLE MIXER // MÉLANGEUR // MEZCLADOR BIMANDO
BUILT-IN BASIN // LAVABO À ENCASTRER
EMPOTRABLE LAVABO**

SIMPLE
SIMPLE
SIMPLE

WITH WASTE VALVE
AVEC VIDAGE
CON DESAGÜE



**TWO HANDLE MIXER // MÉLANGEUR // MEZCLADOR BIMANDO
BIDET // BIDET // BIDÉ**

SIMPLE
SIMPLE
SIMPLE

WITH WASTE VALVE
AVEC VIDAGE
CON DESAGÜE



**TWO HANDLE MIXER // MÉLANGEUR // MEZCLADOR BIMANDO
BATH // BAIGNOIRE // BAÑERA**

BRASS KIT ACCESSORIES + GIRAFLEX SHOWER HOSE
KIT ACCESSOIRES LAITON + FLEXIBLE DE DOUCHE GIRAFLEX
SET ACCESORIOS EN LATÓN + FLEXIBLE GIRAFLEX

ABS KIT ACCESSORIES + GIRAFLEX SHOWER HOSE
KIT ACCESSOIRES ABS + FLEXIBLE DE DOUCHE GIRAFLEX
SET ACCESORIOS EN ABS + FLEXIBLE GIRAFLEX



**TWO HANDLE MIXER // MÉLANGEUR // MEZCLADOR BIMANDO
SHOWER // DOUCHE // DUCHA**

BRASS KIT ACCESSORIES + GIRAFLEX SHOWER HOSE
KIT ACCESSOIRES LAITON + FLEXIBLE DE DOUCHE GIRAFLEX
SET ACCESORIOS EN LATÓN + FLEXIBLE GIRAFLEX

ABS KIT ACCESSORIES + GIRAFLEX SHOWER HOSE
KIT ACCESSOIRES ABS + FLEXIBLE DE DOUCHE GIRAFLEX
SET ACCESORIOS EN ABS + FLEXIBLE GIRAFLEX



**COLUMN // COLONNE // COLUMNA
SHOWER // DOUCHE // DUCHA**

SINGLE LEVER MIXER W/ BRASS SHOWERS
MITIGEUR A/ DOUCHETTE LAITON
MEZCLADOR C/ DUCHAS DE LATÓN





+
1/4 TURN
1/4 TOUR
1/4 VUELTA



TWO HANDLE MIXER // MÉLANGEUR // MEZCLADOR BIMANDO
BATH // BAIGNOIRE // BAÑERA

BRASS KIT ACCESSORIES + SHOWER HOSE
KIT ACCESSOIRES LAITON + FLEXIBLE DE DOUCHE
SET ACCESORIOS EN LATÓN + FLEXIBLE

CHROME // CHROMÉ
CROMADO



TWO HANDLE MIXER // MÉLANGEUR
MEZCLADOR BIMANDO
BASIN // HAUT // LAVABO

SIMPLE
SIMPLE
SIMPLE

WITH WASTE VALVE
AVEC VIDAGE
CON DESAGÜE

CHROME // CHROMÉ
CROMADO



TWO HANDLE MIXER // MÉLANGEUR
MEZCLADOR BIMANDO
BIDET // BIDET // BIDÉ

SIMPLE
SIMPLE
SIMPLE

WITH WASTE VALVE
AVEC VIDAGE
CON DESAGÜE

CHROME // CHROMÉ
CROMADO



TWO HANDLE MIXER // MÉLANGEUR
MEZCLADOR BIMANDO
SHOWER // DOUCHE // DUCHA

BRASS KIT ACCESSORIES + SHOWER HOSE
KIT ACCESSOIRES LAITON + FLEXIBLE DE DOUCHE
SET ACCESORIOS EN LATÓN + FLEXIBLE

CHROME // CHROMÉ
CROMADO



TAP // ROBINET // GRIFERÍA
BASIN // HAUT // LAVABO

COLD
FROID
FRIA

HOT
CHAUD
CALIENTE

CHROME // CHROMÉ
CROMADO

SIMPLY SINGLE WATER TAP // ROBINETS D'UNE EAU // GRIFERÍA DE UNA AGUA



TAPS 1 WATER

The SIMPLY range offers a solution of 1 water taps.
This solution projects a flow of one water, this is only cold or premixed water so getting a controlled temperature while saving energy, particularly in public spaces.

ROBINETS 1 EAU

La gamme SIMPLY offre une solution de robinets d'une eau.
Cette solution projette un flux d'une eau seulement, ceci est uniquement de l'eau froide ou prémélangée obtenant ainsi une température contrôlée tout en économisant de l'énergie, en particulier dans les espaces publics.

GRIFOS 1 AGUA

La gama SIMPLY ofrece una solución de grifos de 1 agua.
Esta solución proyecta un flujo de solamente 1 agua, esto es sólo agua fría o premezclada, obteniendo de este modo una temperatura controlada, mientras que ahorra energía, en particular en los espacios públicos.



TAP // ROBINET // GRIFERÍA
BASIN // HAUT // LAVABO

SIMPLE
SIMPLE
SIMPLE

CHROME // CHROMÉ
CROMADO



TAP // ROBINET // GRIFERÍA
WALL MOUNTED // MURAL // MURO

1/2"

CHROME // CHROMÉ
CROMADO



TAP // ROBINET // GRIFERÍA
SINK // ÉVIER // FREGADERO

LOW SPOUT
BEC BAS
CAÑO BAJO

CHROME // CHROMÉ
CROMADO



TAP // ROBINET // GRIFERÍA
SINK // ÉVIER // FREGADERO

HIGH SPOUT
BEC HAUT
CAÑO ALTO

CHROME // CHROMÉ
CROMADO

COZI SERIES

We extended the design concept that defines Ctesi®, to a collection of practical kitchen taps offering the same familiar design, aesthetics and functionality with the aiming to improve your day-to-day use.

Nous prolongeons le concept derrière le design définissant de Ctesi® à une collection des robinets de cuisine pratiques, familiales et équipés avec les détails esthétiques et fonctionnels qui améliorent votre quotidien dans la cuisine.

Hemos ampliado el concepto de diseño que define Ctesi®, a una colección de grifos de cocina prácticos que presentan el mismo diseño familiar, la estética y la funcionalidad con el fin de mejorar el uso en el día a día.



KEEN

EASY INSTALLATION // INSTALLATION FACILE // FÁCIL INSTALACIÓN



KEEN

SINGLE LEVER MIXER // MITIGEUR // MEZCLADOR
SINK // ÉVIER // FREGADERO

FLEXIBLE SHOWER
DOUCHETTE FLEXIBLE
DUCHA FLEXIBLE

CHROME // CHROMÉ
CROMADO



KEEN

SINGLE LEVER MIXER // MITIGEUR // MEZCLADOR
SINK // ÉVIER // FREGADERO

PULL-OUT SHOWER
DOUCHETTE RÉTRACTABLE
DUCHA EXTRAÍBLE

CHROME // CHROMÉ
CROMADO



SMART

SINGLE LEVER MIXER // MITIGEUR // MEZCLADOR
SINK // ÉVIER // FREGADERO

FLEXIBLE AND SPOUT
FLEXIBLE ET BEC
FLEXIBLE Y CAÑO

CHROME // CHROMÉ
CROMADO



SMART

SINGLE LEVER MIXER // MITIGEUR // MEZCLADOR
SINK // ÉVIER // FREGADERO

FLEXIBLE
FLEXIBLE
FLEXIBLE

CHROME // CHROMÉ
CROMADO



SMART

SINGLE LEVER MIXER // MITIGEUR // MEZCLADOR
SINK // ÉVIER // FREGADERO

HIGH SPOUT
BEC HAUT
CAÑO ALTO

CHROME // CHROMÉ
CROMADO



FOCUS

SINGLE LEVER MIXER // MITIGEUR // MEZCLADOR
SINK // ÉVIER // FREGADERO

RECLINING HIGH SPOUT
BEC HAUT BASCULANT
CAÑO ALTO ABATIBLE

CHROME // CHROMÉ
CROMADO



NEXT

SINGLE LEVER MIXER // MITIGEUR // MEZCLADOR
SINK // ÉVIER // FREGADERO

HIGH SPOUT
BEC HAUT
CAÑO ALTO

CHROME // CHROMÉ
CROMADO



PIXEL

SINGLE LEVER MIXER // MITIGEUR // MEZCLADOR
SINK // ÉVIER // FREGADERO

HIGH SPOUT
BEC HAUT
CAÑO ALTO

CHROME // CHROMÉ
CROMADO



PRISMA

SINGLE LEVER MIXER // MITIGEUR // MEZCLADOR
SINK // ÉVIER // FREGADERO

HIGH SPOUT
BEC HAUT
CAÑO ALTO

CHROME // CHROMÉ
CROMADO



STAR

TWO HANDLE MIXER // MÉLANGEUR MEZCLADOR BIMANDO
SINK // ÉVIER // FREGADERO

HIGH SPOUT
BEC HAUT
CAÑO ALTO

CHROME // CHROMÉ
CROMADO



ORION

SINGLE LEVER MIXER // MITIGEUR // MEZCLADOR
SINK // ÉVIER // FREGADERO

ROTATING HIGH SPOUT
BEC HAUT ROTATIF
CAÑO ALTO GIRATORIO

CHROME // CHROMÉ
CROMADO



ORION

MONOCOMANDO
BALCÃO

HORIZONTAL HIGH SPOUT
BEC HAUT HORIZONTAL
CAÑO ALTO HORIZONTAL

CHROME // CHROMÉ
CROMADO



ORION

SINGLE LEVER MIXER // MITIGEUR // MEZCLADOR
SINK // ÉVIER // FREGADERO

HIGH SPOUT
BEC HAUT
CAÑO ALTO

CHROME // CHROMÉ
CROMADO



FOCUS

SINGLE LEVER MIXER // MITIGEUR // MEZCLADOR
SINK // ÉVIER // FREGADERO

HIGH CAST SPOUT
BEC HAUT FONDU
CAÑO ALTO FUNDIDO

CHROME // CHROMÉ
CROMADO



FOCUS

SINGLE LEVER MIXER // MITIGEUR // MEZCLADOR
SINK // ÉVIER // FREGADERO

HIGH TUBE SPOUT
BEC HAUT TUBE
CAÑO TUBO ALTO

CHROME // CHROMÉ
CROMADO



HARPA

SINGLE LEVER MIXER // MITIGEUR // MEZCLADOR
SINK // ÉVIER // FREGADERO

HIGH SPOUT
BEC HAUT
CAÑO ALTO

CHROME // CHROMÉ
CROMADO



DOMAN

SINGLE LEVER MIXER // MITIGEUR // MEZCLADOR
SINK // ÉVIER // FREGADERO

HIGH SPOUT
BEC HAUT
CAÑO ALTO

CHROME // CHROMÉ
CROMADO



GOAL

SINGLE LEVER MIXER // MITIGEUR // MEZCLADOR
SINK // ÉVIER // FREGADERO

HIGH SPOUT
BEC HAUT
CAÑO ALTO

CHROME // CHROMÉ
CROMADO



VINTAGE

SINGLE LEVER MIXER // MITIGEUR // MEZCLADOR
SINK // ÉVIER // FREGADERO

HIGH SPOUT
BEC HAUT
CAÑO ALTO

CHROME // CHROMÉ
CROMADO



ELBA

SINGLE LEVER MIXER // MITIGEUR // MEZCLADOR
SINK // ÉVIER // FREGADERO

HIGH SPOUT
BEC HAUT
CAÑO ALTO

CHROME // CHROMÉ
CROMADO



DOMAN

SINGLE LEVER MIXER // MITIGEUR // MEZCLADOR
SINK // ÉVIER // FREGADERO

PULL-OUT SHOWER
DOUCHETTE RÉTRACTABLE
DUCHA EXTRAIBLE

CHROME // CHROMÉ
CROMADO



GOAL

SINGLE LEVER MIXER // MITIGEUR // MEZCLADOR
SINK // ÉVIER // FREGADERO

PULL-OUT SHOWER
DOUCHETTE RÉTRACTABLE
DUCHA EXTRAIBLE

CHROME // CHROMÉ
CROMADO



DOMAN

SINGLE LEVER MIXER // MITIGEUR // MEZCLADOR
SINK // ÉVIER // FREGADERO

PULL-OUT SHOWER
DOUCHETTE RÉTRACTABLE
DUCHA EXTRAIBLE

CHROME // CHROMÉ
CROMADO



GOAL

SINGLE LEVER MIXER // MITIGEUR // MEZCLADOR
SINK // ÉVIER // FREGADERO

PULL-OUT SHOWER
DOUCHETTE RÉTRACTABLE
DUCHA EXTRAIBLE

CHROME // CHROMÉ
CROMADO



**SHOWERS
KITCHEN TAPS**

The kitchen Taps Showers Ctesi® with extractable shower are equipped with an extendable hose in the body, to help wash the sink and other large pieces, giving it more functionality and freedom of movement in your kitchen.

**DOUCHES
ROBINETS DE CUISINE**

Les robinets de cuisine Ctesi® avec douche extractible sont équipées d'un tuyau extensible dans le corps, pour aider à laver l'évier et d'autres gros pièces, ce qui lui donne plus de fonctionnalité et liberté de mouvement dans votre cuisine.

**DUCHAS
GRIFOS DE COCINA**

Los grifos de cocina con ducha extraíble Ctesi® están equipados con una manguera extensible en su cuerpo, para ayudar a limpiar el fregadero y otras piezas de gran tamaño, dándole más funcionalidad y libertad de movimiento en su cocina.



ORION

SINGLE LEVER MIXER // MITIGEUR // MEZCLADOR
SINK // ÉVIER // FREGADERO

LOW SPOUT
BEC BAS
CAÑO BAJO

CHROME // CHROMÉ
CROMADO



DOMAN

SINGLE LEVER MIXER // MITIGEUR // MEZCLADOR
WALL MOUNTED SINK // ÉVIER MURAL
MURAL FREGADERO

LOW SPOUT
BEC INFÉRIEURE
CAÑO INFERIOR

CHROME // CHROMÉ
CROMADO



DOMAN

SINGLE LEVER MIXER // MITIGEUR // MEZCLADOR
WALL MOUNTED SINK // ÉVIER MURAL
MURAL FREGADERO

HIGH SPOUT
BEC SUPÉRIEURE
CAÑO SUPERIOR

CHROME // CHROMÉ
CROMADO



FOCUS

SINGLE LEVER MIXER // MITIGEUR // MEZCLADOR
SINK // ÉVIER // FREGADERO

LOW SPOUT
BEC BAS
CAÑO BAJO

CHROME // CHROMÉ
CROMADO



GOAL

SINGLE LEVER MIXER // MITIGEUR // MEZCLADOR
WALL MOUNTED SINK // ÉVIER MURAL
MURAL FREGADERO

LOW SPOUT
BEC INFÉRIEURE
CAÑO INFERIOR

CHROME // CHROMÉ
CROMADO



GOAL

SINGLE LEVER MIXER // MITIGEUR // MEZCLADOR
WALL MOUNTED SINK // ÉVIER MURAL
MURAL FREGADERO

HIGH SPOUT
BEC SUPÉRIEURE
CAÑO SUPERIOR

CHROME // CHROMÉ
CROMADO



DOMAN

SINGLE LEVER MIXER // MITIGEUR // MEZCLADOR
SINK // ÉVIER // FREGADERO

LOW SPOUT
BEC BAS
CAÑO BAJO

CHROME // CHROMÉ
CROMADO



FOCUS

SINGLE LEVER MIXER // MITIGEUR // MEZCLADOR
WALL MOUNTED SINK // ÉVIER MURAL
MURAL FREGADERO

HIGH CAST SPOUT
BEC SUPÉRIEURE FONDU
CAÑO SUPERIOR FUNDIDO

CHROME // CHROMÉ
CROMADO



ELBA

SINGLE LEVER MIXER // MITIGEUR // MEZCLADOR
WALL MOUNTED SINK // ÉVIER MURAL
MURAL FREGADERO

HIGH SPOUT
BEC SUPÉRIEURE
CAÑO SUPERIOR

CHROME // CHROMÉ
CROMADO



GOAL

SINGLE LEVER MIXER // MITIGEUR // MEZCLADOR
SINK // ÉVIER // FREGADERO

LOW SPOUT
BEC BAS
CAÑO BAJO

CHROME // CHROMÉ
CROMADO



DOMAN

SINGLE LEVER MIXER // MITIGEUR // MEZCLADOR
WALL MOUNTED SINK // ÉVIER MURAL
MURAL FREGADERO

HIGH TUBE SPOUT
BEC SUPÉRIEURE TUBE
CAÑO TUBO SUPERIOR

CHROME // CHROMÉ
CROMADO



VINTAGE

TWO HANDLE MIXER // MÉLANGEUR MEZCLADOR BIMANDO
WALL MOUNTED SINK // ÉVIER MURAL
MURAL FREGADERO

HIGH SPOUT
BEC SUPÉRIEURE
CAÑO SUPERIOR

CHROME // CHROMÉ
CROMADO



INDUSTRIAL SERIES

Ctesi® offers a line of industrial taps for professional use where robustness, ergonomics and reliability are a daily requirement of the most demanding professionals.

Ctesi® propose une gamme de robinets industriels pour une utilisation professionnelle où la robustesse, l'ergonomie et la fiabilité sont une exigence quotidienne des professionnels plus exigeants.

Ctesi® ofrece una línea de grifos industriales para uso profesional donde la robustez, ergonomía y la fiabilidad son un requerimiento diario de los profesionales más exigentes.



- . Worktop assembly
- . Wall fixing
- . Stainless steel tube
- . Brass shower
- . Ideal for foot operated tap

- . Application sur plan
- . Fixation mural
- . Tube en inox
- . Douchette en laiton
- . Approprié a robinet de pied

- . Instalación sobre encimera
- . Fixación à pared
- . Caño en acero inoxidable
- . Ducha en latón
- . Adecuado para grifo pedal suelo

- . Worktop assembly
- . Wall fixing
- . Stainless steel tube
- . Brass shower
- . Single lever

- . Application sur plan
- . Fixation mural
- . Tube en inox
- . Douchette en laiton
- . Mitigeur

- . Instalación sobre encimera
- . Fixación à pared
- . Caño en acero inoxidable
- . Ducha en latón
- . Monomando

- . Worktop assembly
- . Wall fixing
- . Stainless steel tube
- . Brass shower
- . Ideal for foot operated tap
- . With spout
- . With diverter

- . Application sur plan
- . Fixation mural
- . Tube en inox
- . Douchette en laiton
- . Approprié a robinet de pied
- . Avec bec
- . Avec inverseur

- . Instalación sobre encimera
- . Fixación à pared
- . Caño en acero inoxidable
- . Ducha en latón
- . Adecuado para grifo pedal suelo
- . Con caño
- . Con inversor

- . Worktop assembly
- . Wall fixing
- . Stainless steel tube
- . Brass shower
- . Single lever
- . With spout
- . With diverter

- . Application sur plan
- . Fixation mural
- . Tube en inox
- . Douchette en laiton
- . Mitigeur
- . Avec bec
- . Avec inverseur

- . Instalación sobre encimera
- . Fixación à pared
- . Caño en acero inoxidable
- . Ducha en latón
- . Monomando
- . Con caño
- . Con inversor



INDUSTRIAL TAP
ROBINET INDUSTRIELLE
COCINA INDUSTRIAL

SIMPLE
SIMPLE
SIMPLE

CHROME // CHROMÉ
CROMADO



INDUSTRIAL TAP
ROBINET INDUSTRIELLE
COCINA INDUSTRIAL

SINGLE LEVER MIXER
MITIGEUR
MONOMANDO

CHROME // CHROMÉ
CROMADO



INDUSTRIAL TAP
ROBINET INDUSTRIELLE
COCINA INDUSTRIAL

WITH SPOUT
AVEC BEC
CON CAÑO

CHROME // CHROMÉ
CROMADO



INDUSTRIAL TAP
ROBINET INDUSTRIELLE
COCINA INDUSTRIAL

SINGLE LEVER MIXER WITH SPOUT
MITIGEUR AVEC BEC
MONOMANDO CON CAÑO

CHROME // CHROMÉ
CROMADO



SHOWER SYSTEMS

BUILD YOUR BUILT-IN SHOWER SYSTEM...

IT IS VERY EASY AND YOUR BATHROOM SPACE WILL BE BETTER!

The CTESI® puts at your disposal a wide range of solutions for embedded showers "shower systems" that allows multiple combinations according your liking.

Choose your wall or ceiling shower in round or square shapes in a wide range of measurements. Elect your tap, choosing by thermostatic mixers or one, two or three outputs of water.

You can choose also the number and type of side jets according to your will and needs for cervical, dorsal or lumbar hydromassage. End with the output of water and hand shower that reflects your style and enjoy a relaxing shower in an environment tailored to your desires.

CONSTRUISEZ VOTRE SYSTÈME DE DOUCHE INTÉGRÉ...

IL EST TRÈS FACILE ET VOTRE SALLE DE BAINS SERA MEILLEUR!

CTESI® offre à ses clients une large gamme de solutions pour encastrer les douches " shower systems " qui vous permettent multiples combinaisons à votre goût.

Choisissez votre douche au mur ou au plafond aux formes rondes ou carrées dans un large éventail de mesures. Elisez votre robinet, en optant pour des mélangeurs thermostatiques ou d' un, deux ou trois sorties d'eau.

Vous pouvez également choisir le nombre et le type de jets latéraux selon votre désir et le besoin d'une hydromassage cervical, dorsal ou lombaire. Terminez avec la sortie de l'eau et douche à main qui reflètent votre style et profitez d'une douche relaxante dans un environnement construit en fonction de vos désirs.

CONSTRUYE TU SISTEMA DE DUCHA INCORPORADA...

ES MUY FÁCIL Y TU ESPACIO DE BAÑO SERÁ MEJOR!

CTESI® ofrece a sus clientes una amplia gama de soluciones para duchas incrustadas "Shower Systems" que permiten múltiples combinaciones a su gusto.

Elige su ducha de pared o del techo en formas redondas o cuadradas en una amplia gama de medidas. Elige su grifo, optando por los mezcladores termostáticos o de uno, dos o tres salidas de agua.

También puede elegir el número y tipo de chorros laterales según su deseo y necesidad de hidromasaje cervical, dorsal o lumbar. Finalice con la salida de agua y ducha de mano que reflejan su estilo y disfrute de una ducha relajante en un entorno construido para satisfacer sus deseos.



CITY Ø200MM
BRASS FIXED SHOWER HEAD
POMME DE DOUCHE LAITON
ROCIADORES DE DUCHA DE TECHO
DE LATÓN



CILIN 300MM
SHOWER ARM
BRAS DE DOUCHE
SOPORTE A PARED



CITY
SINGLE LEVER MIXER
MITIGEUR
MEZCLADOR

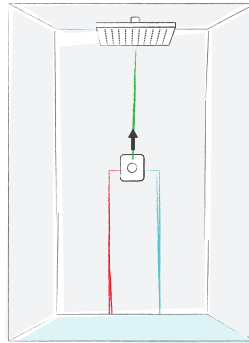

— COLD WATER // EAU FROIDE // AGUA FRIA
— HOT WATER // EAU CHAUDE // AGUA CALIENTE
— TEMPERATE WATER // EAU TEMPERÉE // AGUA TEMPLADA

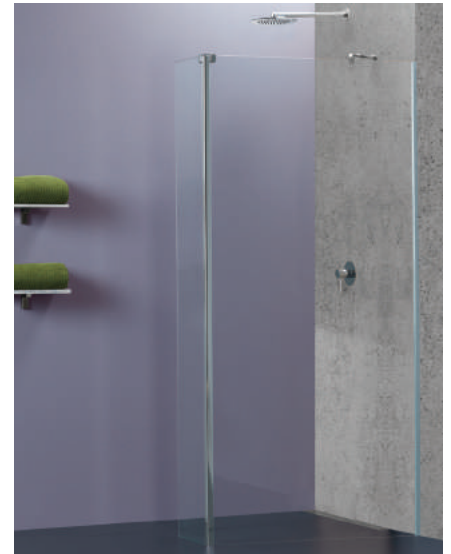

REPRESENTATIVE ILLUSTRATION 1 OUTPUT SYSTEM
ILLUSTRATION REPRESENTANT 1 SORTIE SYSTEME
ILUSTRACIÓN REPRESENTANTE DEL SISTEMA 1 SALIDA

KIT 1 OUTPUT // KIT 1 SORTIE // KIT 1 SALIDA
KIT 3 PIECES // KIT 3 PIÈCES // KIT 3 PIEZAS

CHROME // CHROMÉ
CROMADO



CITY Ø200MM
BRASS FIXED SHOWER HEAD
POMME DE DOUCHE LAITON
ROCIADORES DE DUCHA DE TECHO
DE LATÓN



CILIN 300MM
SHOWER ARM
BRAS DE DOUCHE
SOPORTE A PARED



CITY
**SINGLE LEVER MIXER W/ 2 OUTPUT
AND DIVERTER**
MITIGEUR A/ 2 SORTIES ET INVERSEUR
MEZCLADOR C/ 2 SALIDAS
E INVERSOR

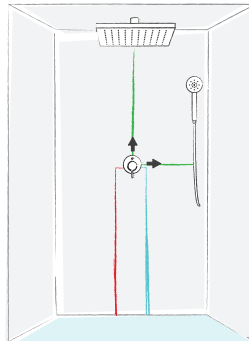

— COLD WATER // EAU FROIDE // AGUA FRIA
— HOT WATER // EAU CHAUDE // AGUA CALIENTE
— TEMPERATE WATER // EAU TEMPERÉE // AGUA TEMPLADA



REPRESENTATIVE ILLUSTRATION 2 OUTPUT SYSTEM
ILLUSTRATION REPRESENTANT 2 SORTIES SYSTEME
ILUSTRACIÓN REPRESENTANTE DEL SISTEMA 2 SALIDAS

KIT 2 OUTPUT // KIT 2 SORTIES // KIT 2 SALIDAS
KIT 6 PIECES // KIT 6 PIÈCES // KIT 6 PIEZAS

CHROME // CHROMÉ
CROMADO



CILIN
BRASS HAND SHOWER
DOUCHETTE LAITON
DUCHA EN LATÓN



CILIN
WALL ELBOW OUTLET W/ SHOWER HOLDER
COUDE SORTIE D'EAU A/ SUPPORT
TOMA DE AGUA CON SOPORTE PARA DUCHA



GIRAFLEX 150CM
SHOWER HOSE
FLEXIBLE DE DOUCHE
FLEXIBLE



REPRESENTATIVE ILLUSTRATION 3 OUTPUT SYSTEM
ILLUSTRATION REPRESENTANT 3 SORTIES SYSTEME
ILUSTRACIÓN REPRESENTANTE DEL SISTEMA 3 SALIDAS



CUBE 200 X 200MM
BRASS FIXED SHOWER HEAD
POMME DE DOUCHE LAITON
ROCIADORES DE DUCHA DE TECHO
DE LATÓN



CUBE 300MM
SHOWER ARM
BRAS DE DOUCHE
SOPORTE A PARED



CUBE
BRASS HAND SHOWER
DOUCHETTE LAITON
DUCHA EN LATÓN



CUBE
WALL ELBOW OUTLET W/ SHOWER HOLDER
COUDE SORTIE D'EAU A/ SUPPORT
TOMA DE AGUA CON SOPORTE PARA DUCHA



GIRAFLEX 150CM
SHOWER HOSE
FLEXIBLE DE DOUCHE
FLEXIBLE



CUBE
BODY JET
DOUCHETTE LATÉRALE
JET DE DUCHA



CUBE
SINGLE LEVER MIXER
MITIGEUR
MEZCLADOR



CUBE
DIVERTER W/ 3 OUTPUT
INVERSEUR A/ 3 SORTIES
INVERSOR C/ 3 SALIDAS

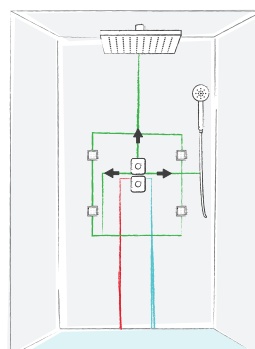

— COLD WATER // EAU FROIDE // AGUA FRIA
— HOT WATER // EAU CHAUDE // AGUA CALIENTE
— TEMPERATE WATER // EAU TEMPERÉE // AGUA TEMPLADA

KIT 3 OUTPUT // KIT 3 SORTIES // KIT 3 SALIDAS
KIT 11 PIECES // KIT 11 PIÈCES // KIT 11 PIEZAS

CHROME // CHROMÉ
CROMADO

WALL SHOWER HEAD ULTRA SLIM SELECTION
DOUCHES MURALES ULTRA SLIM SELECTION
ROCIADORES DUCHA ULTRA SLIM SELECCIÓN

STAINLESS STEEL AISI 304
ACIER INOX AISI 304
ACERO INOXIDABLE AISI 304

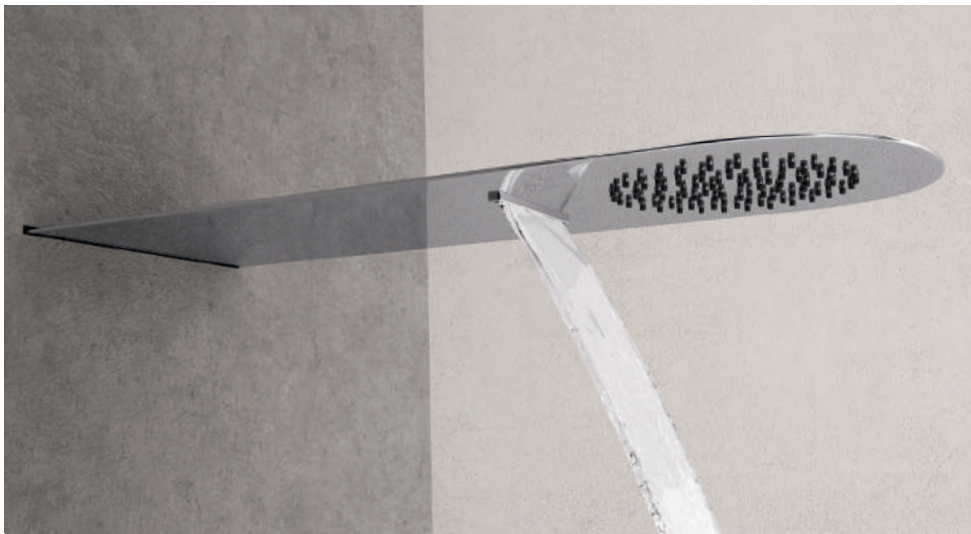

SHOWERS WITH WATERFALL

Shower with two water inlets so that the user could choose between the shower or cascade mode.

DOUCHES AVEC CASCADE

Douche avec deux entrées d'eau afin que l'utilisateur puisse choisir entre la douche ou le mode cascade.

DUCHAS CON CASCADE

Ducha con dos entradas de agua para que el usuario elija entre la ducha o el modo de cascada.

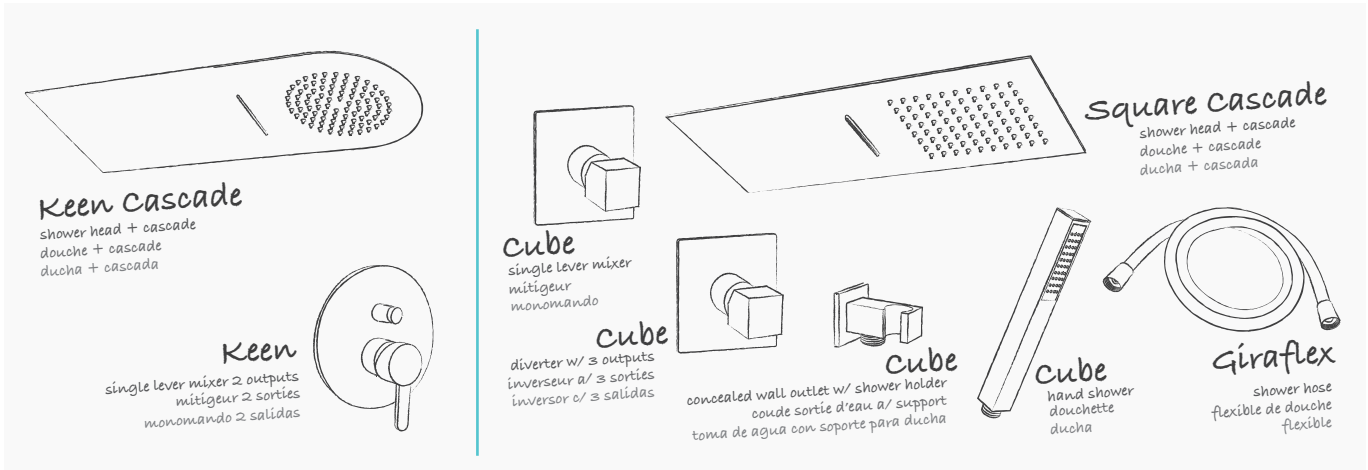

KEEN

WALL SHOWER HEAD ULTRA SLIM // DOUCHE MURALE ULTRA SLIM // ROCIADOR DUCHA ULTRA SLIM

220 X 550 MM	SHOWER HEAD Ø170 MM DOUCHE Ø170 MM DUCHA Ø170 MM	STAINLESS STEEL ACIER INOX ACERO INOXIDABLE
--------------	--	---

AISI 304



KEEN CASCADE

WALL SHOWER HEAD ULTRA SLIM // DOUCHE MURALE ULTRA SLIM // ROCIADOR DUCHA ULTRA SLIM

220 X 550 MM	SHOWER HEAD Ø170 MM + CASCADE 140 MM DOUCHE Ø170 MM + CASCADE 140 MM DUCHA Ø170 MM + CASCADA 140 MM	STAINLESS STEEL ACIER INOX ACERO INOXIDABLE
--------------	---	---

AISI 304



SQUARE

WALL SHOWER HEAD ULTRA SLIM // DOUCHE MURALE ULTRA SLIM // ROCIADOR DUCHA ULTRA SLIM

220 X 550 MM	SHOWER HEAD 140 X 210 MM DOUCHE 140 X 210 MM DUCHA 140 X 210 MM	STAINLESS STEEL ACIER INOX ACERO INOXIDABLE
--------------	---	---

AISI 304



SQUARE CASCADE

WALL SHOWER HEAD ULTRA SLIM // DOUCHE MURALE ULTRA SLIM // ROCIADOR DUCHA ULTRA SLIM

220 X 550 MM	SHOWER HEAD 150 X 150 MM + CASCADE 140 MM DOUCHE 150 X 150 MM + CASCADE 140 MM DUCHA 150 X 150 MM + CASCADA 140 MM	STAINLESS STEEL ACIER INOX ACERO INOXIDABLE
--------------	--	---

AISI 304

STAINLESS STEEL AISI 304
ACIER INOX AISI 304
ACERO INOXIDABLE AISI 304

BUILT-IN SHOWER HEAD ULTRA SLIM SELECTION
DOUCHES DE PLAFOND ENCASTRÉE ULTRA SLIM SELECTION
ROCIADORES EMPOTRADO ULTRA SLIM SELECCIÓN



CUBE

BUILT-IN SHOWER HEAD ULTRA SLIM
DOUCHE DE PLAFOND ENCASTRÉE ULTRA SLIM
ROCIADOR EMPOTRADO ULTRA SLIM

300 X 300 MM
400 X 400 MM
500 X 500 MM

STAINLESS STEEL
ACIER INOX
ACERO INOXIDABLE

AISI 304



ROUND

BUILT-IN SHOWER HEAD ULTRA SLIM
DOUCHE DE PLAFOND ENCASTRÉE ULTRA SLIM
ROCIADOR EMPOTRADO ULTRA SLIM

Ø300 MM
Ø400 MM
Ø500 MM

STAINLESS STEEL
ACIER INOX
ACERO INOXIDABLE

AISI 304



EDGE

BUILT-IN SHOWER HEAD ULTRA SLIM
DOUCHE DE PLAFOND ENCASTRÉE ULTRA SLIM
ROCIADOR EMPOTRADO ULTRA SLIM

400 X 600 MM

STAINLESS STEEL
ACIER INOX
ACERO INOXIDABLE

AISI 304

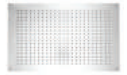

STAINLESS STEEL AISI 304
ACIER INOX AISI 304
ACERO INOXIDABLE AISI 304

SHOWER HEAD ULTRA SLIM SELECTION
DOUCHES DE PLAFOND ULTRA SLIM SELECTION
ROCIADORES ULTRA SLIM SELECCIÓN



SQUARE

SHOWER HEAD ULTRA SLIM
DOUCHE DE PLAFOND ULTRA SLIM
ROCIADOR ULTRA SLIM

200 X 200 MM
250 X 250 MM
300 X 300 MM
400 X 400 MM

STAINLESS STEEL
ACIER INOX
ACERO INOXIDABLE

AISI 304

ROUND

SHOWER HEAD ULTRA SLIM
DOUCHE DE PLAFOND ULTRA SLIM
ROCIADOR ULTRA SLIM

Ø200 MM
Ø250 MM
Ø300 MM
Ø400 MM

STAINLESS STEEL
ACIER INOX
ACERO INOXIDABLE

AISI 304

EDGE

SHOWER HEAD ULTRA SLIM
DOUCHE DE PLAFOND ULTRA SLIM
ROCIADOR ULTRA SLIM

300 X 200 MM

STAINLESS STEEL
ACIER INOX
ACERO INOXIDABLE

AISI 304

BRASS
LAITON
LATÓN

SHOWER HEAD
DOUCHES DE PLAFOND
ROCIADORES

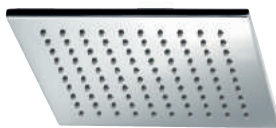

CUBE

SHOWER HEAD // DOUCHE DE PLAFOND // ROCIADOR

200 X 200 MM
300 X 300 MM
400 X 400 MM
500 X 500MM

BRASS
LAITON
LATÓN

CHROME // CHROMÉ
CROMADO

CITY

SHOWER HEAD // DOUCHE DE PLAFOND // ROCIADOR

Ø200 MM
Ø300 MM
Ø400 MM
Ø500 MM

BRASS
LAITON
LATÓN

CHROME // CHROMÉ
CROMADO

PIK

SHOWER HEAD // DOUCHE DE PLAFOND // ROCIADOR

Ø250 MM

BRASS
LAITON
LATÓN

CHROME // CHROMÉ
CROMADO

ABS

SHOWER HEAD
DOUCHES DE PLAFOND
ROCIADORES



EDGE

SHOWER HEAD
DOUCHE DE PLAFOND // ROCIADOR

230 X 230 MM ABS

CHROME // CHROMÉ
CROMADO

CUBE

SHOWER HEAD
DOUCHE DE PLAFOND // ROCIADOR

200 X 200 MM ABS

CHROME // CHROMÉ
CROMADO

TIP

SHOWER HEAD
DOUCHE DE PLAFOND // ROCIADOR

Ø240 MM ABS

CHROME // CHROMÉ
CROMADO

CITY

SHOWER HEAD
DOUCHE DE PLAFOND // ROCIADOR

Ø200 MM ABS

CHROME // CHROMÉ
CROMADO

CONCEALED SHOWER SINGLE LEVER MIXER 1 OUTPUT
MITIGEUR À ENCASTRER 1 SORTIE
MONOMANDOS EMPOTRADOS 1 SALIDA



KEEN

SIMPLE
SIMPLE
SIMPLE

CHROME // CHROMÉ
CROMADO



CITY

SIMPLE
SIMPLE
SIMPLE

CHROME // CHROMÉ
CROMADO



CILIN

SIMPLE
SIMPLE
SIMPLE

CHROME // CHROMÉ
CROMADO



PIXEL

SIMPLE
SIMPLE
SIMPLE

CHROME // CHROMÉ
CROMADO



PRISMA

SIMPLE
SIMPLE
SIMPLE

CHROME // CHROMÉ
CROMADO



CUBE

SIMPLE
SIMPLE
SIMPLE

CHROME // CHROMÉ
CROMADO

CONCEALED SHOWER DIVERTER 2 OR 3 OUTPUTS
DÉVIATEUR À ENCASTRER 2 OU 3 SORTIES
INVERSOR 2 O 3 SALIDAS



CITY

2 OUTPUTS
2 SORTIES
2 SALIDAS

3 OUTPUTS
3 SORTIES
3 SALIDAS

CHROME // CHROMÉ
CROMADO



CUBE

2 OUTPUTS
2 SORTIES
2 SALIDAS

3 OUTPUTS
3 SORTIES
3 SALIDAS

CHROME // CHROMÉ
CROMADO

CONCEALED SHOWER SINGLE LEVER MIXER 2 OUTPUTS
MITIGEUR À ENCASTRER 2 SORTIES
MONOMANDOS EMPOTRADOS 2 SALIDAS



KEEN

WITH DIVERTER
AVEC INVERSEUR
CON INVERSOR

CHROME // CHROMÉ
CROMADO



CITY

WITH DIVERTER
AVEC INVERSEUR
CON INVERSOR

CHROME // CHROMÉ
CROMADO



CILIN

WITH DIVERTER
AVEC INVERSEUR
CON INVERSOR

CHROME // CHROMÉ
CROMADO



PIXEL

WITH DIVERTER
AVEC INVERSEUR
CON INVERSOR

CHROME // CHROMÉ
CROMADO



PRISMA

WITH DIVERTER
AVEC INVERSEUR
CON INVERSOR

CHROME // CHROMÉ
CROMADO



CUBE

WITH DIVERTER
AVEC INVERSEUR
CON INVERSOR

CHROME // CHROMÉ
CROMADO

CONCEALED THERMOSTATIC SHOWER MIXER
THERMOSTATIC À ENCASTRER
THERMOSTÁTICO EMPOTRADO



TEMPER

SIMPLE
SIMPLE
SIMPLE

CHROME // CHROMÉ
CROMADO



TEMPER

2 OUTPUTS
2 SORTIES
2 SALIDAS

CHROME // CHROMÉ
CROMADO



TEMPER

3 OUTPUTS
3 SORTIES
3 SALIDAS

CHROME // CHROMÉ
CROMADO



TEMPER

4 OUTPUTS
4 SORTIES
4 SALIDAS

CHROME // CHROMÉ
CROMADO

SHOWER ARMS
BRAS DE DOUCHE
SOPORTES PARA ROCIADORES



CUBE

SHOWER ARM // BRAS DE DOUCHE // SOPORTE A PARED

30 CM

40 CM

CHROME // CHROMÉ
CROMADO



CILIN

SHOWER ARM // BRAS DE DOUCHE // SOPORTE A PARED

30 CM

40 CM

CHROME // CHROMÉ
CROMADO



CUBE

CEILING SHOWER ARM // BRAS DE DOUCHE AU PLAFOND // SOPORTE A TECHO

20 CM

CHROME // CHROMÉ
CROMADO

CILIN

CEILING SHOWER ARM // BRAS DE DOUCHE AU PLAFOND // SOPORTE A TECHO

20 CM

30 CM

CHROME // CHROMÉ
CROMADO

BODY JETS
DOUCHETTES LATÉRALES
JET DE DUCHA



CUBE

BODY JET // DOUCHETTE LATÉRALE // JET DE DUCHA

3,5 X 3,5 CM

CHROME // CHROMÉ
CROMADO



CILIN

BODY JET // DOUCHETTE LATÉRALE // JET DE DUCHA

Ø3,5 CM

CHROME // CHROMÉ
CROMADO

CONCEALED SPOUTS
BEC À ENCASTRER
CAÑO EMPOTRADO



CUBE

SPOUT // BEC // CAÑO

18 CM - BRASS

18 CM - LAITON

18 CM - LATÓN

CHROME // CHROMÉ
CROMADO



CILIN

SPOUT // BEC // CAÑO

18 CM - BRASS

18 CM - LAITON

18 CM - LATÓN

CHROME // CHROMÉ
CROMADO

CONCEALED WALL OUTLETS
COUDES SORTIE D'EAU À ENCASTRER
TOMAS DE AGUA



CUBE

CONCEALED WALL OUTLET // COUDE SORTIE D'EAU // TOMA DE AGUA

WITH SHOWER HOLDER
AVEC SUPPORT
CON SOPORTE PARA DUCHA

CHROME // CHROMÉ
CROMADO



CILIN

CONCEALED WALL OUTLET // COUDE SORTIE D'EAU // TOMA DE AGUA

WITH SHOWER HOLDER
AVEC SUPPORT
CON SOPORTE PARA DUCHA

CHROME // CHROMÉ
CROMADO



CUBE

CONCEALED WALL OUTLET // COUDE SORTIE D'EAU // TOMA DE AGUA

WITHOUT SHOWER HOLDER
SANS SUPPORT
SIN SOPORTE PARA DUCHA

CHROME // CHROMÉ
CROMADO



CILIN

CONCEALED WALL OUTLET // COUDE SORTIE D'EAU // TOMA DE AGUA

WITHOUT SHOWER HOLDER
SANS SUPPORT
SIN SOPORTE PARA DUCHA

CHROME // CHROMÉ
CROMADO



CITY

CONCEALED WALL OUTLET // COUDE SORTIE D'EAU // TOMA DE AGUA

WITHOUT SHOWER HOLDER
SANS SUPPORT
SIN SOPORTE PARA DUCHA

CHROME // CHROMÉ
CROMADO



PILLAR ADAPTER // COLONNETTE POUR MITIGEUR // COLUMNNA

FOR BATH MIXER ADAPTER
POUR APPLICATION MITIGEUR BAIGNOIRE
PARA APLICACIÓN DE MONOMANDO EN BAÑERA

CHROME // CHROMÉ
CROMADO

BATHTUB SYSTEMS
SYSTÈME DE BAIGNOIRE
SISTEMA PARA BAÑERA



CITY

CONCEALED BATH
BAIGNOIRE À ENCASTRER // BAÑERA EMPOTRADA

MIXER WITH DIVERTER
MITIGEUR AVEC INVERSEUR
MONOMANDO CON INVERSOR

CHROME // CHROMÉ
CROMADO



CILIN

3 HOLES BATH
BAIGNOIRE 3 TROUS // BAÑERA EMPOTRADA

MIXER WITH DIVERTER
MITIGEUR AVEC INVERSEUR
MONOMANDO CON INVERSOR

CHROME // CHROMÉ
CROMADO



CITY

3 HOLES BATH
BAIN 3 TROUS // BAÑERA 3 AGUJEROS

MIXER WITH DIVERTER
MITIGEUR AVEC INVERSEUR
MONOMANDO CON INVERSOR

CHROME // CHROMÉ
CROMADO



CILIN

3 HOLES BATH
BAIN 3 TROUS // BAÑERA 3 AGUJEROS

MIXER WITH DIVERTER
MITIGEUR AVEC INVERSEUR
MONOMANDO CON INVERSOR

CHROME // CHROMÉ
CROMADO

MASSAGE HAND SHOWERS
DOUCHETTE DE MASSAGE
DUCHAS DE MASAJE

HAND SHOWERS
DOUCHETTE
DUCHAS

SHOWER HOLDER
SUPPORT DE DOUCHE
SOPORTE PARA DUCHA



GLAM
HAND SHOWER // DOUCHETTE // DUCHA
2 POSITIONS
2 FONCTIONS // 2 FUNCIONES

ABS

CHROME // CHROMÉ
CROMADO



CUBE
HAND SHOWER // DOUCHETTE // DUCHA

BRASS
LAITON
LATÓN

CHROME // CHROMÉ
CROMADO



TIP
HAND SHOWER // DOUCHETTE // DUCHA

ABS

CHROME // CHROMÉ
CROMADO



CUBE
SHOWER HOLDER
SUPPORT DE DOUCHE // SOPORTE PARA DUCHA

BRASS
LAITON
LATÓN

CHROME // CHROMÉ
CROMADO



MAX
HAND SHOWER // DOUCHETTE // DUCHA
3 POSITIONS
3 FONCTIONS // 3 FUNCIONES

ABS

CHROME // CHROMÉ
CROMADO



CUBE
HAND SHOWER // DOUCHETTE // DUCHA

ABS

CHROME // CHROMÉ
CROMADO



EDGE
HAND SHOWER // DOUCHETTE // DUCHA

ABS

CHROME // CHROMÉ
CROMADO



CUBE
SHOWER HOLDER
SUPPORT DE DOUCHE // SOPORTE PARA DUCHA

ABS

CHROME // CHROMÉ
CROMADO



SPARK
HAND SHOWER // DOUCHETTE // DUCHA
3 POSITIONS
3 FONCTIONS // 3 FUNCIONES

ABS

CHROME // CHROMÉ
CROMADO



CILIN
HAND SHOWER // DOUCHETTE // DUCHA

BRASS
LAITON
LATÓN

CHROME // CHROMÉ
CROMADO



SENSE
HAND SHOWER // DOUCHETTE // DUCHA

ABS

CHROME // CHROMÉ
CROMADO



CILIN
SHOWER HOLDER
SUPPORT DE DOUCHE // SOPORTE PARA DUCHA

BRASS
LAITON
LATÓN

CHROME // CHROMÉ
CROMADO



CILIN
HAND SHOWER // DOUCHETTE // DUCHA

ABS

CHROME // CHROMÉ
CROMADO



VINTAGE
HAND SHOWER // DOUCHETTE // DUCHA

BRASS
LAITON
LATÓN

CHROME // CHROMÉ
CROMADO



CILIN
SHOWER HOLDER
SUPPORT DE DOUCHE // SOPORTE PARA DUCHA

ABS

CHROME // CHROMÉ
CROMADO



GIRAFLEX
SHOWER HOSE // FLEXIBLES DE DOUCHE // FLEXIBLE

- 1.50 M
- 1.75 M
- 2.00 M

SILVER // ARGENT PLATA PROVIDED IN BOX // FOURNIT EN BOÎTE
SUMINISTRA EN CAJA

SHOWER HOSE
ANTI-TWIST SYSTEM

The Giraflex Ctesi® shower hoses are equipped with anti-twist system, causing it to be the smartest choice for those who want a pleasant shower and full comfort. For his coat, the Giraflex shower hoses are presented with a unique beauty while preventing the twist disrupt your shower or destroy your shower hose.

FLEXIBLES DOUCHE
AVEC SYSTÈME ANTI-TWIST

Les flexibles de douche Giraflex Ctesi® sont équipés avec système anti-torsion, amenant à être le meilleur choix pour ceux qui veulent une bonne douche dans tout confort. Pour son revêtement, les flexibles de douche Giraflex sont présentés avec une beauté unique, tout en empêchant que la torsion arrête votre douche ou de détruit votre flexible.

FLEXIBLES DE DUCHA
CON SISTEMA ANTI-TWIST

Los flexibles de ducha Giraflex de Ctesi® están equipados con sistema anti-giro, haciendo que sea la opción más inteligente para aquellos que quieren una buena ducha y todo el confort. Por su recubrimiento, los flexibles de ducha Giraflex se presentan con una belleza única evitando el giro deteña su ducha o que destruye el flexible.



EXTENDABLE W/ CONICAL NUT
EXTENSIBLE AVEC CONÛ // EXTENSIBLE C/ TUERCA CONICA
SHOWER HOSE // FLEXIBLES DE DOUCHE // FLEXIBLE

1.70 M » 2.20 M

GOLD // OR // ORO PROVIDED IN BOX // FOURNIT EN BOÎTE
SUMINISTRA EN CAJA



PVC
SHOWER HOSE // FLEXIBLES DE DOUCHE // FLEXIBLE

1.75 M

WHITE // BLANC BLANCO PROVIDED IN BOX // FOURNIT EN BOÎTE
SUMINISTRA EN CAJA



EXTENDABLE W/ CHROME CONICAL NUT
EXTENSIBLE A/ CONÛ CHROMÛ // EXTENSIBLE C/ TUERCA CONICA CROMADO
SHOWER HOSE // FLEXIBLES DE DOUCHE // FLEXIBLE

1.70 M » 2.20 M

CHROME // CHROMÛ CROMADO



WITH CONICAL NUT // AVEC CONÛ // CON TUERCA CONICA
SHOWER HOSE // FLEXIBLES DE DOUCHE // FLEXIBLE

- 1.25 M
- 1.50 M
- 1.75 M
- 2.00 M

CHROME // CHROMÛ CROMADO



SIMPLE
SHOWER HOSE // FLEXIBLES DE DOUCHE // FLEXIBLE

- 1.25 M
- 1.50 M
- 1.75 M
- 2.00 M

CHROME // CHROMÛ CROMADO

SLIDING RAILS
BARRES DE DOUCHE
BARRA PARA LA DUCHA



CUBE

SLIDING RAIL // BARRE DE DOUCHE // BARRA PARA LA DUCHA

BRASS
 LAITON
 LATÓN

CHROME // CHROMÉ
 CROMADO



RUBY

SLIDING RAIL // BARRE DE DOUCHE // BARRA PARA LA DUCHA

BRASS
 LAITON
 LATÓN

CHROME // CHROMÉ
 CROMADO



LINEA

SLIDING RAIL // BARRE DE DOUCHE // BARRA PARA LA DUCHA

ABS

CHROME // CHROMÉ
 CROMADO



CILIN

SLIDING RAIL // BARRE DE DOUCHE // BARRA PARA LA DUCHA

BRASS
 LAITON
 LATÓN

CHROME // CHROMÉ
 CROMADO



SKY

SLIDING RAIL // BARRE DE DOUCHE // BARRA PARA LA DUCHA

ABS

CHROME // CHROMÉ
 CROMADO



STAR

SLIDING RAIL // BARRE DE DOUCHE // BARRA PARA LA DUCHA

ABS

CHROME // CHROMÉ
 CROMADO

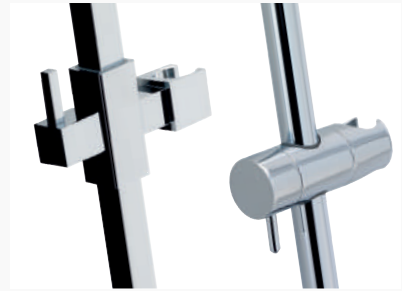

SHOWER SLIDING RAILS

The range of Ctesi® shower sliding rails that we present you on this page provide more comfort to your shower space while contributing to an aesthetic improvement, transforming in a simple way your shower in a more clear and practical space for everyday use.

BARRES DE DOUCHE

La gamme de Ctesi® barres de douche que nous vous présentons sur cette page fournissent plus de confort à votre espace de douche tout en contribuant à une amélioration esthétique, transformant simplement votre douche dans un espace plus clair et pratique pour une utilisation quotidienne.

BARRAS DE DUCHA

La gama de barras de ducha Ctesi® que presentamos en esta página proporcionan mayor comodidad a su espacio de ducha al tiempo que contribuyen a una mejora estética, transformando simplemente su ducha en un espacio más claro y práctico para el uso diario.



SPRING

SLIDING RAIL // BARRE DE DOUCHE // BARRA PARA LA DUCHA

ABS

CHROME // CHROMÉ
 CROMADO



MORE COMFORT MORE HYGIENE

The Shut-Off Handshower give you more comfort in your personal hygiene and are indicated to replace bidets when applied near the toilet.

They can be connected to a water point with an angle valve and acts 2 waters when a water mixing valve is applied before the shut-off. There are also alternative applications, such as for example the application in pet shops or similar places for the hygiene of your pet.

Maximum hygiene and comfort in a model that stands for excellence of their performance.

PLUS DE CONFORT PLUS D'HYGIENE

Les douchettes hygiéniques BMK vous donne plus de confort dans votre hygiène personnelle et sont indiqués pour remplacer les quand ils sont appliqués près des toilettes.

Ils peuvent être connectés à un point d'eau avec robinet d'equerre et compris 2 eaux lorsqu'une mélangeur d'eau est appliquée avant la douchette. Il existe également d'autres applications, comme par exemple pour l'hygiène de votre animal de compagnie. Hygiène maximale et confort dans un modèle qui représente l'excellence de leur performance.

MÁS COMODIDAD MÁS HIGIENE

Las duchetas higiénicas le dan más comodidad en su higiene personal y están indicadas para reemplazar el bidé cuando se aplican junto al inodoro. Pueden estar conectadas a un punto de toma de agua o mismo con 2 aguas cuando se aplica una válvula mezcladora antes de la ducheta.

También existen aplicaciones alternativas, como por ejemplo la aplicación en Pet Shops o lugares similares para la higiene de su mascota.



Brass Hygienic Shower with shower holder with flexible 125 CM

Douchette Hygiénique Laton avec support avec flexible 125 CM

Ducha Higiénica Latón con soporte con flexible 125 CM

STATUS

BRASS HYGIENIC SHOWER // DOUCHETTE HYGIÉNIQUE LAITON // DUCHA HIGIÉNICA LATÓN

SIMPLE
SIMPLE
SIMPLE

WITH ANGLE VALVE
AVEC ROBINETS ÉQUERRE
CON GRIFO DE PASO ANGULAR

CHROME // CHROMÉ
CROMADO

PROVIDED IN BOX // FOURNIT EN BOÎTE
SUMINISTRA EN CAJA



ABS Hygienic Shower with shower holder with flexible 125 CM

Douchette Hygiénique ABS avec support avec flexible 125 CM

Ducha Higiénica ABS con soporte con flexible 125 CM

TIVOLI

ABS HYGIENIC SHOWER // DOUCHETTE HYGIÉNIQUE ABS // DUCHA HIGIÉNICA ABS

SIMPLE
SIMPLE
SIMPLE

WITH ANGLE VALVE
AVEC ROBINETS ÉQUERRE
CON GRIFO DE PASO ANGULAR

CHROME // CHROMÉ
CROMADO

PROVIDED IN BOX // FOURNIT EN BOÎTE
SUMINISTRA EN CAJA



TREVI

Brass Hygienic Shower with shower holder with flexible 125 CM

Douchette Hygiénique Laton avec support avec flexible 125 CM

Ducha Higiénica Latón con soporte con flexible 125 CM



SIMPLE
SIMPLE
SIMPLE

WITH ANGLE VALVE
AVEC ROBINETS ÉQUERRE
CON GRIFO DE PASO ANGULAR

CHROME // CHROMÉ
CROMADO

PROVIDED IN BOX // FOURNIT EN BOÎTE
SUMINISTRA EN CAJA



TAPS THERMOSTATIC

A thermostatic tap always keep the same water temperature throughout your shower. This is why a more secure, comfortable solution and allows you a huge saving water in your shower.

Adjust in advance and precisely the desired temperature for your water and keep this temperature throughout your shower. Thus, we give you the maximum pleasure in the shower, avoiding the risk of burns caused by too hot water while reducing the resulting water waste from the time it takes to temper the water to your liking.



ROBINETS THERMOSTATIQUES

Un robinet thermostatique maintient toujours la même température de l'eau tout au long de votre douche. C'est pour cela plus sûr, confortable et permet à vous même un énorme économie d'eau dans votre douche.

Réglez d'avance et avec précision la température souhaitée pour votre eau et gardez cette température tout au long de votre douche. Ainsi, nous vous offrons le maximum de plaisir dans la douche, ce qui évite les risques de brûlure de l'eau trop chaude en réduisant le gaspillage de l'eau résultant du temps qu'il faut pour tempérer l'eau à votre goût.



GRIFERÍA THERMOSTÁTICA

Un grifo termostático siempre mantiene la misma temperatura del agua a lo largo de su ducha. Esta es la razón por un entorno más seguro, cómodo y que incluso permite un enorme ahorro de agua en la ducha.

Fije de antemano y con precisión la temperatura deseada para el agua y mantéñala esta temperatura a lo largo de su ducha. Por lo tanto, le damos el máximo placer en la ducha, evitando el riesgo de quemaduras con agua demasiado caliente mientras se reduce el desperdicio de agua que resulta de tiempo que se necesita para templar el agua a su gusto.



Confort

Increase or decrease the flow, always ensuring the same temperature.

Confort

Augmentez ou diminuez le débit d'eau, en garantissant toujours la même température.

Confort

Aumente o disminuya el caudal, asegurando siempre la misma temperatura.

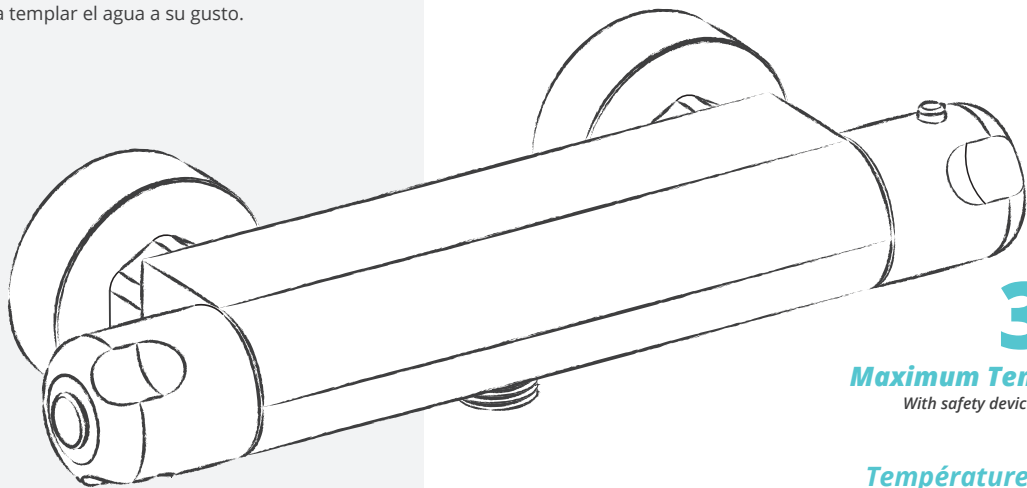

38°C

Maximum Temperature

With safety device to prevent water exceeds 38°C.

Température Maximale

Avec dispositif de sécurité pour empêcher que l'eau dépasse 38°C.

Temperatura máxima

Con dispositivo de seguridad para evitar que el agua supere los 38 °C.

Desired Temperature

Enjoy your shower at the desired temperature, always constant, even when another tap from your house is used.

Temperature Désiré

Profitez de votre douche à la température souhaitée, toujours constante, même si un autre robinet de votre maison est utilisé.

Temperatura deseada

Disfrute de su ducha a la temperatura deseada, siempre constante, incluso cuando se utiliza otro grifo de su vivienda.



Safety

Save energy while ensuring the safety and the shower comfort from of your entire family.

Sécurité

Économisez de l'énergie tout en assurant la sécurité et le confort de la douche de toute votre famille.

Seguridad

Ahorre energía garantizando la seguridad y la comodidad de la ducha de toda su familia.



FOCUS

BATH // BAIGNOIRE // BAÑERA

THERMOSTATIC MIXER // MITIGEUR THERMOSTATIC // MEZCLADOR THERMOSTÁTICO

ABS KIT ACCESSORIES + SHOWER HOSE

KIT ACCESSOIRES ABS + FLEXIBLE DE DOUCHE

SET ACCESORIOS EN ABS + FLEXIBLE

CHROME // CHROMÉ
CROMADO



FOCUS

SHOWER // DOUCHE // DUCHA

THERMOSTATIC MIXER // MITIGEUR THERMOSTATIC // MEZCLADOR THERMOSTÁTICO

ABS KIT ACCESSORIES + SHOWER HOSE

KIT ACCESSOIRES ABS + FLEXIBLE DE DOUCHE

SET ACCESORIOS EN ABS + FLEXIBLE

CHROME // CHROMÉ
CROMADO





SQUARE

BATH // BAIGNOIRE // BAÑERA

THERMOSTATIC MIXER // MITIGEUR THERMOSTATIC // MEZCLADOR TERMOSTÁTICO

BRASS KIT ACCESSORIES + GIRAFLEX SHOWER HOSE
 KIT ACCESSOIRES LAITON + FLEXIBLE DE DOUCHE GIRAFLEX
 SET ACCESORIOS EN LATÓN + FLEXIBLE GIRAFLEX

ABS KIT ACCESSORIES + GIRAFLEX SHOWER HOSE
 KIT ACCESSOIRES ABS + FLEXIBLE DE DOUCHE GIRAFLEX
 SET ACCESORIOS EN ABS + FLEXIBLE GIRAFLEX

CHROME // CHROMÉ
 CROMADO



SQUARE

SHOWER // DOUCHE // DUCHA

THERMOSTATIC MIXER // MITIGEUR THERMOSTATIC // MEZCLADOR TERMOSTÁTICO

BRASS KIT ACCESSORIES + GIRAFLEX SHOWER HOSE
 KIT ACCESSOIRES LAITON + FLEXIBLE DE DOUCHE GIRAFLEX
 SET ACCESORIOS EN LATÓN + FLEXIBLE GIRAFLEX

ABS KIT ACCESSORIES + GIRAFLEX SHOWER HOSE
 KIT ACCESSOIRES ABS + FLEXIBLE DE DOUCHE GIRAFLEX
 SET ACCESORIOS EN ABS + FLEXIBLE GIRAFLEX

CHROME // CHROMÉ
 CROMADO



ROUND

BATH // BAIGNOIRE // BAÑERA

THERMOSTATIC MIXER // MITIGEUR THERMOSTATIC // MEZCLADOR TERMOSTÁTICO

BRASS KIT ACCESSORIES + GIRAFLEX SHOWER HOSE
 KIT ACCESSOIRES LAITON + FLEXIBLE DE DOUCHE GIRAFLEX
 SET ACCESORIOS EN LATÓN + FLEXIBLE GIRAFLEX

ABS KIT ACCESSORIES + GIRAFLEX SHOWER HOSE
 KIT ACCESSOIRES ABS + FLEXIBLE DE DOUCHE GIRAFLEX
 SET ACCESORIOS EN ABS + FLEXIBLE GIRAFLEX

CHROME // CHROMÉ
 CROMADO



ROUND

SHOWER // DOUCHE // DUCHA

THERMOSTATIC MIXER // MITIGEUR THERMOSTATIC // MEZCLADOR TERMOSTÁTICO

BRASS KIT ACCESSORIES + GIRAFLEX SHOWER HOSE
 KIT ACCESSOIRES LAITON + FLEXIBLE DE DOUCHE GIRAFLEX
 SET ACCESORIOS EN LATÓN + FLEXIBLE GIRAFLEX

ABS KIT ACCESSORIES + GIRAFLEX SHOWER HOSE
 KIT ACCESSOIRES ABS + FLEXIBLE DE DOUCHE GIRAFLEX
 SET ACCESORIOS EN ABS + FLEXIBLE GIRAFLEX

CHROME // CHROMÉ
 CROMADO



UNI UNIVERSAL UNIVERSELLE UNIVERSAL

Practical and stylish, the UNI columns adapt to any existing mixer in your bath space.

Pratique et élégant, les colonnes UNI s'adaptent à tout mélangeur existant dans votre espace de bain.

Prácticos y con estilo, las columnas UNI se adaptan a cualquier mezclador existente en su espacio de baño.

- Brass extensible column
- Brass mount fittings
- Quick diverter (ceramic cartridge)
- Colonne extensible en laiton
- Fixation en laiton
- Inverseur rapide (cartouche céramique)
- Columna extensible latón
- Accesorios de montaje en latón
- Desviador rápido (cartucho de cerámica)

EXTENSIBLE

The rod is easily adjustable to the desire height, max. 50 cm.

La tige est facilement ajustable à la hauteur désirée, máx. 50 cm.

La barra es fácilmente ajustable a la altura deseada, máx. 50 cm.

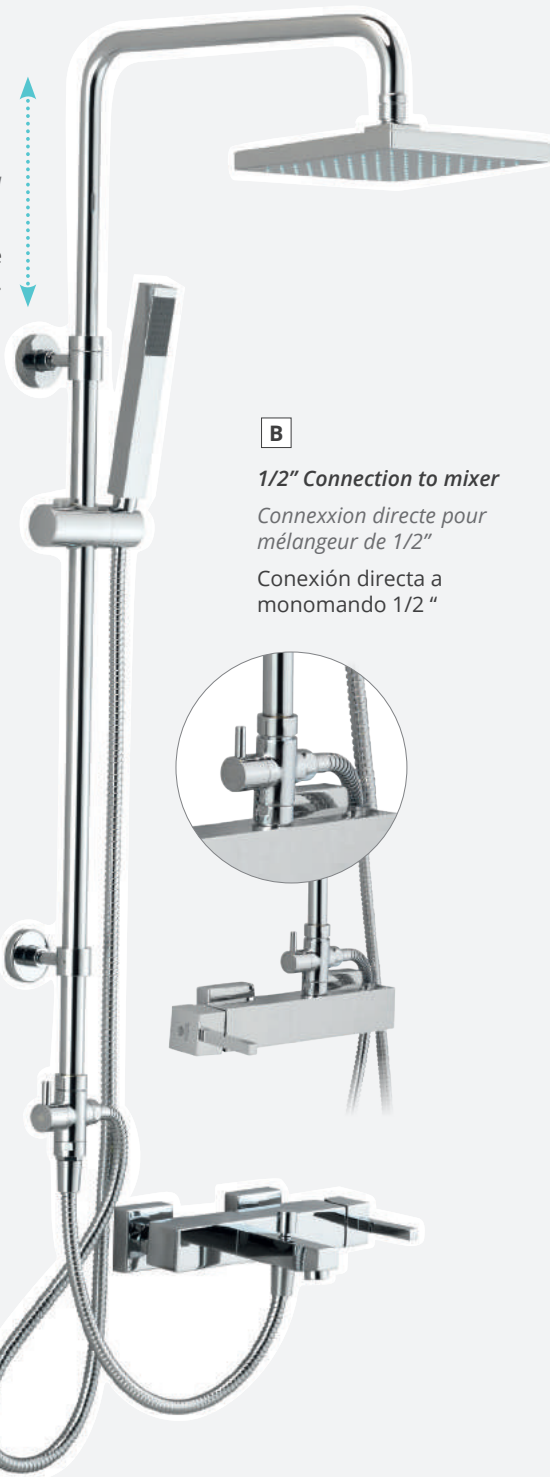

A

1/2" Connection
Connexion 1/2"
Conexión 1/2"



B

1/2" Connection to mixer
Connexion directe pour mélangeur de 1/2"
Conexión directa a monomando 1/2"



UNIVERSAL CONNECTION
CONNEXION UNIVERSELLE
CONEXIÓN UNIVERSAL



UNISQUARE

SHOWER HEAD 20 X 20CM // POMME DE DOUCHE 20 X 20CM // ROCIADOR 20 X 20 CM

- | | |
|----------|---|
| A | KIT WITH ABS SHOWER
KIT AVEC DOUCHETTE ABS
SET CON DUCHA ABS |
| | KIT WITH BRASS SHOWER
KIT AVEC DOUCHETTE LAITON
SET CON DUCHA LATÓN |
| B | KIT WITH ABS SHOWER
KIT AVEC DOUCHETTE ABS
SET CON DUCHA ABS |
| | KIT WITH BRASS SHOWER
KIT AVEC DOUCHETTE LAITON
SET CON DUCHA LATÓN |
- CHROME // CHROMÉ
CROMADO



UNIROUND

SHOWER HEAD Ø20CM // POMME DE DOUCHE Ø20CM // ROCIADOR Ø20CM

- | | |
|----------|---|
| A | KIT WITH ABS SHOWER
KIT AVEC DOUCHETTE ABS
SET CON DUCHA ABS |
| | KIT WITH BRASS SHOWER
KIT AVEC DOUCHETTE LAITON
SET CON DUCHA LATÓN |
| B | KIT WITH ABS SHOWER
KIT AVEC DOUCHETTE ABS
SET CON DUCHA ABS |
| | KIT WITH BRASS SHOWER
KIT AVEC DOUCHETTE LAITON
SET CON DUCHA LATÓN |
- CHROME // CHROMÉ
CROMADO

THERMO SENSE

COMPLETE SHOWER KIT WITH COLUMN AND THERMOSTATIC MIXER
KIT COMPLET DE COLONNE DE DOUCHE ET THERMOSTATIQUE MÉLANGEUR
KIT COMPLETO CON COLUMNA DE DUCHA Y MEZCLADOR TERMOSTÁTICO



EASY CLEANING

Anti-lime system that simplifies the removal of limescale from the head or hand shower.

NETTOYAGE FACILE

Système anti-calcaire qui facilite l'élimination des dépôts de calcaire dans la pomme de douche ou la douchette.

FÁCIL LIMPIEZA

Sistema anti-caliza que facilita la eliminación de los depósitos de cal en la ducha.

- Chrome brass column
- Chrome brass mount fittings
- Fixed shower ABS ø20 cm
- Thermostatic mixer
- Hand shower
- Chrome shower hose 1.50 m

- Colonne en laiton chromé
- Fixation en laiton chromé
- Pomme de douche en ABS ø20 cm
- Thermostatic mélangeur
- Douchette
- Flexible de douche chromé 1.50 m

- Columna de latón cromado
- Accesorios de montaje de latón cromado
- Rociador ø20 cm ABS
- Mezclador termostático
- Ducha de mano
- Flexible cromado 1.50 m

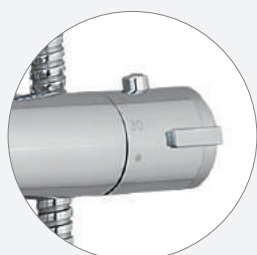

TEMPERATURE BLOCK

Safety mechanism that maintains a constant temperature of 38°, preventing burns.

BLOQUEUR DE TEMPÉRATURE

Mécanisme de sécurité que maintient une température constante de 38° évitant les brûlures.

TEMPERATURA ADECUADA

Mecanismo de seguridad que mantiene una temperatura constante de 38°, para la prevención de quemaduras.



DIVERTER

Simple and intuitive diverter integrated within the water opening and closing handle, allowing an easy selection between hand shower and head shower, further simplifying your bath.

INVERSEUR

Inverseur simple et intuitive intégrée au sein de l'ouverture et la poignée de fermeture eau, permettant une sélection aisée entre douchette et la pomme de douche, simplifiant encore votre douche.

DESVIADOR

Simple e intuitivo integrado dentro de la abertura del agua y asa de cierre, lo que permite una fácil selección entre ducha de mano y rociador, lo que simplifica aún más su baño.

THERMO SENSE

KIT WITH ABS SHOWER HAND
KIT AVEC DOUCHETTE ABS
SET CON DUCHA ABS

CHROME // CHROMÉ
CROMADO

BATH SERIES

Combine your taps and shower with Ctesi® bathroom accessories. Find clean and elegant lines allowing you to personalize your bathroom space and giving you the freedom to create your personal environment, so that you find beauty in every element present.

Combinez vos robinets et votre système de douche avec des accessoires offerts par Ctesi®. Lignes épurées de façons familiers qui personnalisent votre espace salle de bains. Vous avez la liberté de créer votre environnement de sorte que dans chaque détail vous trouvez la beauté particulière qui distingue la valeur de la sélection Bath Series.

Combine sus grifos y ducha con accesorios de baño Ctesi®. Encuentre líneas limpias y elegantes que le permiten personalizar su espacio de baño, dando la libertad para crear su entorno personal, de manera que pueda encontrar la belleza en cada elemento presente en su baño



STRAW



TOWEL HOLDER
PORTE-SERVETTE // TOALLERO

30 CM

45 CM

60 CM

CHROME // CHROMÉ
CROMADO

BRASS // LAITON
LATÓN



HOOK // PATÈRE // PERCHA

CHROME // CHROMÉ
CROMADO

BRASS // LAITON
LATÓN



TOILET PAPER HOLDER
PORTE-PAPIER // PORTARROLLOS

CHROME // CHROMÉ
CROMADO

BRASS // LAITON
LATÓN



TOILET BRUSH
PORTE-BALAIS // ESCOBILLERO

CHROME // CHROMÉ
CROMADO

BRASS // LAITON
LATÓN

SMOOTH



TOWEL HOLDER
PORTE-SERVETTE // TOALLERO

30 CM

45 CM

60 CM

CHROME // CHROMÉ
CROMADO

BRASS // LAITON
LATÓN



HOOK // PATÈRE // PERCHA

CHROME // CHROMÉ
CROMADO

BRASS // LAITON
LATÓN



TOILET PAPER HOLDER
PORTE-PAPIER // PORTARROLLOS

CHROME // CHROMÉ
CROMADO

BRASS // LAITON
LATÓN



TOILET BRUSH
PORTE-BALAIS // ESCOBILLERO

CHROME // CHROMÉ
CROMADO

BRASS // LAITON
LATÓN

FACE



TOWEL HOLDER
PORTE-SERVLETTE // TOALLERO

30 CM

45 CM

60 CM

CHROME // CHROMÉ
CROMADO

BRASS // LAITON
LATÓN



TOILET PAPER HOLDER
PORTE-PAPIER // PORTARROLLOS

CHROME // CHROMÉ
CROMADO

BRASS // LAITON
LATÓN



HOOK // PATÈRE // PERCHA

CHROME // CHROMÉ
CROMADO

BRASS // LAITON
LATÓN



TOILET BRUSH
PORTE-BALAIS // ESCOBILLERO

CHROME // CHROMÉ
CROMADO

BRASS // LAITON
LATÓN



PIXEL



TOWEL HOLDER
PORTE-SERVLETTE // TOALLERO

30 CM

45 CM

60 CM

CHROME // CHROMÉ
CROMADO

BRASS // LAITON
LATÓN



TOILET PAPER HOLDER
PORTE-PAPIER // PORTARROLLOS

CHROME // CHROMÉ
CROMADO

BRASS // LAITON
LATÓN



HOOK // PATÈRE // PERCHA

CHROME // CHROMÉ
CROMADO

BRASS // LAITON
LATÓN



TOILET BRUSH
PORTE-BALAIS // ESCOBILLERO

CHROME // CHROMÉ
CROMADO

BRASS // LAITON
LATÓN



SOAP DISH
PORTE-SAVON // JABONERA

CHROME // CHROMÉ
CROMADO

BRASS // LAITON
LATÓN



KEEN



TOWEL HOLDER
PORTE-SERVLETTE // TOALLERO

30 CM

45 CM

60 CM

CHROME // CHROMÉ
CROMADO

BRASS // LAITON
LATÓN



TOILET PAPER HOLDER
PORTE-PAPIER // PORTARROLLOS

CHROME // CHROMÉ
CROMADO

BRASS // LAITON
LATÓN



HOOK // PATÈRE // PERCHA

CHROME // CHROMÉ
CROMADO

BRASS // LAITON
LATÓN



TOILET BRUSH
PORTE-BALAIS // ESCOBILLERO

CHROME // CHROMÉ
CROMADO

BRASS // LAITON
LATÓN



NEXUS



TOWEL HOLDER
PORTE-SERVLETTE // TOALLERO

30 CM
45 CM
60 CM

CHROME // CHROMÉ CROMADO BRASS // LAITON LATÓN



TOILET PAPER HOLDER
PORTE-PAPIER // PORTARROLLOS

CHROME // CHROMÉ CROMADO BRASS // LAITON LATÓN



SOAP DISH // PORTE SAVON // JABONERA

CHROME // CHROMÉ CROMADO BRASS // LAITON LATÓN



HOOK // PATÈRE // PERCHA

CHROME // CHROMÉ CROMADO BRASS // LAITON LATÓN



TOILET BRUSH
PORTE-BALAIS // ESCOBILLERO

CHROME // CHROMÉ CROMADO BRASS // LAITON LATÓN



SPONGE BATH HOLDER
PORTE-EPONGE // CONTENEDOR DE REJILLA

CHROME // CHROMÉ CROMADO BRASS // LAITON LATÓN

VALLE



TOWEL HOLDER
PORTE-SERVLETTE // TOALLERO

30 CM
45 CM
60 CM

CHROME // CHROMÉ CROMADO BRASS // LAITON LATÓN



TOILET PAPER HOLDER
PORTE-PAPIER // PORTARROLLOS

CHROME // CHROMÉ CROMADO BRASS // LAITON LATÓN

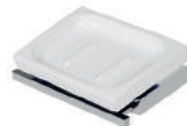

SOAP DISH // PORTE SAVON // JABONERA

CHROME // CHROMÉ CROMADO BRASS // LAITON LATÓN



HOOK // PATÈRE // PERCHA

CHROME // CHROMÉ CROMADO BRASS // LAITON LATÓN



TOILET BRUSH
PORTE-BALAIS // ESCOBILLERO

CHROME // CHROMÉ CROMADO BRASS // LAITON LATÓN



SPONGE BATH HOLDER
PORTE-EPONGE // CONTENEDOR DE REJILLA

CHROME // CHROMÉ CROMADO BRASS // LAITON LATÓN

MAR



TOWEL HOLDER
PORTE-SERVLETTE // TOALLERO

30 CM
45 CM
60 CM

CHROME // CHROMÉ CROMADO BRASS // LAITON LATÓN



TOILET PAPER HOLDER
PORTE-PAPIER // PORTARROLLOS

CHROME // CHROMÉ CROMADO BRASS // LAITON LATÓN

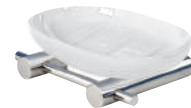

SOAP DISH // PORTE SAVON // JABONERA

CHROME // CHROMÉ CROMADO BRASS // LAITON LATÓN



HOOK // PATÈRE // PERCHA

CHROME // CHROMÉ CROMADO BRASS // LAITON LATÓN



TOILET BRUSH
PORTE-BALAIS // ESCOBILLERO

CHROME // CHROMÉ CROMADO BRASS // LAITON LATÓN

SKY



TOWEL HOLDER
PORTE-SERVIETTE // TOALLERO

45 CM
60 CM

CHROME // CHROMÉ
CROMADO



TOWEL RING
ANNEAU PORTE -SERVIETTE // TOALLERO DE ANILLA

CHROME // CHROMÉ
CROMADO



TOILET PAPER HOLDER
PORTE-PAPIER // PORTARROLLOS CON TAPA

CHROME // CHROMÉ
CROMADO



SOAP DISH // PORTE SAVON // JABONERA

CHROME // CHROMÉ
CROMADO



HOOK // PATÈRE // PERCHA

CHROME // CHROMÉ
CROMADO



GLASS HOLDER // PORTE-VERRE // PORTAVASO

CHROME // CHROMÉ
CROMADO

LIBERTY



TOWEL HOLDER
PORTE-SERVIETTE // TOALLERO

45 CM
60 CM

CHROME // CHROMÉ
CROMADO



TOWEL RING
ANNEAU PORTE -SERVIETTE // TOALLERO DE ANILLA

CHROME // CHROMÉ
CROMADO



TOILET PAPER HOLDER
PORTE-PAPIER // PORTARROLLOS CON TAPA

CHROME // CHROMÉ
CROMADO



SOAP DISH // PORTE SAVON // JABONERA

CHROME // CHROMÉ
CROMADO



HOOK // PATÈRE // PERCHA

CHROME // CHROMÉ
CROMADO



GLASS HOLDER // PORTE-VERRE // PORTAVASO

CHROME // CHROMÉ
CROMADO

MAXI



TOWEL HOLDER
PORTE-SERVIETTE // TOALLERO

45 CM
60 CM

CHROME // CHROMÉ
CROMADO



TOWEL RING
ANNEAU PORTE -SERVIETTE // TOALLERO DE ANILLA

CHROME // CHROMÉ
CROMADO



TOILET PAPER HOLDER
PORTE-PAPIER // PORTARROLLOS CON TAPA

CHROME // CHROMÉ
CROMADO



SOAP DISH // PORTE SAVON // JABONERA

CHROME // CHROMÉ
CROMADO



HOOK // PATÈRE // PERCHA

CHROME // CHROMÉ
CROMADO



GLASS HOLDER // PORTE-VERRE // PORTAVASO

CHROME // CHROMÉ
CROMADO



LEAN



TOWEL HOLDER
PORTE-SERVIETTE // TOALLERO

45 CM
60 CM

CHROME // CHROMÉ
CROMADO



DOUBLE TOWEL HOLDER
PORTE-SERVIETTE DOUBLE // TOALLERO DOBLE

60 CM

CHROME // CHROMÉ
CROMADO



TOWEL RING HOLDER
ANNEAU PORTE-SERVIETTE // TOALLERO DE ANILLA

CHROME // CHROMÉ
CROMADO



TOILET PAPER HOLDER
PORTE-PAPIER // PORTAROLLO

CHROME // CHROMÉ
CROMADO



HOOK // PATÈRE // PERCHA

CHROME // CHROMÉ
CROMADO



SOAP DISH
PORTE-SAVON // JABONERAS

CHROME // CHROMÉ
CROMADO



GLASS HOLDER // PORTE-VERRE // PORTAVASO

CHROME // CHROMÉ
CROMADO



TOILET BRUSH
PORTE BALAI // ESCOBILLERO

CHROME // CHROMÉ
CROMADO

SOAP DISPENSER
DISTRIBUTEUR SAVON
DOSIFICADOR DE JABÓN

CERAMIC // CÉRAMIQUE // PORCELANA

WHITE // BLANC
BLANCO

CHROME // CHROMÉ
CROMADO

SKY KIT



TOWEL HOLDERS // PORTE - SERVIETTES // TOALLEROS
45 CM / 60 CM



TOWEL RING HOLDER
ANNEAU PORTE - SERVIETTES
TOALLEROS DE ANILLA



TOILET PAPER HOLDER
PORTE - PAPIER
PORTARROLLO



HOOK // PATÈRE // PERCHA



KIT 1*
WITH SOAP DISH
AVEC PORTE-SAVON
CON JABONERA



KIT 2**
WITH GLASS HOLDER
AVEC PORTE-VERRE
CON PORTAVASO

KIT 1 TOWEL HOLDERS + TOILET PAPER HOLDER + HOOK + TOWEL RING HOLDER + SOAP DISH*
PORTE-SERVIETTES + PORTE- PAPIER + ANNEAU PORTE-SERVIETTES + PATÈRE + PORTE-SAVON*
TOALLEROS + PORTARROLLO + TOALLERO DE ANILLA + PERCHA + JABONERA*

KIT 2 TOWEL HOLDERS + TOILET PAPER HOLDER + HOOK + TOWEL RING HOLDER + GLASS HOLDER*
PORTE-SERVIETTES + PORTE- PAPIER + ANNEAU PORTE-SERVIETTES + PATÈRE + PORTE-VERRE*
TOALLEROS + PORTARROLLO + TOALLERO DE ANILLA + PERCHA + PORTAVASO*

CHROME // CHROME CROMADO  PROVIDED IN BOX // FOURNIT EN BOÎTE SUMINISTRA EN CAJA

LIBERTY KIT



TOWEL HOLDERS // PORTE - SERVIETTES // TOALLEROS
45 CM / 60 CM



TOWEL RING HOLDER
ANNEAU PORTE - SERVIETTES
TOALLEROS DE ANILLA



TOILET PAPER HOLDER
PORTE - PAPIER
PORTARROLLO



HOOK // PATÈRE // PERCHA



KIT 1*
WITH SOAP DISH
AVEC PORTE-SAVON
CON JABONERA



KIT 2**
WITH GLASS HOLDER
AVEC PORTE-VERRE
CON PORTAVASO

KIT 1 TOWEL HOLDERS + TOILET PAPER HOLDER + HOOK + TOWEL RING HOLDER + SOAP DISH*
PORTE-SERVIETTES + PORTE- PAPIER + ANNEAU PORTE-SERVIETTES + PATÈRE + PORTE-SAVON*
TOALLEROS + PORTARROLLO + TOALLERO DE ANILLA + PERCHA + JABONERA*

KIT 2 TOWEL HOLDERS + TOILET PAPER HOLDER + HOOK + TOWEL RING HOLDER + GLASS HOLDER*
PORTE-SERVIETTES + PORTE- PAPIER + ANNEAU PORTE-SERVIETTES + PATÈRE + PORTE-VERRE*
TOALLEROS + PORTARROLLO + TOALLERO DE ANILLA + PERCHA + PORTAVASO*

CHROME // CHROME CROMADO  PROVIDED IN BOX // FOURNIT EN BOÎTE SUMINISTRA EN CAJA

MAXI KIT



TOWEL HOLDERS // PORTE - SERVIETTES // TOALLEROS
45 CM / 60 CM



TOWEL RING HOLDER
ANNEAU PORTE - SERVIETTES
TOALLEROS DE ANILLA



TOILET PAPER HOLDER
PORTE - PAPIER
PORTARROLLO



HOOK // PATÈRE // PERCHA



KIT 1*
WITH SOAP DISH
AVEC PORTE-SAVON
CON JABONERA



KIT 2**
WITH GLASS HOLDER
AVEC PORTE-VERRE
CON PORTAVASO

KIT 1 TOWEL HOLDERS + TOILET PAPER HOLDER + HOOK + TOWEL RING HOLDER + SOAP DISH*
PORTE-SERVIETTES + PORTE- PAPIER + ANNEAU PORTE-SERVIETTES + PATÈRE + PORTE-SAVON*
TOALLEROS + PORTARROLLO + TOALLERO DE ANILLA + PERCHA + JABONERA*

KIT 2 TOWEL HOLDERS + TOILET PAPER HOLDER + HOOK + TOWEL RING HOLDER + GLASS HOLDER*
PORTE-SERVIETTES + PORTE- PAPIER + ANNEAU PORTE-SERVIETTES + PATÈRE + PORTE-VERRE*
TOALLEROS + PORTARROLLO + TOALLERO DE ANILLA + PERCHA + PORTAVASO*

CHROME // CHROME CROMADO  PROVIDED IN BOX // FOURNIT EN BOÎTE SUMINISTRA EN CAJA

LEAN KIT



TOWEL HOLDERS // PORTE - SERVIETTES // TOALLEROS
45 CM / 60 CM



TOWEL RING HOLDER
ANNEAU PORTE - SERVIETTES
TOALLEROS DE ANILLA



TOILET PAPER HOLDER
PORTE - PAPIER
PORTARROLLO



HOOK // PATÈRE // PERCHA



KIT 1*
WITH SOAP DISH
AVEC PORTE-SAVON
CON JABONERA



KIT 2**
WITH GLASS HOLDER
AVEC PORTE-VERRE
CON PORTAVASO

KIT 1 TOWEL HOLDERS + TOILET PAPER HOLDER + HOOK + TOWEL RING HOLDER + SOAP DISH*
PORTE-SERVIETTES + PORTE- PAPIER + ANNEAU PORTE-SERVIETTES + PATÈRE + PORTE-SAVON*
TOALLEROS + PORTARROLLO + TOALLERO DE ANILLA + PERCHA + JABONERA*

KIT 2 TOWEL HOLDERS + TOILET PAPER HOLDER + HOOK + TOWEL RING HOLDER + GLASS HOLDER*
PORTE-SERVIETTES + PORTE- PAPIER + ANNEAU PORTE-SERVIETTES + PATÈRE + PORTE-VERRE*
TOALLEROS + PORTARROLLO + TOALLERO DE ANILLA + PERCHA + PORTAVASO*

CHROME // CHROME CROMADO  PROVIDED IN BOX // FOURNIT EN BOÎTE SUMINISTRA EN CAJA

HOTEL SERIES



GRAB BAR // BARRE DE REDRESSEMENT // ASA RECTA

40 CM BRASS
60 CM LAITON
LATÓN

CHROME // CHROMÉ
CROMADO



GRAB BAR // BARRE DE REDRESSEMENT // ASA RECTA

30 CM
40 CM
50 CM

CHROME // CHROMÉ
CROMADO



**ANGULAR GRAB BAR
BARRE DE REDRESSEMENT ANGULAIRE // ASA ANGULAR**

WITH SOAP HOLDER
AVEC PORTE - SAVON
CON JABONERA

CHROME // CHROMÉ
CROMADO



**ANGULAR GRAB BAR
BARRE DE REDRESSEMENT ANGULAIRE // ASA ANGULAR**

CHROME // CHROMÉ
CROMADO



TOWEL HOLDER // PORTE - SERVIETTES // TOALLERO

DOUBLE
DOUBLE
DOBLE

CHROME // CHROMÉ
CROMADO



TOWEL HOLDER // PORTE - SERVIETTES // TOALLERO

SIMPLE
SIMPLE
SIMPLE

CHROME // CHROMÉ
CROMADO



**CORNER SPONGE BATH HOLDER
PORTE-EPONGE DE COIN // CONTENEDOR DE RINCÓN**

SMALL
PETIT
PEQUEÑO

CHROME // CHROMÉ
CROMADO



**CORNER SPONGE BATH HOLDER
PORTE-EPONGE DE COIN // CONTENEDOR DE RINCÓN**

BIG
GRAND
GRAN

CHROME // CHROMÉ
CROMADO

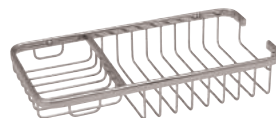

**SPONGE BATH HOLDER
PORTE-EPONGE // CONTENEDOR**

WITH SOAP HOLDER
AVEC PORTE-SAVÓN
CON JABONERA

CHROME // CHROMÉ
CROMADO



**SPONGE BATH HOLDER
PORTE-EPONGE // CONTENEDOR**

SIMPLE
SIMPLE
SIMPLE

CHROME // CHROMÉ
CROMADO



**SPONGE BATH HOLDER
PORTE-EPONGE // CONTENEDOR**

HANGING - DOUBLE
PENDAISON - DOUBLE
COLGANTE - DOBLE

CHROME // CHROMÉ
CROMADO



**TELESCOPIC MIRROR
MIRROIR TÉLÉSCOPIQUE // ESPEJO TELESCOPIO**

W/ MAGNIFYING
A/ LOUPE
C/ AUMENTO

CHROME // CHROMÉ
CROMADO



CLEAN & SAFE

SERIES

GRAB BARS - Ø35MM*
BARRES DE REDRESSEMENT - Ø35MM*
ASAS RECTAS - Ø35MM*



GRAB BAR Ø35MM

BARRE DE REDRESSEMENT Ø35MM // ASA Ø35MM

- 30 CM
- 40 CM
- 50 CM
- 60 CM
- 80 CM



90°

GRAB BAR Ø35MM

BARRE DE REDRESSEMENT Ø35MM // ASA Ø35MM

- 35 X 35 CM



135°

GRAB BAR Ø35MM

BARRE DE REDRESSEMENT Ø35MM // ASA Ø35MM

- 35 X 35 CM



FOLDING GRAB BAR Ø35MM

BARRE D'APPUI RABBATTABLE Ø35MM
 ASA FOLDABLE Ø35MM

- 60 CM
- 80 CM



FOLDING GRAB BAR W/ PAPER HOLDER Ø35MM

BARRE D'APPUI RABBATTABLE A/ PORTE-PAPIER Ø35MM
 ASA FOLDABLE CON PORTARROLLOS Ø35MM

- 60 CM
- 80 CM

AISI 304



GRAB BAR W/ 3 ANCHORING POINTS

BARRE D'APPUI A/ 3 FIXATIONS
 ASA CON 3 FONDEADEROS

- 60 CM
- 60 CM
- 80 CM
- 80 CM

AISI 304



GRAB BAR WALL TO FLOOR MOUNT

BARRE D'APPUI MUR - SOL // ASA - PARED - PISO

- 85 x 80 CM
- 85 x 80 CM

AISI 304

TILT MIRROR
MIROIR ENCADRÉ INCLINABLE
ESPEJO BASCULANTE



TILT MIRROR

MIROIR ENCADRÉ INCLINABLE // ESPEJO BASCULANTE

- 50 x 70 CM
- 60 x 80 CM

AISI 304

SOAP DISPENSERS
DISTRIBUTEURS SAVON
DISPENSADORES DE JABÓN



DSA

SOAP DISPENSER W/ SENSOR
 DISTRIBUTEUR SAVON A/ SENSEUR
 DISPENSADOR DE JABÓN C/ SENSOR

ABS

- WHITE // BLANC
- DC 4 X 1.5v AA
- 1.2 L



DSC

ELBOW DISPENSER
 DISTRIBUTEUR À COUDE // DISPENSADOR DEL CODO

ABS + STAINLESS STEEL
 ABS + ACIER INOXYDABLE
 ABS + ACERO INOXIDABLE

- WHITE // BLANC
- 1 L

* TESTED AND APPROVED FOR PRODUCTS IN COMPLIANCE CERTIFICATE LABORATORY WITH DL 163/2006
 TESTÉ ET APPROUVÉ POUR PRODUITS EN CONFORMITÉ CERTIFICAT DE LABORATOIRE AVEC DL 163/2006
 PRÓBADO Y APROBADO PARA PRODUCTOS EN LABORATORIO CERTIFICADO DE CUMPLIMIENTO CON DL 163/2006

HAND DRYER
SÈCHE-MAINS
SECADORA DE MANOS



HD2300

HAND DRYER // SÈCHE-MAINS // SECADORA DE MANOS

STAINLESS STEEL
ACIER INOXYDABLE
ACERO INOXIDABLE

BRUSHED // BROSSE
CEPILLADO ⚡ 2300 W



HD2100

HAND DRYER // SÈCHE-MAINS // SECADORA DE MANOS

ABS

WHITE // BLANC
BLANCO ⚡ 2100 W

HAIR DRYER
SÈCHEUR DE CHEVEUX
SECADOR DE PELO



SC1200

HAIR DRYER
SÈCHEUR DE CHEVEUX // SECADOR DE PELO

ABS

WHITE // BLANC
BLANCO ⚡ 1200 W



SCT1200

HAIR DRYER W/ PLUG OUTLET
SÈCHEUR DE CHEVEUX A/ PRISE
SECADOR DE PELO C/ ENCHUFE ELÉCTRICO

ABS

WHITE // BLANC
BLANCO ⚡ 1200 W

PAPER DISPENSER - SHEETS
DISTRIBUTEUR DE PAPIER - FEUILLES
DISTRIBUIDOR DE PAPEL - HOJAS



DT400

PAPER DISPENSER
DISTRIBUTEUR DE PAPIER // DISTRIBUIDOR DE PAPEL

STAINLESS STEEL
ACIER INOXYDABLE
ACERO INOXIDABLE

BRUSHED // BROSSE
CEPILLADO AISI 304 400
SHEETS // FEUILLES // HOJAS



DTN600

PAPER DISPENSER
DISTRIBUTEUR DE PAPIER // DISTRIBUIDOR DE PAPEL

ABS

WHITE // BLANC
BLANCO 600
SHEETS // FEUILLES // HOJAS



DTN600

PAPER DISPENSER
DISTRIBUTEUR DE PAPIER // DISTRIBUIDOR DE PAPEL

ABS

SILVER // ARGENT
PLATA 600
SHEETS // FEUILLES // HOJAS



DTN300

PAPER DISPENSER
DISTRIBUTEUR DE PAPIER // DISTRIBUIDOR DE PAPEL

ABS

WHITE // BLANC
BLANCO 300
SHEETS // FEUILLES // HOJAS

PAPER DISPENSER
DISTRIBUTEUR DE PAPIER
DISTRIBUIDOR DE PAPEL



DJI JUMBO

PAPER DISPENSER
DISTRIBUTEUR DE PAPIER // DISTRIBUIDOR DE PAPEL

STAINLESS STEEL
ACIER INOXYDABLE
ACERO INOXIDABLE

BRUSHED // BROSSE
CEPILLADO AISI 304 Ø220 MM



DJN JUMBO

PAPER DISPENSER
DISTRIBUTEUR DE PAPIER // DISTRIBUIDOR DE PAPEL

ABS

WHITE // BLANC
BLANCO Ø220 MM



DJN JUMBO

PAPER DISPENSER
DISTRIBUTEUR DE PAPIER // DISTRIBUIDOR DE PAPEL

ABS

SILVER // ARGENT
PLATA Ø220 MM



DMJ MINI JUMBO

PAPER DISPENSER
DISTRIBUTEUR DE PAPIER // DISTRIBUIDOR DE PAPEL

ABS

WHITE // BLANC
BLANCO Ø190 MM

SOAP DISPENSER
DISTRIBUTEUR DE SAVON
DISPENSADOR DE JABÓN



DSV 12

SOAP DISPENSER
DISTRIBUTEUR DE SAVON // DISPENSADOR DE JABÓN

STAINLESS STEEL
ACIER INOXYDABLE
ACERO INOXIDABLE

AISI 304 BRUSHED // BROSSE
CEPILLADO 1.2 L



DSH 12

SOAP DISPENSER
DISTRIBUTEUR DE SAVON // DISPENSADOR DE JABÓN

STAINLESS STEEL
ACIER INOXYDABLE
ACERO INOXIDABLE

AISI 304 BRUSHED // BROSSE
CEPILLADO 1.2 L



DSL1

SOAP DISPENSER
DISTRIBUTEUR DE SAVON // DISPENSADOR DE JABÓN

ABS

WHITE // BLANC
BLANCO 1 L



DS1

SOAP DISPENSER
DISTRIBUTEUR DE SAVON // DISPENSADOR DE JABÓN

ABS

WHITE // BLANC
BLANCO 1 L



DS05

SOAP DISPENSER
DISTRIBUTEUR DE SAVON // DISPENSADOR DE JABÓN

ABS

WHITE // BLANC
BLANCO 0.5 L



DSE

RECESSED DISPENSER
DISTRIBUTEUR À ENCASTRER // DISPENSADOR DE JABÓN

ABS

BRUSHED // BROSSE
CEPILLADO 1 L

AISI 304

The products in stainless steel AISI 304, are characterized by being little bit magnetic but very resistant to corrosion even when exposed to humid environment such as the bathroom spaces.

Les produits en acier inoxydable AISI 304, sont caractérisés par être peu magnétiques, mais très résistants à la corrosion, même lorsqu'il est exposé à un environnement humide, comme les espaces de salle de bains..

Los productos en acero inoxidable AISI 304, se caracterizan por ser ligeramente magnéticos, pero muy resistentes a la corrosión, incluso cuando se exponen a ambientes húmedos como los espacios de baño.

DEKOR

ACCESSORIES STAINLESS STEEL
ACIER INOXYDABLE ACCESSOIRES // ACCESORIOS ACERO INOXIDABLE



TOWEL HOLDER
PORTE-SERVIETTE // TOALLERO

30 CM
45 CM
60 CM

BRUSHED // BROSSE
CEPILLADO AISI 304



DOUBLE TOWEL HOLDER
PORTE-SERVIETTE DOUBLE // TOALLERO DOBLE

45 CM

BRUSHED // BROSSE
CEPILLADO AISI 304



TOILET PAPER HOLDER
PORTE-PAPIER // PORTARROLLOS

BRUSHED // BROSSE
CEPILLADO AISI 304



SOAP DISH
PORTE-SAVON // JABONERAS

BRUSHED // BROSSE
CEPILLADO AISI 304



HOOK // PATÈRE // PERCHA

BRUSHED // BROSSE
CEPILLADO AISI 304

TOILET PAPER HOLDERS PORTE-PAPIER PORTARROLLOS



TOILET PAPER HOLDER
PORTE-PAPIER // PORTARROLLOS

POLISHED
POLI
PULIDO
BRUSHED
BROSSE
CEPILLADO

AISI 304



DOUBLE TOILET PAPER HOLDER
PORTE-PAPIER DOUBLE // PORTARROLLOS DOBLE

STAINLESS STEEL
ACIER INOXYDABLE
ACERO INOXIDABLE

BRUSHED // BROSSE
CEPILLADO AISI 304



TOILET PAPER HOLDER
PORTE-PAPIER // PORTARROLLOS

STAINLESS STEEL
ACIER INOXYDABLE
ACERO INOXIDABLE

POLISHED // POLI
PULIDO

BABY CHANGE TABLE À LANGER CAMBIADOR DE BEBÉS



folding
rabattable
plegable

HORIZONTAL BABY CHANGE
TABLE À LANGER HORIZONTAL
CAMBIADOR DE BEBÉS HORIZONTAL

POLYETHYLENE
POLYÉTHYLÈNE
POLIETILENO

113 kg



folding
rabattable
plegable

VERTICAL BABY CHANGE
TABLE À LANGER VERTICAL
CAMBIADOR DE BEBÉS VERTICAL

POLYETHYLENE
POLYÉTHYLÈNE
POLIETILENO

113 kg

TOILET BRUSH PORTE BALAI ESCOBILLERO

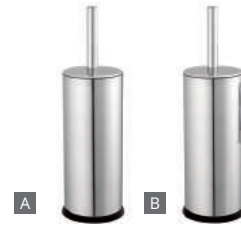

TOILET BRUSH
PORTE BALAI // ESCOBILLERO

INOX
AISI 304

FLOOR
SOL
PISO

WALL MOUNTED
MURAL
MONTADO EN LA PARED

BRUSHED // BROSSE
CEPILLADO AISI 304

TOILET BIN CORBEILLE À PAPIERS PAPELERA DE BAÑO



INOX
AISI 304

TOILET BIN
CORBEILLE À PAPIERS // PAPELERA DE BAÑO

3 L STAINLESS STEEL
5 L ACIER INOXYDABLE
12 L ACERO INOXIDABLE

BRUSHED // BROSSE
CEPILLADO AISI 304



TOILET BIN - WALL MOUNTED
CORBEILLE À PAPIERS - MURAL
PAPELERA DE BAÑO - PARED

25 L STAINLESS STEEL
ACIER INOXYDABLE
ACERO INOXIDABLE

AISI 304

PICTOGRAM SIGNS PICTOGRAMME PICTOGRAMA



PICTOGRAM SIGNS // PICTOGRAMME // PICTOGRAMA

STICKER ADHÉSIVE PEGATINAS	SCREW VIS TORNILLOS
8 X 8 CM	15 X 15 CM

MAN
HOMME
HOMBRE

WOMAN
FEMME
MUJER

UNISEX
UNISEXE
UNISEX

HANDICAPPED
HANDICAPÉ
DISCAPACITADOS

BABY CHANGE
TABLE À LANGER
CAMBIADOR
DE BEBÉS

STAINLESS STEEL
ACIER INOXYDABLE
ACERO INOXIDABLE

SERIES // SÉRIE // SERIE
LOOK

Specially designed for people with reduced mobility, is characterised by its contribution in terms of ergonomics stability, reliability, and comfort, in the daily use of bathing areas that are intended to be inclusive.

Spécialement conçu pour les personnes à mobilité réduite, se caractérise par sa contribution en termes d'ergonomie, de stabilité, de fiabilité et de confort dans l'utilisation quotidienne de zones de baignade qui sont destinés à être inclus.

Gama especialmente diseñada para personas con movilidad reducida, se caracteriza por su contribución en términos de ergonomía, estabilidad, fiabilidad y comodidad en el uso cotidiano de los espacios de baño que se piensan para ser inclusivos.

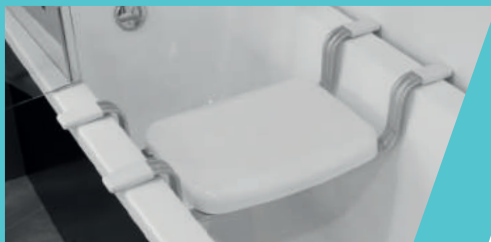

adjustable height
réglable en hauteur
regulable en altura
42 - 52 cm



BATH CHAIR // SIÈGE DE BAIGNOIRE // SILLA DE BAÑO

ABS + ALUMINIUM
ABS + ALUMINIUM
ABS + ALUMINIUM

150 kg

for bathtubs with width within
pour baignoires avec une largeur central
para bañeras con un ancho dentro

60 - 67 cm



BATH SEAT
SIÈGE DE BAIGNOIRE // ASIENTO DE BAÑERA

ABS + ALUMINIUM
ABS + ALUMINIUM
ABS + ALUMINIUM

150 kg

folding
rabattable
plegable



FOLDING SHOWER SEAT
SIÈGE DE DOUCHE RABATTABLE
ASIENTO DE DUCHA PLEGABLE

ABS + ALUMINIUM
ABS + ALUMINIUM
ABS + ALUMINIUM

120 kg

BATH SEATS
SIÈGES DE BAIN
ASSIENTOS DE BAÑO



FOLDING SHOWER SEAT
SIÈGE DE DOUCHE RABATTABLE // ASIENTO DE BAÑERA PLEGABLE

PHENOLIC / STAINLESS STEEL
ACIER INOXYDABLE / PHENOLIC
ACERO INOXIDABLE / FENÓLICO

120 kg | AISI 304



FOLDING SHOWER SEAT
SIÈGE DE DOUCHE RABATTABLE // ASIENTO DE BAÑERA PLEGABLE

STAINLESS STEEL
ACIER INOXYDABLE
ACERO INOXIDABLE

120 kg | AISI 304



TECHNICAL CLINIC SERIES



CLINIC

SINGLE LEVER MIXER // MITIGEUR // MEZCLADOR
BASIN // HAUT // LAVABO

CHROME // CHROMÉ
CROMADO



CLINIC

SINGLE LEVER MIXER // MITIGEUR // MEZCLADOR
SHOWER // DOUCHE // DUCHA

CHROME // CHROMÉ
CROMADO



SINGLE LEVER MIXER // MITIGEUR // MEZCLADOR
WALL MOUNTED SINK // ÉVIER MURAL
MURAL FREGADERO

LOW SPOUT
BEC INFÉRIEURE
CAÑO INFERIOR

CHROME // CHROMÉ
CROMADO



MONOCOMANDO
BALCÃO

LOW SPOUT
BEC BAS
CAÑO BAJO

CHROME // CHROMÉ
CROMADO



MONOCOMANDO
BALCÃO

PULL-OUT SHOWER
DOUCHETTE RÉTRACTABLE
DUCHA EXTRAÍBLE

CHROME // CHROMÉ
CROMADO

CTESI GREEN is the contribution of Ctesi® for a more sustainable planet.

Ctesi® have a deep concern with water. This is a vital resource for the entire planet. Effortless and with all comfort, choose economizer cartridges or self closing taps, for a rational use of water in any tap at home or at public places.



SELF CLOSING TAPS... A SMART CHOICE!

Water is a precious resource and we all have a duty to use it in a responsible way. The TEMP series is a set of temporized taps which rationalize water use, usually in lavatories and shower systems. Equipped with filters and cartridges, made of special materials with advanced technology, they reduce water consumption without changing the pressure. This is good news for you and for the planet.

The proper functioning of the taps is ensure only with impurity free water.

Self closing taps regulate the flow and reduce the waste of water enabling for a more efficient consumption.

It is advised the use of filters.

- Energy savings
- Hot and cold water savings
- Taps tested for 300 000 continuous cycles
- Taps equipped with filters and cartridges
- Manufactured in special materials with advanced technology
- Reduce water consumption without changing the pressure

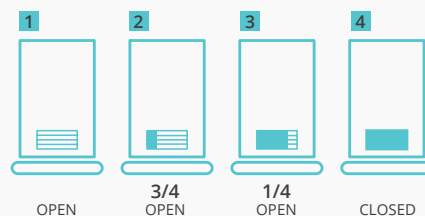

	1	2	3	4
BAR	L / M	L / M	L / M	L / M
0,5	12	10,6	7,8	2,3
1	16,8	14,4	10,2	2,8
1,5	21,5	19,8	13,2	3,4
2	24	22,3	16,8	3,9
3	33	29,4	21,6	-

CTESI GREEN est la contribution de Ctesi® pour une planète plus durable.

Ctesi® a une préoccupation profonde avec l'eau car ce ressource est essentiel pour la vie dans la planète. Sans effort et avec tout le confort, choisiss des robinets avec des cartouches économiseurs ou robinets temporisées, pour une utilisation rationalisée de l'eau dans n'importe quelle modèle de votre maison ou espace public.



ROBINETS TEMPORISÉES UN CHOIX INTELLIGENT!

L'eau est une ressource précieuse et nous avons tous le devoir de l'utiliser de façon responsable. La série TEMP est un ensemble de robinets temporisés qui rationne l'utilisation de l'eau, généralement dans les lavabos et dans les systèmes de douche. Équipés avec filtres et des cartouches économiseurs, fabriqués avec des matériaux spéciaux avec une technologie de pointe, ils réduisent la consommation d'eau sans changer la pression de l'eau. Ce sont des bonnes nouvelles pour vous et pour la planète.

Le bon fonctionnement des robinets est assuré uniquement avec de l'eau sans impuretés.

Robinet temporisées avec réglage du flux de l'eau pour plus d'économie d'eau et de l'énergie.

Il est conseillé d'utiliser des filtres.

- Économie d'énergie
- Économie d'eau chaude et froide
- Robinet testé 300 000 cycles continus
- Robinets équipées de filtres et cartouches
- Fabriqués en matériaux spéciaux avec une technologie avancée
- Réduisent la consommation d'eau sans modifier la pression.

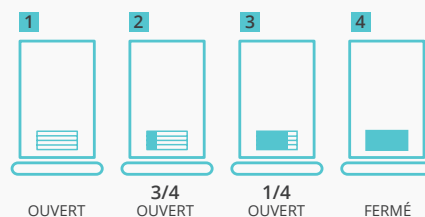

	1	2	3	4
BAR	L / M	L / M	L / M	L / M
0,5	12	10,6	7,8	2,3
1	16,8	14,4	10,2	2,8
1,5	21,5	19,8	13,2	3,4
2	24	22,3	16,8	3,9
3	33	29,4	21,6	-

Ctesi® GREEN es la contribución de Ctesi® por un planeta más sostenible.

Ctesi® tiene una profunda preocupación por el agua, y eso es vital para todo el planeta. Sin esfuerzo y con todas las comodidades, opte por los grifos con cartuchos economizadores o grifos temporizados para una racionalización del uso del agua en su casa o en espacios públicos.



GRIFERÍA TEMPORIZADA... UNA OPCIÓN INTELIGENTE!

Grifos con un cartucho que permite la elección del flujo de agua.

La serie TEMP es una serie de grifos temporizados que racionalizan el uso del agua, por lo general en lavabos y sistemas de ducha.

Equipados con filtro en el cartucho, hecho de materiales especiales y la tecnología avanzada, reducen el consumo de agua sin cambiar la presión.

Se recomienda el uso de filtros para eliminar las impurezas y para el buen funcionamiento de los grifos.

- Ahorro de energía
- Ahorro de agua fría y caliente
- Grifos ensayados con 300 000 ciclos continuos
- Grifería dotada de filtros y cartuchos
- Hecho de materiales especiales
- Con tecnología avanzada
- Reducen el consumo de agua sin cambiar la presión



	1	2	3	4
BAR	L / M	L / M	L / M	L / M
0,5	12	10,6	7,8	2,3
1	16,8	14,4	10,2	2,8
1,5	21,5	19,8	13,2	3,4
2	24	22,3	16,8	3,9
3	33	29,4	21,6	-



LINE
BASIN // LAVABO // LAVABO

CHROME // CHROMÉ
CROMADO



LUX
BASIN // LAVABO // LAVABO

CHROME // CHROMÉ
CROMADO



PLUS
BASIN // LAVABO // LAVABO

CHROME // CHROMÉ
CROMADO



MIXER // MÉLANGEUR // MEZCLADOR
BASIN // LAVABO // LAVABO

CHROME // CHROMÉ
CROMADO



TAP // ROBINET // GRIFO
BASIN // LAVABO // LAVABO

BICA ALTA
CHROME // CHROMÉ
CROMADO



TAP // ROBINET // GRIFO
WALL MOUNTED // MURAL // MURAL
1/2"

CHROME // CHROMÉ
CROMADO



WALL MOUNTED // MURAL // MURAL
SINGLE WATER INLET
UNE VOIE
1 AGUA

CHROME // CHROMÉ
CROMADO



CONCEALED // À ENCASTRER // ENCASTRAR
SINGLE WATER INLET
UNE VOIE
1 AGUA

CHROME // CHROMÉ
CROMADO



SHORT URINOL // URINOIR COURT // URINOL CORTO

SIMPLE
SIMPLE
SIMPLE

WITH CONNECTION
AVEC LIAISON
CON CONEXIÓN

CHROME // CHROMÉ
CROMADO



LONG URINOL
URINOIR LONGUE // URINOL LARGO

SIMPLE
SIMPLE
SIMPLE

WITH CONNECTION
AVEC LIAISON
CON CONEXIÓN

CHROME // CHROMÉ
CROMADO



EXTERNAL FLUSH VALVE
DÉBITMÈTRE EXTÉRIEUR
FLUJÓMETRO EXTERIOR
45°

CHROME // CHROMÉ
CROMADO



INTERNAL FLUSH VALVE
DÉBITMÈTRE INTÉRIEUR
FLUJÓMETRO INTERIOR

CHROME // CHROMÉ
CROMADO



FLUSH VALVE TUBE
TUBE FLUXMÈTRE
TUBO DE DESCARGA

ADJUSTABLE
RÉGLABLE
AJUSTABLE

CHROME // CHROMÉ
CROMADO

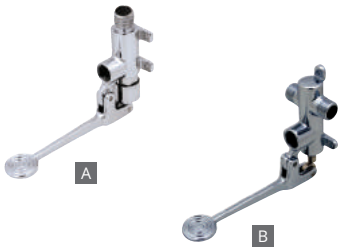

FOOT OPERATED
COMMAND AU PIED // GRIFO PEDAL

A SINGLE WATER INLET
 LINE VOIE
 1 AGUA

B SINGLE LEVER MIXER
 MITIGEUR
 MEZCLADOR

CHROME // CHROMÉ
 CROMADO



FOOT OPERATED
COMMAND AU PIED // GRIFO PEDAL

A SINGLE WATER INLET
 LINE VOIE
 1 AGUA

B SINGLE LEVER MIXER
 MITIGEUR
 MEZCLADOR

CHROME // CHROMÉ
 CROMADO



DOUBLE FOOT OPERATED
COMMAND AU PIED // GRIFO PEDAL

2 WATERS
 2 EAUX
 2 AGUAS

CHROME // CHROMÉ
 CROMADO



SPOUT // BEC // GRIFO

TUBE
 TUBE
 TUBO

CHROME // CHROMÉ
 CROMADO



SPOUT // BEC // GRIFO

CAST
 FONDU
 FUNDIDO

CHROME // CHROMÉ
 CROMADO



FOUNTAIN TAP
ROBINET FONTAINE
GRIFO PARA FUENTE

JET
 JET
 CHORRO

CHROME // CHROMÉ
 CROMADO



FOUNTAIN TAP
ROBINET FONTAINE
GRIFO PARA FUENTE

SPRING
 RESSORT
 MUELLE

CHROME // CHROMÉ
 CROMADO



COMPLEMENTS // COMPLÉMENTS // COMPLEMENTOS



CLICK CLACK
BASIN WASTE VALVE // VIDAGE LAVABO // DESAGÜE

PRIME

CHROME // CHROMÉ
 CROMADO



CLICK CLACK
BIG // GRAND // GRANDE
BASIN WASTE VALVE // VIDAGE LAVABO // DESAGÜE

PRIME

CHROME // CHROMÉ
 CROMADO



CLICK CLACK
SQUARE // CARRÉ // CUADRADO
BASIN WASTE VALVE // VIDAGE LAVABO // DESAGÜE

PRIME

CHROME // CHROMÉ
 CROMADO



**TAPS
ELECTRONIC**

Taps with electronic sensor for efficient use of water in accordance with the rules of public hygiene.

ACQUABLOCK, is a system that allows to block the sensor in situations of taps abuse. Normally, we find these taps in public spaces as a way to save water and facilitate the use by children and people with disabilities.

Power supply can be 220 / 12V AC or batteries depending on the model.



**ROBINETS
ÉLECTRONIQUE**

Robinets avec détecteur électronique pour une utilisation efficace de l'eau, conformément aux règles d'hygiène public.

ACQUABLOCK, c'est un système qui permet de bloquer situations d'abus des robinets. Normalement, on trouve ces robinets dans les espaces publics, comme un moyen d'économiser l'eau et faciliter l'utilisation par des enfants et des personnes handicapées.

Selon le modèle le dispositif d'alimentation peut être 220 / 12V AC ou de piles.



**GRIFERÍA
ELECTRÓNICA**

Grifos equipados con Sensor electrónico para el uso eficiente del agua de acuerdo con las normas de higiene pública.

AQUABLOCK, es un sistema que bloquea el sensor en situaciones de abuso del uso de los grifos. Por lo general encontramos estos grifos en los espacios públicos como una forma de ahorrar agua y por su facilidad de uso, especialmente en materia de higiene que aseguran a las personas con movilidad reducida.

Dependiendo del modelo de temporizador, se puede conectar a un dispositivo de potencia 220 / 12V A.C. o pilas.



KEEN

**ELECTRONIC TAP // ROBINET ÉLECTRONIQUE // GRIFO ELÉCTRICO
BASIN // LAVABO // LAVABO**

SINGLE WATER INLET
UNE VOIE
1 AGUA
2 WATERS
2 EAUX
2 AGUAS



INSIDE

**TAP // ROBINET // GRIFO
BASIN // LAVABO // LAVABO**

SINGLE WATER INLET
UNE VOIE
1 AGUA
2 WATERS
2 EAUX
2 AGUAS



bellian FINISHES

The Bellian® space is designed for contemporary living, offering a world of possibilities for your bathroom environment. Our inspiration is the very spirit of life, a universe full of detail and beauty. A delight for the most sensitive eye, able to distinguish this authenticity in Bellian® world. After choosing the furniture that suits your space, choose the finish that best expresses your personality. Since the glossy lacquered finish or lacquered Italian oak, woods or Bellian® textures, there are many options that we offer you. Choose the one that best fits your style. The quality of the materials used in Bellian® bathroom furniture gives it excellent resistance to everyday use. We build to your needs, with the form and the finish that best expresses your personality.

bellian FINITIONS

L'espace Bellian® est conçu pour la vie contemporaine, offrant un monde de possibilités pour votre environnement de salle de bains. Notre inspiration est l'esprit même de la vie, un univers plein de détails et de la beauté. Un régal pour les yeux les plus sensibles, capables de distinguer cette authenticité dans le monde Bellian®. Après avoir choisi le meuble dans la forme qui convient à votre espace, choisissez la finition qui exprime mieux votre personnalité. De la finition laqué brillant ou la finition en chêne italien laqué jusqu'à les bois et les textures Bellian®, il existe des nombreuses options que nous mettons à votre disposition. Choisissez celle qui correspond le mieux à votre style. La qualité des matériaux utilisés dans les meubles de salle de bains Bellian® donne une excellente résistance à une utilisation quotidienne. Nous construisons à vos besoins, avec la forme et la finition qui exprime le mieux votre personnalité.

bellian ACABADOS

El espacio Bellian® se ha diseñado para la vida contemporánea ofreciendo un mundo de posibilidades para su entorno de baño. Nuestra inspiración nace del propio espíritu de vida, un universo lleno de detalles y belleza. Una delicia para los ojos más sensibles, capaces de distinguir esta autenticidad del mundo Bellian®. Después de la elección de su mueble, también puede elegir el acabado que prefiera. Desde lacados de alto brillo o roble italiano con acabado mate, a las maderas nobles y texturas Bellian®, hay numerosas opciones que ponemos a su disposición. La calidad de los materiales utilizados en muebles de baño Bellian®, le dan una excelente resistencia al uso diario.



BELLIAN COLOURS // COULEURS BELLIAN // COLORES BELLIAN



WHITE BLANC BLANCO BLACK NOIR NEGRO ANTHRACITE ANTHRACITE ANTRACITE BORDEAUX BORDEAUX BORDEAUX EGGPLANT AUBERGINE BERENJENA RED ROUGE ROJO BEIGE BEIGE BEIGE PINE GREEN VERT PINO VERDE PINO SAPPHIRE SAPHIR ZAFIRO



OAK WOOD // BOIS DE CHÊNE // ROBLE ITALIANO

AVAILABLE FOR FREE BASE UNIT // DISPONIBLE POUR MEUBLE FREE // DISPONIBLE SOLO EN EL MODELO FREE



WHITE BLANC BLANCO BLACK NOIR NEGRO ANTHRACITE ANTHRACITE ANTRACITE BORDEAUX BORDEAUX BORDEAUX EGGPLANT AUBERGINE BERENJENA RED ROUGE ROJO BEIGE BEIGE BEIGE PINE GREEN VERT PINO VERDE PINO SAPPHIRE SAPHIR ZAFIRO



WOOD TEXTURES // BOIS TEXTURES // TEXTURAS MADERAS



ESTEPA WOOD BOIS ESTEPA FRESNO ESTEPA TAIGA WOOD BOIS TAIGA FRESNO TAIGA CHERRY WOOD BOIS CERISE MADERA CEREJO GRAFITE WENGE WENGE GRAFITE WENGER GRAFITO WENGE WENGE WENGER



WOODS // BOIS // MADERAS



WALNUT NOYER NOGAL CORK LIÈGE CORCHO WENGE WENGE WENGER



SPECIAL FINISHES FINITIONS SPÉCIALES // ACABADOS ESPECIALES

FOR DONNA LUX BASE UNIT // POUR MEUBLE DONNA LUX // EN EL MODELO DONNA LUX



GOLD OR ORO SILVER ARGENT PLATA LEATHER CUIR CUERO



TEXTURES TEXTURES // TEXTURAS

FOR TWICE BASE UNIT // POUR MEUBLE TWICE // EN EL MODELO TWICE

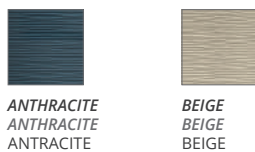

ANTHRACITE ANTHRACITE ANTRACITE BEIGE BEIGE BEIGE



Bellian® environmental, economic and social best practices have been recognized and which are part of the principles and criteria of the FSC® referential. The FSC® certification testifies that Bellian® bathroom furniture is certified and produced using wood from responsibly managed forests, providing direct benefits for these forests, such as the protection of the biodiversity, Human Rights, the protection of endangered species and proactive forestry policies with a significant environmental and cultural importance. Via an independent audit by the Soil Association Certification Limited, Barros & Moreira, S.A. obtained the FSC® (Forest Stewardship Council) Certification with the reference n° SA-COC-004972, valid for the Production of Bathroom Furniture.

Bellian® a été reconnue pour ses pratiques environnementales, économiques et sociales qui font partie des principes et des critères du référentiel FSC®. La certification FSC® garantit que le meuble de salle de bain Bellian® certifié est produit à partir de bois provenant de forêts bien gérées, avec des bénéfices directs pour les forêts, tels que la protection de la biodiversité, les droits humains, la protection des espèces menacées et politiques forestières participatives d'une importance environnementale et culturelle significative. Par moyen d'une audit indépendante menée par la Soil Association Certification Limited, Barros et Moreira, S.A. a obtenu la certification FSC® (Forest Stewardship Council) sous le code n° SA-COC-004972 pour la fabrication de meubles de salle de bains.

Bellian® es una marca reconocida por la FSC®, por sus prácticas ambientales, económicas y sociales. La certificación FSC® testificó que los muebles de baño Bellian® son producidos utilizando madera de bosques gestionados de forma responsable, proporcionando beneficios directos para estos bosques, tales como la protección de la biodiversidad, los derechos humanos, la protección de especies en peligro de extinción y las políticas forestales proactivas con una importancia ambiental y cultural significativa. A través de una auditoría independiente por la Soil Association Certification Limited, Barros y Moreira, S.A. obtuvo la Certificación FSC® (Consejo de Administración Forestal) con la referencia n° SA-COC-004972, válido para la producción de muebles de baño.

bellian®

BATHROOM FURNITURE
MEUBLES DE SALLE DE BAINS
MUEBLES DE BAÑO



Wide range of options to furnish your bathroom space to suit you with the highest level of prestige, by the quality of materials, finishes as for its design.

Large gamme d'options pour meubler votre espace de salle de bains à vos besoins avec le plus haut niveau de prestige, la qualité des matériaux, et les finitions au même temps que sa Conception.

Amplia gama de opciones para amueblar su espacio de baño a sus necesidades con el más alto nivel de prestigio, la calidad de los materiales y por el diseño de sus acabados.

bellian

KUBIS

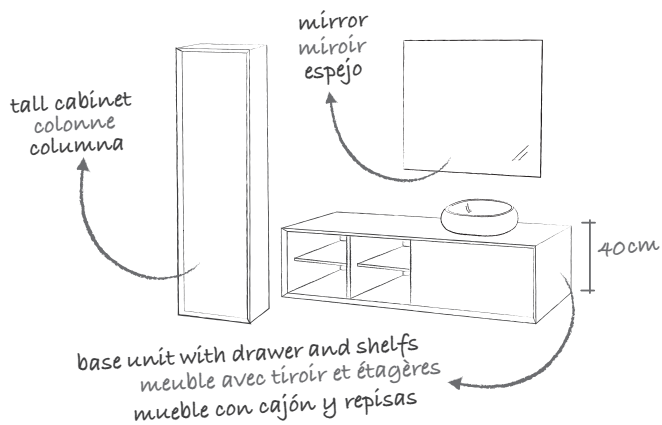

MODULAR COMPOSITIONS

The furniture KUBIS is a modular construction that allows you to choose your bathroom furniture to measure your taste and space. In the end, you have a unique model built specifically for you. For all the choices, each KUBIS composition is always supplied in one piece, ready to install and with a common countertop to the various elements that compose it.

COMPOSITIONS MODULAIRES

Les meubles KUBIS font partie d'une construction modulaire qui vous permet de choisir le meuble à la mesure de votre goût et de votre espace. A la fin, vous avez un modèle unique construit spécialement pour vous. Pour toutes les choix que vous optiez, chaque composition KUBIS est toujours fournie en une seule pièce, prêt à installer et avec un top commun aux différents éléments qui le composent.

COMPOSICIONES MODULARES

KUBIS parte de una construcción modular que le permite elegir el MUEBLE para adaptarse a su gusto y su espacio. Recibe un único modelo construido específicamente para usted. Independientemente de su elección cualquier composición KUBIS siempre se proporciona en una sola pieza, listo para instalar y con una cubierta común de los distintos elementos que lo componen.

WOODS // BOIS // MADERAS



WALNUT
NOYER
NOGAL



CORK
LIÈGE
CORCHO



WENGE
WENGÉ
WENGER

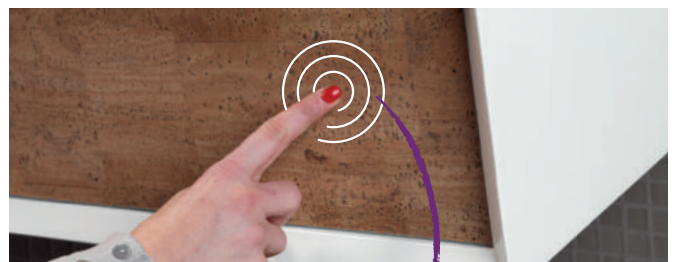

"click" opening system
système d'ouverture "clic"
sistema de apertura "clic"

60 CM BASE UNIT WITH 1 DRAWER - WHITE AND CORK | 80CM BASE UNIT WITH 1 DRAWER - WHITE AND CORK COTTON
COUNTERTOP CERAMIC WASHBASIN | SMOOTH TALL SINGLE LEVER BASIN MIXER | LESS 100 CM MIRROR
ALTAIR LIGHT FIXTURE
MEUBLE 60 CM AVEC 1 TIROIR - BLANC ET LIÈGE | MEUBLE 80 CM AVEC 1 TIROIR - BLANC ET LIÈGE
COTTON VASQUE À POSER EN CÉRAMIQUE | SMOOTH LAVABO HAUT MITIGEUR | LESS MIROIR 100 CM | APPLIQUE ALTAIR
MUEBLE 60 CM CON 1 CAJÓN - BLANCO Y CORCHO | MUEBLE 80 CM CON 1 CAJÓN - BLANCO Y CORCHO
COTTON LAVABO DE PORCELANA DE POSAR | SMOOTH LAVABO MONOMANDO | LESS ESPEJO 100 CM
APLIQUE ALTAIR



160 CM BASE UNIT WITH 2 SHELFs AND 1 DRAWER - WHITE AND WENGE | FROST COUNTERTOP CERAMIC WASHBASIN | NEXT BUILT-IN SINGLE LEVER BASIN MIXER
 CABINET WITH 1 DOOR - WHITE AND WENGE | LEDS 80 CM MIRROR
 MEUBLE 160 CM AVEC 2 ÉTAGÈRES ET 1 TIROIR - BLANC ET WENGÉ | FROST VASQUE À POSER EN CÉRAMIQUE | NEXT LAVABO À ENCASTRER MITIGEUR
 COLONNE AVEC 1 PORTE - BLANC ET WENGÉ | LEDS MIROIR 80 CM
 MUEBLE 160 CM CON 2 REPISAS Y 1 CAJÓN - BLANCO Y WENGER | FROST LAVABO DE PORCELANA DE POSAR | NEXT MONOMANDO LAVABO
 COLUMNA CON 1 PUERTA - BLANCO Y WENGER | LEDS ESPEJO 80 CM

BELLIAN COLOURS
 COULEURS BELLIAN
 COLORES BELLIAN

		
WHITE BLANC BLANCO	BLACK NOIR NEGRO	ANTHRACITE ANTHRACITE ANTRACITE
		
BORDEAUX BORDEAUX BORDEAUX	EGGPLANT AUBERGINE BERENJENA	RED ROUGE ROJO
		
BEIGE BEIGE BEIGE	PINE GREEN VERT PIN VERDE PINO	SAPPHIRE SAPHIR ZAFIRO

Solutions multiplicity
Plusieurs solutions
 Multiplicidade soluciones

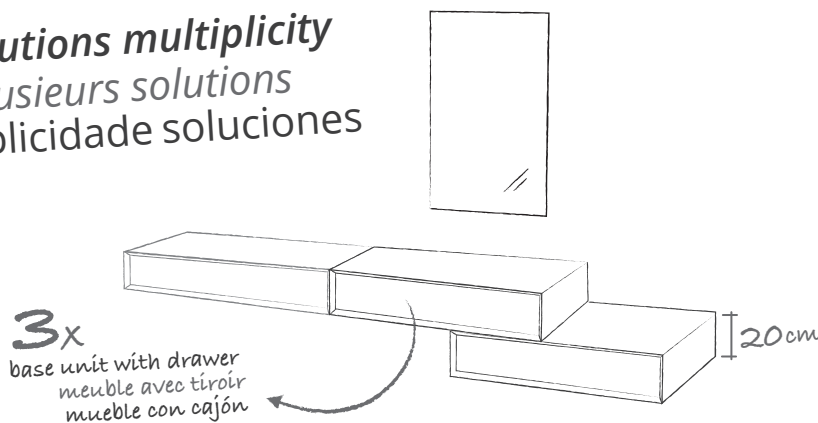

BASE UNIT WITH 1 SHELF AND 1 DRAWER (RIGHT OR LEFT)
MEUBLE AVEC 1 ÉTAGÈRE ET 1 TIROIR (DROIT O GAUCHE)
MUEBLE CON 1 ESTANTE Y 1 CAJÓN (DERECHA O IZQUIERDA)

100 - 120 - 140	BELLIAN COLOURS COULEURS BELLIAN COLORES BELLIAN	BELLIAN C. + WOODS C. BELLIAN + BOIS C. BELLIAN + MADERAS	RAL COLOURS COULEURS RAL COLORES RAL	RAL C. + WOODS C. RAL + BOIS C. RAL + MADERAS
100 - 120 - 140				

BASE UNIT WITH 2 SHELVES AND 1 DRAWER (RIGHT OR LEFT)
MEUBLE AVEC 2 ÉTAGÈRES ET 1 TIROIR (DROIT O GAUCHE)
MUEBLE CON 2 REPISAS Y 1 CAJÓN (DERECHA O IZQUIERDA)

140 - 160 - 180	BELLIAN COLOURS COULEURS BELLIAN COLORES BELLIAN	BELLIAN C. + WOODS C. BELLIAN + BOIS C. BELLIAN + MADERAS	RAL COLOURS COULEURS RAL COLORES RAL	RAL C. + WOODS C. RAL + BOIS C. RAL + MADERAS
140 - 160 - 180				

BASE UNIT WITH 2 SHELVES AND 1 DRAWER (CENTER)
MEUBLE AVEC 2 ÉTAGÈRES ET 1 TIROIR (CENTRE)
MUEBLE CON 2 REPISAS Y 1 CAJÓN (CENTRO)

140 - 160 - 180	BELLIAN COLOURS COULEURS BELLIAN COLORES BELLIAN	BELLIAN C. + WOODS C. BELLIAN + BOIS C. BELLIAN + MADERAS	RAL COLOURS COULEURS RAL COLORES RAL	RAL C. + WOODS C. RAL + BOIS C. RAL + MADERAS
140 - 160 - 180				

BASE UNIT H 40CM WITH 1 DRAWER
MEUBLE H 40 CM AVEC 1 TIROIR (CENTRE)
MUEBLE H 40 CM CON 1 CAJÓN (CENTRO)

60 - 80 - 100	BELLIAN COLOURS COULEURS BELLIAN COLORES BELLIAN	BELLIAN C. + WOODS C. BELLIAN + BOIS C. BELLIAN + MADERAS	RAL COLOURS COULEURS RAL COLORES RAL	RAL C. + WOODS C. RAL + BOIS C. RAL + MADERAS
60 - 80 - 100				

BASE UNIT H 20CM WITH 1 DRAWER
MEUBLE H 20 CM AVEC 1 TIROIR (CENTRE)
MUEBLE H 20 CM CON 1 CAJÓN (CENTRO)

60 - 80 - 100	BELLIAN COLOURS COULEURS BELLIAN COLORES BELLIAN	BELLIAN C. + WOODS C. BELLIAN + BOIS C. BELLIAN + MADERAS	RAL COLOURS COULEURS RAL COLORES RAL	RAL C. + WOODS C. RAL + BOIS C. RAL + MADERAS
60 - 80 - 100				

CABINET WITH 1 DOOR
COLONNE AVEC 1 PORTE
COLUMNA CON 1 PUERTA

40	BELLIAN COLOURS COULEURS BELLIAN COLORES BELLIAN	BELLIAN C. + WOODS C. BELLIAN + BOIS C. BELLIAN + MADERAS	RAL COLOURS COULEURS RAL COLORES RAL	RAL C. + WOODS C. RAL + BOIS C. RAL + MADERAS
40				

LESS // LESS LEDS
MIRROR // MIROIR // ESPEJO

60 - 80 - 100 - ML	WITHOUT LEDS SANS LEDS SIN LEDS	WITH LEDS AVEC LEDS CON LEDS
60 - 80 - 100 - ML		

DELTA
MIRROR W/ LEDS STRIP // MIROIR A/ BANDE LEDS // ESPEJO C/ TIRA DE LEDS

	70 - 90	70 x 70	90 x 90
	70 - 90		

LEDS
MIRROR WITH LEDS // MIROIR AVEC LEDS // ESPEJO CON LEDS

60 - 80 - 100	WITHOUT LEDS SANS LEDS SIN LEDS	WITH LEDS AVEC LEDS CON LEDS
60 - 80 - 100		

ALTAIR
LED LIGHT FIXTURE // APLIQUE LED // APLIQUE LED

	34.5
	34.5

LINE // LINE II
LED LIGHT FIXTURE // APLIQUE LED // APLIQUE LED

	28 ou 50	28	50
	28 ou 50		

COTTON
CERAMIC COUNTERTOP WASHBASIN
VASQUE À POSER EN CÉRAMIQUE
LAVABO DE PORCELANA DE POSAR

	15.5	Ø39
	15.5	Ø39

FROST
CERAMIC COUNTERTOP WASHBASIN
VASQUE À POSER EN CÉRAMIQUE
LAVABO DE PORCELANA DE POSAR

	40.5	14.5	49.5	49	WHITE BLANC BLANCO
	40.5	14.5	49.5	49	WHITE BLANC BLANCO

ALPES
CERAMIC SEMI RECESSED WASHBASIN
VASQUE SEMI-ENCASTRE EN CÉRAMIQUE
LAVABO DE PORCELANA SEMIENCASTRADO

	39	59	WHITE BLANC BLANCO
	39	59	WHITE BLANC BLANCO

LYNX
CERAMIC COUNTERTOP WASHBASIN
VASQUE À POSER EN CÉRAMIQUE
LAVABO DE PORCELANA DE POSAR

	45	60	11	60	WHITE BLANC BLANCO
	45	60	11	60	WHITE BLANC BLANCO

CREATE YOUR BATHROOM FURNITURE

The KUBIS modular system allows with some elements to build only one furniture. To this end, upon order, a simple set design will be necessary. Please indicate the location of the basin, as well as the codes and colors of modules. Get the form to request for a quote and/or order through one of our partners or by e-mail: geral@grupobm.pt

CRÉEZ VOS MEUBLES DE SALLE DE BAINS

Le système modulaire KUBIS permet, avec quelques éléments, construire seulement un meuble. À cette fin, sur commande, ajoutez un ensemble de conception simple. Indiquez la position du bassin, ainsi que les codes et les couleurs ou par e-mail: geral@grupobm.pt.

CREA TU MUEBLE DE BAÑO

El sistema modular KUBIS permite, con algunos elementos, construir un único mueble. A tal efecto, bajo pedido, adjuntando un diseño sencillo del conjunto será necesario. Indicar la ubicación de la cuenca, así como los códigos y colores de los módulos. Obtenga el formulario para solicitar un presupuesto y/o pedido a través de uno de nuestros socios o por medio de correo electrónico: geral@grupobm.pt



TWO 80 CM BASE UNITS WITH 1 DRAWER - ANTHRACITE | SMOOTH SINGLE LEVER BASIN MIXER DELTA 90 CM MIRROR | ALPES SEMI RECESSED CERAMIC WASHBASIN
 2 X MEUBLE 80 CM AVEC 1 TIROIR - ANTHRACITE | SMOOTH LAVABO MITIGEUR DELTA MIROIR 90 CM | ALPES VASQUE SEMI-ENCASTRÉ EN CÉRAMIQUE
 2 X MUEBLE 80 CM CON 1 CAJÓN - ANTHRACITE | SMOOTH LAVABO MONOMANDO DELTA ESPEJO 90 CM | ALPES LAVABO DE PORCELANA SEMIENCASTRADO



60 CM BASE UNIT WITH 1 DRAWER - WHITE AND WALNUT | 80 CM BASE UNIT WITH 1 DRAWER - WHITE AND WALNUT | KEEN TALL SINGLE LEVER BASIN MIXER | LESS 100 CM MIRROR | FROST CERAMIC COUNTERTOP WASHBASIN
 MEUBLE 60 CM AVEC 1 TIROIR - BLANC ET NOYER | MEUBLE 80 CM AVEC 1 TIROIR - BLANC ET NOYER
 SMOOTH LAVABO HAUT MITIGEUR | LESS MIROIR 100 CM | FROST VASQUE À POSER EN CÉRAMIQUE
 MUEBLE 60 CM CON 1 CAJÓN - BLANCO Y NOGAL | MUEBLE 80 CM CON 1 CAJÓN - BLANCO Y NOGAL SMOOTH LAVABO ALTO MONOMANDO | LESS ESPEJO 100 CM | FROST LAVABO DE PORCELANA DE POSAR

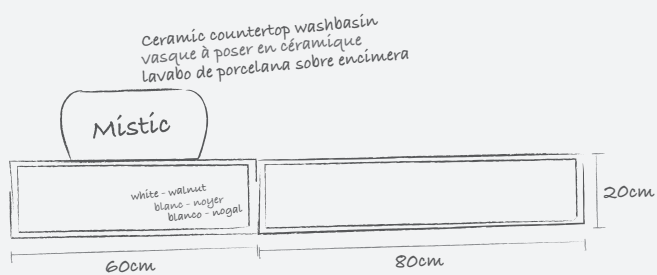

bellan
AVENUE

MODULAR COMPOSITIONS

AVENUE allows you to assemble your bathroom furniture through a modular design so you can adapt your furniture to the requirements of your bath space.

COMPOSITIONS MODULAIRES

AVENUE vous permet de composer votre meuble de bain à travers d'une conception modulaire afin que vous pouvez adapter votre meuble à les exigences de votre espace de bain.

COMPOSICIONES MODULARES

El mueble AVENUE permite la composición de su mueble de baño a través de una construcción modular para que pueda personalizar su mueble según sus requisitos del espacio de baño.

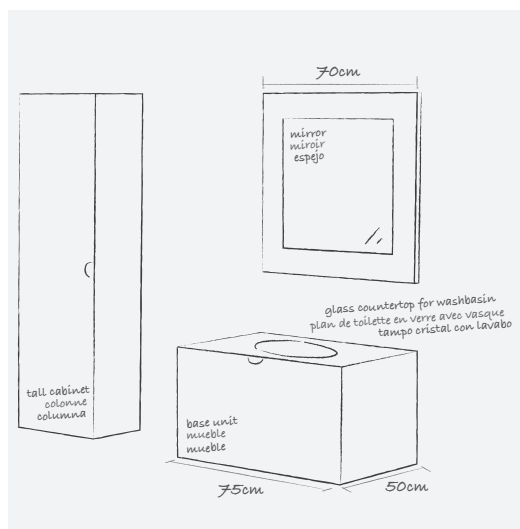

CREATE YOUR BATHROOM FURNITURE

The AVENUE modular system allows with some elements to build only one furniture. To this end, upon order, a simple set design will be necessary. Please indicate the location of the basin, taps, as well as the codes and colors of modules.

Get the form to request for a quote and/or order through one of our partners or by e-mail: geral@grupobm.pt

CRÉEZ VOS MEUBLES DE SALLE DE BAINS

Le système modulaire AVENUE permet, avec quelques éléments, construire un seul meuble. À cette fin, sur commande, ajoutez un ensemble de conception simple. Indiquez, s'il vous plait pour la position du bassin et des robinets et envoyez-nous par e-mail: geral@grupobm.pt.

CREA TU MUEBLE DE BAÑO

El sistema modular AVENUE permite, con algunos elementos, construir un único mueble. A tal efecto, bajo pedido, adjuntando un diseño sencillo del conjunto será necesario indicar la ubicación del lavabo y de los grifos, así como los códigos y colores de los módulos.

Obtenga el formulario para solicitar un presupuesto y/o pedido a través de uno de nuestros socios o por medio de correo electrónico: geral@grupobm.pt



bellian®

AVENUE



75 CM BASE UNIT WITH 1 DRAWER - BLACK | CABINET WITH 1 DOOR - BLACK | GOLD 80 CM MIRROR | 75 CM GLASS COUNTERTOP WITH WASHBASIN - GOLDEN | STRAW SINGLE LEVER BASIN MIXER - GOLDEN
MEUBLE 75 CM AVEC 1 TIROIR - NOIR | COLONNE AVEC 1 PORTE - NOIR | GOLD MIROIR 80 CM | PLAN DE TOILETTE EN VERRE AVEC VASQUE 75 CM - DORÉ | STRAW DORÉ LAVABO MITIGEUR
MUEBLE 75 CM CON 1 CAJÓN - NEGRO | COLUMNA CON 1 PUERTA - NEGRO | GOLDEN ESPEJO 80 CM | TAMPO DE CRISTAL CON LAVABO 75 CM - DORADO | STRAW DORADA LAVABO MONOMANDO

DISCOVER THE PREMIUM
RANGE OF BELLIAN® MIRRORS

DÉCOUVREZ LA GAMME
PREMIUM DES MIROIRS BELLIAN®

CONOZCA LA GAMA
PREMIUM DE ESPELHOS BELLIAN®

PAG. 149

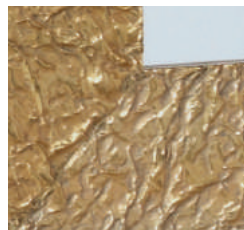

GOLDEN // DORÉ // DORADO



SILVER // ARGENT // PLATA



75 CM BASE UNIT WITH 1 DRAWER - ANTHRACITE | 50 CM AUXILIARY BASE UNIT WITH 2 DRAWERS - ANTHRACITE | 125 CM GLASS COUNTERTOP WITH WASHBASIN - WHITE | AVENUE 125 CM MIRROR WITH LEDS | STRAW SINGLE LEVER BASIN MIXER
 MEUBLE 75 CM AVEC 1 TIROIR - ANTHRACITE | MEUBLE AUXILIARE 50 CM AVEC 2 TIROIRS - ANTHRACITE | PLAN DE TOILETTE EN VERRE AVEC VASQUE 125 CM - BLANC | AVENUE MIROIR AVEC LEDS 125 CM | STRAW LAVABO MITIGEUR
 MUEBLE 75 CM CON 1 CAJÓN - ANTHRACITE | MUEBLE AUXILIAR 50 CM CON 2 CAJÓNES - ANTHRACITE | TAMPO DE CRISTAL CON LAVABO 125 CM - BLANCO | AVENUE ESPEJO CON LEDS 125 CM | STRAW LAVABO MONOMANDO

BASE UNIT WITH 1 DRAWER

MEUBLE AVEC 1 TIROIR
 MUEBLE CON 1 CAJÓN

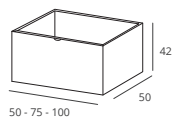

BELLIAN COLOURS COULEURS BELLIAN COLORES BELLIAN	RAL COLOURS COULEURS RAL COLORES RAL
50	
75	
100	

AUXILIARY BASE UNIT WITH 2 DRAWERS

MEUBLE AUXILIARE AVEC 2 TIROIRS
 MUEBLE AUXILIAR CON 2 CAJÓNES

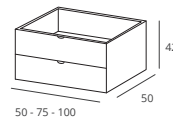

BELLIAN COLOURS COULEURS BELLIAN COLORES BELLIAN	RAL COLOURS COULEURS RAL COLORES RAL
50	
75	
100	

CABINET WITH 1 DOOR

COLONNE AVEC 1 PORTE
 COLUMNA CON 1 PUERTA

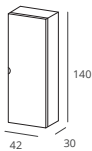

BELLIAN COLOURS COULEURS BELLIAN COLORES BELLIAN	RAL COLOURS COULEURS RAL COLORES RAL
40	

AVENUE

MIRROR WITH LEDS // MIROIR AVEC LEDS // ESPEJO CON LEDS

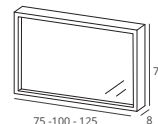

BELLIAN COLOURS COULEURS BELLIAN COLORES BELLIAN	RAL COLOURS COULEURS RAL COLORES RAL
75	
100	
125	

COUNTERTOP - LACQUERED OR GLASS

PLAN DE TOILETTE - LAQUÉ O VERRE
 TAMPO - LACADO O CRISTAL

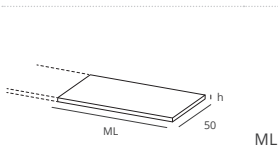

LACQUERED COUNTERTOP PLAN DE TOILETTE LAQUÉ TAMPO LACADO h = 2,5 mm		GLASS COUNTERTOP PLAN DE TOILETTE EN VERRE TAMPO DE CRISTAL h = 1,5 mm	
BELLIAN COLOURS COULEURS BELLIAN COLORES BELLIAN	RAL COLOURS COULEURS RAL COLORES RAL	BELLIAN COLOURS COULEURS BELLIAN COLORES BELLIAN	RAL COLOURS COULEURS RAL COLORES RAL

GLASS COUNTERTOP WITH WASHBASIN

PLAN DE TOILETTE EN VERRE AVEC VASQUE- LAQUÉ O VERRE
 TAMPO DE CRISTAL CON LAVABO

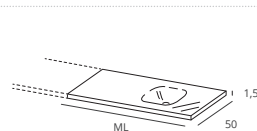

BELLIAN COLOURS COULEURS BELLIAN COLORES BELLIAN	RAL COLOURS COULEURS RAL COLORES RAL
ML	



LEDS

MIRROR // MIROIR // ESPEJO

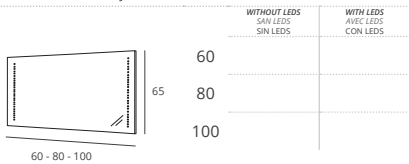

50 CM BASE UNIT WITH 1 DRAWER - BEGE | 50 CM AUXILIARY BASE UNIT WITH 2 DRAWERS - BEGE | 100 CM LACQUERED COUNTERTOP - BEGE | LEDS 100 CM MIRROR
COTTON CERAMIC COUNTERTOP WASHBASIN | STRAW TALL SINGLE LEVER BASIN MIXER
MEUBLE 50 CM AVEC 1 TIROIR - BEGE | MEUBLE AUXILIAIRE 50 CM AVEC 2 TIROIRS - BEGE | PLAN DE TOILETTE EN LAQUÉ 100 CM - BEGE | LEDS MIROIR 100 CM
COTTON VASQUE À POSER EN CÉRAMIQUE | STRAW LAVABO HAUT MITTIGEUR
MUEBLE 50 CM CON 1 CAJÓN - BEGE | MUEBLE AUXILIAR 50 CM CON 2 CAJÓNES - BEGE | TAMPO LACADO 100 CM - BEGE | LEDS ESPEJO 100 CM COTTON
LAVABO DE PORCELANA DE POSAR | STRAW LAVABO MONOMANDO

GOLD // SILVER

MIRROR WITH FRAME // MIROIR AVEC CADRE // ESPEJO CON MARCO

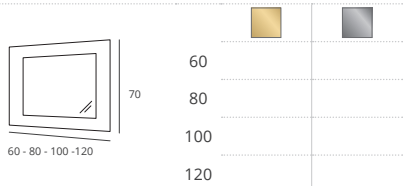

ALTAIR

LED LIGHT FIXTURE // APLIQUE LED // APLIQUE LED

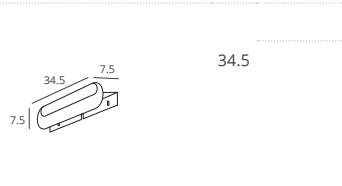

LINE // LINE II

LED LIGHT FIXTURE // APLIQUE LED // APLIQUE LED

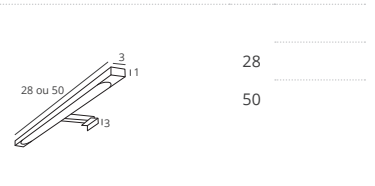

COTTON

CERAMIC COUNTERTOP WASHBASIN
VASQUE À POSER EN CÉRAMIQUE
LAVABO DE PORCELANA DE POSAR



FROST

CERAMIC COUNTERTOP WASHBASIN
VASQUE À POSER EN CÉRAMIQUE
LAVABO DE PORCELANA DE POSAR



ALPES

CERAMIC COUNTERTOP WASHBASIN
VASQUE À POSER EN CÉRAMIQUE
LAVABO DE PORCELANA DE POSAR

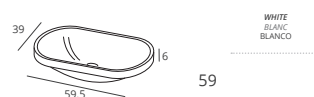

LYNX

CERAMIC COUNTERTOP WASHBASIN
VASQUE À POSER EN CÉRAMIQUE
LAVABO DE PORCELANA DE POSAR

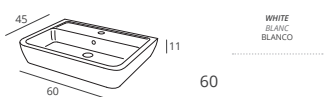



MIRRORED DOOR
Column with mirrored door and side shelves for easy access.

PORTE EN MIRROR
Colonne avec porte en miroir et étagères latérales pour un accès facile.

PUERTA CON ESPEJO
Columna con puerta de espejo y repisas laterales de fácil acceso.

80 CM BASE UNIT WITH 1 DRAWER - WHITE | 80 CM AUXILIARY BASE UNIT WITH 1 DRAWER - BLACK | 60 CM LACQUERED COUNTERTOP - BLACK | VIDRO 81 CM GLASS COUNTERTOP WASHBASIN - BLACK | SMOOTH SINGLE LEVER BASIN MIXER | LESS 120 CM MIRROR | LINE II LIGHT FIXTURE
MEUBLE 80 CM AVEC 1 TIROIR - BLANC | MEUBLE AUXILIAIRE 80 CM AVEC 1 TIROIR - NOIR | PLAN DE TOILETTE LACQUÉ 60 CM - NOIR | VIDRO PLAN VASQUE EN VERRE | SMOOTH LAVABO MITIGEUR | LESS MIROIR 120 CM | LINE II APPLIQUE
MUEBLE 80 CM CON 1 CAJÓN - BLANCO | MUEBLE AUXILIAR 80 CM CON 1 CAJÓN - NEGRO | TAMPO LACADO 60 CM - NEGRO | VIDRO LAVABO DE CRISTAL DE ENCIMERA | STRAW LAVABO MONOMANDO | LESS ESPEJO 120 CM | LINE II APLIQUE

COMPOSITIONS MODULAIRES

Obtenez la composition imaginé pour votre espace de salle de bains avec les composants disponibles dans les solutions METRIC.

Faites une composition en fonction de vos besoins et construisez un meuble unique en termes de formes et de finitions.

Pour assurer l'exactitude de la solution des meubles idéalisé, nous vous suggérons de joindre un dessin de la composition souhaitée.

MODULAR COMPOSITIONS

Get the composition idealized for your bathroom space with the supply of components available in METRIC solutions.

Make a composition to suit your needs and build a single cabinet in terms of shapes and finishes.

To ensure the accuracy of the furniture solution that you idealized, we suggest that you attach a drawing of the desired composition.

COMPOSICIONES MODULARES

Recibe la composición prevista para su espacio de baño con el suministro de las soluciones METRIC.

Hayga una composición de acuerdo con sus necesidades y construye un solo mueble cuanto a formas y acabados.

Para asegurar la exactitud de los muebles de la solución idealizada, sugerimos que se adjunte un dibujo de la composición deseada.



60 CM BASE UNIT WITH 1 DRAWER - WALNUT | 80 CM AUXILIARY BASE UNIT WITH 1 DRAWER - WALNUT | 60 CM AUXILIARY BASE UNIT WITH 1 DRAWER - WHITE | 140 CM GLASS COUNTERTOP - WHITE
 40 CM LACQUERED COUNTERTOP - WHITE | FROST CERAMIC COUNTERTOP WASHBASIN | PIXEL TALL SINGLE LEVER BASIN MIXER | LESS 140 CM MIRROR WITH LEDS | CABINET WITH 1 MIRRORRED DOOR AND
 SHELVES - WALNUT
 MEUBLE 60 CM AVEC 1 TIROIR - NOYER | MEUBLE AUXILIARE 80 CM AVEC 1 TIROIR - NOYER | MEUBLE AUXILIARE 60 CM AVEC 1 TIROIR - WHITE | PLAN DE TOILETTE EN VERRE 140 CM - BLANC | PLAN DE TOILETTE
 LACQUÉ 40 CM - BLANC FROST VASQUE EN CÉRAMIQUE À POSER | PIXEL LAVABO HAUT MITIGEUR | LESS MIROIR AVEC LEDS 140 CM | COLONNE AVEC 1 PORTE AVEC MIROIR ET ÉTAGERES - NOYER
 MUEBLE 60 CM CON 1 CAJÓN - NOGAL | MUEBLE AUXILIAR 80 CM CON 1 CAJÓN - NOGAL | MUEBLE AUXILIAR 60 CM CON 1 CAJÓN - BLANC | TAMPO DE CRISTAL 140 CM - BLANCO | TAMPO LACADO
 60 CM - BLANCO
 FROST LAVABO DE PORCELANA DE POSAR | PIXEL LAVABO ALTO MONOMANDO | LESS ESPEJO CON LEDS 140 CM | COLUMNA CON 1 PUERTA CON ESPEJO Y REPISAS - NOGAL

BELLIAN COLOURS // COULEURS BELLIAN // COLORES BELLIAN
 RAL COLOURS // COULEURS RAL // COLORES RAL



WOODS // BOIS // MADERAS



WALNUT
NOYER
NOGAL

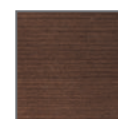

WENGE
WENGÉ
WENGER



bellian
METRIC

BASE UNIT WITH 1 DRAWER
MEUBLE AVEC 1 TIROIR
MUEBLE CON 1 CAJÓN

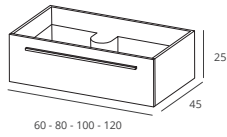

	WITH WASHBASIN // AVEC VASQUE // CON LAVABO		WITH WASHBASIN // AVEC VASQUE // CON LAVABO		WITH WASHBASIN // AVEC VASQUE // CON LAVABO	
	GLASS // VERRE // CRISTAL	CERAMIC CERAMIQUE PORCELANA	GLASS // VERRE // CRISTAL	CERAMIC CERAMIQUE PORCELANA	GLASS // VERRE // CRISTAL	CERAMIC CERAMIQUE PORCELANA
60						
80						
100						
120**						

** 2 BOWLS // 2 CUVES // 2 PIAIS

AUXILIARY BASE UNIT WITH 1 DRAWER
MEUBLE AUXILIARE AVEC 1 TIROIR
MUEBLE AUXILIAR CON 1 CAJÓN

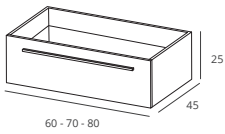

60			
70			
80			

CABINET WITH 1 DOOR AND SHELVES
COLONNE AVEC 1 PORTE ET ÉTAGÈRES
COLUMNA CON 1 PUERTA Y REPISAS

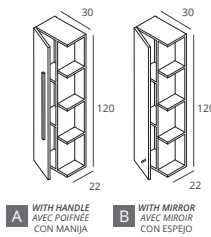

A 30						
B 30						

COUNTERTOP
PLAN DE TOILETTE
TAMPO

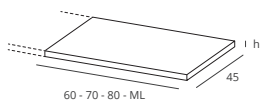

	LACQUERED // LAQUÉ // LACADO h = 2,6 mm			GLASS // VERRE // CRISTAL h = 1,5 mm		
60						
70				-	-	-
80				-	-	-
ML				-	-	-

LINE // LINE II
LED LIGHT FIXTURE // APLIQUE LED // APLIQUE LED

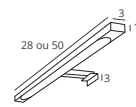

28	
50	

LESS // LESS LEDS
MIRROR // MIROIR // ESPEJO

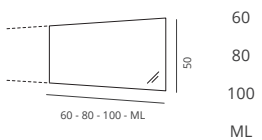

	WITHOUT LEDS SIN LEDS	WITH LEDS AVEC LEDS CON LEDS
60		
80		
100		
ML		

LEDS
MIRROR // MIROIR // ESPEJO

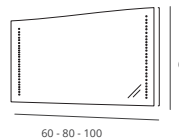

	WITHOUT LEDS SIN LEDS	WITH LEDS AVEC LEDS CON LEDS
60		
80		
100		

LYRA // LYRA II
LED LIGHT FIXTURE // APLIQUE LED // APLIQUE LED

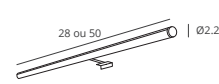

28	
50	

COTTON

CERAMIC COUNTERTOP WASHBASIN
VASQUE À POSER EN CÉRAMIQUE
LAVABO DE PORCELANA DE POSAR



WHITE
BLANC
BLANCO

FROST

CERAMIC COUNTERTOP WASHBASIN
VASQUE À POSER EN CÉRAMIQUE
LAVABO DE PORCELANA DE POSAR



WHITE
BLANC
BLANCO

NEPAL

CERAMIC COUNTERTOP WASHBASIN
VASQUE À POSER EN CÉRAMIQUE
LAVABO DE PORCELANA DE POSAR



WHITE
BLANC
BLANCO

LYNX

CERAMIC COUNTERTOP WASHBASIN
VASQUE À POSER EN CÉRAMIQUE
LAVABO DE PORCELANA DE POSAR

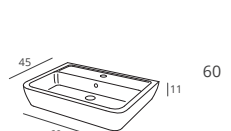

WHITE
BLANC
BLANCO

CREATE YOUR BATHROOM FURNITURE

The METRIC modular system allows with some elements to build only one furniture. To this end, upon order, a simple set design will be necessary. Please indicate the location of the basin and taps. Get the form to request for a quote and/or order through one of our partners or by e-mail: geral@grupobm.pt

CRÉEZ VOS MEUBLES DE SALLE DE BAINS

Le système modulaire METRIC permet, avec quelques éléments, construire un seul meuble. À cette fin, sur la commande, ajoutez un ensemble de conception simple. Indiquez, s'il vous plaît la position du bassin et des robinets et envoyez-nous par e-mail: geral@grupobm.pt.

CREA TU MUEBLE DE BAÑO

El sistema modular METRIC permite, con algunos elementos, construir un único mueble. A tal efecto, bajo pedido, adjunte un diseño sencillo del conjunto donde será necesario indicar la ubicación del lavabo y de los grifos. Obtenga el formulario para solicitar un presupuesto y/o pedido a través de uno de nuestros socios o por medio del correo electrónico: geral@grupobm.pt



80 CM BASE UNIT WITH 1 DRAWER - BLACK | MODERN 81 CM CERAMIC COUNTERTOP WASHBASIN
 SMOOTH SINGLE LEVER BASIN MIXER | LEDS 80 CM MIRROR
 MEUBLE 80 CM AVEC 1 TIROIR - NOIR | MODERN PLAN VASQUE EN CÉRAMIQUE 81 CM
 SMOOTH LAVABO MITIGEUR | LEDS MIROIR 80 CM
 MUEBLE 80 CM CON 1 CAJÓN - NEGRO | MODERN LAVABO DE ENCIMERA DE PORCELANA 81 CM
 SMOOTH LAVABO MONOMANDO | LEDS ESPEJO 80 CM

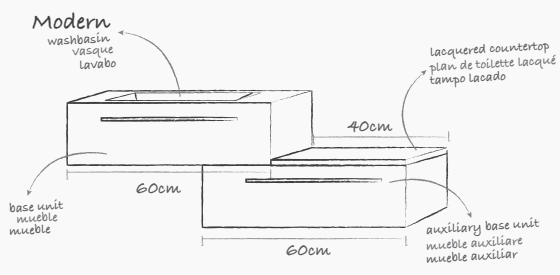

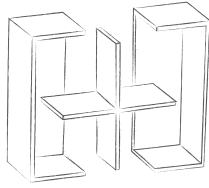

MODULAR SUPPORT

Compose your bathing support joining two open shelves of 60 cm and a shelf in white acrylic. A elegant answer to the needs of your bath space.

SUPPORT MODULAIRES

Composez votre support de bain joignant deux étagères ouvertes de 60 cm et une séparation en acrylique blanc FREE pour répondre avec élégance aux besoins de votre espace de bain.

MODULAR DIVISIÓN

Componga su apoyo de baño agregando 2 repisas abiertas de 60 cm y una división en acrílico blanco para responder en libertad con mayor elegancia a las necesidades de su espacio.



60 CM COUNTERTOP - ANTHRACITE | FREEZE CERAMIC COUNTERTOP WASHBASIN | KEEN SINGLE LEVER BASIN MIXER | 60 CM CABINET WITH DOOR - ANTHRACITE | 120 CM CABINET WITH DOOR - ANTHRACITE | LESS 60 CM MIRROR | TRAFFIC LIGHT FIXTURE
TWO 60 CM SHELVES - RAL (YELLOW) | SHELF DIVIDER - WHITE ACRYLIC
PLAN DE TOILETTE LAQUÉ 60 CM - ANTHRACITE | FREEZE VASQUE É POSER EN CÉRAMIQUE | KEEN LAVABO MITIGEUR | COLONNE AVEC 1 PORTE 60 CM - ANTHRACITE | COLONNE AVEC 1 PORTE 120 CM - ANTHRACITE | LESS MIROIR 690 CM
TRAFFIC APPLIQUE | 2 ÉTAGÈRES 60 CM - RAL (JAUNE) | ÉTAGÈRE INTÉRIEURE - ACRYLIQUE BLANC
ENCIMERA 60 CM - ANTHRACITE | FREEZE LAVABO DE PORCELANA DE POSAR | KEEN LAVABO MONOMANDO | COLUMNA CON 1 PUERTA 60 CM - ANTHRACITE | COLUMNA CON 1 PUERTA 120 CM - ANTHRACITE | LESS ESPEJO 60 CM
TRAFFIC APLIQUE | 2 REPISAS 60 CM - RAL (AMARILLO) | PARTIÇÃO - ACRÍLICO BLANCO

LACQUERED WOOD

FREE offers natural texture of excellence, in Italian oak, lacquered with the color of your choice.

BOIS NATURAL

Le meuble FREE se présente avec une texture naturelle d'excellence en chêne italien qui est laqué avec la couleurs de votre choix.

LACADO SOBRE TEXTURA NATURAL

El mueble FREE se presenta con una textura en roble italiano, de excelencia natural que es lacado con el color de su elección.



MODULAR COMPOSITIONS

Have all the freedom to create and furnish your bathroom with FREE solutions. A complete solution for bathroom furniture, versatile and adaptable to the requirements of the most dynamic bathroom areas.

COMPOSITIONS MODULAIRES

Vous avez toute la liberté de créer et meubler votre salle de bain avec les solutions FREE. Une solution complète de meubles de salle de bains, polyvalent et adaptable aux exigences des espaces plus dynamiques de salle de bains.

COMPOSICIONES MODULARES

Tenga toda la libertad de crear y decorar su cuarto de baño con las soluciones FREE. Una solución de mobiliario de baño, versátil y adaptable a las exigencias de los espacios de baño más dinámicos.

BELLIAN COLOURS // COULEURS BELLIAN // COLORES BELLIAN

WHITE BLANC BLANCO	BLACK NOIR NEGRO	ANTHRACITE ANTHRACITE ANTRACITE	BORDEAUX BORDEAUX BORDEAUX	EGGPLANT AUBERGINE BERENJENA
RED ROUGE ROJO	BEIGE BEIGE BEIGE	PINE GREEN VERT PIN VERDE PINO	SAPPHIRE SAPHIR ZAFIRO	

bellan

FREE



80 CM COUNTERTOP - ANTHRACITE | FRESH CERAMIC COUNTERTOP WASHBASIN | SMOOTH SINGLE LEVER BASIN MIXER | TWO 60 CM SHELVES - ANTHRACITE | TWO 120 CM CABINETS WITH 1 DOOR - ANTHRACITE | DELTA 90 CM MIRROR
PLAN DE TOILETTE LAQUÉ 80 CM - ANTHRACITE | FRESH VASQUE À POSER EN CÉRAMIQUE | SMOOTH LAVABO MITIGEUR | 2 ÉTAGÈRES 60 CM - ANTHRACITE | 2 COLONNES AVEC 1 PORTE 120 CM - ANTHRACITE | DELTA MIROIR 90 CM
ENCIMERA 80 CM - ANTHRACITE | FRESH LAVABO DE PORCELANA DE POSAR | SMOOTH LAVABO MONOMANDO | 2 REPISAS 60 CM - ANTHRACITE | 2 COLUMNAS CON 1 PUERTA 120 CM - ANTHRACITE | DELTA ESPEJO 90 CM

**MORE FREEDOM TO CREATE
AND FURNISH YOUR BATHROOM SPACE**

**PLUS LIBERTÉ POUR CRÉER
ET MEUBLER VOTRE ESPACE SALLE DE BAIN**

**MÁS LIBERTAD PARA CREAR
Y DECORAR SU ESPACIO DE BAÑO**

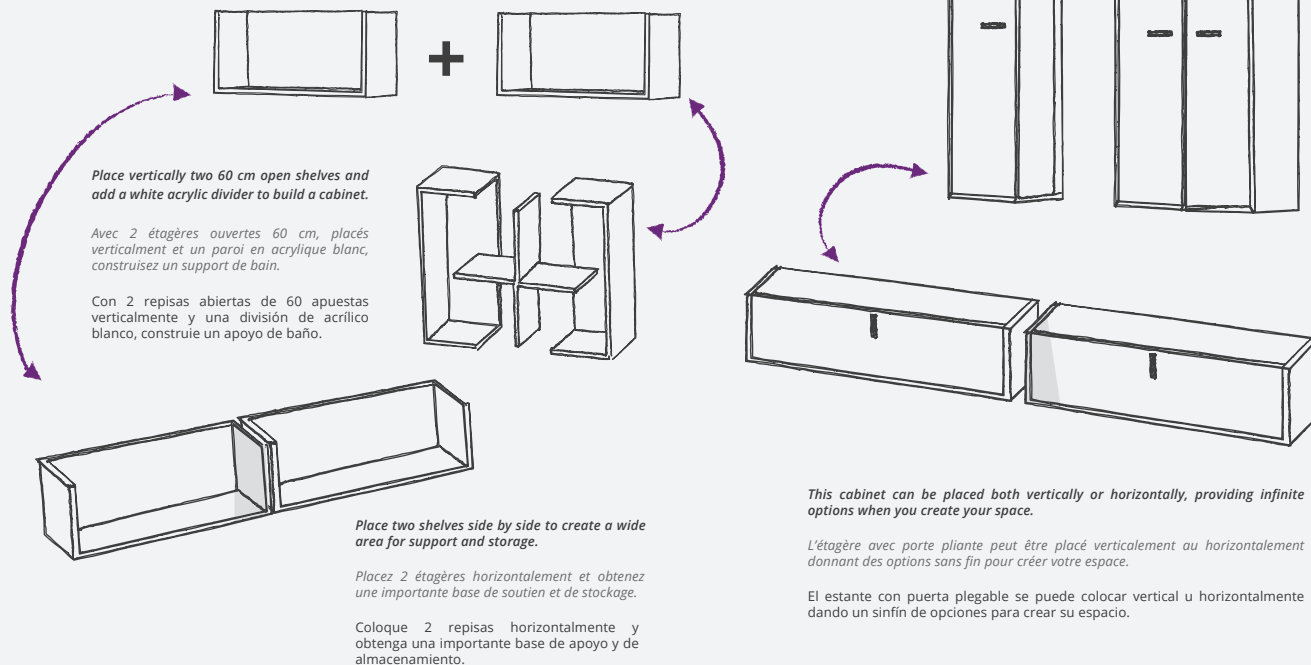

Place vertically two 60 cm open shelves and add a white acrylic divider to build a cabinet.

Avec 2 étagères ouvertes 60 cm, placés verticalement et un paroi en acrylique blanc, construisez un support de bain.

Con 2 repisas abiertas de 60 apuestas verticalmente y una división de acrílico blanco, construíe un apoyo de baño.

Place two shelves side by side to create a wide area for support and storage.

Placez 2 étagères horizontalement et obtenez une importante base de soutien et de stockage.

Coloque 2 repisas horizontalmente y obtenga una importante base de apoyo y de almacenamiento.

This cabinet can be placed both vertically or horizontally, providing infinite options when you create your space.

L'étagère avec porte pliante peut être placée verticalement au horizontalement donnant des options sans fin pour créer votre espace.

El estante con puerta plegable se puede colocar vertical u horizontalmente dando un sinfin de opciones para crear su espacio.

LACQUERED COUNTERTOP WITH OR WITHOUT WASHBASIN
PLAN DE TOILETTE LAQUÉ AVEC OU SANS VASQUE
TAMPO LACADO CON O SIN LAVABO

15 45 60 - 70 - 80 - 90 - 100 - 120	BELLIAN COLOURS COULEURS BELLIAN COLORES BELLIAN		RAL COLOURS COULEURS RAL COLORES RAL	
	WITHOUT WASHBASIN SIN VASQUES SIN LAVABO	WITH FRESH WASHBASIN AVEC VASQUE FRESH CON LAVABO FRESH	WITHOUT WASHBASIN SIN VASQUES SIN LAVABO	WITH FRESH WASHBASIN AVEC VASQUE FRESH CON LAVABO FRESH
60				
70				
80				
90				
100				
120				

CABINET WITH 1 DOOR
COLONNE AVEC 1 PORTE
COLUMNNA CON 1 PUERTA

60 90 120	BELLIAN COLOURS COULEURS BELLIAN COLORES BELLIAN		RAL COLOURS COULEURS RAL COLORES RAL	
	60 - 90 - 120			

DIVIDER SHELF
ÉTAGÈRE INTÉRIEURE
REPISA Y PARTICIÓN

56 17 56	WHITE ACRYLIC ACRILIQUE BLANC ACRILICO BLANCO	
56		

SHELF
ÉTAGÈRE
ESTANTE

60 90 120	BELLIAN COLOURS COULEURS BELLIAN COLORES BELLIAN		RAL COLOURS COULEURS RAL COLORES RAL	
60 - 90 - 120				

DELTA
MIRROR WITH LEDS // MIROIR AVEC LEDS // ESPEJO CON LEDS

70 x 70
90 x 90
70 - 90

LESS // LESS LEDS
MIRROR // MIROIR // ESPEJO

60 80 100 ML	WITHOUT LEDS SIN LEDS	WITH LEDS AVEC LEDS CON LEDS
	60 - 80 - 100 - ML	

LISO

MIRROR WITH CHROMED FRAME
MIROIR AVEC CADRE CHROMÉ // ESPEJO CON MARCO CROMO

60
80
100
60 - 80 - 100



120 CM COUNTERTOP - BLACK | TWO 90 CM CABINETS WITH 1 DOOR - BLACK | 2 FRESH CERAMIC COUNTERTOP WASHBASINS | 2 SMOOTH SINGLE LEVER BASIN MIXERS | TWO 60 CM SHELVES - WHITE
 120 CM CABINET WITH 1 DOOR - WHITE | LESS 120 CM MIRROR | 2 LINE LIGHT FIXTURES
 PLAN DE TOILETTE LAQUÉ 120 CM - NOIR | 2 COLONNES AVEC 1 PORTE 90 CM - BLACK | 2 FRESH VASQUES À POSER EN CÉRAMIQUE | 2 SMOOTH LAVABO MITTIGEURS | 2 ÉTAGÈRES 60 CM - BLANC
 COLONNE AVEC 1 PORTE 120 CM - BLANC | LESS MIROIR 120 CM | 2 LINE APLIQUES
 ENCIMERA 120 CM - NEGRO | 2 COLUMNAS CON 1 PUERTA 90 CM - NEGRO | 2 FRESH LAVABOS DE PORCELANA DE POSAR | 2 SMOOTH LAVABO MONOMANDOS
 2 REPISAS 60 CM - BLANCO | COLUMNA CON 1 PUERTA 120 CM - BLANCO | LESS ESPEJO 120 CM | 2 LINE APLIQUE

CREATE YOUR BATHROOM FURNITURE

Attach a drawing of the desired set, indicating the location of basin and tap, as the colors of the modules intended. Get the form to request for a quote and/or order through one of our partners or by e-mail: geral@grupobm.pt

CREEZ VOTRE SALLE DE BAIN

Attachez un dessin de l'ensemble souhaité, indiquant l'emplacement du robinet et du lavabo, ainsi que les couleurs des modules destinés. Obtenez le formulaire pour un devis et/ou demande pour un de nos partenaires ou par e-mail: geral@grupobm.pt

CREA TU MUEBLE DE BAÑO

Acople un dibujo del conjunto deseado, indicando la posición del grifo y del lavabo, como también los colores de los módulos previstos. Obtenga el formulario para solicitar un presupuesto y/o pedido a través de uno de nuestros socios o por medio de correo electrónico geral@grupobm.pt.



LINE // LINE II

LED LIGHT FIXTURE // APLIQUE LED // APLIQUE LED

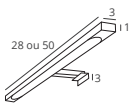

28
50

ALTAIR

LED LIGHT FIXTURE // APLIQUE LED // APLIQUE LED

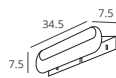

34.5

TRAFFIC

LED LIGHT FIXTURE // APLIQUE LED // APLIQUE LED



Ø9

FREEZE

CERAMIC COUNTERTOP WASHBASIN
 VASQUE À POSER EN CÉRAMIQUE
 LAVABO DE PORCELANA DE POSAR

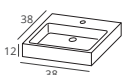

38

WHITE
 BLANC
 BLANCO

CLOUD

CERAMIC COUNTERTOP WASHBASIN
 VASQUE À POSER EN CÉRAMIQUE
 LAVABO DE PORCELANA DE POSAR

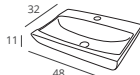

48

WHITE
 BLANC
 BLANCO

CANYON

CERAMIC COUNTERTOP WASHBASIN
 VASQUE À POSER EN CÉRAMIQUE
 LAVABO DE PORCELANA DE POSAR

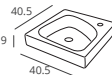

40

WHITE
 BLANC
 BLANCO

FRESH

CERAMIC COUNTERTOP WASHBASIN
 VASQUE À POSER EN CÉRAMIQUE
 LAVABO DE PORCELANA DE POSAR

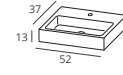

60

WHITE
 BLANC
 BLANCO



RAL® COLORS

RAL® COLORS can be chosen by consulting our RAL color book from hundreds of possibilities. You can choose up to 2 RAL colors to apply to your components.

RAL® COULEURS

LES COULEURS RAL® peuvent être choisis en consultant notre carnet des couleurs RAL parmi des centaines de possibilités. Vous pouvez choisir jusqu'à 2 couleurs RAL pour appliquer à les composants.

RAL® COLORES

Las COLORES RAL® se pueden elegir mediante la consulta de nuestro libro de colores RAL de entre cientos de posibilidades. Usted puede elegir un máximo de 2 colores RAL para aplicar a sus componentes.



DISCOVER THE PREMIUM RANGE OF BELLIAN® MIRRORS

DÉCOUVREZ LA GAMME PREMIUM DES MIROIRS BELLIAN®

CONOZCA LA GAMA PREMIUM DE ESPEJOS BELLIAN®

PAG 149

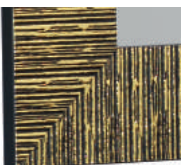

GOLD SCRATCHED

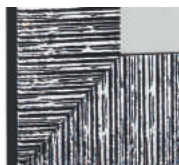

SILVER SCRATCHED



SILVER BLACK



SILVER SNOW





DIAMONDS 100 CM BASE UNIT WITH FEET 1 DRAWER + INTERIOR DRAWER - BLACK | DIAMONDS 2 DOOR CABINET WITH FEET - BLACK | SILVER BLACK 100 CM MIRROR | MODERN 101 CM CERAMIC COUNTERTOP WASHBASIN | PIXEL SINGLE LEVER BASIN MIXER
 MEUBLE DIAMONDS 100 CM AVEC 1 TIROIR + TIROIR INTÉRIEUR ET PIEDS - NOIR | COLONNE DIAMONDS AVEC 2 PORTES AND PIEDS - NOIR | SILVER BLACK MIROIR 100 CM | MODERN PLAN VASQUE EN CÉRAMIQUE 101 CM | PIXEL MITIGEUR LAVABO
 MUEBLE DIAMONDS 100 CM CON 1 CAJON + CAJON INTERIOR Y PATAS - NEGRO | COLUMNA DIAMONDS CON 2 PORTES Y PATAS - NEGRO | SILVER BLACK ESPEJO 100 CM | MODERN LAVABO DE ENCIMERA DE PORCELANA 101 CM | PIXEL MONOMANDO DE LAVABO



80 CM BASE UNIT WITH 1 DRAWER + INTERIOR DRAWER - WHITE | CABINET WITH 2 DOORS - WHITE | LEDS 80 CM MIRROR | MODERN 81 CM CERAMIC COUNTERTOP WASHBASIN | KEEN SINGLE LEVER BASIN MIXER
 MEUBLE 80 CM AVEC 1 TIROIR + TIROIR INTÉRIEUR - BLANC | COLONNE AVEC 2 PORTES - BLANC | LEDS MIROIR 80 CM | MODERN PLAN VASQUE EN CÉRAMIQUE 81 CM | KEEN MITIGEUR LAVABO
 MUEBLE 80 CM CON 1 CAJON + CAJON INTERIOR - BLANCO | COLUMNA CON 2 PORTES - BLANCO | LEDS ESPEJO 80 CM | MODERN LAVABO DE ENCIMERA DE PORCELANA 81CM | KEEN MONOMANDO DE LAVABO

BASE UNIT WITH FEET 1 DRAWER + INTERIOR DRAWER
 MEUBLE AVEC 1 TIROIR + TIROIR INTÉRIEUR ET PIEDS
 MUEBLE CON 1 CAJON + 1 CAJON INTERIOR Y PATAS

BASE UNIT 1 DRAWER + INTERIOR DRAWER
 MEUBLE AVEC 1 TIROIR + TIROIR INTÉRIEUR
 MUEBLE CON 1 CAJON + 1 CAJON INTERIOR

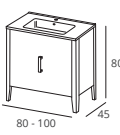
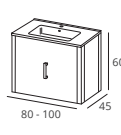
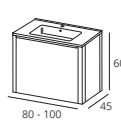
ABBIEY DIAMONDS				ABBIEY DIAMONDS					
 <p>80 - 100</p>	WITH WASHBASIN // AVEC VASQUE // CON LAVABO GLASS // VERRE // CRISTAL CERAMIC CERAMIQUE PORCELANA (MODERN)		WITH WASHBASIN // AVEC VASQUE // CON LAVABO GLASS // VERRE // CRISTAL CERAMIC CERAMIQUE PORCELANA (MODERN)		 <p>80 - 100</p>	WITH WASHBASIN // AVEC VASQUE // CON LAVABO GLASS // VERRE // CRISTAL CERAMIC CERAMIQUE PORCELANA (MODERN)		WITH WASHBASIN // AVEC VASQUE // CON LAVABO GLASS // VERRE // CRISTAL CERAMIC CERAMIQUE PORCELANA (MODERN)	
	80	100	80	100		80	100	80	100
ABBIEY				ABBIEY					
 <p>80 - 100</p>	WITH WASHBASIN // AVEC VASQUE // CON LAVABO GLASS // VERRE // CRISTAL CERAMIC CERAMIQUE PORCELANA (MODERN)		WITH WASHBASIN // AVEC VASQUE // CON LAVABO GLASS // VERRE // CRISTAL CERAMIC CERAMIQUE PORCELANA (MODERN)		 <p>80 - 100</p>	WITH WASHBASIN // AVEC VASQUE // CON LAVABO GLASS // VERRE // CRISTAL CERAMIC CERAMIQUE PORCELANA (MODERN)		WITH WASHBASIN // AVEC VASQUE // CON LAVABO GLASS // VERRE // CRISTAL CERAMIC CERAMIQUE PORCELANA (MODERN)	
	80	100	80	100		80	100	80	100

CABINET WHIT 2 DOORS
 COLONNE AVEC 2 PORTES
 COLUMNA CON 2 PUERTAS

CABINET WHIT 2 DOORS
 COLONNE AVEC 2 PORTES
 COLUMNA CON 2 PUERTAS

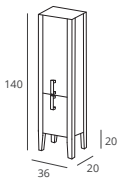
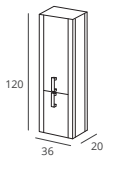
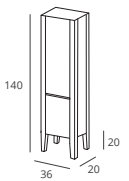
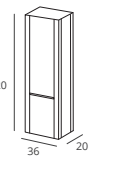
ABBIEY DIAMONDS				ABBIEY							
 <p>140</p>	 <p>120</p>	WITH FEET AVEC PIEDS CON PATAS SUSPENDED SUSPENDU SUSPENDIDO		WITH FEET AVEC PIEDS CON PATAS SUSPENDED SUSPENDU SUSPENDIDO		 <p>140</p>	 <p>120</p>	WITH FEET AVEC PIEDS CON PATAS SUSPENDED SUSPENDU SUSPENDIDO		WITH FEET AVEC PIEDS CON PATAS SUSPENDED SUSPENDU SUSPENDIDO	
		36	20	36	20			36	20	36	20



80 CM BASE UNIT WITH FEET 1 DRAWER + INTERIOR DRAWER - RAL | LISO 80 CM MIRROR | MODERN 81 CM CERAMIC COUNTERTOP WASHBASIN
 50 CM LINE II LIGHT FIXTURE | STAR SINGLE LEVER BASIN MIXER
 MEUBLE 80 CM AVEC 1 TIROIR + TIROIR INTERIEUR - RAL | LISO MIROIR 80 CM | MODERN PLAN VASQUE EN CERAMIQUE 81 CM
 LINE II APPLIQUE 50 CM | STAR MITIGEUR LAVABO
 MUEBLE 80 CM CON 1 CAJON + CAJON INTERIOR - RAL | LISO ESPEJO 80 CM | MODERN LAVABO DE ENCIMERA DE PORCELANA 81 CM
 LINE II APLIQUE 50 CM | STAR MONOMANDO DE LAVABO



LEDS

MIRROR WITH LEDS // MIROIR AVEC LEDS // ESPEJO CON LEDS

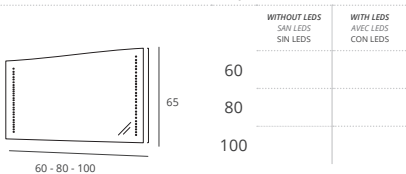

LISO

MIRROR WITH CHROMED FRAME
 MIROIR AVEC CADRE CHROME // ESPEJO CON MARCO CROMO

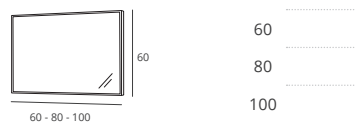

SILVER BLACK

MIRROR // MIROIR // ESPEJO

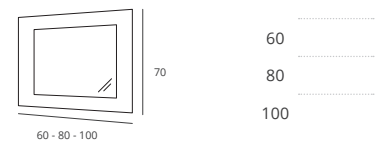

LINE // LINE II

LED LIGHT FIXTURE // APLIQUE LED // APLIQUE LED

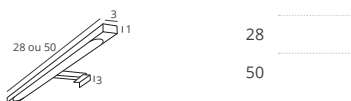

LEO

LED LIGHT FIXTURE // APLIQUE LED // APLIQUE LED



VERO

LED LIGHT FIXTURE // APLIQUE LED // APLIQUE LED

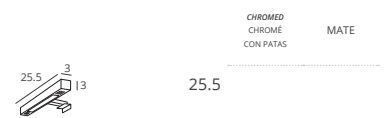



100 CM BASE UNIT WITH 1 DRAWER + INTERIOR DRAWER - WHITE | GAUDI 100 CM MIRROR - WHITE | MODERN 101 CM CERAMIC COUNTERTOP WASHBASIN 50 CM LINE II LIGHT FIXTURE | STRAW SINGLE LEVER BASIN MIXER
 MEUBLE 100 CM AVEC 1 TIROIR + TIROIR INTÉRIEUR - BLANC | GAUDI MIROIR 100 CM - BLANC | MODERN PLAN VASQUE EN CÉRAMIQUE 101 CM LINE II APPLIQUE 50 CM | STRAW MITIGEUR LAVABO
 MUEBLE 100 CM CON 1 CAJON + CAJON INTERIOR - BLANCO | GAUDI ESPEJO 100 CM - BLANCO | MODERN LAVABO DE ENCIMERA DE PORCELANA 101 CM LINE II APLIQUE 50 CM | STRAW MONOMANDO DE LAVABO



To do things right, we need first of all to love what we do and then technique.

Pour bien faire les choses, nous devons tout d'abord aimer ce que nous faisons et ensuite la technique.

Para hacer bien las cosas, primero es necesario amor, y despues la técnica.

Antoni Gaudí



Metal drawers with soft-close and glass side protection.

Tiroirs métalliques avec fermeture soft-close et verre de protection latérale.

Cajones metálicos de cierre suave con vidrio de protección lateral.



BELLIAN COLOURS // COULEURS BELLIAN // COLORES BELLIAN



WHITE
BLANC
BLANCO



BLACK
NOIR
NEGRO



ANTHRACITE
ANTHRACITE
ANTRACITE



BORDEAUX
BORDEAUX
BORDEAUX



EGGPLANT
AUBERGINE
BERENJENA



RED
ROUGE
ROJO



BEIGE
BEIGE
BEIGE



PINE GREEN
VERT PIN
VERDE PINO



SAPPHIRE
SAPHIR
ZAFIRO

120 CM BASE UNIT WITH 2 DRAWERS + 2 INTERIOR DRAWERS - EGGPLANT | GAUDI 120 CM MIRROR - EGGPLANT
ICE DUO 120 CM CAST MINERAL WASHBASIN | 2 SUN LIGHT FIXTURES | 2 PIXEL SINGLE LEVER BASIN MIXERS
MEUBLE 120 CM AVEC 2 TIROIRS + 2 TIROIRS INTERIEURS - AUBERGINE | GAUDI MIROIR 120 CM - AUBERGINE
ICE DUO PLAN VASQUE MINERAL 120 CM | 2 SUN APPLIQUES | 2 PIXEL MITTIGEURS LAVABO
MUEBLE 120 CM CON 2 CAJONES + 2 CAJONES INTERIORES - BERENJENA | GAUDI ESPEJO 120 CM - BERENJENA
ICE DUO LAVABO DE CARGA MINERAL 120CM | 2 APLIQUES SUN | 2 MONOMANDO DE LAVABO PIXEL

bellian

GAUDI

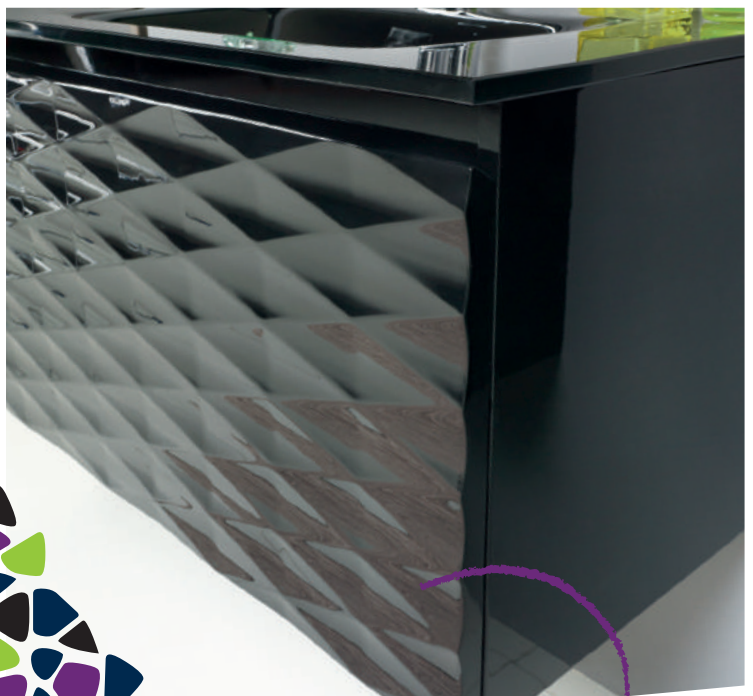

With Valchromat relief, an excellent material with distinctive finish.
Avec relief en Valchromat, un excellent matériel avec finition distinctive.
Con relieve en Valchromat, un excelente material con acabado distintivo.



BASE UNIT WITH DRAWERS + INTERIOR DRAWERS
 MEUBLE AVEC TIROIRS + TIROIRS INTÉRIEURS
 MUEBLE CON CAJONES + CAJONES INTERIORES

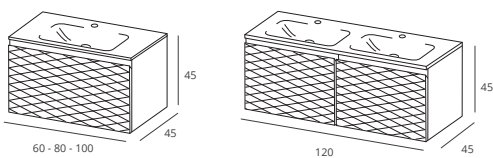

** 2 BOWLS // 2 CUVES // 2 PIAS

WITH WASHBASIN // AVEC VASQUE // CON LAVABO			WITH WASHBASIN // AVEC VASQUE // CON LAVABO		
GLASS // VERRE // CRISTAL	CERAMIC CERAMIQUE PORCELANA (MODERN)	MINERAL FILLER CHARGE MINÉRALE (ICE)	GLASS // VERRE // CRISTAL	CERAMIC CERAMIQUE PORCELANA (MODERN)	MINERAL FILLER CHARGE MINÉRALE (ICE)
60					
80					
100					
120*					

GAUDI

MIRROR // MIROIR // ESPEJO

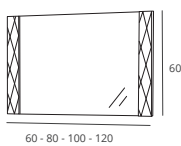

60	
80	
100	
120	

CABINET WHIT 2 DOORS
 COLONNE AVEC 2 PORTES
 COLUMNA CON 2 PUERTAS

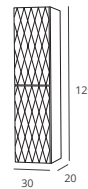

30	

LINE // LINE II

LED LIGHT FIXTURE // APLIQUE LED // APLIQUE LED

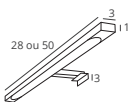

28	
50	

LYRA // LYRA II

LED LIGHT FIXTURE // APLIQUE LED // APLIQUE LED

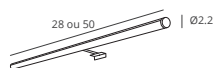

28	
50	

SUN

LED LIGHT FIXTURE // APLIQUE LED // APLIQUE LED

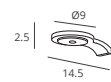

Ø9	
----	--



80 CM BASE UNIT WITH 1 DRAWER - BLACK | CABINET WITH 2 DOORS - BLACK | GAUDI 80 CM MIRROR - BLACK
 VIDRO 81 CM GLASS COUNTERTOP WASHBASIN | LYRA 28 CM LED LIGHT FIXTURE | STRAW SINGLE LEVER BASIN MIXER
 MEUBLE 80 CM AVEC 1 TIROIR - NOIR | COLONNE AVEC 2 PORTES - NOIR | GAUDI MIROIR 80 CM - NOIR
 VIDRO PLAN VASQUE EN VERRE 81 CM | LYRA APPLIQUE LED 28 CM | STRAW MITIGEUR LAVABO
 MUEBLE 80 CM CON 1 CAJON - NEGRO | COLUMNA CON 2 PORTES - NEGRO | GAUDI ESPEJO 80 CM - NEGRO
 VIDRO LAVABO DE CRISTAL DE ENCIMERA 81CM | LYRA APLIQUE LED 28 CM | STRAW MONOMANDO DE LAVABO



80 CM BASE UNIT WITH 1 DRAWER + INTERIOR DRAWER - WHITE | LISO 80 CM MIRROR VIDRO 81 CM GLASS COUNTERTOP WASHBASIN | ALTAIR LED LIGHT FIXTURE | NEXT SINGLE LEVER BASIN MIXER MEUBLE 80 CM AVEC 1 TIROIR + TIROIR INTÉRIEUR - BLANC | LISO MIROIR 80 CM VIDRO PLAN VASQUE EN VERRE 81 CM | ALTAIR APLIQUE LED | NEXT MITIGEUR LAVABO MUEBLE 80 CM CON 1 CAJON + CAJON INTERIOR - BLANCO | LISO ESPEJO 80 CM VIDRO LAVABO DE CRISTAL DE ENCIMERA 81 CM | ALTAIR APLIQUE LED | NEXT MONOMANDO DE LAVABO



60 CM BASE UNIT WITH 1 DRAWER + INTERIOR DRAWER - BEIGE | SILVER 60 CM MIRROR ICE 60 CM CAST MINERAL COUNTERTOP WASHBASIN | KEEN SINGLE LEVER BASIN MIXER MEUBLE 60 CM AVEC 1 TIROIR + TIROIR INTÉRIEUR - BEIGE | SILVER MIROIR 60 CM ICE PLAN VASQUE MINÉRALE 60 CM | KEEN MITIGEUR LAVABO MUEBLE 60 CM CON 1 CAJON + CAJON INTERIOR - BEIGE | SILVER ESPEJO 60 CM ICE LAVABO DE CARGA MINERAL 60 CM | KEEN MONOMANDO DE LAVABO

BASE UNIT WITH DRAWERS + INTERIOR DRAWERS
MEUBLE AVEC TIROIRS + TIROIRS INTÉRIEURS
MUEBLE CON CAJONES + CAJONES INTERIORES

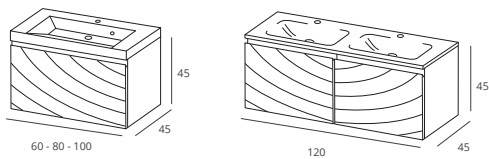

** 2 BOWLS // 2 CUVES // 2 PIAS

WITH WASHBASIN // AVEC VASQUE // CON LAVABO			WITH WASHBASIN // AVEC VASQUE // CON LAVABO		
GLASS // VERRE // CRISTAL	CERAMIC CERAMIQUE PORCELANA (MODERN)	MINERAL FILLER CHARGE MINÉRALE CARGA MINERAL (ICE)	GLASS // VERRE // CRISTAL	CERAMIC CERAMIQUE PORCELANA (MODERN)	MINERAL FILLER CHARGE MINÉRALE CARGA MINERAL (ICE)
60					
80					
100					
120**					

LESS // LESS LEDS
MIRROR // MIROIR // ESPEJO

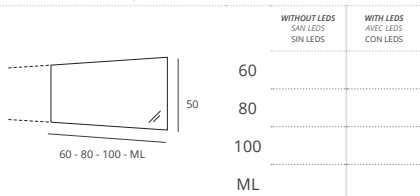

GOLD SCRATCHED // SILVER SCRATCHED
MIRROR // MIROIR // ESPEJO

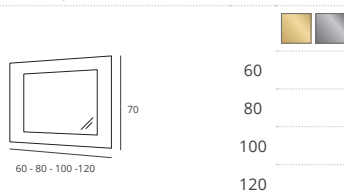

GOLD // SILVER
MIRROR // MIROIR // ESPEJO

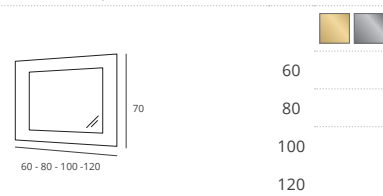

ALTAIR
LED LIGHT FIXTURE // APLIQUE LED // APLIQUE LED



LINE // LINE II
LED LIGHT FIXTURE // APLIQUE LED // APLIQUE LED



LYRA // LYRA II
LED LIGHT FIXTURE // APLIQUE LED // APLIQUE LED

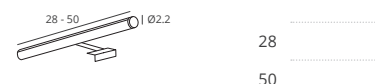



100 CM BASE UNIT WITH 1 DRAWER + INTERIOR DRAWER - PRETO | SILVER BLACK 100 CM MIRROR
 VIDRO 101 CM GLASS COUNTERTOP WASHBASIN | NEXT SINGLE LEVER BASIN MIXER
 MEUBLE 100 CM AVEC 1 TIROIR + TIROIR INTÉRIEUR - NOIR | SILVER BLACK MIROIR 100 CM
 VIDRO PLAN VASQUE EN VERRE 101 CM | NEXT MITIGEUR LAVABO
 MUEBLE 100 CM CON 1 CAJON + CAJON INTERIOR - NEGRO | SILVER BLACK ESPEJO 100 CM
 VIDRO LAVABO DE CRISTAL DE ENCIMERA 101 CM | NEXT MONOMANDO DE LAVABO



60 CM BASE UNIT WITH 2 DRAWERS - WHITE AND LEATHER | LISTA 60 CM MIRROR - LEATHER | VIDRO 61 CM GLASS COUNTERTOP WASHBASIN | VERO CHROMED LIGHT FIXTURE | SMART SINGLE LEVER BASIN MIXER
 MEUBLE 60 CM AVEC 2 TIROIRS - BLANC ET CUIR | LISTA MIROIR 60 CM - CUIR | VIDRO PLAN VASQUE EN VERRE 61 CM | VERO APPLIQUE CHROMÉ | SMART MITIGEUR LAVABO
 MUEBLE 60 CM CON 2 CAJONES - BLANCO Y CUERO | LISTA ESPEJO 60 CM - CUERO | VIDRO LAVABO DE CRISTAL DE ENCIMERA 61CM | APLIQUE VERO CROMO | SMART MONOMANDO DE LAVABO

LEATHER // CUIR // CUERO



BELLIAN COLOURS // COULEURS BELLIAN // COLORES BELLIAN
 RAL COLOURS // COULEURS RAL // COLORES RAL



DONNA LUX BASE UNIT WITH 2 LEATHER DRAWERS
 DONNA LUX MEUBLE AVEC 2 TIROIRS EN CUIR
 DONNA LUX MUEBLE CON 2 CAJONES EN CUERO

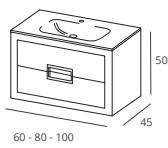

BELLIAN C. + LEATHER // C. BELLIAN + CUIR // C. BELLIAN + CUERO		RAL C. + LEATHER // C. RAL + CUIR // C. RAL + CUERO		GOLD + LEATHER // OR + CUIR // ORO + CUERO		SILVER + LEATHER // ARGENT + CUIR // PLATA + CUERO	
WITH WASHBASIN // AVEC VASQUE // CON LAVABO							
GLASS // VERRE // CRISTAL		CERAMIC CERAMIQUE PORCELANA (MODERN)		GLASS // VERRE // CRISTAL		CERAMIC CERAMIQUE PORCELANA (MODERN)	
60	80	100	60	80	100	60	80

DONNA LUX TALL CABINET WITH 2 LEATHER DOORS
 DONNA LUX COLONNE AVEC 2 PORTES EN CUIR
 DONNA LUX COLUMNA CON 2 PUERTAS EN CUERO

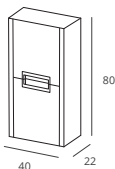

BELLIAN C. + LEATHER // C. BELLIAN + CUIR // C. BELLIAN + CUERO	RAL C. + LEATHER // C. RAL + CUIR // C. RAL + CUERO	GOLD + LEATHER // OR + CUIR // ORO + CUERO	SILVER + LEATHER // ARGENT + CUIR // PLATA + CUERO
40	40	40	40

GOLD SCRATCHED // SILVER SCRATCHED
 MIRROR // MIROIR // ESPEJO

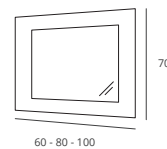

60
80
100

LISTA

MIRROR // MIROIR // ESPEJO

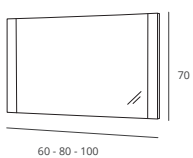

WHITE BLANC	BELLIAN COLOURS COULEURS BELLIAN COLORES BELLIAN	RAL COLOURS COULEURS RAL COLORES RAL	LEATHER CUIR CUERO
60	60	60	60
80	80	80	80
100	100	100	100

LEO

LED LIGHT FIXTURE
 APLIQUE LED // APLIQUE LED



LINE // LINE II

LED LIGHT FIXTURE // APLIQUE LED // APLIQUE LED

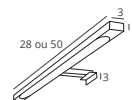

28
50



bellian

DONNA LUX

100 CM BASE UNIT WITH 2 DRAWERS - GOLD AND LEATHER | 2 DOOR CABINET - GOLD AND LEATHER | GOLD SCRATCHED 100 CM MIRROR | VIDRO 101 CM GLASS COUNTERTOP WASHBASIN - BLACK | STAW SINGLE LEVER BASIN MIXER - GOLD
 MEUBLE 100 CM AVEC 2 TIROIRS - OR ET CUIR | COLONNE AVEC 2 PORTES - OR ET CUIR | GOLD SCRATCHED MIROIR 100 CM | VIDRO VASQUE EN VERRE 101 CM - NOIR | STRAW MITIGEUR LAVABO - OR
 MUEBLE 100 CM CON 2 CAJONES - ORO Y CUERO | COLUMNA CON 2 PORTES - ORO Y CUERO | GOLD SCRATCHED ESPEJO 100 CM | VIDRO LAVABO DE CRISTAL DE ENCIMERA 101 CM - NEGRO | STRAW MONOMANDO DE LAVABO - ORO



80 CM BASE UNIT WITH 2 DRAWERS - SILVER AND LEATHER | SILVER SCRATCHED 80 CM MIRROR | VIDRO 81 CM GLASS COUNTERTOP WASHBASIN - BLACK
 SMOOTH SINGLE LEVER BASIN MIXER
 MEUBLE 80 CM AVEC 2 TIROIRS - ARGENT ET CUIR | SILVER SCRATCHED MIROIR 80 CM | VIDRO VASQUE EN VERRE 81 CM - NOIR SMOOTH MITIGEUR LAVABO
 MUEBLE 80 CM CON 2 CAJONES - PLATA Y CUERO | SILVER SCRATCHED ESPEJO 80 CM | SILVER SCRATCHED ESPEJO 80 CM | VIDRO LAVABO DE CRISTAL 81 CM - NEGRO
 SMOOTH MONOMANDO DE LAVABO

LUX

FINISHES // FINITIONS // ACABADOS



GOLD
OR
ORO



SILVER
ARGENT
PLATA



LEATHER
CUIR
CUERO

Lift the luxury of your bathroom space, choosing the drawers with black leather trim that accentuate the distinction of your bathroom cabinet.

Soulevez le luxe de votre espace salle de bain, en choisissant les tiroirs avec garniture en cuir noir qui accentuent la distinction de votre meuble de bains.

Eleve el lujo de su espacio de baño, eligiendo los cajones con acabado de cuero negro, que acentúan la distinción de su mueble de baño.

MIRROR CABINETS

SEE THE FULL RANGE ON PAGE 152

ARMOIRES AVEC MIROIR

VOIR LA GAMME COMPLÈTE SUR LA PAGE 152

ARMARIOS CON ESPEJO

VER LA GAMA COMPLETA EN LA PÁGINA 152



80 CM BASE UNIT WITH 2 DRAWERS - WHITE | 60 CM MIRROR CABINET - WHITE | MODERN 81 CM CERAMIC COUNTERTOP WASHBASIN | SMART SINGLE LEVER BASIN MIXER
 MEUBLE 80 CM AVEC 2 TIROIRS - BLANC | ARMOIRE DE TOILETTE 60 CM - BLANC | MODERN PLAN VASQUE EN CÉRAMIQUE 81 CM | SMART MITTIGEUR LAVABO
 MUEBLE 80 CM CON 2 CAJONES - BLANCO | ARMARIO CON ESPEJOS 60 CM - BLANCO | MODERN LAVABO DE PORCELANA DE ENCIMERA 81 CM | SMART MONOMANDO DE LAVABO

BASE UNIT WITH 2 DRAWERS

MEUBLE AVEC 2 TIROIRS
 MUEBLE CON 2 CAJONES

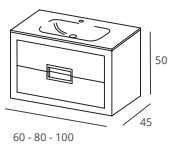

BELLIAN COLOURS // COULEURS BELLIAN // COLORES BELLIAN		RAL COLOURS // COULEURS RAL // COLORES RAL	
WITH WASHBASIN // AVEC VASQUE // CON LAVABO			
GLASS // VERRE // CRISTAL	CERAMIC CERAMIQUE PORCELANA (MODERN)	GLASS // VERRE // CRISTAL	CERAMIC CERAMIQUE PORCELANA (MODERN)
60			
80			
100			

TALL CABINET WITH 2 DOORS

COLONNE AVEC 2 PORTES
 COLUMNA CON 2 PUERTAS

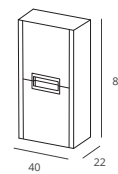

BELLIAN COLOURS COULEURS BELLIAN COLORES BELLIAN	RAL COLOURS COULEURS RAL COLORES RAL
40	

LISTA

MIRROR // MIROIR // ESPEJO

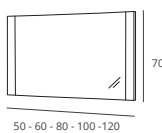

WHITE BLANC BLANCO	BELLIAN COLOURS COULEURS BELLIAN COLORES BELLIAN	RAL COLOURS COULEURS RAL COLORES RAL
60		
80		
100		

PRACTICAL

MIRROR CABINETS // ARMOIRES DE TOILETTE // ARMARIOS CON ESPEJOS

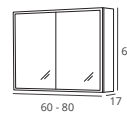

(2 DOORS // 2 PORTES // 2 PUERTAS)

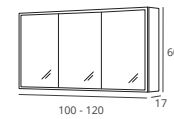

(3 DOORS // 3 PORTES // 3 PUERTAS)

60
80
100
120

ALTAIR

LED LIGHT FIXTURE // APPLIQUE LED // APLIQUE LED

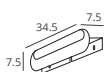

34.5

LINE // LINE II

LED LIGHT FIXTURE // APPLIQUE LED // APLIQUE LED



28

50

LYRA // LYRA II

LED LIGHT FIXTURE // APPLIQUE LED // APLIQUE LED

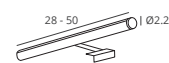

28

50



60 CM BASE UNIT WITH 2 DRAWERS - WHITE AND EGGPLANT | LISO MIRROR WITH CHROME FRAME | MODERN 61 CM CERAMIC COUNTERTOP WASHBASIN | NEXT SINGLE LEVER BASIN MIXER | VERO LED LIGHT FIXTURE
 MEUBLE 60 CM AVEC 2 TIROIRS - BLANC ET AUBERGINE | LISO MIROIR AVEC CADRE CHROMÉ | MODERN PLAN VASQUE EN CÉRAMIQUE 61 CM | NEXT MITIGEUR LAVABO | VERO APPLIQUE LED
 MUEBLE 60 CM CON 2 CAJONES - BLANCO ET BERENJENA | LISO ESPEJO CON MARCO CROMO | MODERN LAVABO DE PORCELANA DE ENCIMERA 61CM | NEXT MONOMANDO DE LAVABO | VERO APLIQUE LED



100 CM BASE UNIT WITH 2 DRAWERS - BORDEAUX | TALL CABINET W/ 2 DOORS - BORDEAUX | VIDRO 101 CM GLASS COUNTERTOP WASHBASIN | LISTA MIRROR 100 CM - BORDEAUX | SMART SINGLE LEVER BASIN MIXER
 MEUBLE 100 CM AVEC 2 TIROIRS - BORDEAUX | COLONNE A/ 2 PORTES - BORDEAUX | LISTA MIROIR 100 CM - BORDEAUX | VIDRO PLAN VASQUE EN VERRE 101 CM | SMART MITIGEUR LAVABO | LINE APPLIQUE LED
 MUEBLE 100 CM CON 2 CAJONES - BORDEAUX | COLUMNA CON 2 PORTES - BORDEAUX | LISTA ESPEJO 100 CM - BORDEAUX | VIDRO LAVABO DE CRISTAL DE ENCIMERA 101CM | SMART MONOMANDO DE LAVABO
 LINE APLIQUE LED



MINI // 22
 REDUCED DEPTH
 PROFONDEUR RÉDUITE
 PROFUNDIDAD REDUCIDA

NICE

40 CM BASE UNIT WITH 1 DOOR - BLACK | INDY MIRROR Ø35 CM | NICE MINERAL COUNTERTOP WASHBASIN | KEEN SINGLE LEVER BASIN MIXER
 MEUBLE 40 CM AVEC 1 PORTE - NOIR | INDY MIROIR Ø35 CM | NICE PLAN VASQUE EN MINERAL | KEEN MITIGEUR LAVABO
 MUEBLE 40 CM CON 1 PUERTA - NEGRO | INDY ESPEJO Ø35 CM | NICE LAVABO INTEGRAL DE CARGA MINERAL | KEEN MONOMANDO DE LAVABO



NICE BASE UNIT WITH 1 DOOR AND NICE WASHBASIN
 MEUBLE NICE AVEC 1 PORTE ET VASQUE NICE
 MUEBLE NICE CON 1 PUERTA Y LAVABO NICE

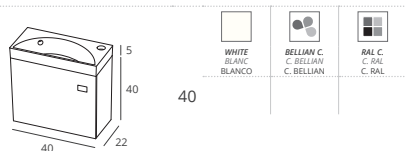

SWEET BASE UNIT WITH 1 DOOR AND SWEET WASHBASIN
 MEUBLE SWEET AVEC 1 PORTE ET VASQUE SWEET
 MUEBLE SWEET CON 1 PUERTA Y LAVABO SWEET

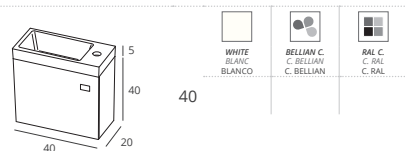

SMART
 REVERSIBLE MIRROR // MIROIR REVERSIBLE // ESPEJO REVERSIBLE

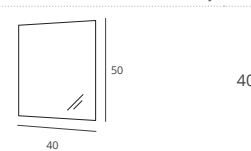

SUN
 LED LIGHT FIXTURE // APPLIQUE LED // APLIQUE LED



LINE
 LED LIGHT FIXTURE // APPLIQUE LED // APLIQUE LED

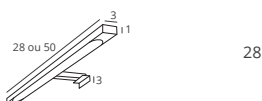

INDY
 MIRROR // MIROIR // ESPEJO



MINI  20
 REDUCED DEPTH
 PROFONDEUR RÉDUITE
 PROFUNDIDAD REDUCIDA

40 CM BASE UNIT WITH 1 DOOR - SAPPHIRE | SMART MIRROR 40CM | SWEET MINERAL COUNTERTOP WASHBASIN | KEEN SINGLE LEVER BASIN MIXER
 MEUBLE 40 CM AVEC 1 PORTE - SAPHIR | SMART MIROIR 40 CM | SWEET PLAN VASQUE EN MINERAL | KEEN MITIGEUR LAVABO
 MUEBLE 40 CM CON 1 PUERTA - ZAFIRO | SMART ESPEJO 40 CM | SWEET LAVABO INTEGRAL DE CARGA MINERAL | KEEN MONOMANDO DE LAVABO

MINI 

**SOLUTIONS
FOR SMALL SPACES**

Our solutions for small spaces offer elegance and simplicity to your space.

**SOLUTIONS
POUR LES PETITS ESPACES**

Nos solutions pour les petits espaces offrent élégance et simplicité à votre espace.

**SOLUCIONES
PARA ESPACIOS PEQUEÑOS**

Nuestras soluciones para espacios pequeños ofrecen elegancia y la simplicidad a su espacio

SWEET





MINI 28
 REDUCED DEPTH
 PROFONDEUR RÉDUITE
 PROFUNDIDAD REDUCIDA

45 CM BASE UNIT WITH 1 DOOR - BLACK | FIORE MIRROR 20 CM | FIORE COUNTERTOP WASHBASIN
 FONT SINGLE LEVER BASIN MIXER | CUBE HALOGEN LIGHT FIXTURE
 MEUBLE 45 CM AVEC 1 PORTE - NOIR | FIORE MIROIR 20 CM | FIORE PLAN VASQUE
 FONT MITIGEUR LAVABO | CUBE APPLIQUE HALOGÈNE
 MUEBLE 45 CM CON 1 PUERTA - NEGRO | FIORE ESPEJO 20 CM | FIORE LAVABO DE ENCIMERA
 FONT MONOMANDO DE LAVABO | CUBE APLIQUE HALÓGENO



BASE UNIT WITH 1 DOOR AND NICE WASHBASIN
 MEUBLE AVEC 1 PORTE ET VASQUE NICE
 MUEBLE CON 1 PUERTA Y LAVABO NICE

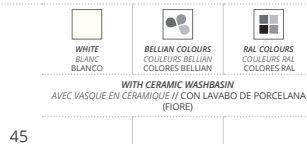
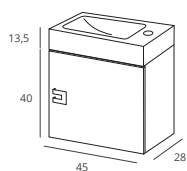

FIORE
 REVERSIBLE MIRROR
 MIROIR REVERSIBLE // ESPEJO REVERSIBLE

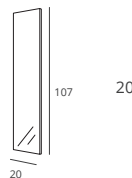

CUBE M
 HALOGEN LIGHT FIXTURE
 APPLIQUE HALOGÈNE // APLIQUE HALÓGENO

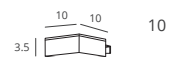

MINI 32
 REDUCED DEPTH
 PROFONDEUR RÉDUITE
 PROFUNDIDAD REDUCIDA



40 CM BASE UNIT WITH 1 DOOR - WHITE | SMART MIRROR 40 CM | SMART GLASS COUNTERTOP WASHBASIN 41 CM - BLACK
 SMART SINGLE LEVER BASIN MIXER | CUBE HALOGEN LIGHT FIXTURE
 MEUBLE 40 CM AVEC 1 PORTE - BLANC | SMART MIROIR 40 CM | SMART PLAN VASQUE EN VÉRRE 41 CM - NOIR
 SMART MITIGEUR LAVABO | CUBE APPLIQUE HALOGENE
 MUEBLE 40 CM CON 1 PUERTA - NEGRO | SMART ESPEJO 40 CM | SMART LAVABO DE CRISTA DE ENCIMERA 41 CM - NEGRO
 SMART MONOMANDO DE LAVABO | CUBE APLIQUE HALÓGENO

SMART

REVERSIBLE MIRROR
 MIROIR REVERSIBLE // ESPEJO REVERSIBLE

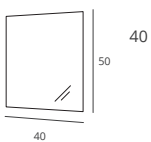

CUBE M

HALOGEN LIGHT FIXTURE
 APPLIQUE HALOGENE // APLIQUE HALÓGENO



BASE UNIT WITH 1 DOOR AND SMART WASHBASIN

MEUBLE AVEC 1 PORTE ET VASQUE SMART
 MUEBLE CON 1 PUERTA Y LAVABO SMART

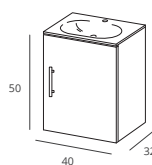

WHITE BLANC BLANCO		BELLIAN COLOURS COULEURS BELLIAN COLORES BELLIAN			RAL COLOURS COULEURS RAL COLORES RAL		
WITH GLASS WASHBASIN // AVEC VASQUE EN VÉRRE // CON LAVABO DE CRISTAL (SMART)							
WHITE OXIDE BLANC OXYDE BLANCO OXIDO	BLACK NOIR NEGRO	GOLD OR ORO	WHITE OXIDE BLANC OXYDE BLANCO OXIDO	BLACK NOIR NEGRO	GOLD OR ORO	WHITE OXIDE BLANC OXYDE BLANCO OXIDO	BLACK NOIR NEGRO



MINI 32
 REDUCED DEPTH
 PROFONDEUR RÉDUITE
 PROFUNDIDAD REDUCIDA



40 CM BASE UNIT WITH 1 DOOR - WHITE | SMART MIRROR 40 CM | SMART GLASS COUNTERTOP WASHBASIN 41 CM - WHITE OXIDE | GOAL SINGLE LEVER BASIN MIXER | BELL HALOGEN LIGHT FIXTURE
 MEUBLE 40 CM AVEC 1 PORTE - BLANC | SMART MIROIR 40 CM | SMART PLAN VASQUE EN VERRE - BLANC OXYDE
 GOAL MITIGEUR LAVABO | BELL APPLIQUE HALOGÈNE
 MUEBLE 40 CM CON 1 PUERTA - BLANCO | SMART ESPEJO 20 CM | SMART LAVABO DE CRISTAL DE ENCIMERA 41 CM - BLANCO ÓXIDO | GOAL MONOMANDO DE LAVABO | BELL APLIQUE HALÓGENO

40 CM BASE UNIT WITH 1 DOOR - BLACK | SMART MIRROR 40 CM | SMART GLASS COUNTERTOP WASHBASIN 41 CM - BLACK GOAL SINGLE LEVER BASIN MIXER | BELL HALOGEN LIGHT FIXTURE
 MEUBLE 40 CM AVEC 1 PORTE - NOIR | SMART MIROIR 40 CM | SMART PLAN VASQUE EN VERRE - NOIR
 GOAL MITIGEUR LAVABO | BELL APPLIQUE HALOGÈNE
 MUEBLE 40 CM CON 1 PUERTA - NEGRO | SMART ESPEJO 20 CM | SMART LAVABO DE CRISTAL DE ENCIMERA 41 CM - NEGRO | GOAL MONOMANDO DE LAVABO | BELL APLIQUE HALÓGENO

MINI

BIG SOLUTIONS FOR SMALL SPACES

With Bellian® MINI models, find the right solution for your smaller bathroom space, through simplicity and refinement. Meet our MINI ranges throughout the catalog marked with the icon "MINI".

GRANDES SOLUTIONS POUR LES PETITS ESPACES

Avec les modèles MINI de Bellian®, trouvez la bonne solution pour votre petite salle de bains, grâce à la simplicité et le raffinement. Rencontrez nos gammes MINI au long de tout le catalogue marqués avec l'icône "MINI".

GRANDES SOLUCIONES PARA ESPACIOS PEQUEÑOS

Con los modelos MINI de Bellian®, encontrará la solución adecuada para su espacio de baño más pequeño, a través de la sencillez y refinamiento. Conozca nuestras gamas MINI en todo el catálogo identificadas con el ícono "MINI".

BASE UNIT WITH 1 DOOR AND SMART WASHBASIN
 MEUBLE AVEC 1 PORTE ET VASQUE SMART
 MUEBLE CON 1 PUERTA Y LAVABO SMART

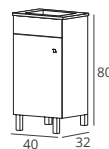

WHITE BLANC BLANCO		BELLIAN COLOURS COULEURS BELLIAN COLORES BELLIAN			RAL COLOURS COULEURS RAL COLORES RAL			
WITH GLASS WASHBASIN // AVEC VASQUE EN CÉRAMIQUE // CON LAVABO DE PORCELANA (SMART)								
WHITE OXIDE BLANC OXYDE BLANCO ÓXIDO	BLACK NOIR NEGRO	GOLD OR ORO	WHITE OXIDE BLANC OXYDE BLANCO ÓXIDO	BLACK NOIR NEGRO	GOLD OR ORO	WHITE OXIDE BLANC OXYDE BLANCO ÓXIDO	BLACK NOIR NEGRO	GOLD OR ORO

SMART
 REVERSIBLE MIRROR // MIROIR REVERSIBLE // ESPEJO REVERSIBLE

BELL
 HALOGEN LIGHT FIXTURE // APPLIQUE HALOGÈNE // APLIQUE HALÓGENO

LEO
 LED LIGHT FIXTURE // APPLIQUE LED // APLIQUE LED

MINI ³²
 REDUCED DEPTH
 PROFONDEUR RÉDUITE
 PROFUNDIDAD REDUCIDA



40 CM BASE UNIT WITH 1 DOOR - WHITE | SMART MIRROR 40 CM | SMART GLASS COUNTERTOP WASHBASIN 41 CM - BLACK
 GOAL SINGLE LEVER BASIN MIXER | BELL HALOGEN LIGHT FIXTURE
 MEUBLE 40 CM AVEC 1 PORTE - BLANC | SMART MIROIR 40 CM | SMART PLAN VASQUE EN VERRE - NOIR
 GOAL MITIGEUR LAVABO | BELL APPLIQUE HALOGÈNE
 MUEBLE 40 CM CON 1 PUERTA - BLANCO | SMART ESPEJO 20 CM | SMART LAVABO DE CRISTAL DE ENCIMERA 41 CM - NEGRO | GOAL
 MONOMANDO DE LAVABO | BELL APLIQUE HALÓGENO

40 CM BASE UNIT WITH 1 DOOR - SAPPHIRE | SMART MIRROR 40 CM | SMART GLASS COUNTERTOP WASHBASIN 41 CM - WHITE OXYDE
 GOAL SINGLE LEVER BASIN MIXER | BELL HALOGEN LIGHT FIXTURE
 MEUBLE 40 CM AVEC 1 PORTE - SAPHIR | SMART MIROIR 40 CM | SMART PLAN VASQUE EN VERRE - BLANC OXIDE
 GOAL MITIGEUR LAVABO | BELL APPLIQUE HALOGÈNE
 MUEBLE 40 CM CON 1 PUERTA - ZAFIRO | SMART ESPEJO 20 CM | SMART LAVABO DE CRISTAL DE ENCIMERA 41 CM - BLANCO ÓXIDO
 GOAL MONOMANDO DE LAVABO | BELL APLIQUE HALÓGENO

BASE UNIT WITH 1 DOOR AND SMART WASHBASIN
 MEUBLE AVEC 1 PORTE ET VASQUE SMART
 MUEBLE CON 1 PUERTA Y LAVABO SMART

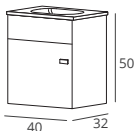

WHITE BLANC BLANCO			BELLIAN COLOURS COULEURS BELLIAN COLORES BELLIAN			RAL COLOURS COULEURS RAL COLORES RAL		
WITH GLASS WASHBASIN // AVEC VASQUE EN VERRE // CON LAVABO DE PORCELANA (SMART)								
WHITE OXIDE BLANC OXYDE BLANCO ÓXIDO	BLACK NOIR NEGRO	GOLD OR ORO	WHITE OXIDE BLANC OXYDE BLANCO ÓXIDO	BLACK NOIR NEGRO	GOLD OR ORO	WHITE OXIDE BLANC OXYDE BLANCO ÓXIDO	BLACK NOIR NEGRO	GOLD OR ORO

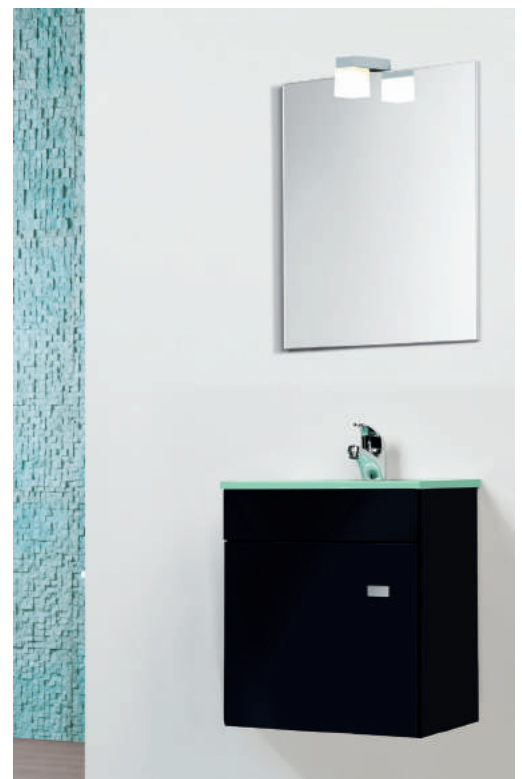

SMART
 REVERSIBLE MIRROR // MIROIR REVERSIBLE // ESPEJO REVERSIBLE

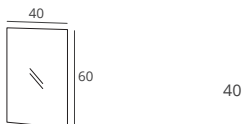

BELL
 HALOGEN LIGHT FIXTURE // APPLIQUE HALOGÈNE // APLIQUE HALÓGENO

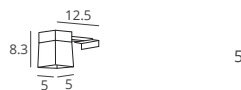

LEO
 LED LIGHT FIXTURE // APPLIQUE LED // APLIQUE LED

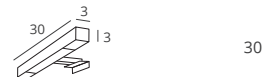



SHIFT

SET OF 2 FEET // LOT DE 2 PIEDS // CONJUNTO DE 2 PATAS



BELLIAN COLOURS
COULEURS BELLIAN
COLORES BELLIAN



RAL COLOURS
COULEURS RAL
COLORES RAL



BASE UNIT WITH 2 DRAWERS, COUNTERTOP WASHBASIN AND 2 BELLIAN COLOUR FEET

MEUBLE AVEC 2 TIROIRS, LAVABO ET 2 PIEDS EN BELLIAN COULEUR
MUEBLE CON 2 CAJONES, LAVABO Y 2 PATAS EN COLOR BELLIAN

60 - 80 - 100 - 120
50
45

WHITE // BLANC // BLANCO		BELLIAN COLOURS // COULEURS BELLIAN // COLORES BELLIAN		CHERRY // CERISE // CEREZO		G. WENGE // WENGÉ G. // WENGER G.		RAL COLOURS // COULEURS RAL // COLORES RAL	
WITH WASHBASIN // AVEC VASQUE // CON LAVABO		WITH WASHBASIN // AVEC VASQUE // CON LAVABO		WITH WASHBASIN // AVEC VASQUE // CON LAVABO		WITH WASHBASIN // AVEC VASQUE // CON LAVABO		WITH WASHBASIN // AVEC VASQUE // CON LAVABO	
GLASS // VERRE // CRISTAL	CERAMIC CERAMIQUE PORCELANA	GLASS // VERRE // CRISTAL	CERAMIC CERAMIQUE PORCELANA	GLASS // VERRE // CRISTAL	CERAMIC CERAMIQUE PORCELANA	GLASS // VERRE // CRISTAL	CERAMIC CERAMIQUE PORCELANA	GLASS // VERRE // CRISTAL	CERAMIC CERAMIQUE PORCELANA
60									
80									
100									
120*									
120**									

* 1 BOWL // 1 CUVE // 1 PIA ** 2 BOWLS // 2 CUVES // 2 PIAS

SUSPENDED BASE UNIT WITH 2 DRAWERS AND COUNTERTOP WASHBASIN

MEUBLE SUSPENDU AVEC 2 TIROIRS ET LAVABO
MUEBLE SUSPENDIDO CON 2 CAJONES Y LAVABO

60 - 80 - 100 - 120
50
45

WHITE // BLANC // BLANCO		BELLIAN COLOURS // COULEURS BELLIAN // COLORES BELLIAN		CHERRY // CERISE // CEREZO		G. WENGE // WENGÉ G. // WENGER G.		RAL COLOURS // COULEURS RAL // COLORES RAL	
WITH WASHBASIN // AVEC VASQUE // CON LAVABO		WITH WASHBASIN // AVEC VASQUE // CON LAVABO		WITH WASHBASIN // AVEC VASQUE // CON LAVABO		WITH WASHBASIN // AVEC VASQUE // CON LAVABO		WITH WASHBASIN // AVEC VASQUE // CON LAVABO	
GLASS // VERRE // CRISTAL	CERAMIC CERAMIQUE PORCELANA	GLASS // VERRE // CRISTAL	CERAMIC CERAMIQUE PORCELANA	GLASS // VERRE // CRISTAL	CERAMIC CERAMIQUE PORCELANA	GLASS // VERRE // CRISTAL	CERAMIC CERAMIQUE PORCELANA	GLASS // VERRE // CRISTAL	CERAMIC CERAMIQUE PORCELANA
60									
80									
100									
120*									
120**									

* 1 BOWL // 1 CUVE // 1 PIA ** 2 BOWLS // 2 CUVES // 2 PIAS

COOL

MIRROR WITH LEDS // MIROIR AVEC LEDS // ESPEJO CON LEDS

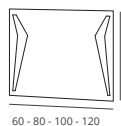

LISO

MIRROR WITH CHROMED FRAME
MIROIR AVEC CADRE CHROMÉ // ESPEJO CON MARCO CROMO

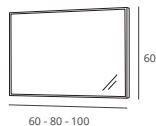

LYRA // LYRA II

LED LIGHT FIXTURE // APLIQUE LED // APLIQUE LED

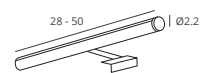

28
50



120 CM BASE UNIT WITH 2 DRAWERS - WHITE | SET OF 2 FEET - BLACK | GLASS COUNTERTOP WASHBASIN 121 CM - BLACK
 PIXEL - SINGLE LEVER BASIN MIXER | COOL - MIRROR WITH LEDS 120 CM
 MEUBLE 120 CM AVEC 2 TIROIRS - BLANC | LOT DE 2 PIEDS | PLAN VASQUE EN VERRE 121 CM - NOIR
 PIXEL - MITIGEUR LAVABO | COOL MIROIR AVEC LEDS 100 CM
 MUEBLE 120 CM CON 2 CAJONES - BLANCO | CONJUNTO DE 2 PATAS | LAVABO DE CRISTAL 121 CM - NEGRO | PIXEL LAVABO
 MONOMANDO | COOL ESPEJO CON LEDS 121 CM

bellian
SHIFT



80 CM BASE UNIT WITH 2 DRAWERS - BELLIAN RED | FLUX CERAMIC COUNTERTOP WASHBASIN 81 CM | NIX - SINGLE LEVER BASIN MIXER | LIGHT H IP44 MIRROR
 MEUBLE 80 CM AVEC 2 TIROIRS - ROUGE BELLIAN | PLAN VASQUE EN CÉRAMIQUE 81 CM | NIX - MITTGEUR LAVABO | MIROIR LIGHT H IP44
 MUEBLE 80 CM CON 2 CAJONES - ROJO | LAVABO INTEGRAL DE PORCELANA | NIX LAVABO MONOMANDO | ESPEJO LIGHT H IP44

SUSPENDED BASE UNIT WITH 2 DRAWERS AND COUNTERTOP WASHBASIN
 MEUBLE SUSPENDU AVEC 2 TIROIRS ET LAVABO
 MUEBLE SUSPENDIDO CON 2 CAJONES Y LAVABO

	WHITE // BLANC // BLANCO WITH FLUX WASHBASIN AVEC VASQUE FLUX // CON LAVABO FLUX	BELLIAN COLOURS // COULEURS BELLIAN // COLORES BELLIAN WITH FLUX WASHBASIN AVEC VASQUE FLUX // CON LAVABO FLUX	RAL COLOURS // COULEURS RAL // COLORES RAL WITH FLUX WASHBASIN AVEC VASQUE FLUX // CON LAVABO FLUX
	GLASS // VERRE // CRISTAL CERAMIC CÉRAMIQUE PORCELANA	GLASS // VERRE // CRISTAL CERAMIC CÉRAMIQUE PORCELANA	GLASS // VERRE // CRISTAL CERAMIC CÉRAMIQUE PORCELANA

TALL CABINET WITH 2 DOORS
 COLONNE AVEC 2 PORTES
 COLUMNNA CON 2 PUERTAS

	WHITE BLANC BLANCO	BELLIAN C C. BELLIAN C. BELLIAN	RAL COLOURS COULEURS RAL COLORES RAL

LIGHT H
 MIRROR WITH FLUORESCENT LIGHTING
 MIROIR AVEC ÉCLAIRAGE FLUORESCENTE
 ESPEJO CON ILUMINACIÓN FLUORESCENTE

	60	80	100

LISO
 MIRROR WITH CHROMED FRAME
 MIROIR AVEC CADRE CHROMÉ
 ESPEJO CON MARCO CROMO

	60	80	100

LYRA // LYRA II
 LED LIGHT FIXTURE // APLIQUE LED // APLIQUE LED

	LED
	28
	50



100 CM BASE UNIT WITH 2 DRAWERS - WHITE | FLUX CERAMIC COUNTERTOP WASHBASIN 101 CM | TALL CABINET WITH 2 DOORS - WHITE | NIX - SINGLE LEVER BASIN MIXER | SLEEK MIRROR WITH LEDS
 MEUBLE 100 CM AVEC 2 TIROIRS - WHITE | FLUX PLAN VASQUE EN CÉRAMIQUE 101 CM | COLONNE AVEC 2 PORTES - WHITE | NIX - MITIGEUR LAVABO | SLEEK MIROIR AVEC LEDS
 MUEBLE 100 CM CON 2 CAJONES - BLANCO | FLUX LAVABO INTEGRAL DE PORCELANA | NIX LAVABO MONOMANDO | SLEEK ESPEJO CON LEDS

QUALITY & ROBUST

NINNA is distinguished by the quality of its construction with the cabinet drawers and the column doors with a thickness of 40mm. The hinges of column door could open up to 180 degrees.

QUALITÉ ET RÉSISTANCE

NINNA se distingue par la qualité de sa construction avec tiroirs du meuble et les portes de la colonne avec une épaisseur de 40 mm. Les charnières de la porte de la colonne permettent l'ouverture jusqu'à 180 degrés.

CALIDAD Y SÓLIDEZ

NINNA se distingue por la calidad de su construcción con los cajones del mueble y las puertas de la columna con un espesor de 40mm. Las bisagras de la puerta de la columna hacen una apertura hasta 180°.



Hinges of column door could open up to 180°
 Les charnières de la porte de la colonne permettent l'ouverture jusqu'à 180°
 Las bisagras de la puerta de la columna hacen una paertura hasta 180°



Column doors with a thickness of 40mm.
 Les portes de la colonne avec une épaisseur de 40mm.
 Puertas de la columna con un espesor de 40mm.

MIRROR CABINETS

SEE THE FULL RANGE ON PAGE 152

ARMOIRES AVEC MIROIR

VOIR LA GAMME COMPLÈTE SUR LA PAGE 152

ARMARIOS CON ESPEJO

VER LA GAMA COMPLETA EN LA PÁGINA 152



120 CM BASE UNIT WITH 4 DRAWERS - WHITE | ONDA DUO CERAMIC COUNTERTOP WASHBASIN 121CM | 2 UNITS HARPA - SINGLE LEVER BASIN MIXER | PRACTICAL MIRROR CABINET 120CM - WHITE
 MEUBLE 120CM AVEC 4 TIROIRS - BLANC | ONDA DUO PLAN VASQUE EN CÉRAMIQUE 121CM | 2 UNITÉS HARPA - MITIGEUR LAVABO | PRACTICAL - ARMOIRE DE TOILETTE 120CM - BLANC
 MUEBLE 120 CM CON 4 CAJONES - BLANCO | ONDA DUO LAVABO INTEGRAL DE PORCELANA 121CM | 2 UNIDADES HARPA - LAVABO MONOMANDO | PRACTICAL - ARMARIO CON ESPEJOS 120CM - BLANCO

SUSPENDED BASE UNIT WITH 2 OR 4 DRAWERS AND COUNTERTOP WASHBASIN

MEUBLE SUSPENDU AVEC 2 OU 4 TIROIRS ET LAVABO
 MUEBLE SUSPENDIDO CON 2 O 4 CAJONES Y LAVABO

WHITE // BLANC // BLANCO		BELLIAN COLOURS // COULEURS BELLIAN // COLORES BELLIAN		RAL COLOURS // COULEURS RAL // COLORES RAL	
WITH WASHBASIN // AVEC VASQUE // CON LAVABO		WITH WASHBASIN // AVEC VASQUE // CON LAVABO		WITH WASHBASIN // AVEC VASQUE // CON LAVABO	
GLASS // VERRE // CRISTAL	CERAMIC CERAMIQUE PORCELANA (MODERN)	GLASS // VERRE // CRISTAL	CERAMIC CERAMIQUE PORCELANA (MODERN)	GLASS // VERRE // CRISTAL	CERAMIC CERAMIQUE PORCELANA (MODERN)
60	80	100	120**		

** 2 BOWLS // 2 CUVES // 2 PIAS

TALL CABINET WITH 1 DOOR + 1 DRAWER

COLONNE AVEC 1 PORTE + 1 TIROIR
 COLUMNA CON 1 PUERTA + 1 CAJÓN

WHITE // BLANC // BLANCO	BELLIAN C. // COULEURS BELLIAN // COLORES BELLIAN	CORES RAL
110	35	
30	35	

PRACTICAL MIRROR CABINETS

ARMOIRES DE TOILETTE // ARMARIOS CON ESPEJOS

WHITE // BLANC // BLANCO
60
80
100
120

60 - 80 (2 DOORS // 2 PORTES // 2 PUERTAS)
 100 - 120 (3 DOORS // 3 PORTES // 3 PUERTAS)

LIGHT H

MIRROR WITH FLUORESCENT LIGHTING
 MIROIR AVEC ÉCLAIRAGE FLUORESCENT
 ESPEJO CON ILUMINACION FLUORESCENTE

	60
	80
	100
	120

60 - 80 - 100 - 120



120 CM BASE UNIT WITH 4 DRAWERS - ANTHRACITE | GLASS COUNTERTOP WASHBASIN 121 CM
 2 UNITS HARPA - SINGLE LEVER BASIN MIXER | PRACTICAL MIRROR CABINET 120 CM
 MEUBLE 120 CM AVEC 4 TIROIRS - ANTHRACITE | PLAN VASQUE EN VERRE 121 CM
 2 UNITÉS HARPA - MITIGEUR LAVABO | PRACTICAL - ARMOIRE DE TOILETTE 120 CM - BLANC
 MUEBLE 120 CM CON 4 CAJONES - ANTRACITE | LAVABO DE CRISTAL DE ENCIMERA 121 CM
 2 UNIDADES HARPA - LAVABO MONOMANDO | PRACTICAL - ARMARIO CON ESPEJOS 120 CM - BLANCO



80CM BASE UNIT WITH 2 DRAWERS - EGGPLANT | ONDA CERAMIC COUNTERTOP WASHBASIN 81CM
 TALL CABINET WITH 1 DOOR AND 1 DRAWER 30CM - EGGPLANT | HARPA - SINGLE LEVER BASIN MIXER
 LIGHT H IP44 MIRROR 80CM
 MEUBLE 80CM AVEC 2 TIROIRS - AUBERGINE | ONDA PLAN VASQUE EN CERAMIQUE 81CM
 COLONNE AVEC 1 PORTE ET 1 TIROIR 30CM - AUBERGINE | HARPA - MITIGEUR LAVABO | MIROIR LIGHT H IP44
 MUEBLE 80CM CON 2 CAJONES - BERENJENA | LAVABO INTEGRAL DE PORCELANA 81CM
 HARPA - LAVABO MONOMANDO | LIGHT H IP44 ESPEJO 80CM



100CM BASE UNIT WITH 2 DRAWERS - BLACK | MODERN CERAMIC COUNTERTOP WASHBASIN 101CM
 NEXT - SINGLE LEVER BASIN MIXER | MIRROR CABINET 100CM - BLACK | LINE II - LED LIGHT FIXTURE
 TALL CABINET WITH 1 DOOR - BLACK
 MEUBLE 100CM AVEC 2 TIROIRS - NOIR | MODERN PLAN VASQUE EN CÉRAMIQUE 101CM | NEXT - MITIGEUR
 LAVABO/ARMOIRE DE TOILETTE 100CM - NOIR | LINE II - APPLIQUE LED | COLONNE AVEC 1 PORTE - NOIR
 MUEBLE 100CM CON 2 CAJONES - NEGRO | MODERN LAVABO INTEGRAL DE PORCELANA 101 CM
 NEXT - LAVABO MONOMANDO | ARMARIO CON ESPEJOS 100 CM - NEGRO | LINE II - APLIQUE LED
 COLUMNA CON 1 PUERTA

**LACQUEREDS
HIGH GLOSS**

All colors are available in high-gloss lacquered, or elect still among the laminated textures Bellian®, the one that best reflects your style.
 In lacquers can find a versatile and practical solution that gives color to your bathroom space, through cozy and modern environments.

**LAQUÉE
HAUTE BRILLANCE**

Toutes les couleurs sont disponibles en laquées haute brillance, ou choisissez parmi les textures lamellés Bellian®, celui qui reflète le mieux votre style.
 Les laquées sont une solution polyvalente et pratique qui donnent la couleur à votre espace salle de bains, grâce à des environnements accueillants et confortables.

**LACADOS
ALTO BRILLO**

Todos los colores están disponibles en lacados de alto brillo, o elige entre las texturas laminadas Bellian®, la que mejor refleje su estilo.
 En los lacados se encuentra una solución versátil y práctica que da color a su espacio de baño, a través de ambientes acogedores y modernos.

SUSPENDED BASE UNIT WITH 2 OR 4 DRAWERS AND COUNTERTOP WASHBASIN
 MEUBLE SUSPENDU AVEC 2 OU 4 TIROIRS ET LAVABO
 MUEBLE SUSPENDIDO CON 2 O 4 CAJONES Y LAVABO

	WHITE // BLANC // BLANCO	CHERRY // CÉRISSE // CEREZO	G. WENGE // WENGE G. // WENGER G.	BELLIAN COLOURS // COULEURS BELLIAN // COLORES BELLIAN	RAL COLOURS // COULEURS RAL // COLORES RAL
60	WITH WASHBASIN // AVEC VASQUE // CON LAVABO	WITH WASHBASIN // AVEC VASQUE // CON LAVABO	WITH WASHBASIN // AVEC VASQUE // CON LAVABO	WITH WASHBASIN // AVEC VASQUE // CON LAVABO	WITH WASHBASIN // AVEC VASQUE // CON LAVABO
80	GLASS // VERRE // CRISTAL	GLASS // VERRE // CRISTAL	GLASS // VERRE // CRISTAL	GLASS // VERRE // CRISTAL	GLASS // VERRE // CRISTAL
100	CERAMIC CÉRAMIQUE PORCELANA (MODERN)	CERAMIC CÉRAMIQUE PORCELANA (MODERN)	CERAMIC CÉRAMIQUE PORCELANA (MODERN)	CERAMIC CÉRAMIQUE PORCELANA (MODERN)	CERAMIC CÉRAMIQUE PORCELANA (MODERN)
120**					
150**					

** 2 BOWLS // 2 CUVES // 2 PIAS

REVERSIBLE TALL CABINET WITH 1 DOOR
 COLONNE REVERSIBLE AVEC 1 PORTE
 COLUMNA REVERSIBLE CON 1 PUERTA

	WHITE // BLANC // BLANCO	CHERRY // CÉRISSE // CEREZO	G. WENGE // WENGE G. // WENGER G.	BELLIAN C. // BELLIAN C. BELLIAN	RAL COLOURS // COULEURS RAL // COLORES RAL
118					

MIRROR CABINET WITH 2 OR 3 DOORS
 ARMOIRES DE TOILETTE AVEC 2 OU 3 PORTES
 ARMARIOS CON ESPEJOS CON 2 OU 3 PUERTAS

	WHITE // BLANC // BLANCO	CHERRY // CÉRISSE // CEREZO	G. WENGE // WENGE G. // WENGER G.	BELLIAN C. // BELLIAN C. BELLIAN	RAL COLOURS // COULEURS RAL // COLORES RAL
60					
80					
100					
120					



150CM BASE UNIT WITH 4 DRAWERS - CHERRY | MODERN DUO CERAMIC COUNTERTOP WASHBASIN 151CM
 TALL CABINET WITH 1 DOOR - CHERRY | LESS MIRROR WITH LEDS 150CM | 2 UNITS NEXT - SINGLE LEVER BASIN MIXER
 MEUBLE 150CM AVEC 4 TIROIRS - CERISE | MODERN DUO PLAN VASQUE EN CÉRAMIQUE 151CM | COLONNE AVEC 1 PORTE - CERISE
 LESS MIROIR AVEC LEDS 150CM | 2 UNITÉS NEXT - MITIGEUR LAVABO
 MUEBLE 150CM CON 4 CAJONES - CEREZO | MODERN DUO LAVABO INTEGRAL DE PORCELANA 151 CM
 ARMARIO CON ESPEJOS 100 CM - CEREZO | 2 UNIDADES NEXT - LAVABO MONOMANDO | COLUMNNA CON 1 PUERTA - CEREZO

LESS // LESS LEDS

MIRROR // MIROIR // ESPEJO

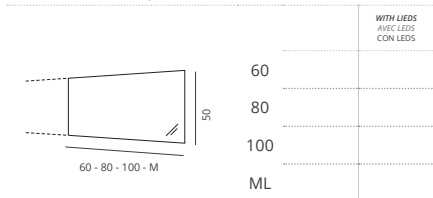

LISO

MIRROR WITH CHROMED FRAME
 MIROIR AVEC CADRE CHROMÉ
 ESPEJO CON MARCO CROMO

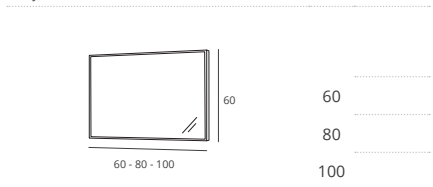

LINE // LINE II

LED LIGHT FIXTURE // APPLIQUE LED // APLIQUE LED

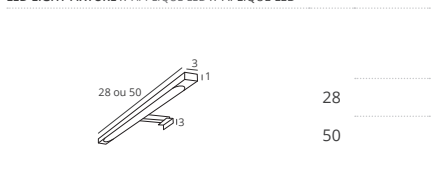







60CM BASE UNIT WITH 2 DRAWERS - GRAFITE WENGE | MODERN CERAMIC COUNTERTOP WASHBASIN 61CM | LISO MIRROR WITH CHROMED FRAME
 NIX - SINGLE LEVER BASIN MIXER | LINE II LED LIGHT FIXTURE
 MEUBLE 60CM AVEC 2 TIROIRS - WENGE GRAFITE | MODERN PLAN VASQUE EN CÉRAMIQUE 61CM | LISO MIROIR AVEC CADRE CHROMÉ
 NIX - MITIGEUR LAVABO | LINE II APPLIQUE LED
 MUEBLE 60CM CON 2 CAJONES - WENGER GRAFITO | MODERN LAVABO INTEGRAL DE PORCELANA 61 CM
 LISO - ESPEJO CON MARCO CROMO | NIX - LAVABO MONOMANDO | LINE II - APLIQUE LED

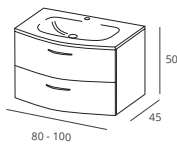

80CM BASE UNIT WITH 2 DRAWERS - WHITE | ESFERA CERAMIC COUNTERTOP WASHBASIN 81CM
 HARPA - SINGLE LEVER BASIN MIXER | DIVO MIRROR 80CM - WHITE | TUBE - HALOGEN LIGHT FIXTURE
 MEUBLE 80CM AVEC 2 TIROIRS - BLANC | ESFERA PLAN VASQUE EN CÉRAMIQUE 81CM
 HARPA - MITTIGEUR LAVABO | DIVO MIROIR 80CM - BLANC | TUBE - APPLIQUE HALOGÈNE
 MUEBLE 80CM CON 2 CAJONES - BLANCO | ESFERA LAVABO INTEGRAL DE PORCELANA 81 CM
 HARPA - LAVABO MONOMANDO | DIVO ESPEJO 80CM - BLANCO | TUBE - APLIQUE HALÓGENO

SUSPENDED BASE UNIT WITH 2 DRAWERS AND COUNTERTOP WASHBASIN
 MEUBLE SUSPENDU AVEC 2 TIROIRS ET LAVABO
 MUEBLE SUSPENDIDO CON 2 CAJONES Y LAVABO





			
	WHITE // BLANC // BLANCO WITH WASHBASIN ESFERA AVEC VASQUE ESFERA // CON LAVABO ESFERA	BELLIAN COLOURS // COULEURS BELLIAN // COLORES BELLIAN WITH WASHBASIN ESFERA AVEC VASQUE ESFERA // CON LAVABO ESFERA	RAL COLOURS // COULEURS RAL // COLORES RAL WITH WASHBASIN ESFERA AVEC VASQUE ESFERA // CON LAVABO ESFERA
	GLASS // VERRE // CRISTAL	GLASS // VERRE // CRISTAL	GLASS // VERRE // CRISTAL
			
	CERAMIC CÉRAMIQUE PORCELANA	CERAMIC CÉRAMIQUE PORCELANA	CERAMIC CÉRAMIQUE PORCELANA
80			
100			

DIVO

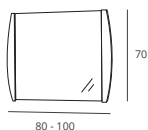
MIRROR // MIROIR // ESPEJO



			
	WHITE BLANC BLANCO	BELLIAN COLOURS COULEURS BELLIAN COLORES BELLIAN	RAL COLOURS COULEURS RAL COLORES RAL
80			
100			

TUBE

HALOGEN LIGHT FIXTURE // APPLIQUE HALOGÈNE // APLIQUE HALÓGENO

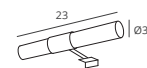

23



100CM BASE UNIT WITH 2 DRAWERS - SAPPHIRE | ESFERA CERAMIC COUNTERTOP WASHBASIN 101CM | SMART - SINGLE LEVER BASIN MIXER | DIVO MIRROR 100CM - WHITE | TUBE - HALOGEN LIGHT FIXTURE
 MEUBLE 100CM AVEC 2 TIROIRS - SAPHIR | ESFERA PLAN VASQUE EN CÉRAMIQUE 101CM | SMART - MITIGEUR LAVABO | DIVO MIROIR 100CM - BLANC | TUBE - APPLIQUE HALOGÈNE
 MUEBLE 100CM CON 2 CAJONES - ZAFIRO | ESFERA LAVABO INTEGRAL DE PORCELANA 101 CM | SMART - LAVABO MONOMANDO | DIVO ESPEJO 100CM - BLANCO | TUBE - APLIQUE HALÓGENO



CURVE SHAPES

Bellian® allows you to choose any color applied to the washbasin Esfera, thus enhancing the curved shapes of DIVO cabinet.

FORMES COURBES

Bellian® vous permet de choisir la couleur appliquée au lavabo Esfera, améliorant ainsi les formes courbes du meuble DIVO.

FORMAS CURVAS



Bellian® le permite elegir cualquier color aplicado a el lavabo Esfera, mejorando así las formas curvas del mueble DIVO.

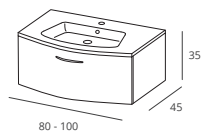

80CM BASE UNIT WITH 1 DRAWER - BLACK | ESFERA CERAMIC COUNTERTOP WASHBASIN 81CM | TYPE - SINGLE LEVER BASIN MIXER | ROUND MIRROR 80CM | ALTAIR - LED LIGHT FIXTURE
 MEUBLE 80CM AVEC 1 TIROIR - NOIR | ESFERA PLAN VASQUE EN CÉRAMIQUE 81CM | TYPE - MITIGEUR LAVABO | ROUND MIROIR 80CM - BLANC | ALTAIR - APPLIQUE LED
 MUEBLE 80CM CON 1 CAJÓN - NEGRO | ESFERA LAVABO INTEGRAL DE PORCELANA 81 CM | TYPE - LAVABO MONOMANDO | ROUND ESPEJO 80CM | ALTAIR - APLIQUE LED

SUSPENDED BASE UNIT WITH 1 DRAWER AND COUNTERTOP WASHBASIN
 MEUBLE SUSPENDU AVEC 1 TIROIR ET LAVABO
 MUEBLE SUSPENDIDO CON 1 CAJÓN Y LAVABO



WHITE // BLANC // BLANCO WITH WASHBASIN ESFERA AVEC VASQUE ESFERA // CON LAVABO ESFERA	BELLIAN COLOURS // COULEURS BELLIAN // COLORES BELLIAN WITH WASHBASIN ESFERA AVEC VASQUE ESFERA // CON LAVABO ESFERA	RAL COLOURS // COULEURS RAL // COLORES RAL WITH WASHBASIN ESFERA AVEC VASQUE ESFERA // CON LAVABO ESFERA
GLASS // VERRE // CRISTAL 	GLASS // VERRE // CRISTAL 	GLASS // VERRE // CRISTAL 
CERAMIC CÉRAMIQUE PORCELANA	CERAMIC CÉRAMIQUE PORCELANA	CERAMIC CÉRAMIQUE PORCELANA
80	80	80
100	100	100

ROUND

MIRROR WITH CHROMED FRAME
 MIROIR AVEC CADRE CHROMÉ
 ESPEJO CON MARCO CROMO

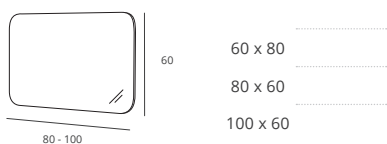

LISO

MIRROR WITH CHROMED FRAME
 MIROIR AVEC CADRE CHROMÉ
 ESPEJO CON MARCO CROMO

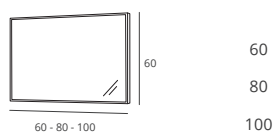

DIVO

MIRROR // MIROIR // ESPEJO

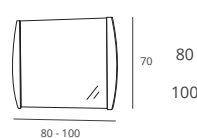

WHITE BLANC BLANCO	BELLIAN C C-BELLIAN C. BELLIAN	RAL COLOURS COULEURS RAL COLORES RAL
80	80	80
100	100	100



100CM BASE UNIT WITH 1 DRAWER - WHITE | ESFERA GLASS COUNTERTOP WASHBASIN 101CM - RED | TYPE - SINGLE LEVER BASIN MIXER | LISO MIRROR WITH CHROMED FRAME 100CM | VERO - HALOGEN LIGHT FIXTURE
 MEUBLE 100CM AVEC 1 TIROIR - BLANC | ESFERA PLAN VASQUE EN VERRE 101CM - ROUGE | TYPE - MITIGEUR LAVABO | LISO MIROIR AVEC CADRE 100CM | VERO - APPLIQUE HALOGÈNE
 MUEBLE 100CM CON 1 CAJÓN - BLANCO | ESFERA LAVABO DE CRISTAL DE ENCIMERA 101 CM - ROJO | TYPE - LAVABO MONOMANDO | LISO ESPEJO CON MARCO CROMO 100CM | VERO - APLIQUE HALÓGENO

ALTAIR

LED LIGHT FIXTURE // APPLIQUE LED // APLIQUE LED

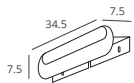

35

VERO

HALOGEN LIGHT FIXTURE
 APPLIQUE HALOGÈNE // APLIQUE HALÓGENO



25.5

CHROME
 CHROME
 CROMO

MATTE
 MATE
 MATE

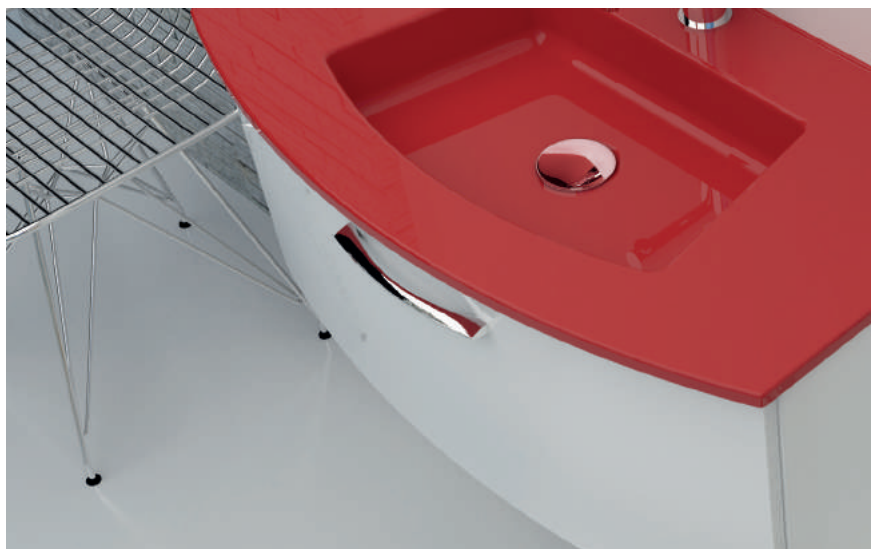



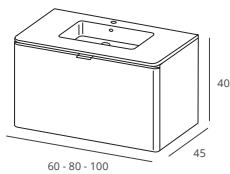

80CM BASE UNIT WITH 1 DRAWER - BLACK | FLUX CERAMIC COUNTERTOP WASHBASIN 81CM | KNOBE - SINGLE LEVER BASIN MIXER | ROUND MIRROR 70CM | ALTAIR - LED LIGHT FIXTURE
 MEUBLE 80CM AVEC 1 TIROIR - NOIR | FLUX PLAN VASQUE EN CÉRAMIQUE 81CM | KNOBE - MITIGEUR LAVABO | ROUND MIROIR 70CM | ALTAIR - APPLIQUE LED
 MUEBLE 80CM CON 1 CAJÓN - NEGRO | FLUX LAVABO INTEGRAL DE PORCELANA 81 CM | KNOBE - LAVABO MONOMANDO | ROUND ESPEJO 70CM | ALTAIR - APLIQUE LED

SUSPENDED BASE UNIT WITH 1 DRAWER AND COUNTERTOP WASHBASIN
 MEUBLE SUSPENDU AVEC 1 TIROIR ET LAVABO
 MUEBLE SUSPENDIDO CON 1 CAJÓN Y LAVABO



WHITE // BLANC // BLANCO WITH WASHBASIN FLUX AVEC VASQUE FLUX // CON LAVABO FLUX	BELLIAN COLOURS // COULEURS BELLIAN // COLORES BELLIAN WITH WASHBASIN FLUX AVEC VASQUE FLUX // CON LAVABO FLUX	RAL COLOURS // COULEURS RAL // COLORES RAL WITH WASHBASIN FLUX AVEC VASQUE FLUX // CON LAVABO FLUX
GLASS // VERRE // CRISTAL 	GLASS // VERRE // CRISTAL 	GLASS // VERRE // CRISTAL 
CERAMIC CÉRAMIQUE PORCELANA	CERAMIC CÉRAMIQUE PORCELANA	CERAMIC CÉRAMIQUE PORCELANA
60		
80		
100		

ROUND

MIRROR // MIROIR // ESPEJO

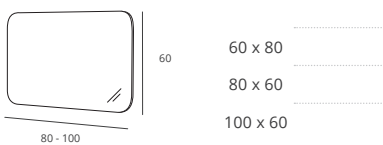

NORDIC

MIRROR CABINETS // ARMOIRES DE TOILETTE // ARMARIOS CON ESPEJOS

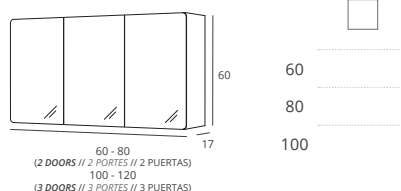

ALTAIR

LED LIGHT FIXTURE // APPLIQUE LED // APLIQUE LED

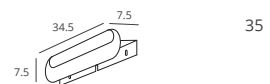



**MULTI FITTING SUPPORT
SUPPORT MULTI-FIXATION
APOYO MULTI-FIJACIÓN**

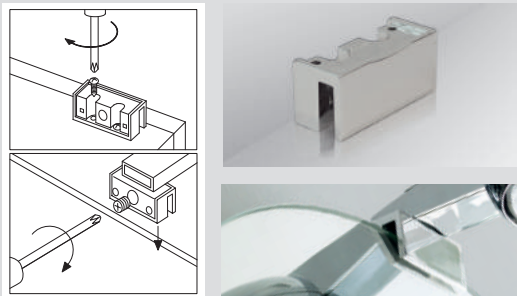

60CM BASE UNIT WITH 1 DRAWER - WHITE | FLUX CERAMIC COUNTERTOP WASHBASIN 61CM | KNOBE - SINGLE LEVER BASIN MIXER | MIRROR CABINET 60CM | TUBE - HALOGEN LIGHT FIXTURE WITH MULTI SUPORT MOUNT ACCESSORY
MEUBLE 80CM AVEC 1 TIROIR - BLANC | FLUX PLAN VASQUE EN CÉRAMIQUE 61CM | KNOBE - MITIGEUR LAVABO | ARMOIRE DE TOILETTE 60CM
TUBE - APPLIQUE HALOGÈNE AVEC ACCESSOIRE MULTI SUPPORT MOUNT
MUEBLE 60CM CON 1 CAJÓN - BLANCO | FLUX LAVABO INTEGRAL DE PORCELANA 61 CM | KNOBE - LAVABO MONOMANDO ARMARIO CON ESPEJO 60CM | TUBE - APLIQUE HALÓGENO CON ACCESORIO MULTI SUPPORT MOUNT

FLUX

THE SAME BASIN MODEL: 2 DIFFERENT FINISHES

We present the FLUX washbasin, a unique model with 2 finish options. Choose your in ceramic white or Bellian® glass or RAL color. FLUX is compatible with the range of of furniture ALFA and ROUND.

LE MÊME MODÈLE DE VASQUE: 2 FINITIONS DIFFÉRENTES

Nous présentons le lavabo FLUX, un modèle unique avec 2 options de finition. Choisissez votre en céramique blanc ou verre Bellian® ou encore couleur RAL. FLUX est compatible avec la gamme des meubles ALFA et ROUND.

EL MISMO MODELO DE LAVABO: 2 ACABADOS DIFERENTES

Presentamos el lavabo FLUX, un modelo único con 2 opciones de acabado. Elija su en cerámica blanca o de vidrio Bellian® o color RAL. FLUX es compatible con la gamas de muebles ALFA y ROUND.











80CM BASE UNIT WITH 2 DRAWERS - WHITE AND SAPPHIRE | FLUX CERAMIC COUNTERTOP WASHBASIN 81CM
 SMART - SINGLE LEVER BASIN MIXER | ROUND MIRROR 70CM | ALTAIR - LED LIGHT FIXTURE
 MEUBLE 80CM AVEC 2 TIROIRS - BLANC AND SAPHIR | FLUX PLAN VASQUE EN CÉRAMIQUE 81CM | SMART - MITIGEUR LAVABO
 ROUND MIROIR 70CM | ALTAIR - APPLIQUE LED
 MUEBLE 80CM CON 2 CAJONES - BLANCO Y ZAFIRO | FLUX LAVABO INTEGRAL DE PORCELANA 81 CM
 SMART - LAVABO MONOMANDO | ROUND ESPEJO 70CM | ALTAIR - APLIQUE LED



SUSPENDED BASE UNIT WITH 2 DRAWERS AND COUNTERTOP WASHBASIN
 MEUBLE SUSPENDU AVEC 2 TIROIRS ET LAVABO
 MUEBLE SUSPENDIDO CON 2 CAJONES Y LAVABO

			
	WHITE // BLANC // BLANCO	WHITE + BELLIAN COLOURS BLANC + COULEURS BELLIAN // BLANCO + COLORES BELLIAN	RAL COLOURS // COULEURS RAL // COLORES RAL
	WITH WASHBASIN FLUX AVEC VASQUE FLUX // CON LAVABO FLUX	WITH WASHBASIN FLUX AVEC VASQUE FLUX // CON LAVABO FLUX	WITH WASHBASIN FLUX AVEC VASQUE FLUX // CON LAVABO FLUX
	GLASS // VERRE // CRISTAL	GLASS // VERRE // CRISTAL	GLASS // VERRE // CRISTAL
			
60			
80			
100			

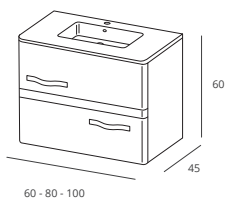

LIGHT H

WHITE MIRROR WITH FLUORESCENT LIGHTING
 MIROIR BLANC AVEC ÉCLAIRAGE FLUORESCENT
 ESPEJO BLANCO CON ILUMINACION FLUORESCENTE

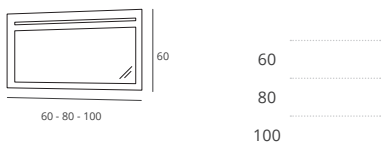

ROUND

MIRROR // MIROIR // ESPEJO

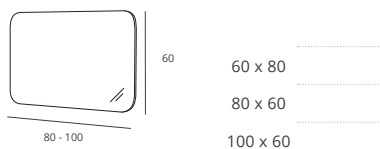

ALTAIR

LED LIGHT FIXTURE // APPLIQUE LED // APLIQUE LED





80CM BASE UNIT WITH 2 DRAWERS - WHITE AND EGGPLANT | FLUX GLASS COUNTERTOP WASHBASIN 81CM - EGGPLANT
 SMART - SINGLE LEVER BASIN MIXER | LIGHT H WHITE - MIRROR WITH FLUORESCENT LIGHTING 80CM
 MEUBLE 80CM AVEC 2 TIROIRS - BLANC ET AUBERGINE | FLUX PLAN VASQUE EN VERRE 81CM
 SMART - MITTIGEUR LAVABO | LIGHT H BLANC - MIROIR AVEC ÉCLAIRAGE FLUORESCENT 80CM
 MUEBLE 80CM CON 2 CAJÓNES - BLANCO Y BERENJENA | FLUX LAVABO DE CRISTAL DE ENCIMERA 81 CM
 SMART - LAVABO MONOMANDO | LIGHT H BLANCO - ESPEJO CON ILUMINACIÓN FLUORESCENTE 80CM



FLUX

WHITE CERAMIC COLOUR GLASS

Countertop washbasin with rounded corners, available in white ceramic or Bellian® color glass or RAL. FLUX is compatible with the range of furniture ALFA and ROUND. See page 162.

CERAMIQUE BLANC VERRE COLORÉ

Plan vasque des coins arrondis disponible en céramique blanc ou en verre de couleur Bellian® ou RAL. FLUX est compatible avec la gamme des meubles ALFA et ROUND. Voir page 162.

CERÁMICA BLANCA CRISTAL DE COLOR

Lavabo integral de esquinas redondeadas disponible en cerámica blanca o vidrio de color Bellian® o RAL. Flux es compatible con la gama de muebles ALFA y ROUND. Vea la página 162.

MODULAR COMPOSITIONS

TEEN is a fun collection of bathroom furniture for young and dynamic spaces. With only 35 cm deep TEEN cabinets are available with 1 or 2 drawers, suspended application option or to the ground. The reversible shelves of this collection allows vertical or horizontal application, giving you unparalleled freedom to furnish your bathroom to your needs.

COMPOSITIONS MODULAIRES

TEEN est une amusante collection de meubles de salle de bains pensée pour les espaces jeunes et pleines de dynamisme.

Avec seulement 35 cm de profondeur, les meubles TEEN sont disponibles avec 1 ou 2 tiroirs, suspendu ou au sol.

La réversibilité des étagères de cette collection permet une application verticale ou horizontale, vous donnant une liberté inégalée pour meubler votre salle de bains à la mesure de vos besoins.

COMPOSICIONES MODULARES

TEEN es una divertida colección de muebles de baño para espacios pequeños y dinámicos. Las estantes reversibles de esta colección permiten la aplicación tanto vertical como horizontalmente, que le da una libertad sin precedentes para amueblar su cuarto de baño según sus necesidades.

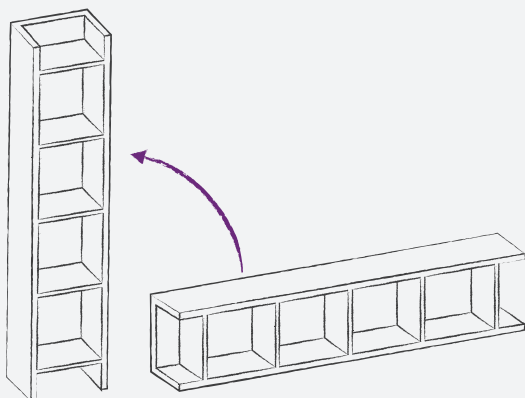

TEEN HANDLES

TEEN handles are available in white for all colours furniture and in anthracite for white furniture.



POIGNÉES TEEN

Les poignées de la gamme TEEN sont disponibles en blanc pour toutes les couleurs des meubles et en anthracite pour les meubles blancs.

TIRADORES TEEN

Los tiradores de la gama TEEN están disponibles en blanco para todos los colores de muebles y antracite para los muebles blancos.



Ten

bellian

MINI 35
REDUCED DEPTH
PROFONDEUR RÉDUITE
PROFUNDIDAD REDUCIDA

let's
play

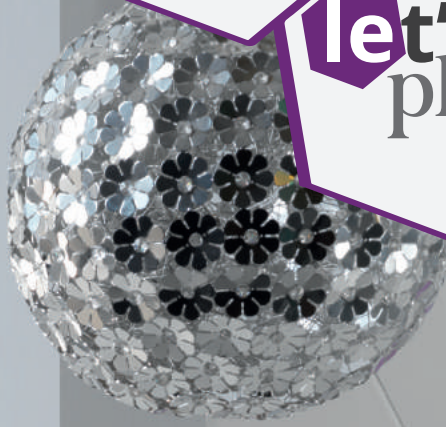

80CM BASE UNIT WITH 2 DRAWERS - EGGPLANT | 4 FEET FOR BASE UNIT | ZIP CERAMIC COUNTERTOP WASHBASIN 81CM
KNOBE - SINGLE LEVER BASIN MIXER | LIGHT H WHITE - MIRROR WITH FLUORESCENT LIGHTING 80CM
MEUBLE 80CM AVEC 2 TIROIRS - AUBERGINE | ZIP PLAN VASQUE EN CÉRAMIQUE 81CM
KNOBE - MITIGEUR LAVABO | LIGHT H BLANC - MIROIR AVEC ÉCLAIRAGE FLUORESCENT 80CM
MUEBLE 80CM CON 2 CAJONES - BERENJENA | ZIP LAVABO INTEGRAL DE PORCELANA 81 CM
KNOBE - LAVABO MONOMANDO | LIGHT H BLANCO - ESPEJO CON ILUMINACIÓN FLUORESCENTE 80CM



FOR YOUNG AND DYNAMIC SPACES
POUR LES ESPACES JEUNES ET DYNAMIQUES
PARA ESPACIOS JOVENES Y DINÁMICOS

Ten

FOR YOUNG AND DYNAMIC SPACES
POUR LES ESPACES JEUNES ET DYNAMIQUES
PARA ESPACIOS JOVENES Y DINÁMICOS

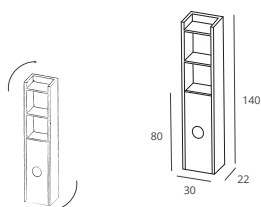

TALL CABINET WITH 1 DOOR + 3 SHELVES
COLLONE AVEC 1 PORTE + 3 ÉTAGÈRES
COLUMNA CON 1 PUERTA + 3 REPISAS



		
WHITE BLANC BLANCO	BELLIAN COLOURS COULEURS BELLIAN COLORES BELLIAN	RAL COLOURS COULEURS RAL COLORES RAL

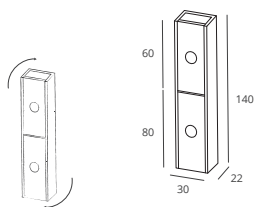

REVERSIBLE TALL CABINET WITH 2 DOORS
COLLONE REVERSIBLE AVEC 2 PORTES
COLUMNA REVERSIBLE CON 2 PUERTAS



		
WHITE BLANC BLANCO	BELLIAN COLOURS COULEURS BELLIAN COLORES BELLIAN	RAL COLOURS COULEURS RAL COLORES RAL

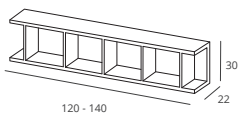

REVERSIBLE SHELF
ÉTAGÈRE REVERSIBLE
ESTANTE REVERSIBLE



		
WHITE BLANC BLANCO	BELLIAN COLOURS COULEURS BELLIAN COLORES BELLIAN	RAL COLOURS COULEURS RAL COLORES RAL

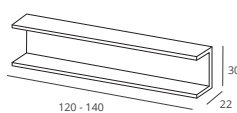

SHELF
ÉTAGÈRE
ESTANTE

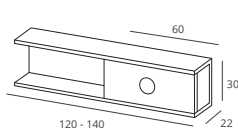
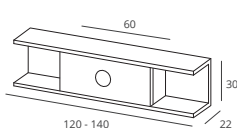
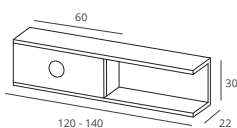

		
WHITE BLANC BLANCO	BELLIAN COLOURS COULEURS BELLIAN COLORES BELLIAN	RAL COLOURS COULEURS RAL COLORES RAL

SHELF WITH 1 DOOR
ÉTAGÈRE AVEC 1 PORTE
ESTANTE CON 1 PUERTA



		
WHITE BLANC BLANCO	BELLIAN COLOURS COULEURS BELLIAN COLORES BELLIAN	RAL COLOURS COULEURS RAL COLORES RAL



MINI 35
 REDUCED DEPTH
 PROFONDEUR RÉDUITE
 PROFUNDIDAD REDUCIDA

let's play
K



2 UNITS 60CM BASE UNIT WITH 1 DRAWER - RED | 2 UNITS ZIP CERAMIC COUNTERTOP WASHBASIN 60CM | 2 UNITS SMOOTH - SINGLE LEVER BASIN MIXER | REVERSIBLE TALL CABINET WITH 2 DOORS - RED AND PINE GREEN
 REVERSIBLE TALL CABINET WITH 1 DOOR AND 3 SELVES - RED AND PINE GREEN | SHELF 140CM - PINE GREEN | LESS MIRROR 140CM | 2 UNITS SUN LED LIGHT FIXTURE WITH MULTY SUPPORT MOUNT ACCESSORY
 2 UNITÉS MEUBLE 60CM AVEC 1 TIROIR - ROUGE | 2 UNITÉS ZIP PLAN VASQUE EN CÉRAMIQUE 60CM | 2 UNITÉS SMOOTH - MITIGEUR LAVABO | COLLONE REVERSIBLE AVEC 2 PORTES - ROUGE ET VERT PINE | COLLONE REVERSIBLE AVEC 1 PORTE ET 3 ÉTAGÈRES - ROUGE ET VERT PINE | ÉTAGÈRE 140CM - VERT PINE | LESS MIROIR 140CM | 2 UNITÉS SUN APPLIQUE LED AVEC ACCESSOIRE MULTI SUPPORT MOUNT
 2 UNIDADES MUEBLE 60CM CON 1 CAJÓN - ROJO | 2 UNIDADES ZIP LAVABO INTEGRAL DE PORCELANA 60 CM | 2 UNIDADES SMOOTH - LAVABO MONOMANDO | COLUMNA REVERSIBLE CON 2 PUERTAS - ROJO Y VERDE PINO
 COLUMNA REVERSIBLE CON 1 PUERTA Y 3 REPISAS | ESTANTE 140CM - VERDE PINO | LESS ESPEJO 140CM | 2 UNIDADES SUN APLIQUE LED CON ACCESORIO MULTI SUPPORT MOUNT

BASE UNIT W/ 2 DRAWERS AND ZIP COUNTERTOP WASHBASIN
 MEUBLE AVEC 2 TIROIRS ET LAVABO ZIP
 MUEBLE CON 2 CAJONES Y LAVABO ZIP

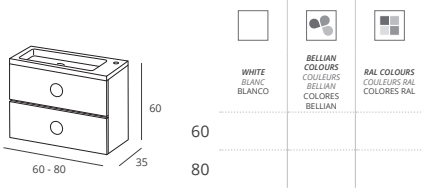

SUSPENDED BASE UNIT W/ 1 DRAWER AND ZIP COUNTERTOP W.
 MEUBLE SUSPENDU AVEC 1 TIROIR ET LAVABO ZIP
 MUEBLE SUSPENDIDO CON 1 CAJÓN Y LAVABO ZIP

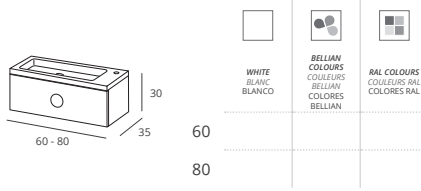

BASE UNIT FOOT (UNIT)
 PIED POUR MEUBLE (UNITÉ)
 PIE DE MUEBLE (UNIDAD)



LESS // LESS LEDS
 MIRROR // MIROIR // ESPEJO

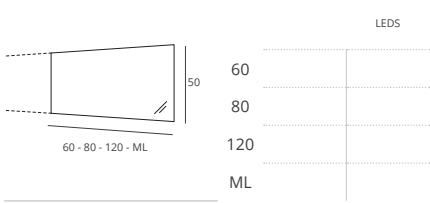

LIGHT H WHITE
 WHITE MIRROR WITH FLUORESCENT LIGHTING
 MIROIR BLANC AVEC ÉCLAIRAGE FLUORESCENT
 ESPEJO BLANCO CON ILUMINACION FLUORESCENTE

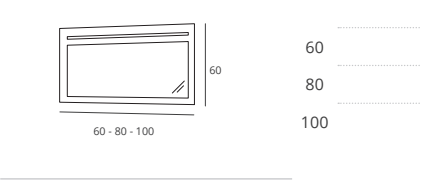

SUN
 LED LIGHT FIXTURE // APPLIQUE LED // APLIQUE LED

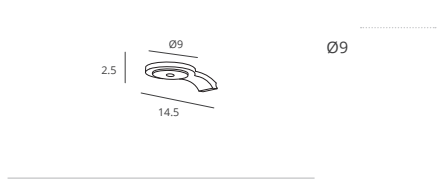



50 CM BASE UNIT WITH 1 DRAWER - TAIGA WOOD | SHORT CERAMIC COUNTERTOP WASHBASIN 51CM | SMART - SINGLE LEVER BASIN MIXER | SIMPLE MIRROR 50 CM | VERO HALOGEN LIGHT FIXTURE
 MEUBLE 50CM AVEC 1 TIROIR - BOIS TAIGA | SHORT VASQUE EN CÉRAMIQUE 51 CM | SMART - MITIGEUR LAVABO | MIROIR SIMPLE 50 CM | VERO APPLIQUE HALOGÈNE
 MUEBLE 50CM CON 1 CAJÓN - MADERA TAIGA | SHORT LAVABO INTEGRAL DE PORCELANA 51 CM | SMART - LAVABO MONOMANDO | SIMPLES ESPEJO 50 CM | VERO APLIQUE HALÓGENO

SUSPENDED BASE UNIT W/ 1 DRAWER AND SHORT COUNTERTOP WASHBASIN
 MEUBLE SUSPENDU AVEC 1 TIROIR ET LAVABO SHORT
 MUEBLE SUSPENDIDO CON 1 CAJÓN Y LAVABO SHORT

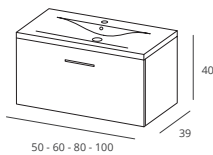

	WHITE BLANC	ESTEPA W. M. ESTEPA	TAIGA W. M. TAIGA	CHERRY W. M. CEREJO	G. WENGE WENGER G.	BELLIAN COLOURS COLORES BELLIAN	RAL COLOURS COLORES RAL
50							
60							
80							
100							

LEO
 LED LIGHT FIXTURE // APPLIQUE LED // APLIQUE LED



30

SIMPLES
 MIRROR // MIROIR // ESPEJO

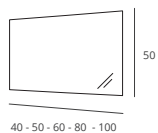

40
50
60
80
100

LISO
 MIRROR WITH CHROMED FRAME
 MIROIR AVEC CADRE CHROMÉ
 ESPEJO CON MARCO CROMO

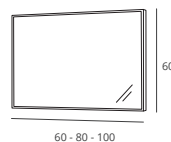

60
80
100

VERO
 HALOGEN LIGHT FIXTURE // APPLIQUE HALOGÈNE // APLIQUE HALÓGENO

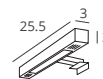

CHROME
CROMO

MATTE
MATE

25.5



100 CM BASE UNIT WITH 1 DRAWER - ANTHRACITE | SHORT CERAMIC COUNTERTOP WASHBASIN 101CM
 PIXEL - SINGLE PIXEL LEVER BASIN MIXER | LISO MIRROR WHIT CHROMED FRAME 50 CM | LEO LED LIGHT FIXTURE
 MEUBLE 100 CM AVEC 1 TIROIR - ANTHRACITE | SHORT VASQUE EN CÉRAMIQUE 101 CM | PIXEL - MITIGEUR LAVABO
 LISO MIROIR AVEC CADRE CHROMÉ 50 CM | LEP APPLIQUE LED
 MUEBLE 100 CM CON 1 CAJÓN - ANTRACITE | SHORT LAVABO INTEGRAL DE PORCELANA 101 CM
 PIXEL LAVABO MONOMANDO | LISO - ESPEJO CON MARCO CROMO 50 CM | VERO APLIQUE HALÓGENO

MIRROR CABINETS

SEE THE FULL RANGE ON PAGE 152

ARMOIRES AVEC MIROIR

VOIR LA GAMME COMPLÈTE SUR LA PAGE 152

ARMARIOS CON ESPEJO

VER LA GAMA COMPLETA EN LA PÁGINA 152

NORDIC

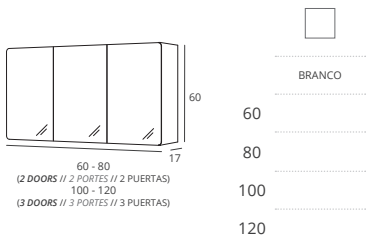

120 CM BASE UNIT WITH 2 DRAWERS - WHITE AND BORDEAUX | GLASS COUNTERTOP WASHBASIN DUO 121CM- BORDEAUX
2 UNITS HARPA - SINGLE LEVER BASIN MIXER | MIRROR CABINET 120 CM - WHITE | 2 UNITS LYRA LED LIGHT FIXTURE
MEUBLE 120 CM AVEC 2 TIROIRS - BLANC ET BORDEAUX | VASQUE DUO EN VERRE 121 CM - BORDEAUX
2 UNITÉS HARPA - MITIGEUR LAVABO | ARMOIRE DE TOILETTE 120 CM - BLANC | 2 UNITÉS LYRA APPLIQUE LED
MUEBLE 120 CM CON 2 CAJONES - BLANCO Y BORDEAUX | LAVABO DUO DE CRISTAL DE ENCIMERA 51 CM - BORDEAUX
2 UNIDADES HARPA - LAVABO MONOMANDO | ARMARIO CON ESPEJOS 120 CM - BLANCO | 2 UNIDADES LYRA - APLIQUE HALÓGENO

SUSPENDED BASE UNIT W/ 2 DRAWERS AND COUNTERTOP WASHBASIN
MEUBLE SUSPENDU AVEC 2 TIROIRS ET LAVABO
MUEBLE SUSPENDIDO CON 2 CAJONES Y LAVABO

THERMOLAMINATES // TERMOLAMINÉS // TERMOLAMINADOS

	WHITE // BLANC // BLANCO	THERMO. BELLIAN C. // TERMO. C. BELLIAN // TERMO. C. BELLIAN	BRANCO + CORES
	WITH WASHBASIN // AVEC VASQUE // CON LAVABO	WITH WASHBASIN // AVEC VASQUE // CON LAVABO	WITH WASHBASIN // AVEC VASQUE // CON LAVABO
	GLASS // VERRE // CRISTAL	GLASS // VERRE // CRISTAL	GLASS // VERRE // CRISTAL
	CERAMIC CERAMIQUE PORCELANA (MODERN)	CERAMIC CERAMIQUE PORCELANA (MODERN)	CERAMIC CERAMIQUE PORCELANA (MODERN)
60			
80			
100			
120*			
120**			

* 1 BOWL // 2 CUVE // 2 PIA ** 2 BOWLS // 2 CUVES // 2 PIAS

SPOT

REVERSIBLE MIRROR // MIROIR REVERSIBLE // ESPEJO REVERSIBLE

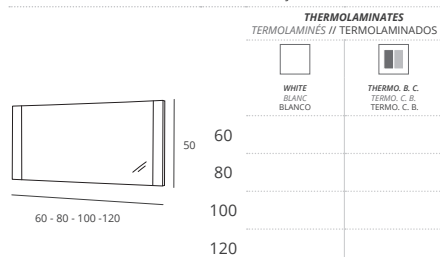

LYRA // LYRA II

LED LIGHT FIXTURE // APPLIQUE LED // APLIQUE LED

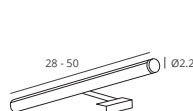

28
50

CUBE M

HALOGEN LIGHT FIXTURE // APPLIQUE HALOGÈNE // APLIQUE HALÓGENO



10

CHROME
CHROMÉ
CROMO



1 Handle RINCOMATIC aluminum gloss finished

Poignée en aluminium RINCOMATIC fini brillant

Tirador de aluminio RINCOMATIC con acabado brillo



2 Bicolor edge in drawers and chromed on cabinet structure

Bord bicolor dans les tiroirs et chromé dans la structure du meuble

Borde bicolor en los cajones y cromo en la estructura del mueble



80 CM BASE UNIT WITH 2 DRAWERS - BLACK | GLASS COUNTERTOP WASHBASIN 81 CM - BLACK | PIXEL - SINGLE LEVER BASIN MIXER | SPOT MIRROR 80 CM - BLACK | 2 UNITS CUBE M HALOGEN LIGHT FIXTURE
 MEUBLE 80 CM AVEC 2 TIROIRS - NOIR | PLAN VASQUE EN VERRE 81 CM - NOIR | PIXEL - MITIGEUR LAVABO | SPOT MIROIR 80 CM - NOIR | 2 UNITÉS CUBE M APPLIQUE HALOGEN
 MUEBLE 80 CM CON 2 CAJONES - NEGRO | LAVABO DE CRISTAL DE ENCIMERA 81 CM - NEGRO | PIXEL - LAVABO MONOMANDO | SPOT ESPEJO 80 CM - NEGRO | 2 UNIDADES CUBE M - APLIQUE HALOGENO



120 CM BASE UNIT WITH 2 DRAWERS - WHITE | MODERN - CERAMIC COUNTERTOP WASHBASIN 121 CM | HARPA - SINGLE LEVER BASIN MIXER
 SPOT MIRROR 120 CM - WHITE | 2 UNITS CUBE M HALOGEN LIGHT FIXTURE
 MEUBLE 120 CM AVEC 2 TIROIRS - BLANC | MODERN PLAN VASQUE EN CÉRAMIQUE 121 CM | HARPA - MITIGEUR LAVABO
 SPOT MIROIR 120 CM - BLANC | 2 UNITÉS CUBE M APPLIQUE HALOGEN
 MUEBLE 120 CM CON 2 CAJONES - BLANCO | LAVABO INTEGRAL DE PORCELANA 121 CM | HARPA - LAVABO MONOMANDO
 SPOT ESPEJO 1200 CM - BLANCO | 2 UNIDADES CUBE M - APLIQUE HALOGENO

TERMOLAMINATE BELLIAN COLORS

Spot cabinet stands out for its thermolaminate finish, which gives it a unique brightness while ensuring high strength and hygiene that your bathroom space requires.

TERMOLAMINÉ COULEURS BELLIAN

Le meuble Spot se distingue par son finition laminé, ce qui lui confère une luminosité unique, tout en assurant une haute résistance et l'hygiène que votre espace de salle de bain a besoin.

TERMOLAMINADOS COLORES BELLIAN

El mueble Spot se destaca por su acabado laminado, que le da un brillo único asegurando una alta resistencia y la higiene que su espacio de baño requiere.

TERMOLAMINATE // TERMOLAMINÉ // TERMOLAMINADOS

WHITE BLANC	BLACK NOIR NEGRO	ANTHRACITE ANTHRACITE ANTRACITE	BORDEAUX BORDEAUX BORDEAUX
EGGPLANT AUBERGINE BERENJENA	RED ROUGE ROJO	BEIGE BEIGE BEIGE	



100 CM BASE UNIT WITH 1 DRAWER - ANTHRACITE TEXTURE | MODERN - CERAMIC COUNTERTOP WASHBASIN 100CM | NEXT - SINGLE LEVER BASIN MIXER
 TALL CABINET WITH 2 DOORS - ANTHRACITE TEXTURE | TWICE MIRROR 100 CM - ANTHRACITE TEXTURE | LINE II LED LIGHT FIXTURE
 MEUBLE 100 CM AVEC 1 TIROIR - TEXTURE ANTHRACITE | MODERN - VASQUE EN CÉRAMIQUE 101 CM | NEXT - MITIGEUR LAVABO | COLLONE AVEC 2 PORTES - TEXTURE ANTHRACITE
 TWICE MIROIR 100 CM - TEXTURE ANTHRACITE | LINE II APPLIQUE LED
 MUEBLE 100 CM CON 1 CAJÓN - TEXTURA ANTRACITE | MODERN LAVABO INTEGRAL DE PORCELANA 101 CM | NEXT - LAVABO MONOMANDO
 COLUMNA CON 2 PUERTAS - TEXTURA ANTRACITE | TWICE ESPEJO 100CM - TEXTURA ANTRACITE | LINE II - APLIQUE CON LEDS

SUSPENDED BASE UNIT W/ 2 DRAWERS AND COUNTERTOP WASHBASIN
 MEUBLE SUSPENDU AVEC 2 TIROIRS ET LAVABO
 MUEBLE SUSPENDIDO CON 2 CAJONES Y LAVABO

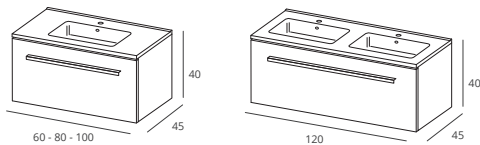

THERMOLAMINATES TERMOLAMINÉS // TERMOLAMINADOS			
ANTHRACITE ANTHRACITE ANTRACITE	BEIGE BEIGE BEIGE	TEXTURE + ANTHRACITE TEXTURE + ANTHRACITE TEXTURA + ANTRACITE	TEXTURE + BEIGE TEXTURE + BEIGE TEXTURA + BEIGE
WITH WASHBASIN // AVEC VASQUE // CON LAVABO			
GLASS // VERRE // CRISTAL		CERAMIC CÉRAMIQUE PORCELANA (MODERN)	
60			
80			
100			
120**			

LINE // LINE II
 LED LIGHT FIXTURE // APPLIQUE LED // APLIQUE LED

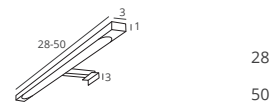

28
50

LEO
 LED LIGHT FIXTURE // APPLIQUE LED // APLIQUE LED



30

** 2 BOWLS // 2 CUVES // 2 PIAS

TWICE
 MIRROR // MIROIR // ESPEJO

THERMOLAMINATES // TERMOLAMINÉS // TERMOLAMINADOS			
ANTHRACITE ANTHRACITE ANTRACITE	BEIGE BEIGE BEIGE	TEXTURE + ANTHRACITE TEXTURE + ANTHRACITE TEXTURA + ANTRACITE	TEXTURE + BEIGE TEXTURE + BEIGE TEXTURA + BEIGE
60			
80			
100			
120			

TALL CABINET WITH 2 DOORS
 COLLONE AVEC 2 PORTES
 COLUMNA CON 2 PUERTAS

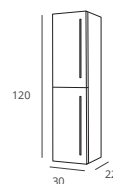

THERMOLAMINATES // TERMOLAMINÉS // TERMOLAMINADOS			
ANTHRACITE ANTHRACITE ANTRACITE	BEIGE BEIGE BEIGE	TEXTURE + ANTHRACITE TEXTURE + ANTHRACITE TEXTURA + ANTRACITE	TEXTURE + BEIGE TEXTURE + BEIGE TEXTURA + BEIGE
30			



60 CM BASE UNIT WITH 1 DRAWER - BEIGE TEXTURE | MODERN - CERAMIC COUNTERTOP WASHBASIN 100CM | SMART - SINGLE LEVER BASIN MIXER
 TALL CABINET WITH 2 DOORS - BEIGE TEXTURE | TWICE MIRROR 60 CM - BEIGE TEXTURE | LINE II LED LIGHT FIXTURE
 MEUBLE 60 CM AVEC 1 TIROIR - TEXTURE BEIGE | MODERN - VASQUE EN CÉRAMIQUE 61 CM | SMART - MITTGEUR LAVABO
 COLLENE AVEC 2 PORTES - TEXTURE BEIGE | TWICE MIROIR 60 CM - TEXTURE BEIGE | LINE II APPLIQUE LED
 MUEBLE 60 CM CON 1 CAJÓN - TEXTURA BEIGE | MODERN LAVABO INTEGRAL DE PORCELANA 101 CM | NEXT - LAVABO MONOMANDO
 COLUMNA CON 2 PUERTAS - TEXTURA BEIGE | TWICE ESPEJO 100CM - TEXTURA BEIGE | LINE II - APLIQUE CON LEDS



LATERALS WITH THERMOLAMINATE TEXTURE

The Twice furniture stands out for the originality of its thermolaminated finishes, that from its side assumes a proper identity that personalizes your bathroom space.

LATÉRALES AVEC TEXTURE TERMOLAMINÉ

Le meuble Twice se distingue par l'originalité de ses finitions termolaminées, que dans le côté prend une identité unique qui personnalise votre salle de bains.

LATERALES CON TEXTURA TERMOLAMINADA





El mobiliario Twice se destaca por la originalidad de sus acabados termolaminados, que en los lados asume una identidad propia que personaliza su espacio de baño.



80 CM BASE UNIT WITH 1 DRAWER - WHITE AND ANTHRACITE | SHORT - CERAMIC COUNTERTOP WASHBASIN 81CM | KEEN - SINGLE LEVER BASIN MIXER | DELTA MIRROR 70 CM
 MEUBLE 80 CM AVEC 1 TIROIR - BLANC ET ANTHRACITE | SHORT - VASQUE EN CÉRAMIQUE 81 CM | KEEN - MITIGEUR LAVABO | DELTA MIROIR 70 CM - BLANC ET ANTHRACITE
 MUEBLE 80 CM CON 1 CAJÓN - BLANCO Y ANTRACITE | SHORT LAVABO INTEGRAL DE PORCELANA 81 CM | KEEN - LAVABO MONOMANDO | DELTA ESPEJO 70CM

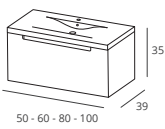



SUSPENDED BASE UNIT W/ 1 DRAWER AND SHORT COUNTERTOP WASHBASIN

MEUBLE SUSPENDU AVEC 1 TIROIR ET SHORT LAVABO
 MUEBLE SUSPENDIDO CON 1 CAJÓN Y SHORT LAVABO

 <p>50 - 60 - 80 - 100</p>	 WHITE BLANC BLANCO	 WHITE + BELLIAN C. BLANC + C. BELLIAN BLANCO + C. BELLIAN	 BELLIAN COLOURS COULEURS BELLIAN COLORES BELLIAN	 RAL COLOURS COULEURS RAL COLORES RAL
	50			
	60			
	80			
	100			

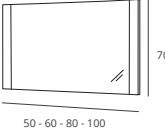
LISTA

MIRROR // MIROIR // ESPEJO

 <p>50 - 60 - 80 - 100</p>	 WHITE BLANC BLANCO	 BELLIAN COLOURS COULEURS BELLIAN COLORES BELLIAN	 RAL COLOURS COULEURS RAL COLORES RAL
	50		
	60		
	80		
	100		

DELTA

LED LIGHT FIXTURE // APPLIQUE LED // APLIQUE LED

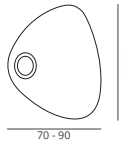
 <p>70 - 90</p>	70
	90

VERO

HALOGEN LIGHT FIXTURE // APPLIQUE HALOGÈNE // APLIQUE HALÓGENO

 <p>25.5 3 13</p>	CHROME CHROME CROMO	MATTE MATE MATE
	25.5	

LEO

LED LIGHT FIXTURE // APPLIQUE LED // APLIQUE LED

 <p>30 3 13</p>	30

CRISP



60 CM BASE UNIT WITH 1 DRAWER - WHITE AND SAPPHIRE | SHORT - CERAMIC COUNTERTOP WASHBASIN 61 CM | KEEN - SINGLE LEVER BASIN MIXER | LISTA MIRROR 60 CM - SAPPHIRE
 MEUBLE 60 CM AVEC 1 TIROIR - BLANC ET SAPHIR | SHORT - VASQUE EN CÉRAMIQUE 61 CM | KEEN - MITIGEUR LAVABO | LISTA MIROIR 60 CM - SAPHIR
 MUEBLE 60 CM CON 1 CAJÓN - BLANCO Y ZAFIRO | SHORT LAVABO INTEGRAL DE PORCELANA 61 CM | KEEN - LAVABO MONOMANDO | LISTA ESPEJO 60CM - ZAFIRO



50 CM BASE UNIT WITH 2 DRAWERS - WHITE AND EGGPLANT | SHORT - CERAMIC COUNTERTOP WASHBASIN 51 CM
 TALL CABINET WITH 2 DOORS - WHITE AND EGGPLANT | SMART - SINGLE LEVER BASIN MIXER | LISTA MIRROR 50 CM - EGGPLANT
 MEUBLE 50 CM AVEC 2 TIROIRS - BLANC ET AUBERGINE | SHORT - VASQUE EN CÉRAMIQUE 51 CM | SMART - MITIGEUR LAVABO
 COLLONE AVEC 2 PORTES - BLANC ET AUBERGINE | LISTA MIROIR 50 CM - AUBERGINE
 MUEBLE 50 CM CON 2 CAJONES - BLANCO Y BERENJENA | SHORT LAVABO INTEGRAL DE PORCELANA 51 CM
 SMART - LAVABO MONOMANDO | COLUMNA CON 2 PUERTAS - BLANCO Y BERENJENA | LISTA ESPEJO 50CM - BERENJENA

SUSPENDED BASE UNIT W/ 2 DRAWERS AND SHORT COUNTERTOP WASHBASIN
 MEUBLE SUSPENDU AVEC 2 TIROIR ET SHORT LAVABO
 MUEBLE SUSPENDIDO CON 1 CAJÓN Y SHORT LAVABO

<p>50 - 60 - 80 - 100</p>	<p>WHITE BLANC BLANCO</p>	<p>WHITE + BELLIAN C BLANC + C. BELLIAN BLANCO + C. BELLIAN</p>	<p>BELLIAN COLOURS COULEURS BELLIAN COLORES BELLIAN</p>	<p>RAL COLOURS COULEURS RAL COLORES RAL</p>
	50			
	60			
	80			
	100			

TALL CABINET WITH 2 DOORS
 COLLONE AVEC 2 PORTES
 COLUMNA CON 2 PUERTAS

<p>110 - 30 - 20</p>	<p>WHITE BLANC BLANCO</p>	<p>WHITE + BELLIAN C BLANC + C. BELLIAN BLANCO + C. BELLIAN</p>	<p>BELLIAN COLOURS COULEURS BELLIAN COLORES BELLIAN</p>	<p>RAL COLOURS COULEURS RAL COLORES RAL</p>
	30			

LISTA

MIRROR // MIROIR // ESPEJO

<p>50 - 60 - 80 - 100</p>	<p>WHITE BLANC BLANCO</p>	<p>BELLIAN COLOURS COULEURS BELLIAN COLORES BELLIAN</p>	<p>RAL COLOURS COULEURS RAL COLORES RAL</p>
	50		
	60		
	80		
	100		

LEO

LED LIGHT FIXTURE // APPLIQUE LED // APLIQUE LED

<p>30 - 3 - 13</p>	<p>WHITE BLANC BLANCO</p>	<p>BELLIAN COLOURS COULEURS BELLIAN COLORES BELLIAN</p>	<p>RAL COLOURS COULEURS RAL COLORES RAL</p>
	30		

VERO

HALOGEN LIGHT FIXTURE
 APPLIQUE HALOGENE // APLIQUE HALÓGENO

<p>25.5 - 3 - 13</p>	<p>CHROME CHROMÉ CROMO</p>	<p>MATTE MATE MATE</p>
	25.5	



100 CM BASE UNIT WITH 2 DRAWERS - WHITE AND BEIGE | SHORT - CERAMIC COUNTERTOP WASHBASIN 101 CM | KEEN - SINGLE LEVER BASIN MIXER | LISTA MIRROR 100 CM - BEIGE
 MEUBLE 100 CM AVEC 2 TIROIRS - BLANC ET BEIGE | SHORT - VASQUE EN CÉRAMIQUE 101 CM | KEEN - MITIGEUR LAVABO | LISTA MIROIR 100 CM - BEIGE
 MUEBLE 100 CM CON 2 CAJONES - BLANCO Y BEIGE | SHORT LAVABO INTEGRAL DE PORCELANA 101 CM | KEEN - LAVABO MONOMANDO | LISTA ESPEJO 100CM - BERENJENA



60 CM BASE UNIT WITH 2 DRAWERS AND 1 DOOR - WHITE AND ANTHRACITE
 ZIP - CERAMIC COUNTERTOP WASHBASIN 60CM
 TALL CABINET WITH 2 DOORS - WHITE AND ANTHRACITE | KNOBE - SINGLE LEVER BASIN
 MIXER | LIGHT H MIRROR WITH MAGNIFYING 60 CM
 MEUBLE 60 CM AVEC 2 TIROIRS ET 1 PORTE - BLANC ET ANTHRACITE
 ZIP - VASQUE EN CÉRAMIQUE 51 CM | KNOBE - MITIGEUR LAVABO | COLLONE AVEC
 2 PORTES - BLANC ET ANTHRACITE | LIGHT H MIROIR AVEC GROSSISSANT 60 CM
 MUEBLE 60 CM CON 2 CAJONES Y 1 PUERTA - BLANCO Y ANTRACITE
 ZIP LAVABO INTEGRAL DE PORCELANA 60 CM
 KNOBE - LAVABO MONOMANDO | COLUMNA CON 2 PUERTAS - BLANCO Y ANTRACITE
 | LIGHT H ESPEJO CON ESPEJO AUMENTO 60CM

SUSPENDED BASE UNIT W/ 2 DRAWERS, 1 DOOR AND ZIP COUNTERTOP WASHBASIN
 MEUBLE SUSPENDU AVEC 2 TIROIRS, 1 PORTE ET ZIP LAVABO
 MUEBLE SUSPENDIDO CON 2 CAJONES, 1 PUERTA Y ZIP LAVABO



TALL CABINET WITH 2 DOORS
 COLLONE AVEC 2 PORTES
 COLUMNA CON 2 PUERTAS



LISTA

MIRROR // MIROIR // ESPEJO

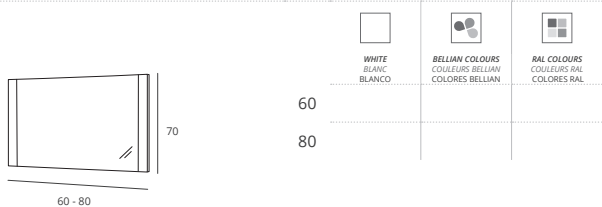

LISO

MIRROR WITH CHROMED FRAME
 MIROIR AVEC CADRE CHROMÉ
 ESPEJO CON MARCO CROMO

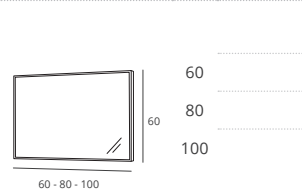

LIGHT H

MIRROR WITH MAGNIFYING
 MIROIR AVEC GROSSISSANT
 ESPEJO CON ESPEJO DE AUMENTO

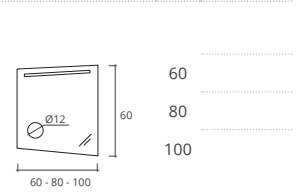



MINI 35
 REDUCED DEPTH
 PROFONDEUR RÉDUITE
 PROFUNDIDAD REDUCIDA

80 CM BASE UNIT WITH 2 DRAWERS AND 1 DOOR - WHITE AND EGGPLANT | ZIP - CERAMIC COUNTERTOP WASHBASIN 80CM | TALL CABINET WITH 2 DOORS - WHITE AND EGGPLANT | ORION - SINGLE LEVER BASIN MIXER
 LISTA MIRROR 80 CM - EGGPLANT | VERO HALOGEN LIGHT FIXTURE
 MEUBLE 80 CM AVEC 2 TIROIRS ET 1 PORTE - BLANC ET AUBERGINE | ZIP - VASQUE EN CÉRAMIQUE 80 CM | ORION - MITIGEUR LAVABO | COLLONE AVEC 2 PORTES - BLANC ET AUBERGINE | LISTA MIROIR 80 CM - AUBERGINE | VERO APPLIQUE HALOGÈNE
 MUEBLE 80 CM CON 2 CAJONES ET 1 PUERTA - BLANCO Y BERENJENA | ZIP LAVABO INTEGRAL DE PORCELANA 80 CM | ORION - LAVABO MONOMANDO | COLUMNA CON 2 PUERTAS - BLANCO Y BERENJENA | LISTA ESPEJO 80 CM - BERENJENA | VERO APPLIQUE HALÓGENO

LEO
 LED LIGHT FIXTURE
 APPLIQUE LED // APLIQUE LED

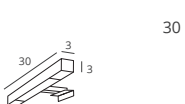

VERO
 HALOGEN LIGHT FIXTURE
 APPLIQUE HALOGÈNE // APLIQUE HALÓGENO

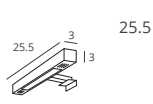

CHROME
 CHROMÉ
 CROMO

MATTE
 MATE
 MATE





100 CM BASE UNIT WITH 2 DRAWERS - WHITE AND EGGPLANT
 GLASS COUNTERTOP WASHBASIN 101CM - EGGPLANT | TALL CABINET WITH 2
 DOORS - WHITE AND EGGPLANT | KNOBE - SINGLE LEVER BASIN MIXER | LISTA
 MIRROR 100 CM - EGGPLANT | VERO HALOGEN APLIQUE
 MEUBLE 100 CM AVEC 2 TIROIRS - BLANC ET AUBERGINE
 VASQUE EN VERRE 101 CM - AUBERGINE | KNOBE - MITIGEUR LAVABO COLLONE
 AVEC 2 PORTES - BLANC ET AUBERGINE | LISTA MIROIR 100 CM - AUBERGINE
 VERO APLIQUE HALOGENE
 MUEBLE 100 CM CON 2 CAJONES - BLANCO Y BERENJENA
 LAVABO DE CRISTAL DE ENCIMERA 101 CM - BERENJENA
 KNOBE - LAVABO MONOMANDO | COLUMNA CON 2 PUERTAS - BLANCO Y
 BERENJENA | LISTA ESPEJO 100CM - BERENJENA | VERO APLIQUE HALOGENO

SUSPENDED BASE UNIT W/ 2 DRAWERS AND COUNTERTOP WASHBASIN
 MEUBLE SUSPENDU AVEC 2 TIROIRS ET LAVABO
 MUEBLE SUSPENDIDO CON 2 CAJONES Y LAVABO

	 WHITE // BLANC // BLANCO	 WHITE + BELLIAN C. // BLANC + C. BELLIAN // BLANCO + C. BELLIAN	 BELLIAN COLOURS // COULEURS BELLIAN // COLORES BELLIAN	 RAL COLOURS // COULEURS RAL // COLORES RAL
	WITH WASHBASIN // AVEC VASQUE // CON LAVABO			
	GLASS // VERRE // CRISTAL 	CERAMIC CÉRAMIQUE PORCELANA (MODERN)	GLASS // VERRE // CRISTAL 	CERAMIC CÉRAMIQUE PORCELANA (MODERN)
60				
80				
100				

TALL CABINET WITH 2 DOORS
 COLLONE AVEC 2 PORTES
 COLUMNA CON 2 PUERTAS

	 WHITE BLANC BLANCO	 WHITE + BELLIAN C. BLANC + C. BELLIAN BLANCO + C. BELLIAN	 BELLIAN COLOURS COULEURS BELLIAN COLORES BELLIAN	 RAL COLOURS COULEURS RAL COLORES RAL
	30			

BASE UNIT FOOT (UNIT)
 PIED POUR MEUBLE (UNITÉ)
 PATA DE MUEBLE (UNIDAD)

	GLOSSY BRILLANT BRILLANT
3.5	

LISTA

MIRROR // MIROIR // ESPEJO

	 WHITE BLANC BLANCO	 BELLIAN COLOURS COULEURS BELLIAN COLORES BELLIAN	 RAL COLOURS COULEURS RAL COLORES RAL
	60		
	80		
	100		

LISO

MIRROR WITH CHROMED FRAME
 MIROIR AVEC CADRE CHROMÉ
 ESPEJO CON MARCO CROMO

	60
	80
	100

LIGHT H

MIRROR WITH MAGNIFYING
 MIROIR AVEC GROSSISSANT
 ESPEJO CON ESPEJO DE AUMENTO

	60
	80
	100



100 CM BASE UNIT WITH 2 DRAWERS - WHITE AND ANTHRACITE | GLASS COUNTERTOP WASHBASIN 101CM - ANTHRACITE | TALL CABINET WITH 2 DOORS - WHITE AND ANTHRACITE | NEXT - SINGLE LEVER BASIN MIXER
 LISTA MIRROR 80 CM - EGGPLANT | VERO HALOGEN LIGHT FIXTURE | BASE UNIT FOOT (4 UNITS)
 MEUBLE 80 CM AVEC 2 TIROIRS ET 1 PORTE - BLANC ET ANTHRACITE | VASQUE EN VERRE 101 CM - ANTHRACITE | NEXT - MITIGEUR LAVABO | COLLONE AVEC 2 PORTES - BLANC ET ANTHRACITE | LISTA MIROIR 100 CM - ANTHRACITE
 VERO APPLIQUE HALOGENE | PIED POUR MEUBLE (4 UNITÉS)
 MUEBLE 100 CM CON 2 CAJONES - BLANCO Y ANTRACITE | LAVABO DE CRISTAL DE ENCIMERA 101 CM - ANTRACITE | NEXT - LAVABO MONOMANDO | COLUMNNA CON 2 PUERTAS - BLANCO Y ANTRACITE
 LISTA ESPEJO 80 CM - BERENJENA | VERO APLIQUE HALÓGENO | PATA DE MUEBLE (4 UNIDADES)

LEO

LED LIGHT FIXTURE
 APPLIQUE LED // APLIQUE LED



VERO

HALOGEN LIGHT FIXTURE
 APPLIQUE HALOGENE // APLIQUE HALÓGENO



CHROME
 CHROME
 CROMO

MATTE
 MATE
 MATE











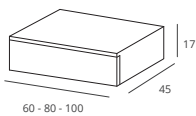

80 CM BASE UNIT WITH 1 DRAWER - GRAFITE WENGE | ICEBERG Ø42 CM - CERAMIC COUNTERTOP WASHBASIN
 TYPE - SINGLE LEVER TALL BASIN MIXER | LISO MIRROR WITH CHROMED FRAME 80 CM | BELL HALOGEN APPLIQUE
 MEUBLE 80 CM AVEC 1 TIROIR - WENGE GRAFITE | ICEBERG Ø42 CM - VASQUE À POSER EN CÉRAMIQUE
 TYPE - MITIGEUR LAVABO HAUT | LISO MIROIR AVEC CADRE CHROMÉ | BELL APPLIQUE HALOGÈNE
 MUEBLE 80 CM CON 1 CAJÓN - WENGER GRAFITO | ICEBERG Ø42 CM LAVABO DE PORCELANA DE POSAR
 TYPE - LAVABO ALTO MONOMANDO | LISTA ESPEJO CON MARCO CROMO | BELL APPLIQUE HALÓGENO

60 CM BASE UNIT WITH 1 DRAWER - WHITE | FREEZE 38 CM - CERAMIC COUNTERTOP WASHBASIN | TYPE - SINGLE LEVER
 BASIN MIXER | LISO MIRROR WITH CHROMED FRAME 60 CM | BELL HALOGEN APPLIQUE
 MEUBLE 60 CM AVEC 1 TIROIR - BLANC | FREEZE 38 CM - VASQUE À POSER EN CÉRAMIQUE
 TYPE - MITIGEUR LAVABO | LISO MIROIR AVEC CADRE CHROMÉ 60 CM | BELL APPLIQUE HALOGÈNE
 MUEBLE 60 CM CON 1 CAJÓN - BLANCO | FREEZE 38 CM LAVABO DE PORCELANA DE POSAR
 TYPE - LAVABO MONOMANDO | LISTA ESPEJO CON MARCO CROMO | BELL APPLIQUE HALÓGENO

SUSPENDED BASE UNIT W/ 1 DRAWER
 MEUBLE SUSPENDU AVEC 1 TIROIR
 MUEBLE SUSPENDIDO CON 1 CAJÓN



						
WHITE BLANC BLANCO	ESTEPA W. B. ESTEPA M. ESTEPA	TAIGA W. B. TAIGA M. TAIGA	CHERRY W. B. CEREZO M. CERIEJO	G. WENGE WENGE G. WENGER G.	BELLIAN COLOURS COULEURS BELLIAN COLORES BELLIAN	RAL COLOURS COULEURS RAL COLORES RAL
60						
80						
100						

MOLDURA
 MIRROR WITH FRAME
 MIROIR AVEC CADRE
 ESPEJO CON MARCO

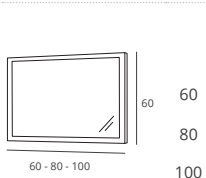

LISO
 MIRROR WITH CHROMED FRAME
 MIROIR AVEC CADRE CHROMÉ
 ESPEJO CON MARCO CROMO

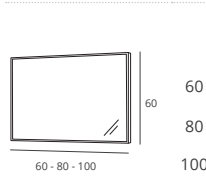

LEO
 LED LIGHT FIXTURE
 APPLIQUE LED
 APPLIQUE LED

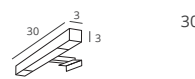

VERO
 HALOGEN LIGHT FIXTURE
 APPLIQUE HALOGÈNE
 APPLIQUE HALÓGENO



CHROME
CHROME
CROMO

MATTE
MATE
MATE

COTTON
 CERAMIC COUNTERTOP WASHBASIN
 VASQUE À POSER EN CÉRAMIQUE
 LAVABO DE PORCELANA DE POSAR



FREEZE
 CERAMIC COUNTERTOP WASHBASIN
 VASQUE À POSER EN CÉRAMIQUE
 LAVABO DE PORCELANA DE POSAR

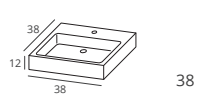

GLACIAR
 CERAMIC COUNTERTOP WASHBASIN
 VASQUE À POSER EN CÉRAMIQUE
 LAVABO DE PORCELANA DE POSAR

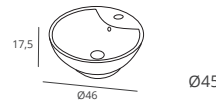

BELL
 HALOGEN LIGHT FIXTURE
 APPLIQUE HALOGÈNE
 APPLIQUE HALÓGENO

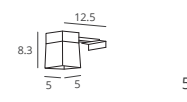



80 CM BASE UNIT WITH 1 DRAWER - CHERRY WOOD | COTTON Ø39 CM - CERAMIC COUNTERTOP WASHBASIN | NIX - SINGLE LEVER TALL BASIN MIXER | LISO MIRROR WITH CHROMED FRAME 80 CM
 MEUBLE 80 CM AVEC 1 TIROIR - BOIS CERISE | COTTON Ø39 CM - VASQUE À POSER EN CÉRAMIQUE | NIX - MITIGEUR LAVABO HAUT | LISO MIROIR AVEC CADRE CHROMÉ 80 CM
 MUEBLE 80 CM CON 1 CAJÓN - MADERA CEREJO | COTTON Ø39 CM LAVABO DE PORCELANA DE POSAR | NIX - LAVABO ALTO MONOMANDO | LISTA ESPEJO CON MARCO CROMO



DRAWER WITH CLICK OPENING

Drawer without handle with easy opening through a light touch. To close just press lightly until you feel a "click". Simple and comfortable solution for everyday use.

TIROIR AVEC OUVERTURE CLICK

Tiroir sans poignée avec ouverture facile grâce à une légère touche. Pour fermer simplement presser légèrement jusqu'à ce que vous sentiez un «clic». Solution simple et confortable pour l'usage quotidien.

CAJÓN CON APERTURA CLICK

Cajón sin tirador con fácil apertura mediante un ligero toque. Para cerrar basta pulsar suavemente hasta que sienta un "clic". Solución simple y cómoda para el uso diario.



80 CM BASE UNIT WITH 3 DRAWERS - BLACK | MODERN - CERAMIC COUNTERTOP WASHBASIN | ORION - SINGLE LEVER BASIN MIXER | MIRROR WITH FRAME 80 CM - WHITE
 MEUBLE 80 CM AVEC 3 TIROIRS - NOIR | MODERN - PLAN VASQUE EN CÉRAMIQUE | ORION - MITIGEUR LAVABO | MIROIR AVEC CADRE 80 CM - BLANC
 MUEBLE 80 CM CON 3 CAJONES - NEGRO | MODERN - LAVABO INTEGRAL DE PORCELANA | ORION - LAVABO MONOMANDO | ESPEJO CON MARCO 80 CM - BLANCO

BASE UNIT W/ 3 DRAWERS
 MEUBLE AVEC 3 TIROIRS
 MUEBLE CON 3 CAJONES

WHITE BLANC	ESTEPA W. B. ESTEPA M. ESTEPA	TAIGA W. B. TAIGA M. TAIGA	CHERRY WOOD BOIS CERISE MADERA CERISE	GRAFITE WENGE WENGE GRAFITE WENGER GRAFITO	BELLIAN COLOURS COULEURS BELLIAN COLORES BELLIAN	RAL COLOURS COULEURS RAL COLORES RAL

WITH WASHBASIN // AVEC VASQUE // CON LAVABO

GLASS // VERRE // CRISTAL	CERAMIC CÉRAMIQUE PORCELANA (MODERN)	GLASS // VERRE // CRISTAL	CERAMIC CÉRAMIQUE PORCELANA (MODERN)	GLASS // VERRE // CRISTAL	CERAMIC CÉRAMIQUE PORCELANA (MODERN)	GLASS // VERRE // CRISTAL	CERAMIC CÉRAMIQUE PORCELANA (MODERN)
60		60		60		60	
80		80		80		80	
100		100		100		100	

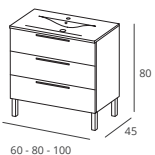

LEO

LED LIGHT FIXTURE // APPLIQUE LED // APLIQUE LED



30

VERO

HALOGEN LIGHT FIXTURE // APPLIQUE HALOGÈNE // APLIQUE HALÓGENO



25.5

CHROME
CHROME
CROMO

MATTE
MATE
MATE

BELL

HALOGEN LIGHT FIXTURE // APPLIQUE HALOGÈNE // APLIQUE HALÓGENO



5



100 CM BASE UNIT WITH 3 DRAWERS - CHERRY WOOD | MODERN - CERAMIC COUNTERTOP WASHBASIN 101 CM
 FOCUS - SINGLE LEVER BASIN MIXER | MIRROR WITH CHROMED FRAME 100 CM
 MEUBLE 100 CM AVEC 3 TIROIRS - BOIS CERISE | MODERN - PLAN VASQUE EN CÉRAMIQUE
 FOCUS - MITIGEUR LAVABO | MIROIR AVEC CADRE CHROMÉ 100 CM
 MUEBLE 100 CM CON 3 CAJONES - MADERA CEREJO | MODERN - LAVABO INTEGRAL DE PORCELANA
 FOCUS - LAVABO MONOMANDO | ESPEJO CON MARCO CROMO 100 CM

MIRROR WITH FRAME
 MIROIR AVEC CADRE
 ESPEJO CON MARCO

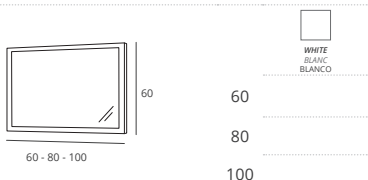

LISO

MIRROR WITH CHROMED FRAME
 MIROIR AVEC CADRE CHROMÉ
 ESPEJO CON MARCO CROMO

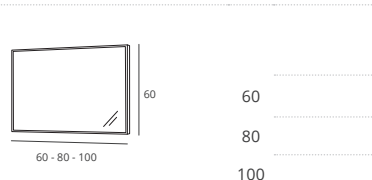



50 CM BASE UNIT WITH 1 DOOR - TAIGA WOOD | FOZ - CERAMIC COUNTERTOP WASHBASIN
 ORION - SINGLE LEVER BASIN MIXER | LESS MIRROR 50 CM
 MEUBLE 50 CM AVEC 1 PORTE - BOIS TAIGA | FOZ - PLAN VASQUE EN CÉRAMIQUE
 ORION - MITIGEUR LAVABO | LESS MIROIR 50 CM
 MUEBLE 50 CM CON 1 PUERTA - MADERA TAIGA | FOZ - LAVABO INTEGRAL DE PORCELANA
 ORION - LAVABO MONOMANDO | LESS ESPEJO 50 CM



80 CM BASE UNIT WITH 2 DOORS AND 2 DRAWERS - TAIGA WOOD | MODERN - CERAMIC COUNTERTOP WASHBASIN 81 CM
 ORION - SINGLE LEVER BASIN MIXER | SIMPLES MIRROR 80 CM | BASE UNIT FOOT (4 UNITS)
 MEUBLE 80 CM AVEC 2 PORTES ET 2 TIROIRS - BOIS TAIGA | MODERN - PLAN VASQUE EN CÉRAMIQUE
 ORION - MITIGEUR LAVABO | SIMPLES MIROIR 80 CM | PIEDS POUR MEUBLE (4 UNITÉS)
 MUEBLE 80 CM CON 2 PUERTAS Y 2 CAJONES - MADERA TAIGA | MODERN - LAVABO INTEGRAL DE PORCELANA ORION
 - LAVABO MONOMANDO | SIMPLES ESPEJO 80 CM | PATA DE MUEBLE (4 UNIDADES)

BASE UNIT W/ DOOR OR DOORS AND DRAWERS
 MEUBLE AVEC PORTE O PORTES ET TIROIRS
 MUEBLE CON PUERTA OU CON PUERTAS E CAJONES

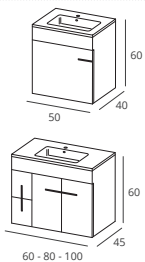

	WHITE BLANC BLANCO	ESTEPA W. B. ESTEPA M. ESTEPA	TAIGA W. B. TAIGA M. TAIGA	CHERRY WOOD BOIS CERISE MADERA CEREJO	GRANITE WENGE WEGHE GRANIT WENGER GRANITO	BELLIAN COLOURS COULEURS BELLIAN COLORES BELLIAN	RAL COLOURS COULEURS RAL COLORES RAL		
WITH WASHBASIN // AVEC VASQUE // CON LAVABO									
	GLASS // VERRE // CRISTAL		CERAMIC CÉRAMIQUE PORCELANA (MODERN)	GLASS // VERRE // CRISTAL		CERAMIC CÉRAMIQUE PORCELANA (MODERN)	GLASS // VERRE // CRISTAL		CERAMIC CÉRAMIQUE PORCELANA (MODERN)
50*	-	-	*	-	-	*	-	-	*
60									
80									
100									

*FOR THE MEASURE 50 CM IS USED THE BASIN FOZ // DANS LA MÉSURE DE 50 CM EST UTILISÉ LE LAVABO FOZ // EN LA MEDIDA DE 50 CM SE UTILIZA EL LAVABO FOZ

LEO

LED LIGHT FIXTURE // APPLIQUE LED // APLIQUE LED

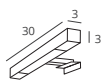

30

VERO

HALOGEN LIGHT FIXTURE // APPLIQUE HALOGÈNE // APLIQUE HALÓGENO

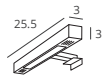

25.5

CHROME
CHROMÉ
CROMO

MATTE
MATE
MATE

BELL

HALOGEN LIGHT FIXTURE // APPLIQUE HALOGÈNE // APLIQUE HALÓGENO

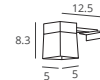

5

LISO

MIRROR WITH CHROMED FRAME
 MIROIR AVEC CADRE CHROMÉ
 ESPEJO CON MARCO CROMO

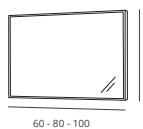

60

100

SIMPLES

MIRROR // MIROIR // ESPEJO

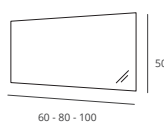

50

100

BASE UNIT FOOT (UNIT)

PIED POUR MEUBLE (UNITÉ)
 PATA DE MUEBLE (UNIDAD)

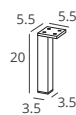

3.5

GLOSSY
BRILLANT
BRILLANT



100 CM BASE UNIT WITH 2 DOORS AND 2 DRAWERS - GRAFITE WENGE | MODERN - CERAMIC COUNTERTOP WASHBASIN 101 CM
FOCUS - SINGLE LEVER BASIN MIXER | SIMPLES MIRROR 100 CM | BELL HALOGEN LIGHT FIXTURE
 MEUBLE 100 CM AVEC 2 PORTES ET 2 TIROIRS - WENGÉ GRAFITE | MODERN - PLAN VASQUE EN CÉRAMIQUE 101 CM
 FOCUS - MITTGEUR LAVABO | SIMPLES MIROIR 100 CM | BELL APPLIQUE HALGONÈNE
MUEBLE 100 CM CON 2 PUERTAS Y 2 CAJONES - WENGER GRAFITO | MODERN - LAVABO INTEGRAL DE PORCELANA 101 CM
 FOCUS - LAVABO MONOMANDO | SIMPLES ESPEJO 100 CM | BELL APLIQUE HALÓGENO



120 CM BASE UNIT WITH 2 DOORS AND 4 DRAWERS - CHERRY WOOD | MODERN - CERAMIC COUNTERTOP WASHBASIN 121 CM - 1 SINK | FOCUS - SINGLE LEVER BASIN MIXER | LESS MIRROR WITH LEDS 120 CM | BASE UNIT FOOT (UNIT) - CHROME
 MEUBLE 120 CM AVEC 2 PORTES ET 4 TIROIRS - BOIS CERISE | MODERN - PLAN VASQUE EN CÉRAMIQUE 121 CM - 1 CUVE | FOCUS - MITIGEUR LAVABO | LESS MIROIR AVEC LEDS 120 CM | PIED POUR MEUBLE (UNITÉ) - CHROMÉ
 MUEBLE 120 CM CON 2 PUERTAS Y 4 CAJONES - MADERA CEREJO | MODERN - LAVABO INTEGRAL DE PORCELANA 121 CM - 1 PIA | FOCUS - LAVABO MONOMANDO | LESS ESPEJO CON LEDS 120 CM | PATA DE MUEBLE (UNIDADE) - CROMO

BASE UNIT W/ DOORS AND DRAWERS

MEUBLE AVEC PORTES ET TIROIRS

MUEBLE CON PUERTAS E CAJONES

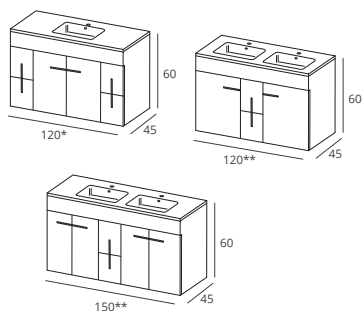

* 1 BOWL // 2 CUVE // 2 PIA ** 2 BOWLS // 2 CUVES // 2 PIAS

WHITE BLANC BLANCO	ESTEPA W. B. ESTEPA M. ESTEPA	TAIGA W. B. TAIGA M. TAIGA	CHERRY WOOD BOIS CERISE MADERA CEREJO	GRAFITE WENGE WEGNE GRAFITO WENGER GRAFITO	BELLIAN COLOURS COULEURS BELLIAN COLORES BELLIAN	RAL COLOURS COULEURS RAL COLORES RAL	
WITH WASHBASIN // AVEC VASQUE // CON LAVABO							
GLASS // VERRE // CRISTAL	CERAMIC CÉRAMIQUE PORCELANA (MODERN)	GLASS // VERRE // CRISTAL	CERAMIC CÉRAMIQUE PORCELANA (MODERN)	GLASS // VERRE // CRISTAL	CERAMIC CÉRAMIQUE PORCELANA (MODERN)	GLASS // VERRE // CRISTAL	CERAMIC CÉRAMIQUE PORCELANA (MODERN)
120*		120**		120*		120**	
120**				120**			
150**				150**			

LESS // LESS LEDS

MIRROR // MIROIR // ESPEJO

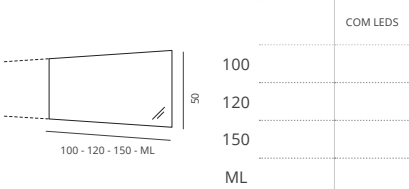

BASE UNIT FOOT (UNIT)

PIED POUR MEUBLE (UNITÉ)

PATA DE MUEBLE (UNIDAD)

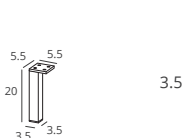

3.5

GLOSSY
BRILLANT
BRILLANT

VERO

HALOGEN LIGHT FIXTURE // APPLIQUE HALOGÈNE // APLIQUE HALÓGENO



25.5

CHROME
CHROME
CROMO

MATTE
MATE
MATE



150 CM BASE UNIT WITH 4 DOORS AND 2 DRAWERS - WHITE AND BLACK | MODERN - CERAMIC COUNTERTOP WASHBASIN 151 CM - 2 SINKS | 2 UNITS KEEN - SINGLE LEVER BASIN MIXER | LESS MIRROR 150 CM | BASE UNIT FOOT (4 UNITS) - CHROME
 MEUBLE 150 CM AVEC 4 PORTES ET 2 TIROIRS - BLANC ET NOIR | MODERN - PLAN VASQUE EN CÉRAMIQUE 151 CM - 2 CUVES | 2 UNITÉS KEEN - MITIGEUR LAVABO | LESS MIROIR 150 CM | PIED POUR MEUBLE (4 UNITÉS) - CHROMÉ
 MUEBLE 150 CM CON 4 PUERTAS Y 2 CAJONES - BLANCO Y NEGRO | MODERN - LAVABO INTEGRAL DE PORCELANA 151 CM - 2 PIAS | 2 UNIDADES KEEN - LAVABO MONOMANDO | LESS ESPEJO 150 CM | PATA DE MUEBLE (4 UNIDADES) - CROMO

MORE SPACE MORE OPTIONS

Bellian® gives you the opportunity to furnish large bathroom spaces with spacious and functional furniture, according to the requirements of numerous families and even for those who value the storage space in the bath space. So, we present a wide range of options with furniture with different configurations and finishes and allow to place 120 cm countertop with one or two basins or even 150 cm with two basins for practical daily use and tailored to your needs.

PLUS D'ESPACE PLUS D'OPTIONS

Bellian® vous donne la possibilité de meubler grands espaces de salle de bains avec des meubles spacieux et fonctionnels, selon les exigences des familles nombreux et même pour ceux qui apprécient l'espace dans la salle de bains. Donc, nous présentons une large gamme d'options des meubles de différentes configurations et finitions et que vous permet le placement de lavabos de 120 cm avec un ou deux vasques ou même 150 cm avec deux vasques pour une utilisation quotidienne pratique et adapté à vos besoins.

MAS ESPACIO MAS OPCIONES

Bellian® le da la oportunidad de amueblar grandes espacios de baño con muebles amplios y funcionales, de acuerdo con los requisitos de familias numerosas e incluso para aquellos que valoran el almacenaje en el baño. Así se presenta una amplia gama de opciones con muebles de diferentes configuraciones y acabados que permiten la colocación de lavabos de 120 cm con uno o dos pias o incluso de 150 cm con una pia para el uso diario práctico y adaptado a sus necesidades.

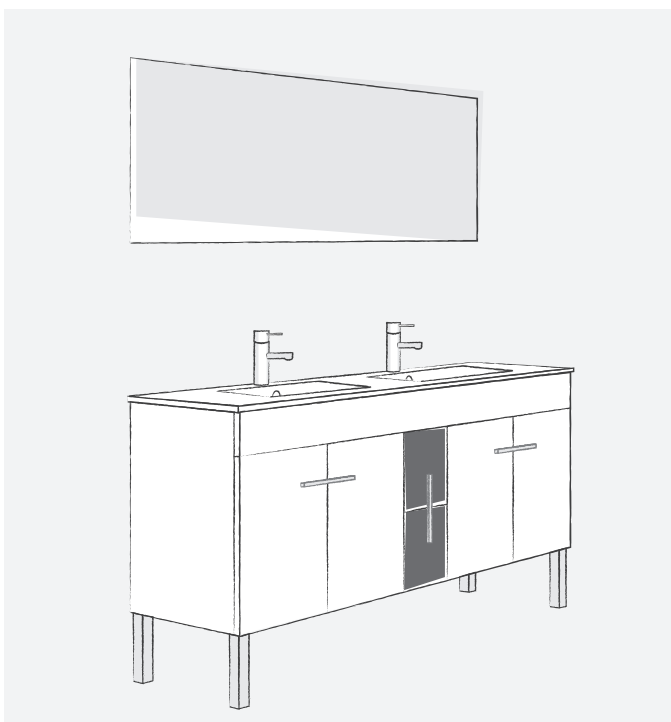



60 CM BASE UNIT WITH 2 DRAWERS - WHITE | GLASS COUNTERTOP WASHBASIN 61 CM - GREEN HARPA - SINGLE LEVER BASIN MIXER | MIRROR WITH WHITE FRAME 60 CM
 MEUBLE 60 CM AVEC 2 TIROIRS - BLANC | VASQUE EN VERRE 61 CM - VERT | HARPA - MITIGEUR LAVABO | MIROIR AVEC CADRE BLANC 60 CM
 MUEBLE 60 CM CON 2 CAJONES - BLANCO | LAVABO DE CRISTAL DE ENCIMERA 61 CM HARPA - LAVABO MONOMANDO | ESPEJO CON MARCO BLANCO 60 CM



80 CM BASE UNIT WITH 2 DRAWERS - WENGE | MODERN CERAMIC COUNTERTOP WASHBASIN 81 CM ORION - SINGLE LEVER BASIN MIXER | MIRROR WITH CHROMED FRAME 80 CM
 MEUBLE 80 CM AVEC 2 TIROIRS - WENGÉ | MODERN VASQUE EN CÉRAMIQUE 81 CM ORION - MITIGEUR LAVABO | MIROIR AVEC CADRE CHROMÉ 80 CM
 MUEBLE 80 CM CON 2 CAJONES - WENGER | LAVABO INTEGRAL DE PORCELANA 81 CM ORION - LAVABO MONOMANDO | ESPEJO CON MARCO CROMO 80 CM

BASE UNIT WITH DRAWERS
 MEUBLE AVEC TIROIRS
 MUEBLE CON CAJONES

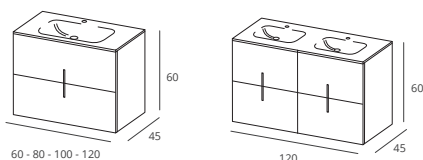

* 1 BOWL // 2 CUVES // 2 PIA ** 2 BOWLS // 2 CUVES // 2 PIAS

	WHITE BLANC BLANCO	WENGE WENGÉ WENGER	BELLIAN COLOURS COULEURS BELLIAN COLORES BELLIAN	RAL COLOURS COULEURS RAL COLORES RAL
WITH WASHBASIN // AVEC VASQUE // CON LAVABO				
	GLASS // VERRE // CRISTAL	CERAMIC CÉRAMIQUE PORCELANA (MODERN)	GLASS // VERRE // CRISTAL	CERAMIC CÉRAMIQUE PORCELANA (MODERN)
60				
80				
100				
120*				
120**				

LISO

MIRROR WITH CHROMED FRAME
 MIROIR AVEC CADRE CHROME
 ESPEJO CON MARCO CROMO

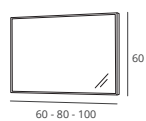

MIRROR WITH FRAME
 MIROIR AVEC CADRE
 ESPEJO CON MARCO

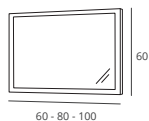

WHITE
BLANC
BLANCO

LISTA

MIRROR // MIROIR // ESPEJO

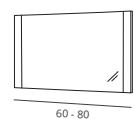

WHITE
BLANC
BLANCO

BELLIAN C.
C. BELLIAN
C. BELLIAN

RAL CO.
C. RAL
C. RAL

LEO

LED LIGHT FIXTURE // APPLIQUE LED // APLIQUE LED



30

VERO

HALOGEN LIGHT FIXTURE // APPLIQUE HALOGÈNE // APLIQUE HALÓGENO



25.5

CHROME
CHROME
CROMO

MATTE
MATE
MATE

BELL

HALOGEN LIGHT FIXTURE // APPLIQUE HALOGÈNE // APLIQUE HALÓGENO



5



120 CM BASE UNIT WITH 2 DRAWERS - WHITE | GLASS COUNTERTOP WASHBASIN 121 CM | HARPA - SINGLE LEVER BASIN MIXER
 MIRROR WITH WHITE FRAME 120 CM | BASE UNIT FOOT (4 UNITS) - MATTE
 MEUBLE 120 CM AVEC 2 TIROIRS - BLANC | VASQUE EN VERRE 121 CM | HARPA - MITIGEUR LAVABO | MIROIR AVEC CADRE BLANC 120 CM
 PIED POUR MEUBLE (4 UNITÉS) - MATE
 MUEBLE 120 CM CON 2 CAJÓNES - BLANCO | LAVABO DE CRISTAL DE ENCIMERA 121 CM | HARPA - LAVABO MONOMANDO
 ESPEJO CON MARCO BLANCO 120 CM | PATA DE MUEBLE (4 UNIDADES) - CROMO

BASE UNIT FOOT (UNIT)
 PIED POUR MEUBLE (UNITÉ)
 PATA DE MUEBLE (UNIDAD)



3.5

 MATTE
 MATE
 MATE

REFLEX

COLLECTION

MIRRORS & LIGHT FIXTURES
MIROIRS & APPLIQUES
ESPEJOS & APLIQUES

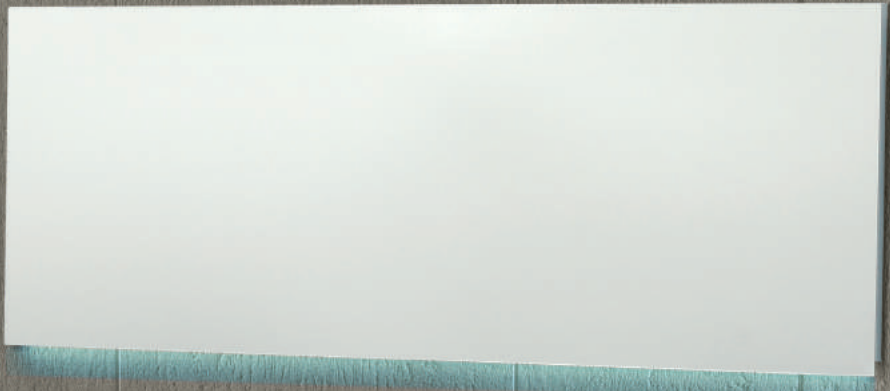

Sensor to regulate the intensity of light
Capteur pour régulation de l'intensité de lumière
Sensor para regular la intensidad de la luz

LESS LEDS

MIRROR WITH LEDS STRIP AND SENSOR // MIROIR AVEC BANDE LEDS ET CAPTEUR // ESPEJO CON TIRA DE LEDS Y SENSOR

- 50 X 50 CM
- 60 X 50 CM
- 70 X 50 CM
- 80 X 50 CM
- 90 X 50 CM

- 100 X 50 CM
- 120 X 50 CM
- 140 X 50 CM
- 150 X 50 CM

LINEAL METRE
 MÈTRE LINÉAIRE
 METRO LINEAL

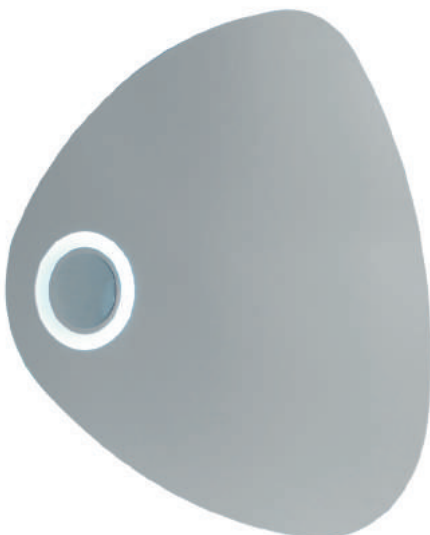

with magnifying
avec grossissant
con espejo de aumento

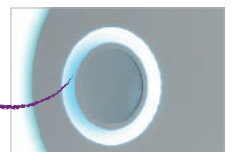

DELTA

MIRROR WITH LEDS STRIP // MIROIR AVEC BANDE LEDS // ESPEJO CON TIRA DE LEDS

- 70 X 70 CM
- 90 X 90 CM



LIGHTING LEDS

When we think about ecology and energy efficiency, LED lighting advantages are notorious, and LED technology is currently the most efficient lighting. The fact is that the LED is constructed from semiconductive material presenting considerable advantages regarding robustness, lifetime and reliability.

The brightness of mirrors and fixtures Bellian® with LED light stands out from other light sources, for its unparalleled brightness and the clarity of its light.

ÉCLAIRAGE LEDS

Quand on pense à l'écologie et efficacité énergétique, les avantages d'éclairage LED sont bien connus, la technologie LED est actuellement l'éclairage le plus efficace. LED est constitué de matériau semi-conducteur qui présente des avantages considérables en ce qui concerne la robustesse, la fiabilité et la durée de vie.

La luminosité des miroirs et appliques Bellian® avec lumière LED se distingue des autres sources lumineuses, pour sa luminosité inégalée et sa clarté.

ILUMINACIÓN LED

Cuando pensamos en la ecología y en la eficiencia energética, las ventajas de iluminación LED son notorias, la tecnología LED es actualmente la iluminación más eficiente. El hecho de que el LED está construido a partir de material semiconductor presentando ventajas considerables con respecto a la robustez, vida útil y fiabilidad.

El brillo de los espejos y apliques Bellian® con luz LED se destaca de otras fuentes de luz, por su brillo sin igual y la claridad de su luz.



LEDS

MIRROR WITH LEDS AND WATCH // MIROIR AVEC LEDS ET HORLOGE // ESPEJO CON LEDS Y RELOJ

60 X 65 CM

80 X 65 CM

100 X 65 CM



LEDS

MIRROR WITH LEDS // MIROIR AVEC LEDS // ESPEJO CON LEDS

60 X 65 CM

60 X 65 CM

WITH SENSOR
AVEC CAPTEUR
CON SENSOR

80 X 65 CM

80 CM X 65

WITH SENSOR
AVEC CAPTEUR
CON SENSOR

100 X 65 CM

100 X 65 CM

WITH SENSOR
AVEC CAPTEUR
CON SENSOR



SLEEK

MIRROR WITH LEDS // MIROIR AVEC LEDS // ESPEJO CON LEDS

60 X 60 CM

80 X 60 CM

100 X 60 CM

120 X 60 CM



COOL

MIRROR WITH LEDS // MIROIR AVEC LEDS // ESPEJO CON LEDS

60 X 60 CM

80 X 60 CM

100 X 60 CM

120 X 60 CM



MIRROR WITH FLUORESCENT LIGHTING
 MIROIR A/ ÉCLAIRAGE FLUORESCENT
 ESPEJO CON ILUMINACIÓN FLUORESCENTE



LIGHT H - IP44

MIRRORS // MIROIR // ESPEJO

60 X 60 CM	1X 8W
80 X 60 CM	1X 13W
100 X 60 CM	1X 21W
120 X 60 CM	1X 21W
140 X 60 CM	1X 21W



LIGHT V

MIRROR WITH DEFOGGER // MIROIR AVEC DÉSEMBUEUR // ESPEJO CON DESEMPAÑADOR

60 X 65 CM	2X 13W
80 X 65 CM	2X 13W
100 X 65 CM	2X 13W
120 X 65 CM	2X 13W



LIGHT H WHITE- IP 44

MIRRORS // MIROIR // ESPEJO

60 X 60 CM	WHITE	1X 8W
80 X 60 CM	BLANC	1X 13W
100 X 60 CM	BLANCO	1X 21W



ECO LIGHT H - IP20

MIRRORS // MIROIR // ESPEJO

60 X 50 CM	1X 8W
80 X 50 CM	1X 13W
100 X 50 CM	1X 21W
120 X 50 CM	1X 21W



LIGHT H

MIRROR WITH WATCH // MIROIR AVEC HORLOGE // ESPEJO CON RELOJ

60 X 60 CM	1X 8W
80 X 60 CM	1X 13W
100 X 60 CM	1X 13W



LIGHT H

MIRROR WITH MAGNIFYING // MIROIR AVEC GROSSISSANT // ESPEJO CON ESPEJO DE AUMENTO

60 X 60 CM	1X 8W
80 X 60 CM	1X 13W
100 X 60 CM	1X 21W



PREMIUM MIRROR WITH DECORATION
 MIROIR PREMIUM AVEC DÉCORATION
 ESPEJO CON DÉCORACIÓN

A GOLD
B SILVER

MIRRORS // MIROIR // ESPEJO

	GOLD	SILVER
60 X 70 CM		
70 X 70 CM		
80 X 70 CM		
100 X 70 CM		
120 X 70 CM		



A



B

A GOLD SCRATCHED
B SILVER SCRATCHED

MIRRORS // MIROIR // ESPEJO

	GOLD	SILVER
60 X 70 CM		
70 X 70 CM		
80 X 70 CM		
100 X 70 CM		
120 X 70 CM		



A



B

A SILVER BLACK
B SILVER SNOW

MIRRORS // MIROIR // ESPEJO

	BLACK	SNOW
60 X 70 CM		
70 X 70 CM		
80 X 70 CM		
100 X 70 CM		
120 X 70 CM		

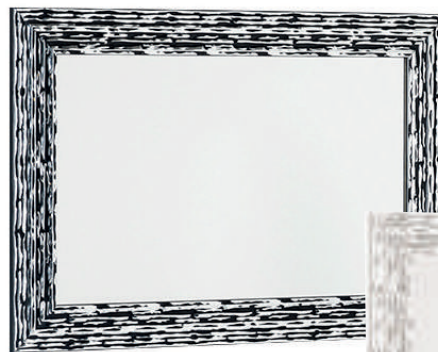

A



B

SIMPLE AND REVERSIBLE MIRROR
MIROIR SIMPLE ET REVERSIBLE
ESPEJOS SIMPLES Y REVERSIBLES



LISTA

MIRROR // MIROIR // ESPEJO

	 WHITE BLANC BLANCO	 BELLIAN COLOURS COULEURS BELLIAN COLORES BELLIAN	 RAL COLOURS COULEURS RAL COLORES RAL	 LEATHER CUIR CUERO
50 X 70 CM				
60 X 70 CM				
80 X 70 CM				
100 X 70 CM				
120 X 70 CM				



MOLDURA

MIRROR WITH FRAME // MIROIR AVEC CADRE // ESPEJO COM MARCO

	 WHITE BLANC BLANCO	 WENGE WENGE WENGER	 WHITE BLANC BLANCO	 WENGE WENGE WENGER
60 X 60 CM	WITHOUT LIGHT FIXTURE SANS APPLIQUE SEM APILIQUE		WITH BELL AVEC BELL CON BELL	
80 X 60 CM				
100 X 60 CM				



LISO

MIRROR WITH CHROMED FRAME // MIROIR AVEC CADRE CHROMÉ // ESPEJO COM MARCO CROMO

60 X 60 CM
80 X 60 CM
100 X 60 CM



LESS

REVERSIBLE MIRROR // MIROIR REVERSIBLE // ESPEJO REVERSIBLE

50 X 50 CM
60 X 50 CM
70 X 50 CM
80 X 50 CM
90 X 50 CM
100 X 50 CM
120 X 50 CM
140 X 50 CM
150 X 50 CM

LINEAL METRE
 METRE LINEARE
 METRO LINEAL



FIORE

REVERSIBLE MIRROR // MIROIR REVERSIBLE // ESPEJO REVERSIBLE

20 X 107 CM



SMART

REVERSIBLE MIRROR // MIROIR REVERSIBLE // ESPEJO REVERSIBLE

40 X 50 CM





INDY

ROUND MIRROR // MIRROR CIRCULAIRE // ESPEJO CIRCULAR

Ø35 CM

FROSTED MIRROR // DÉPOLISSAGE
MATEADO



DUBAI

ROUND MIRROR // MIRROR CIRCULAIRE // ESPEJO CIRCULAR

Ø60 CM

FROSTED MIRROR // DÉPOLISSAGE
MATEADO



PANAMÁ

REVERSIBLE MIRROR // MIROIR REVERSIBLE // ESPEJO REVERSIBLE

50 X 70 CM

FROSTED MIRROR // DÉPOLISSAGE
MATEADO



ARGENTINA

REVERSIBLE MIRROR // MIROIR REVERSIBLE // ESPEJO REVERSIBLE

60 X 80 CM

FROSTED MIRROR // DÉPOLISSAGE
MATEADO



ALEMANHA

REVERSIBLE MIRROR // MIROIR REVERSIBLE // ESPEJO REVERSIBLE

75 X 55CM

FROSTED MIRROR // DÉPOLISSAGE
MATEADO



ITÁLIA

REVERSIBLE MIRROR // MIROIR REVERSIBLE // ESPEJO REVERSIBLE

60 X 80 CM

FROSTED MIRROR // DÉPOLISSAGE
MATEADO



MACAU

REVERSIBLE MIRROR // MIROIR REVERSIBLE // ESPEJO REVERSIBLE

60 X 80 CM

FROSTED MIRROR // DÉPOLISSAGE
MATEADO



CUBA

REVERSIBLE MIRROR // MIROIR REVERSIBLE // ESPEJO REVERSIBLE

80 X 60 CM

FROSTED MIRROR // DÉPOLISSAGE
MATEADO

MIRROR CABINETS

ARMOIRES AVEC MIROIRS

ARMARIOS CON ESPEJOS

The perfect complement to storage at your bathroom space.

The range of Bellian® Mirror Cabinets combines practical storage and a mirror in a single object.

Le complément parfait pour stockage dans votre salle de bains.

La gamme d'armoires avec miroir Bellian® combine un rangement pratique et un miroir dans un seul objet.

El complemento perfecto para el almacenamiento en su espacio de baño.

La gama de armarios con espejo Bellian® combina un almacenamiento cómodo y un espejo en un solo objeto.



NORDIC

MIRROR CABINET WITH ROUNDED CORNERS

ARMOIRE DE TOILETTE AVEC COINS ARRONS // ARMARIO CON ESPEJOS CON ESQUINAS REDONDAS



60 X 60 CM 2 DOORS // 2 PORTES // 2 PUERTAS

80 X 60 CM 2 DOORS // 2 PORTES // 2 PUERTAS

100 X 60 CM 3 DOORS // 3 PORTES // 3 PUERTAS

120 X 60 CM 3 DOORS // 3 PORTES // 3 PUERTAS



PRACTICAL

MIRROR CABINET // ARMOIRE DE TOILETTE // ARMARIO CON ESPEJOS



60 X 60 CM 2 DOORS // 2 PORTES // 2 PUERTAS

80 X 60 CM 2 DOORS // 2 PORTES // 2 PUERTAS

100 X 60 CM 3 DOORS // 3 PORTES // 3 PUERTAS

120 X 60 CM 3 DOORS // 3 PORTES // 3 PUERTAS

LED LIGHT FIXTURES
APPLIQUES LED
APLIQUES LED

HALOGEN LIGHT FIXTURES
APPLIQUES HALOGENE
APLIQUES HALOGENO



LINE

LED LIGHT FIXTURE // APLIQUE LED // APLIQUE LED

LINE 28 CM 6 W

LINE II 50 CM 6 W

LINE 28 CM - W/ MULTI FITTING SUPPORT
A/ SUPPORT MULTI FIXATION // C/ APOYO MULTI-FIJACION 6 W

LINE II 50 CM - W/ MULTI FITTING SUPPORT
A/ SUPPORT MULTI FIXATION // C/ APOYO MULTI-FIJACION 6 W



SUN

LED LIGHT FIXTURE // APLIQUE LED // APLIQUE LED

Ø9 CM 6 W

Ø9 CM W/ MULTI FITTING SUPPORT
A/ SUPPORT MULTI FIXATION // C/ APOYO MULTI-FIJACION 6 W



CUBE M

HALOGEN LIGHT FIXTURE // APLIQUE HALOGENE // APLIQUE HALOGENO

10 X 10 CM MAX. 9W



LYRA

LED LIGHT FIXTURE // APLIQUE LED // APLIQUE LED

LYRA 28 CM 6 W

LYRA II 50 CM 6 W

LYRA 28 CM - W/ MULTI FITTING SUPPORT
A/ SUPPORT MULTI FIXATION // C/ APOYO MULTI-FIJACION 6 W

LYRA II 50 CM - W/ MULTI FITTING SUPPORT
A/ SUPPORT MULTI FIXATION // C/ APOYO MULTI-FIJACION 6 W



TRAFFIC

LED LIGHT FIXTURE // APLIQUE LED // APLIQUE LED

Ø9 CM 3.8 W

Ø9 CM W/ MULTI FITTING SUPPORT
A/ SUPPORT MULTI FIXATION // C/ APOYO MULTI-FIJACION 3.8 W

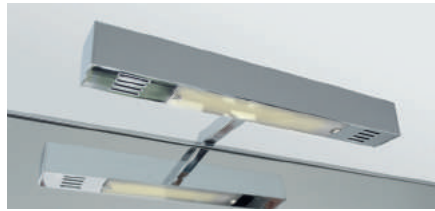

VERO

HALOGEN LIGHT FIXTURE // APLIQUE HALOGENE // APLIQUE HALOGENO

CROMADO 25,5 CM

MATE 25,5 CM

CROMADO 25,5 CM W/ MULTI FITTING SUPPORT
A/ SUPPORT MULTI FIXATION // C/ APOYO MULTI-FIJACION

MATE 25,5 CM W/ MULTI FITTING SUPPORT
A/ SUPPORT MULTI FIXATION // C/ APOYO MULTI-FIJACION



ALTAIR

LED LIGHT FIXTURE // APLIQUE LED // APLIQUE LED

35 CM 6 W



LEO

LED LIGHT FIXTURE // APLIQUE LED // APLIQUE LED

30 CM 3 W

30 CM W/ MULTI FITTING SUPPORT
A/ SUPPORT MULTI FIXATION // C/ APOYO MULTI-FIJACION 3 W



MULTI FITTING SUPPORT
SUPPORT MULTI-FIXATION
APOYO MULTI-FIJACION

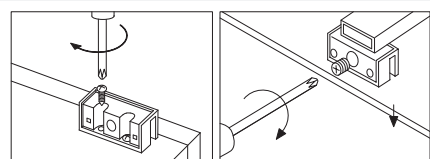

ACCESSORY - 1 UNIT
ACCESSOIRE - 1 UNITE
ACCESORIO - 1 UNIDAD



TUBE

HALOGEN LIGHT FIXTURE // APLIQUE HALOGENE // APLIQUE HALOGENO

23 CM 2 X 40 W

23 CM W/ MULTI FITTING SUPPORT
A/ SUPPORT MULTI FIXATION // C/ APOYO MULTI-FIJACION 2 X 40 W



BELL

HALOGEN LIGHT FIXTURE // APLIQUE HALOGENE // APLIQUE HALOGENO

5 X 5 CM MAX 40W

5 X 5 CM W/ MULTI FITTING SUPPORT
A/ SUPPORT MULTI FIXATION // C/ APOYO MULTI-FIJACION MAX 40W



ICE COLLECTION



CERAMIC COUNTERTOP WASHBASIN
PLAN VASQUE EN CÉRAMIQUE
LAVABO DE PORCELANA DE ENCIMERA



MODERN

CERAMIC COUNTERTOP WASHBASIN W/ 1 BOWL
PLAN VASQUE EN CÉRAMIQUE A/ 1 CUVE // LAVABO DE PORCELANA DE ENCIMERA C/ 1 PIA

61 X 46 CM

81 X 46 CM

101 X 46 CM

121 X 46 CM

WHITE
BLANC
BLANCO



MODERN DUO

CERAMIC COUNTERTOP WASHBASIN W/ 2 BOWLS
PLAN VASQUE EN CÉRAMIQUE A/ 2 CUVES // LAVABO DE PORCELANA DE ENCIMERA C/ 1 PIAS

121 X 46 CM

151 X 46 CM

WHITE
BLANC
BLANCO



ESFERA

CERAMIC COUNTERTOP WASHBASIN
PLAN VASQUE EN CÉRAMIQUE // LAVABO DE PORCELANA DE ENCIMERA

81 X 46 CM

101 X 46 CM

WHITE
BLANC
BLANCO



ONDA

CERAMIC COUNTERTOP WASHBASIN W/ 1 BOWL
PLAN VASQUE EN CÉRAMIQUE A/ 1 CUVE
LAVABO DE PORCELANA DE ENCIMERA C/ 1 PIA

61 X 46 CM

71 X 46 CM

81 X 46 CM

101 X 46 CM

WHITE
BLANC
BLANCO



SHORT

CERAMIC COUNTERTOP WASHBASIN
PLAN VASQUE EN CÉRAMIQUE // LAVABO DE PORCELANA DE ENCIMERA

51 X 39 CM

61 X 39 CM

81 X 39 CM

101 X 39 CM

WHITE
BLANC
BLANCO



FLUX

CERAMIC COUNTERTOP WASHBASIN
PLAN VASQUE EN CÉRAMIQUE // LAVABO DE PORCELANA DE ENCIMERA

61 X 46 CM

81 X 46 CM

101 X 46 CM

WHITE
BLANC
BLANCO



ONDA DUO

CERAMIC COUNTERTOP WASHBASIN W/ 2 BOWLS
PLAN VASQUE EN CÉRAMIQUE A/ 2 CUVES
LAVABO DE PORCELANA DE ENCIMERA C/ 1 PIAS

121 X 46 CM

WHITE
BLANC
BLANCO

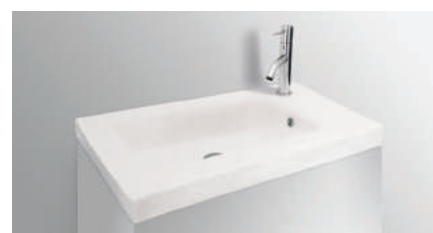

ZIP

CERAMIC COUNTERTOP WASHBASIN
PLAN VASQUE EN CÉRAMIQUE // LAVABO DE PORCELANA DE ENCIMERA

60 X 35 CM

80 X 35 CM

BRANCO

FOZ

CERAMIC BASIN

The FOZ washbasin stands out for contemporaneity of its lines, for cabinets with only 40 cm deep.

LAVABO CÉRAMIQUE

Le lavabo FOZ se distingue par la contemporanéité de ses lignes, pour meubles avec seulement 40 cm de profondeur.

LAVABO DE CERÁMICA

El lavabo FOZ se destaca por la contemporaneidad de sus líneas, para muebles con sólo 40 cm de profundidad.



FOZ

CERAMIC COUNTERTOP WASHBASIN
PLAN VASQUE EN CÉRAMIQUE
LAVABO DE PORCELANA DE ENCIMERA

51 X 39,5 CM
WHITE
BLANC
BLANCO



ICE

CAST MINERAL WASHBASIN
PLAN VASQUE MINÉRAL // LAVABO DE CARGA MINERAL

60 X 46 CM
80 X 46 CM
100 X 46 CM
WHITE
BLANC
BLANCO



ICE DUO

CAST MINERAL WASHBASIN
PLAN VASQUE MINÉRAL // LAVABO DE CARGA MINERAL

120 X 46 CM
WHITE
BLANC
BLANCO



SWEET

CAST MINERAL WASHBASIN
PLAN VASQUE MINÉRAL // LAVABO DE CARGA MINERAL

40 X 20 CM
WHITE
BLANC
BLANCO



NICE

CAST MINERAL WASHBASIN
PLAN VASQUE MINÉRAL // LAVABO DE CARGA MINERAL

40 X 22 CM
WHITE
BLANC
BLANCO

CAST MINERAL COUNTERTOP WASHBASIN
VASQUE À POSER EN CHARGE MINÉRALE
LAVABO DE CARGA MINERAL DE POSAR

MINERAL FILLER

The Bellian® washbasins in mineral filler have a unique look. The material used in the production results from a homogeneous mixture of different minerals, giving a design flexibility that goes beyond all the possibilities that traditional materials allows.

CHARGE MINÉRALE

Les lavabos Bellian® en charge minérale ont un look unique. Le matériau utilisé dans sa production résulte à partir d'un mélange homogène de différents minéraux, donnant une flexibilité de conception qui va au-delà de toutes les possibilités que les matériaux traditionnels permettent.

CARGA MINERAL

Los lavabos Bellian® en carga mineral tienen un estilo único. El material utilizado en su producción resulta de una mezcla homogénea de diferentes minerales, dando una flexibilidad de diseño que trasciende todas las posibilidades de los materiales tradicionales.

SNOW

CAST MINERAL COUNTERTOP WASHBASIN
VASQUE À POSER EN CHARGE MINÉRAL // LAVABO DE CARGA MINERAL DE POSAR

45 X 40 CM
WHITE
BLANC
BLANCO





CERAMIC COUNTERTOP WASHBASIN
VASQUE EN CÉRAMIQUE À POSER
LAVABO DE PORCELANA DE POSAR



COTTON

CERAMIC COUNTERTOP WASHBASIN // VASQUE À POSER EN CÉRAMIQUE // LAVABO DE PORCELANA DE POSAR

Ø39 CM

WHITE
BLANC
BLANCO



CLOUD

CERAMIC COUNTERTOP WASHBASIN // VASQUE À POSER EN CÉRAMIQUE // LAVABO DE PORCELANA DE POSAR

48 CM

WHITE
BLANC
BLANCO



NEPAL

CERAMIC COUNTERTOP WASHBASIN // VASQUE À POSER EN CÉRAMIQUE // LAVABO DE PORCELANA DE POSAR

63 X 43 CM

WHITE
BLANC
BLANCO



EVEREST

CERAMIC COUNTERTOP WASHBASIN // VASQUE À POSER EN CÉRAMIQUE // LAVABO DE PORCELANA DE POSAR

64 X 40 CM

WHITE
BLANC
BLANCO



MISTIC

CERAMIC COUNTERTOP WASHBASIN // VASQUE À POSER EN CÉRAMIQUE // LAVABO DE PORCELANA DE POSAR

40 X 40 CM

WHITE
BLANC
BLANCO



CANYON

CERAMIC COUNTERTOP WASHBASIN // VASQUE À POSER EN CÉRAMIQUE // LAVABO DE PORCELANA DE POSAR

40 X 40 CM

WHITE
BLANC
BLANCO



FROST

CERAMIC COUNTERTOP WASHBASIN // VASQUE À POSER EN CÉRAMIQUE // LAVABO DE PORCELANA DE POSAR

49 X 39 CM

WHITE
BLANC
BLANCO



POLAR

CERAMIC COUNTERTOP WASHBASIN // VASQUE À POSER EN CÉRAMIQUE // LAVABO DE PORCELANA DE POSAR

Ø46 CM

WHITE
BLANC
BLANCO

CERAMIC COUNTERTOP WASHBASIN
 VASQUE EN CÉRAMIQUE À POSER
 LAVABO DE PORCELANA DE POSAR



ICEBERG

CERAMIC COUNTERTOP WASHBASIN // VASQUE À POSER EN CÉRAMIQUE // LAVABO DE PORCELANA DE POSAR

Ø42 CM

WHITE
 BLANC
 BLANCO



GLACIAR

CERAMIC COUNTERTOP WASHBASIN // VASQUE À POSER EN CÉRAMIQUE // LAVABO DE PORCELANA DE POSAR

Ø45 CM

WHITE
 BLANC
 BLANCO



ÁRTICO

CERAMIC COUNTERTOP WASHBASIN // VASQUE À POSER EN CÉRAMIQUE // LAVABO DE PORCELANA DE POSAR

45 X 31 CM

WHITE
 BLANC
 BLANCO



FRESH

CERAMIC COUNTERTOP WASHBASIN // VASQUE À POSER EN CÉRAMIQUE // LAVABO DE PORCELANA DE POSAR

52 X 36,5 CM

WHITE
 BLANC
 BLANCO



FREEZE

CERAMIC COUNTERTOP WASHBASIN // VASQUE À POSER EN CÉRAMIQUE // LAVABO DE PORCELANA DE POSAR

38 X 38 CM

WHITE
 BLANC
 BLANCO



FREEZE

CERAMIC COUNTERTOP WASHBASIN // VASQUE À POSER EN CÉRAMIQUE // LAVABO DE PORCELANA DE POSAR

47 X 47 CM

WHITE
 BLANC
 BLANCO



LYNX

CERAMIC COUNTERTOP WASHBASIN // VASQUE À POSER EN CÉRAMIQUE // LAVABO DE PORCELANA DE POSAR

60 X 45 CM

WHITE
 BLANC
 BLANCO

**KNOW ALL
 THE LYNX SANITARY WARE RANGE**

**DÉCOUVREZ
 TOUTE LA GAMME D'APPAREILS SANITAIRES LYNX**

**CONOZCA
 TODA LA GAMA DE SANITARIOS LYNX**

NA PÁGINA 232





CERAMIC SEMI RECESSED WASHBASIN
 VASQUE SEMI-ENCASTRÉ EN CÉRAMIQUE
 LAVABO DE PORCELANA SEMIENCASTRADO



ALPES

CERAMIC SEMI RECESSED WASHBASIN
 VASQUE SEMI-ENCASTRÉ EN CÉRAMIQUE // LAVABO DE PORCELANA SEMIENCASTRADO

59 X 40 CM

WHITE
 BLANC
 BLANCO

CERAMIC UNDERCOUNTER WASHBASIN
 LAVABO SOUS LE COMPTOIR EN CÉRAMIQUE
 LAVABO DE PORCELANA DE BAJO ENCIMERA



CERAMIC UNDERCOUNTER WASHBASIN
 LAVABO SOUS LE PLAN EN CÉRAMIQUE
 LAVABO DE PORCELANA BAJO ENCIMERA

54 X 34 CM

WHITE
 BLANC
 BLANCO

STONE COUNTERTOP
 PLAN DE TOILETTE EN PIERRE
 TAMPO DE PIEDRA



WHITE MICRO
 BLANC MICRO
 BLANCO MICRO



MARFIL
 MARFIL
 MARFIL

61

71

81

101



STONE COUNTERTOP
 PLAN DE TOILETTE EN PIERRE
 TAMPO DE PIEDRA



WHITE MICRO
 BLANC MICRO
 BLANCO MICRO



MARFIL
 MARFIL
 MARFIL

61

81

101

121

LINEAL METRE
 MÈTRE LINÉAIRE
 METRO LINEAL



WHAT'S YOUR FAVORITE COLOUR?

The Bellian® environment is designed for contemporary living. The space of your bathroom is a unique space and as such deserves a personalized touch. The Bellian® allows you the choice of any RAL color applied to any basin or glass top..

QUELLE EST VOTRE COULEUR PRÉFÉRÉE?

L'environnement Bellian® est conçu pour la vie contemporaine. L'espace de votre salle de bain est un espace unique et mérite donc une touche personnalisée. Bellian® vous permet choisir quelque la couleur RAL appliquée à toutes les vasques en verre.

¿CUAL ES TU COLOR FAVORITO?

Los ambientes Bellian® están diseñados para la vida contemporánea. El espacio de su cuarto de baño es un espacio único, y por lo tanto merece un toque personalizado. Bellian® permite elegir cualquier color RAL aplicada a cualquier lavabo o tapa de vidrio.

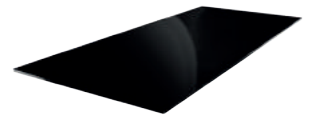

VIDRO

GLASS COUNTERTOP WASHBASIN
PLAN VASQUE EN VERRE
LAVABO DE CRISTAL DE ENCIMERA

	BELLIAN COLOURS COULEURS BELLIAN COLORES BELLIAN	RAL COLOURS COULEURS RAL COLORES RAL
61		
81		
101		
121 1 PIA		
121 2 PIAS		
LINEAL METRE MÈTRE LINÉAIRE METRO LINEAL		

FLUX

GLASS COUNTERTOP WASHBASIN
PLAN VASQUE EN VERRE
LAVABO DE CRISTAL DE ENCIMERA

	BELLIAN COLOURS COULEURS BELLIAN COLORES BELLIAN	RAL COLOURS COULEURS RAL COLORES RAL
61		
81		
101		
121 1 PIA		
121 2 PIAS		
LINEAL METRE MÈTRE LINÉAIRE METRO LINEAL		

ESFERA

GLASS COUNTERTOP WASHBASIN
PLAN VASQUE EN VERRE
LAVABO DE CRISTAL DE ENCIMERA

	BELLIAN COLOURS COULEURS BELLIAN COLORES BELLIAN	RAL COLOURS COULEURS RAL COLORES RAL
61		
81		
101		
121 1 PIA		
121 2 PIAS		
LINEAL METRE MÈTRE LINÉAIRE METRO LINEAL		

TAMPO

GLASS COUNTERTOP WASHBASIN
PLAN DE TOILETTE EN VERRE
TAMPO DE CRISTAL

	BELLIAN COLOURS COULEURS BELLIAN COLORES BELLIAN	RAL COLOURS COULEURS RAL COLORES RAL
61		
81		
101		
121 1 PIA		
121 2 PIAS		
LINEAL METRE MÈTRE LINÉAIRE METRO LINEAL		

SMART

The SMART glass countertop washbasins are exclusive to reduced depth SMART, PETTY and SMALL base unit.

Les vasques SMART sont exclusives des modèles de meubles SMART, PETTY and SMALL pour profondeurs réduites.

Los lavabos SMART son exclusivos de los muebles SMART, PETTY and SMALL, o para otros de profundidad reducida.



SMART

MINI GLASS COUNTERTOP WASHBASIN
PLAN VASQUE EN VERRE MINI
LAVABO DE CRISTAL DE ENCIMERA MINI

WHITE OXIDE BLANC OXYDE BLANCO OXIDO	BLACK NOIR NEGRO	GOLDEN DORÉ DORADO

40

HOLE GLASS OR STONE COUNTERTOP

FORAGE PLAN DE TOILETTE EN VERRE OU PIERRE

PERFORACIÓN TAMPO CRISTAL O PIEDRA

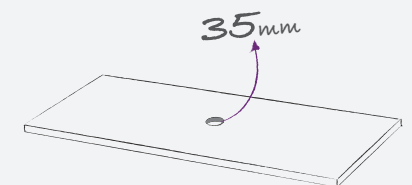

HOLE // TROU // AGUJERO

Ø35MM (UNIT // UNITÉ // UNIDADE)

GLASS CUSTOM PRINTING

Each Bellian® piece assumes its own identity, a soul in your bathroom space and a new element in your life that evokes emotions and unique sensations. With digital printing technique on glass, Bellian® gives you endless options to decorate and colour shower or bath enclosure where the limits are your imagination. Select a image that reflects your style and give your bathroom space a unique personality.

Get inspired in the examples that we show and make a good impression...

INSPIRATIONS // INSPIRATIONS // INSPIRACIONES



VECTOR ILLUSTRATIONS
ILLUSTRATIONS VECTORIELLES
ILUSTRACIONES DE VECTORES



TEXTURES
TEXTURES
TEXTURAS



PATTERNS
MOTIFS
PATRONES

VERRE CUSTOM IMPRESSION

Chaque pièce Bellian® assume son identité, une âme dans votre espace de salle de bains et un nouvel élément dans sa vie que évoque des émotions et des sensations uniques. Avec une technique d'impression digitale dans le verre, Bellian® vous donne des options illimitées pour décorer avec des couleurs et des images votre PAROIS de douche ou baignoire où les limites sont les de votre imagination.

Sélectionnez l'image qui reflète votre style et donnez à votre espace de bains votre personnalité unique.

Laissez-vous inspirer dans les exemples qui nous vous montrent et impressionnez...



ACABAMENTO ESPELHADO // ACABAMENTO ESPELHADO // ACABADO DE ESPEJO

MIRROR FINISHING

You can also choose our mirror finishing for your shower enclosure to better reflect your bathroom concept.

This finish not only proves very useful but also offers an optimal solution to maximize your shower space.

FINITION DE MIROIR

Vous pouvez aussi choisir mieux refléter votre image dans votre PAROIS de douche, choisissez la finition de miroir que nous mettons à votre disposition. Cette finition au-delà de se révéler très utile, est une solution optimale pour maximiser votre espace de douche.

ACABADO DE ESPEJO

También puede elegir nuestro acabado de espejo para su mampara de ducha para mejor reflejar su espacio de baño.

Este acabado no sólo ha demostrado ser muy útil, pero también ofrece una solución óptima para maximizar su espacio de baño.

VIDRIO IMPRESIÓN PERSONALIZADA

Cada pieza Bellian® asume su propia identidad, un alma en su espacio de baño y un nuevo elemento en su vida que evoca emociones y sensaciones únicas. Con la técnica de impresión digital sobre vidrio, Bellian® le ofrece un sinfín de opciones para decorar y colorear su mampara de baño donde el único límite es su imaginación.

Seleccione una imagen que refleje su estilo para darle a su espacio de baño una personalidad única.



1ST YOUR CHILD'S DRAWING
1^{ER} DESSIN DE VOTRE ENFANT
1º DIBUJO DE SU HIJO



FAMILY MASCOT
FAMILLE MASCOT
MASCOTA DE LA FAMILIA



PHOTOGRAPHY OF A JOURNEY
PHOTOGRAPHIE D'UNE PROMENADE
FOTOGRAFÍA DE UN VIAJE

FINISHES // FINITIONS // ACABADOS

GLASS // VERRE // VIDRIO



TRANSPARENT
TRANSPARENT
TRANSPARENTE



SERIGRAPHED
SERIGRAPHIE
SERIGRAFIADO

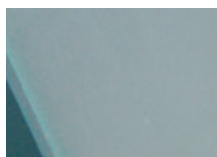

FOGGED
DÉPOLI
FOSCO

FRAME // PROFIL // PERFILE

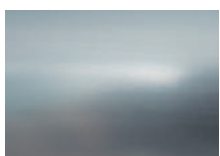

METALLIC
METALLIQUE
METÁLICO



CHROMED
CHROMÉ
CROMO



WHITE
BLANC
BLANCO



BRUSHED STAINLESS STEEL
INOX BROSSÉ
ACERO INOXIDABLE CEPILLADO



POLISHED STAINLESS STEEL
INOX POLI
ACERO INOXIDABLE PULIDO



bellian®
SHOWER ENCLOSURES
CABINES DE DOUCHE
MAMPARAS DE DUCHA

Continuously monitors trends in design, Bellian® has a wide range of solutions for bathroom spaces. The obsession with quality is incorporated in solutions where functionality is preponderant: aesthetics and comfort take many forms to meet all the requirements of a personalized environment.

Transparent tempered glass, frosted or screen are applied in aluminum or stainless steel profiles with a glossy finish, resulting mat or white in a unique aesthetic lightness.

Suit en permanence les tendances du design, Bellian® dispose d'une large gamme de solutions pour la salle de bains.

L'obsession avec la qualité est incorporée dans les solutions où la fonctionnalité est prépondérante: esthétique et confort prennent de nombreuses formes pour répondre à toutes les exigences d'un environnement personnalisé.

Verre trempé transparent, dépoli ou sérigraphié est appliqué dans les profils en aluminium ou en acier inoxydable avec une finition brillante, mate ou blanc résultant en une légèreté esthétique unique.

Estamos continuamente siguiendo las tendencias del design y la innovación de los materiales y tecnologías, Bellian® ofrece una amplia gama de soluciones para su espacio de ducha. La obsesión por la calidad se materializa en soluciones donde la funcionalidad es predominante. La estética y la comodidad toman muchas formas para cumplir con todos los requisitos de un ambiente personalizado.

Vidrio templado transparente, mate o serigrafiado se aplican en perfiles de aluminio o de acero inoxidable con acabado brillante, mate o blanco, de que resulta una ligereza estética única.

101-120CM



SHOWER ENCLOSURE WITH 1 SLIDING DOOR + 1 FIXED PANEL | FOGGED GLASS AND BRUSHED STAINLESS STEEL ACCESSORIES
 PAROIS DE DOUCHE 1 PORTE COULISSANTE + 1 PANNEAU FIXE | VERRE DÉPOLI ET ACCESSOIRES DE FIXATION EN ACIER INOXYDABLE BROSSÉ
 MAMPARA DE DUCHA CON 1 PUERTA CORREDERA + 1 PANEL FIJO | VIDRIO FOSCO Y ACCESORIOS EN ACERO INOXYDABLE CEPILLADO

3 TYPES HANDLE POIGNÉE TIRADORES



SQUARE HANDLE
 POIGNÉE CARRÉE
 TIRADOR REDONDA



ROUND HANDLE
 POIGNÉE RONDE
 TIRADOR CUADRADO



WING HANDLE
 POIGNÉE ASA
 TIRADOR ALA



SLIDING DOOR
 PORTE COULISSANTE
 PUERTA CORREDERA

SHOWER ENCLOSURE W/ 1 SLIDING DOOR + 1 FIXED PANEL
 PAROIS DE DOUCHE A/ 1 PORTE COULISSANTE + 1 PANNEAU FIXE
 MAMPARA DE DUCHA C/ 1 PUERTA CORREDERA + 1 PANEL FIJO

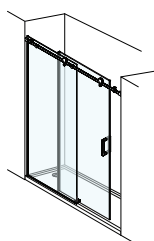

MEASUREMENTS MEDIDAS	FRAME PROFIL PERFILE	TRANSPARENT TRANSPARENT	SERIGRAPHED SERIGRAFADO	FOGGED DÉPOLI FOSCO
80 - 100 CM	BRUSHED POLISHED BROSSE POLI CEPILLADO PULIDO			
101 - 120 CM	BRUSHED POLISHED BROSSE POLI CEPILLADO PULIDO			
121 - 140 CM	BRUSHED POLISHED BROSSE POLI CEPILLADO PULIDO			
141 - 160 CM	BRUSHED POLISHED BROSSE POLI CEPILLADO PULIDO			
161 - 180 CM	BRUSHED POLISHED BROSSE POLI CEPILLADO PULIDO			

DOOR WITH A MAXIMUM WIDTH OF 80 CM
 PORTE AU MAXIMUM LARGEUR 80 CM
 PUERTA CON UNA ANCHURA MÁXIMA DE 80 CM

SHOWER ENCLOSURE W/ 2 SLIDING DOORS + 2 FIXED PANELS
 PAROIS DE DOUCHE A/ 2 PORTES COULISSANTES + 2 PANNEAUX FIXES
 MAMPARA DE DUCHA C/ 2 PUERTAS CORREDERAS + 2 PANELES FIJOS



MEASUREMENTS MEDIDAS	FRAME PROFIL PERFILE	TRANSPARENT TRANSPARENT	SERIGRAPHED SERIGRAFADO	FOGGED DÉPOLI FOSCO
140 - 160 CM	BRUSHED POLISHED BROSSE POLI CEPILLADO PULIDO			
161 - 180 CM	BRUSHED POLISHED BROSSE POLI CEPILLADO PULIDO			
181 - 200 CM	BRUSHED POLISHED BROSSE POLI CEPILLADO PULIDO			
201 - 220 CM	BRUSHED POLISHED BROSSE POLI CEPILLADO PULIDO			
221 - 240 CM	BRUSHED POLISHED BROSSE POLI CEPILLADO PULIDO			

DOOR WITH A MAXIMUM WIDTH OF 60 CM
 PORTE AU MAXIMUM LARGEUR 60 CM
 PUERTA CON UNA ANCHURA MÁXIMA DE 60 CM

140-160CM



SHOWER ENCLOSURE WITH 2 SLIDING DOOR W/ MAGNETIC CLOSE + 2 FIXED PANELS
TRANSPARENT GLASS AND POLISHED STAINLESS STEEL ACCESSORIES
 PAROIS DE DOUCHE 2 PORTES COULISSANTES + 2 PANNEAUX FIXES
 VERRE TRANSPARENT ET ACCESSOIRES DE FIXATION EN ACIER INOXYDABLE POLI
 MAMPARA DE DUCHA CON 2 PUERTAS CORREDIZAS + 2 PANELES FIJOS
 VIDRIO FOSCO Y ACCESORIOS EN ACERO INOXYDABLE PULIDO

181 x 200 CM



SHOWER ENCLOSURE WITH 1 SLIDING DOOR + 1 FIXED PANEL + 1 SIDE PANEL
TRANSPARENT GLASS AND POLISHED STAINLESS STEEL ACCESSORIES
 PAROIS DE DOUCHE 1 PORTE COULISSANTE + 1 PANNEAU FIXE + 1 PANNEAU LATÉRAL
 VERRE TRANSPARENT ET ACCESSOIRES DE FIXATION EN ACIER INOXYDABLE POLI
 MAMPARA DE DUCHA CON 1 PUERTA CORREDERA + 1 PANEL FIJO + 1 PANEL LATÉRAL
 VIDRIO FOSCO Y ACCESORIOS EN ACERO INOXYDABLE PULIDO

SHOWER ENCLOSURE W/ 1 SLIDING DOOR + 1 FIXED PANEL + 1 SIDE PANEL
 PAROIS DE DOUCHE A/ 1 PORTE COULISSANTE + 1 PANNEAU FIXE + 1 P. LATÉRAL
 MAMPARA DE DUCHA C/ 1 PUERTA CORREDERA + 1 PANEL FIJO + 1 P. LATÉRAL

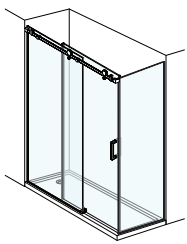

MEASUREMENTS MESURES MEDIDAS	FRAME PROFIL PERFILE	TRANSPARENT TRANSPARENT TRANSPARENTE	SERIGRAPHED FOGGED SERIGRAPHÉ DÉPOLI SERIGRAFADO FOSCO
160 - 180 CM	BRUSHED POLISHED BROSSE POLI CEPILLADO PULIDO		
181 - 200 CM	BRUSHED POLISHED BROSSE POLI CEPILLADO PULIDO		
201 - 220 CM	BRUSHED POLISHED BROSSE POLI CEPILLADO PULIDO		
221 - 240 CM	BRUSHED POLISHED BROSSE POLI CEPILLADO PULIDO		

DOOR WITH A MAXIMUM WIDTH OF 80 CM
 PORTE AU MAXIMUM LARGEUR 80 CM
 PUERTA CON UNA ANCHURA MÁXIMA DE 80 CM

SHOWER ENCLOSURE W/ 1 SLIDING DOOR + 1 FIXED PANEL + 2 SIDE PANELS
 PAROIS DE DOUCHE A/ 1 PORTE COULISSANTE + 1 PANNEAU FIXE + 2 P. LATÉRAUX
 MAMPARA DE DUCHA C/ 1 PUERTA CORREDERA + 1 P. FIJO + 1 P. LATÉRALES



MEASUREMENTS MESURES MEDIDAS	FRAME PROFIL PERFILE	TRANSPARENT TRANSPARENT TRANSPARENTE	SERIGRAPHED FOGGED SERIGRAPHÉ DÉPOLI SERIGRAFADO FOSCO
220 - 240 CM	BRUSHED POLISHED BROSSE POLI CEPILLADO PULIDO		
241 - 260 CM	BRUSHED POLISHED BROSSE POLI CEPILLADO PULIDO		
261 - 280 CM	BRUSHED POLISHED BROSSE POLI CEPILLADO PULIDO		
281 - 300 CM	BRUSHED POLISHED BROSSE POLI CEPILLADO PULIDO		
301 - 320 CM	BRUSHED POLISHED BROSSE POLI CEPILLADO PULIDO		

DOOR WITH A MAXIMUM WIDTH OF 80 CM
 PORTE AU MAXIMUM LARGEUR 80 CM
 PUERTA CON UNA ANCHURA MÁXIMA DE 80 CM

Bath or shower enclosures in transparent, serigraphed or fogged tempered glass 8mm. Fittings in polished or brushed stainless steel and magnetic closure doors. The sliding door system allows a wide access to the bathroom space. Height 200 cm.

Parois de douche ou baignoire en verre trempé de 8mm, transparent, sérigraphié ou dépoli. Accessoires de fixation en inox poli ou brossé et fermeture magnétique entre les ports. Le système de portes coulissantes permet un large accès à l'espace de bains. Hauteur 200 cm.

Mampara de ducha o baño en vidrio templado de 8 mm, transparente, serigrafado o mate. Accesorios en acero inoxidable pulido o cepillado y cierre magnético entre las puertas. El sistema de puertas correderas permite un amplio acceso al espacio de baño. Altura: 200 cm.

SHOWER ENCLOSURE W/ 2 SLIDING DOORS + 2 FIXED PANELS
 PAROIS DE DOUCHE A/ 2 PORTES COULISSANTES + 2 PANNEAUX FIXES
 MAMPARA DE DUCHA C/ 2 PUERTAS CORREDERAS + 1 PANELES FIJOS

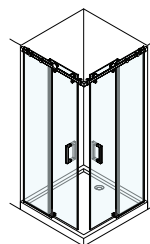

MEASUREMENTS MESURES MEDIDAS	FRAME PROFIL PERFILE	TRANSPARENT TRANSPARENT TRANSPARENTE	SERIGRAPHED FOGGED SERIGRAPHÉ DÉPOLI SERIGRAFADO FOSCO
140 - 160 CM	BRUSHED POLISHED BROSSE POLI CEPILLADO PULIDO		
161 - 180 CM	BRUSHED POLISHED BROSSE POLI CEPILLADO PULIDO		
181 - 200 CM	BRUSHED POLISHED BROSSE POLI CEPILLADO PULIDO		

DOOR WITH A MAXIMUM WIDTH OF 50 CM
 PORTE AU MAXIMUM LARGEUR 50 CM
 PUERTA CON UNA ANCHURA MÁXIMA DE 50 CM

WHEN ORDERING MUST FILL THE DOCUMENT FOR THE CORRECT IDENTIFICATION OF ALL MEASURES AND FEATURES INTENDED.
 A LA COMMANDE REMPLIR LE FORMULAIRE DE COMMANDE AVEC L'IDENTIFICATION CORRECTE DE TOUTES LES MESURES ET CARACTÉRISTIQUES.
 EN EL PEDIDO COMPLETE LA FORMA DE ORDEN CON LA IDENTIFICACIÓN ADECUADA DE TODAS LAS MEDIDAS Y CARACTERÍSTICAS.

200-220CM



BATH ENCLOSURE WITH 1 SLIDING DOOR + 1 FIXED PANEL + 1 SIDE PANEL | TRANSPARENT GLASS AND POLISHED STAINLESS STEEL ACCESSORIES
 PARE-BAIGNOIRE A/ 1 PORTE COULISSANTE + 1 PANNEAU FIXE + 1 PANNEAU LATÉRAL | VERRE TRANSPARENT ET ACCESSOIRES DE FIXATION EN ACIER INOXYDABLE POLI
 MAMPARA DE BAÑO CON 1 PUERTA CORREDERA + 1 PANEL FIJO + 1 PANEL LATÉRAL | VIDRIO TRANSPARENT Y ACCESORIOS EN ACERO INOXYDABLE PULIDO

BATH ENCLOSURE W/ 1 SLIDING DOOR + 1 FIXED PANEL + 1 SIDE PANEL
 PARE-BAIGNOIRE A/ 1 PORTE COULISSANTE + 1 PANNEAU FIXE + 1 PANNEAU LATÉRAL
 MAMPARA DE BAÑO C/ 1 PUERTA CORREDERA + 1 PANEL FIJO + 1 P. LATÉRAL

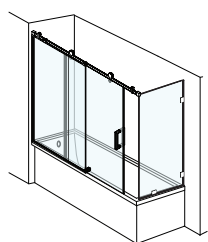

MEASUREMENTS MESURES MEDIDAS	FRAME PROFIL PERFILE	TRANSPARENT TRANSPARENT TRANSPARENTE	SERIGRAPHED FOGGED SERIGRAPHÉ DÉPOLI SERIGRAFADO FOSCO
200 - 220 CM	BRUSHED POLISHED BROSSE POLI CEPILLADO PULIDO		
221 - 240 CM	BRUSHED POLISHED BROSSE POLI CEPILLADO PULIDO		
241 - 260 CM	BRUSHED POLISHED BROSSE POLI CEPILLADO PULIDO		

BATH ENCLOSURE W/ 1 SLIDING DOOR + 1 FIXED PANEL
 PARE-BAIGNOIRE A/ 1 PORTE COULISSANTE + 1 PANNEAU FIXE
 MAMPARA DE BAÑO C/ 1 PUERTA CORREDERA + 1 PANEL FIJO

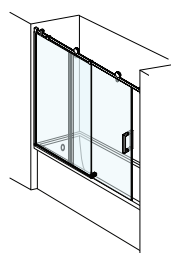

MEASUREMENTS MESURES MEDIDAS	FRAME PROFIL PERFILE	TRANSPARENT TRANSPARENT TRANSPARENTE	SERIGRAPHED FOGGED SERIGRAPHÉ DÉPOLI SERIGRAFADO FOSCO
140 - 160 CM	BRUSHED POLISHED BROSSE POLI CEPILLADO PULIDO		
161 - 180 CM	BRUSHED POLISHED BROSSE POLI CEPILLADO PULIDO		

BATH ENCLOSURE W/ 1 SLIDING DOOR + 1 FIXED PANEL + 2 SIDE PANEL
 PARE-BAIGNOIRE A/ 1 PORTE COULISSANTE + 1 PANNEAU FIXE + 2 P. LATÉRALAUX
 MAMPARA DE BAÑO C/ 1 PUERTA CORREDERA + 1 PANEL FIJO + 2 PANELES LATÉRALES

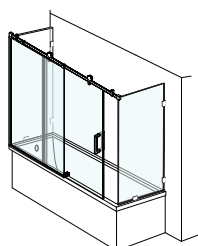

MEASUREMENTS MESURES MEDIDAS	FRAME PROFIL PERFILE	TRANSPARENT TRANSPARENT TRANSPARENTE	SERIGRAPHED FOGGED SERIGRAPHÉ DÉPOLI SERIGRAFADO FOSCO
260 - 280 CM	BRUSHED POLISHED BROSSE POLI CEPILLADO PULIDO		
281 - 300 CM	BRUSHED POLISHED BROSSE POLI CEPILLADO PULIDO		
301 - 320 CM	BRUSHED POLISHED BROSSE POLI CEPILLADO PULIDO		
321 - 340 CM	BRUSHED POLISHED BROSSE POLI CEPILLADO PULIDO		

BATH ENCLOSURE W/ 2 SLIDING DOORS + 2 FIXED PANELS
 PARE-BAIGNOIRE A/ 2 PORTES COLISSANTES + 2 PANNEAUX FIXES
 MAMPARA DE BAÑO C/ 2 PUERTAS CORREDERAS + 2 PANELES FIJOS

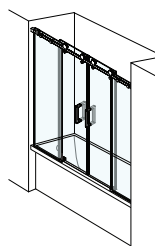

MEASUREMENTS MESURES MEDIDAS	FRAME PROFIL PERFILE	TRANSPARENT TRANSPARENT TRANSPARENTE	SERIGRAPHED FOGGED SERIGRAPHÉ DÉPOLI SERIGRAFADO FOSCO
140 - 160 CM	BRUSHED POLISHED BROSSE POLI CEPILLADO PULIDO		
161 - 180 CM	BRUSHED POLISHED BROSSE POLI CEPILLADO PULIDO		



SHOWER ENCLOSURE WITH 1 FOLDING DOOR + 1 FIXED PANEL | TRANSPARENT GLASS
 PAROIS DE DOUCHE 1 PORTE PLIANTE + 1 PANNEAU FIXE | VERRE TRANSPARENT
 MAMPARA DE DUCHA CON 1 PUERTA PLEGABLE + 1 PANEL FIJO | VIDRIO TRANSPARENT

SHOWER ENCLOSURE W/ 1 FOLDING DOOR + 1 FIXED PANEL
 PAROIS DE DOUCHE A/ 1 PORTE PLIANTE + 1 PANNEAU FIXE
 MAMPARA DE DUCHA C/ 1 PUERTA PLEGABLE + 1 PANEL FIJO

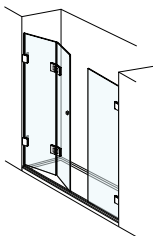

MEASUREMENTS MESURES MEDIDAS	TRANSPARENT TRANSPARENT TRANSPARENTE	SERIGRAPHED FOGGED SERIGRAPHÉ DÉPOLI SERIGRAFADO FOSCO
100 - 120 CM		
121 - 140 CM		
141 - 160 CM		
161 - 180 CM		
181 - 200 CM		

SHOWER ENCLOSURE W/ 1 FOLDING DOOR
 PAROIS DE DOUCHE A/ 1 PORTE PLIANTE
 MAMPARA DE DUCHA C/ 1 PUERTA PLEGABLE

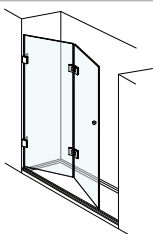

MEASUREMENTS MESURES MEDIDAS	TRANSPARENT TRANSPARENT TRANSPARENTE	SERIGRAPHED FOGGED SERIGRAPHÉ DÉPOLI SERIGRAFADO FOSCO
40 - 60 CM		
61 - 80 CM		
81 - 100 CM		
101 - 120 CM		



HINGES DESIGNED FOR SEALING AT 100%
 CHARNIÈRES CONÇUS POUR ASSURER L'ÉTANCHÉITÉ À 100%
 BISAGRAS DISEÑADAS PARA EL SELLADO A 100%

bellian
8mm CRIMP

PERFECT SHOWER
BROAD ACCESS AND OPTIMUM SEALING

Shower enclosures in tempered glass 8 mm, transparent, serigraphed or fogged for free access to the shower that stand out for their minimalist aesthetic. Equipped with hinges in chromed brass with a special configuration incorporating the seal inside wich in combination with magnetic closure allows you to optimize the tightness and improve comfort in your shower. Height 200 cm.

DOUCHE PARFAIT
LARGE ACCÈS ET ÉTANCHÉITÉ OPTIMALE

Parois de douche en verre trempé 8 mm, transparent, sérigraphié ou dépoli de libre accès à la douche qui se distinguent par leur esthétique minimaliste. Equipé de charnières en laiton chromé avec une configuration spéciale incorporant le joint d'étanchéité à l'intérieur et que par sa fermeture magnétique permet d'optimiser l'étanchéité et améliorer le confort dans votre douche. Hauteur 200 cm.

PERFECTA DUCHA
AMPLIO ACCESO Y ÓPTIMO SELLADO

Mamparas de ducha en vidrio templado de 8 mm, transparente, serigrafado o mate de libre acceso a la ducha que se destacan por su estética minimalista. Equipado con bisagras en latón cromado con una configuración especial que incorpora la junta en el interior y que con el cierre magnético le permite optimizar la estanqueidad y mejorar el confort en la ducha. Altura: 200 cm.

SHOWER ENCLOSURE W/ 2 FOLDING DOOR S
 PAROIS DE DOUCHE A/ 2 PORTES PLIANTES
 MAMPARA DE DUCHA C/ 2 PUERTAS PLEGABLES

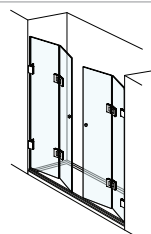

MEASUREMENTS MESURES MEDIDAS	TRANSPARENT TRANSPARENT TRANSPARENTE	SERIGRAPHED FOGGED SERIGRAPHÉ DÉPOLI SERIGRAFADO FOSCO
120 - 140 CM		
141 - 160 CM		
161 - 180 CM		
181 - 200 CM		
201 - 220 CM		

WHEN ORDERING MUST FILL THE DOCUMENT FOR THE CORRECT IDENTIFICATION OF ALL MEASURES AND FEATURES INTENDED.
 A LA COMMANDE REMPLIR LE FORMULAIRE DE COMMANDE AVEC L'IDENTIFICATION CORRECTE DE TOUTES LES MESURES ET CARACTERISTIQUES.
 EN EL PEDIDO COMPLETE LA FORMA DE ORDEN CON LA IDENTIFICACIÓN ADECUADA DE TODAS LAS MEDIDAS Y CARACTERÍSTICAS.

101-120CM



FIXED PANEL
PANNEAU FIXE
PANEL FIJO

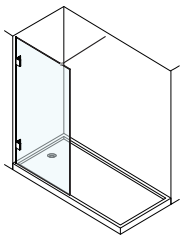

MEASUREMENTS MESURES MEDIDAS	TRANSPARENT TRANSPARENT TRANSPARENTE	SERIGRAPHED FOGGED SÉRIGRAPHÉ DÉPOLI SERIGRAFADO FOSCO
60 - 80 CM		
81 - 100 CM		
101 - 120 CM		
121 - 140 CM		
141 - 160 CM		

FIXED PANEL | SERIGRAPHED GLASS
PANNEAU FIXE | VERRE SÉRIGRAPHÉ
PANEL FIJO | VIDRIO SERIGRAFADO

SHOWER ENCLOSURE W/ 1 DOOR + 1 FIXED PANEL (CENTRAL CLOSING)
PAROIS DE DOUCHE A/ 1 PORTE + 1 PANNEAU FIXE (FERMETURE DU CENTRE)
MAMPARA DE DUCHA C/ 1 PUERTA + 1 PANEL FIJO (CIERRE CENTRAL)

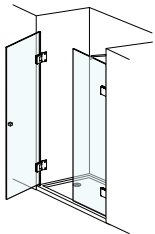

MEASUREMENTS MESURES MEDIDAS	TRANSPARENT TRANSPARENT TRANSPARENTE	SERIGRAPHED FOGGED SÉRIGRAPHÉ DÉPOLI SERIGRAFADO FOSCO
60 - 80 CM		
81 - 100 CM		
101 - 120 CM		
121 - 140 CM		
141 - 160 CM		

SHOWER ENCLOSURE W/ 1 DOOR + 1 FIXED PANEL (SIDE CLOSING)
PAROIS DE DOUCHE A/ 1 PORTE + 1 PANNEAU FIXE (FERMETURE LATÉRALE)
MAMPARA DE DUCHA C/ 1 PUERTA + 1 PANEL FIJO (CIERRE LATERAL)

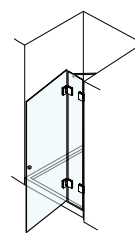

MEASUREMENTS MESURES MEDIDAS	TRANSPARENT TRANSPARENT TRANSPARENTE	SERIGRAPHED FOGGED SÉRIGRAPHÉ DÉPOLI SERIGRAFADO FOSCO
60 - 80 CM		
81 - 100 CM		
101 - 120 CM		
121 - 140 CM		
141 - 160 CM		

SHOWER ENCLOSURE W/ 2 DOORS
PAROIS DE DOUCHE A/ 2 PORTES
MAMPARA DE DUCHA C/ 2 PUERTAS

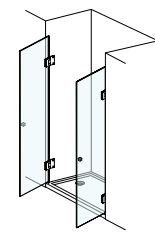

MEASUREMENTS MESURES MEDIDAS	TRANSPARENT TRANSPARENT TRANSPARENTE	SERIGRAPHED FOGGED SÉRIGRAPHÉ DÉPOLI SERIGRAFADO FOSCO
60 - 80 CM		
81 - 100 CM		
101 - 120 CM		
121 - 140 CM		
141 - 160 CM		

SHOWER ENCLOSURE W/ 1 DOOR
PAROIS DE DOUCHE A/ 1 PORTE
MAMPARA DE DUCHA C/ 1 PUERTA

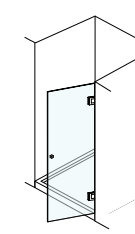

MEASUREMENTS MESURES MEDIDAS	TRANSPARENT TRANSPARENT TRANSPARENTE	SERIGRAPHED FOGGED SÉRIGRAPHÉ DÉPOLI SERIGRAFADO FOSCO
50 - 60 CM		
61 - 70 CM		
71 - 80 CM		
81 - 90 CM		

SHOWER ENCLOSURE W/ 1 DOOR + 2 FIXED PANELS
PAROIS DE DOUCHE A/ 1 PORTE + 2 PANNEAUX FIXES
MAMPARA DE DUCHA C/ 1 PUERTA + 2 PANELES FIJOS

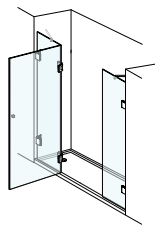

MEASUREMENTS MESURES MEDIDAS	TRANSPARENT TRANSPARENT TRANSPARENTE	SERIGRAPHED FOGGED SÉRIGRAPHÉ DÉPOLI SERIGRAFADO FOSCO
120 - 140 CM		
141 - 160 CM		
161 - 180 CM		
181 - 200 CM		
201 - 220 CM		

SHOWER ENCLOSURE W/ 2 DOORS + 2 FIXED PANELS
PAROIS DE DOUCHE A/ 2 PORTES + 2 PANNEAUX FIXES
MAMPARA DE DUCHA C/ 2 PUERTAS + 2 PANELES FIJOS

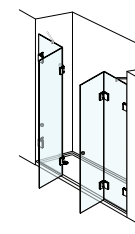

MEASUREMENTS MESURES MEDIDAS	TRANSPARENT TRANSPARENT TRANSPARENTE	SERIGRAPHED FOGGED SÉRIGRAPHÉ DÉPOLI SERIGRAFADO FOSCO
140 - 160 CM		
161 - 180 CM		
181 - 200 CM		
201 - 220 CM		
221 - 240 CM		

WHEN ORDERING MUST FILL THE DOCUMENT FOR THE CORRECT IDENTIFICATION OF ALL MEASURES AND FEATURES INTENDED.
A LA COMMANDE REMPLIR LE FORMULAIRE DE COMMANDE AVEC L'IDENTIFICATION CORRECTE DE TOUTES LES MESURES ET CARACTÉRISTIQUES.
EN EL PEDIDO COMPLETE LA FORMA DE ORDEN CON LA IDENTIFICACIÓN ADECUADA DE TODAS LAS MEDIDAS Y CARACTERÍSTICAS.

140 -160CM

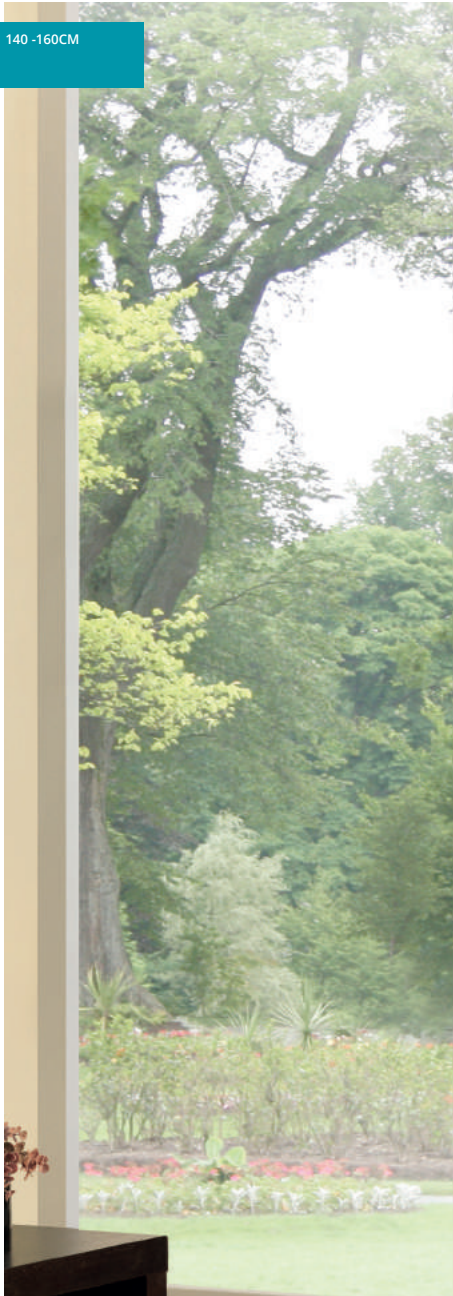

SHOWER ENCLOSURE W/ 1 FOLDING DOOR + 1 SIDE PANEL
 PAROIS DE DOUCHE A/ 1 PORTE PLIANTE + 1 PANNEAU LATÉRAL
 MAMPARA DE DUCHA C/ 1 PUERTA PLEGABLE + 1 PANEL LATERAL

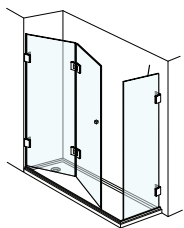

MEASUREMENTS MESURES MEDIDAS	TRANSPARENT TRANSPARENT TRANSPARENTE	SERIGRAPHED FOGGED SERIGRAPHÉ DÉPOLI SERIGRAFADO FOSCO
140 - 160 CM		
161 - 180 CM		
181 - 200 CM		
201 - 220 CM		
221 - 240 CM		

SHOWER ENCLOSURE W/ 1 FOLDING DOOR + 1 SIDE PANEL + 1 FIXED PANEL
 PAROIS DE DOUCHE A/ 1 PORTE PLIANTE + 1 PANNEAU LATÉRAL + 1 PANNEAU FIXE
 MAMPARA DE DUCHA C/ 1 PUERTA PLEGABLE + 1 PANEL LATERAL + 1 PANEL FIJO

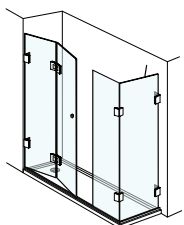

MEASUREMENTS MESURES MEDIDAS	TRANSPARENT TRANSPARENT TRANSPARENTE	SERIGRAPHED FOGGED SERIGRAPHÉ DÉPOLI SERIGRAFADO FOSCO
140 - 160 CM		
161 - 180 CM		
181 - 200 CM		
201 - 220 CM		
221 - 240 CM		

SHOWER ENCLOSURE W/ 2 FOLDING DOORS
 PAROIS DE DOUCHE A/ 2 PORTES PLIANTES
 MAMPARA DE DUCHA C/ 2 PUERTAS PLEGABLES

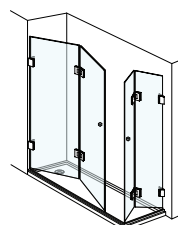

MEASUREMENTS MESURES MEDIDAS	TRANSPARENT TRANSPARENT TRANSPARENTE	SERIGRAPHED FOGGED SERIGRAPHÉ DÉPOLI SERIGRAFADO FOSCO
140 - 160 CM		
161 - 180 CM		
181 - 200 CM		
201 - 220 CM		
221 - 240 CM		

WHEN ORDERING MUST FILL THE DOCUMENT FOR THE CORRECT IDENTIFICATION OF ALL MEASURES AND FEATURES INTENDED.
 A LA COMMANDE REMPLIR LE FORMULAIRE DE COMMANDE AVEC L'IDENTIFICATION CORRECTE DE TOUTES LES MESURES ET CARACTERISTIQUES.
 EN EL PEDIDO COMPLETE LA FORMA DE ORDEN CON LA IDENTIFICACIÓN ADECUADA DE TODAS LAS MEDIDAS Y CARACTERÍSTICAS.

SHOWER ENCLOSURES // PAROIS DE DOUCHE // MAMPARAS DE DUCHA

SHOWER ENCLOSURE W/ 2 DOORS
 PAROIS DE DOUCHE A/ 2 PORTES
 MAMPARA DE DUCHA C/ 2 PUERTAS

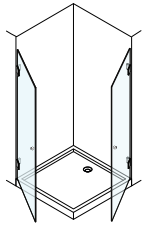

MEASUREMENTS MESURES MEDIDAS	TRANSPARENT TRANSPARENT TRANSPARENTE	SERIGRAPHED FOGGED SERIGRAPHIE DÉPOLI SERIGRAFADO FOSCO
120 - 140 CM		
141 - 160 CM		
161 - 180 CM		

SHOWER ENCLOSURE W/ 2 DOORS + 2 FIXED PANELS
 PAROIS DE DOUCHE A/ 2 PORTES + 2 PANNEAUX FIXES
 MAMPARA DE DUCHA C/ 2 PUERTAS + 2 PANELS FIJOS

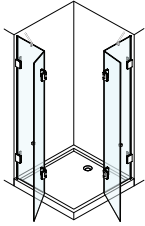

MEASUREMENTS MESURES MEDIDAS	TRANSPARENT TRANSPARENT TRANSPARENTE	SERIGRAPHED FOGGED SERIGRAPHIE DÉPOLI SERIGRAFADO FOSCO
120 - 140 CM		
141 - 160 CM		
161 - 180 CM		
181 - 200 CM		
201 - 220 CM		
221 - 240 CM		

SHOWER ENCLOSURE W/ 1 DOOR + 1 FIXED PANEL + 1 SIDE PANEL (SIDE CLOSING)
 PAROIS DE DOUCHE A/ 1 PORTE + 1 PANNEAU FIXE + 1 PANEL FIJO (FERMETURE LATÉRAL)
 MAMPARA DE DUCHA C/ 1 PUERTA + 1 PANEL FIJO + 1 PANEL LATERAL (CIERRE LATERAL)

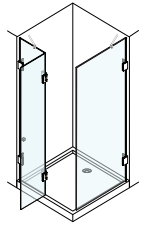

MEASUREMENTS MESURES MEDIDAS	TRANSPARENT TRANSPARENT TRANSPARENTE	SERIGRAPHED FOGGED SERIGRAPHIE DÉPOLI SERIGRAFADO FOSCO
140 - 160 CM		
161 - 180 CM		
181 - 200 CM		
201 - 220 CM		
221 - 240 CM		

SHOWER ENCLOSURE W/ 1 DOOR + 1 FIXED PANEL + 1 SIDE PANEL (CENTRAL CLOSING)
 PAROIS DE DOUCHE A/ 1 PORTE + 1 P. FIXE + 1 P. FIJO (FERMETURE DU CENTRE)
 MAMPARA DE DUCHA C/ 1 PUERTA + 1 P. FIJO + 1 P. LATERAL (CIERRE CENTRAL)

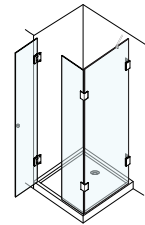

MEASUREMENTS MESURES MEDIDAS	TRANSPARENT TRANSPARENT TRANSPARENTE	SERIGRAPHED FOGGED SERIGRAPHIE DÉPOLI SERIGRAFADO FOSCO
140 - 160 CM		
161 - 180 CM		
181 - 200 CM		
201 - 220 CM		
221 - 240 CM		

SHOWER ENCLOSURE W/ 1 DOOR + 1 SIDE PANEL
 PAROIS DE DOUCHE A/ 1 PORTE + 1 PANEL FIJO
 MAMPARA DE DUCHA C/ 1 PUERTA + 1 PANEL LATERAL

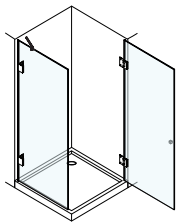

MEASUREMENTS MESURES MEDIDAS	TRANSPARENT TRANSPARENT TRANSPARENTE	SERIGRAPHED FOGGED SERIGRAPHIE DÉPOLI SERIGRAFADO FOSCO
120 - 140 CM		
141 - 160 CM		
161 - 180 CM		
181 - 200 CM		

SHOWER ENCLOSURE W/ 2 DOORS + 2 FIXED PANELS + 1 SIDE PANEL
 PAROIS DE DOUCHE A/ 2 PORTES + 2 PANNEAUX FIXES + 1 PANEL LATÉRAL
 MAMPARA DE DUCHA C/ 2 PUERTAS + 2 PANNEAUX FIXES + 1 PANEL LATERAL

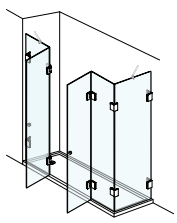

MEASUREMENTS MESURES MEDIDAS	TRANSPARENT TRANSPARENT TRANSPARENTE	SERIGRAPHED FOGGED SERIGRAPHIE DÉPOLI SERIGRAFADO FOSCO
160 - 180 CM		
181 - 200 CM		
201 - 220 CM		
221 - 240 CM		
241 - 260 CM		



SHOWER ENCLOSURE W/ 1 DOOR + 2 FIXED PANELS + 1 SIDE PANEL
 PAROIS DE DOUCHE A/ 1 PORTE + 2 PANNEAUX FIXES + 1 PANEL LATÉRAL
 MAMPARA DE DUCHA C/ 1 PUERTA + 2 PANNEAUX FIXES + 1 PANEL LATERAL

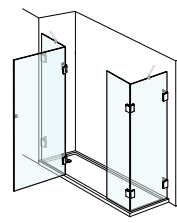

MEASUREMENTS MESURES MEDIDAS	TRANSPARENT TRANSPARENT TRANSPARENTE	SERIGRAPHED FOGGED SERIGRAPHIE DÉPOLI SERIGRAFADO FOSCO
160 - 180 CM		
181 - 200 CM		
201 - 220 CM		
221 - 240 CM		
241 - 260 CM		

WHEN ORDERING MUST FILL THE DOCUMENT FOR THE CORRECT IDENTIFICATION OF ALL MEASURES AND FEATURES INTENDED.
 A LA COMMANDE REMPLIR LE FORMULAIRE DE COMMANDE AVEC L'IDENTIFICATION CORRECTE DE TOUTES LES MESURES ET CARACTÉRISTIQUES.
 EN EL PEDIDO COMPLETE LA FORMA DE ORDEN CON LA IDENTIFICACIÓN ADECUADA DE TODAS LAS MEDIDAS Y CARACTERÍSTICAS.



SHOWER ENCLOSURE WITH 1 DOOR, 2 FIXED PANELS AND 1 LATERAL PANEL | TRANSPARENT GLASS
 PAROIS DE DOUCHE AVEC 1 PORTE, 2 PANNEAUX FIXES ET 1 PANNEAU LATÉRAL | VERRE TRANSPARENT
 MAMPARA DE DUCHA CON 1 PUERTA, 1 PANELES FIJOS Y 1 PANEL LATERAL | VIDRIO TRANSPARENTE

Built in 8 mm tempered glass and equipped with fittings and sturdy hinges with contemporary design. CRIMP stands out for the strength of its materials that give you maximum comfort in the shower with a perfect seal.

Construit en 8 mm en verre trempé et équipé avec des accessoires et des charnières robustes de design contemporain. CRIMP se distingue par la résistance des matériaux qui vous donnent un maximum de confort dans la douche avec une parfaite étanchéité.

Construida en vidrio templado de 8 mm y equipada con accesorios y bisagras resistentes de diseño contemporáneo. CRIMP se destaca por la solidez de los materiales que le proporcionan el máximo confort en la ducha con un sellado perfecto.

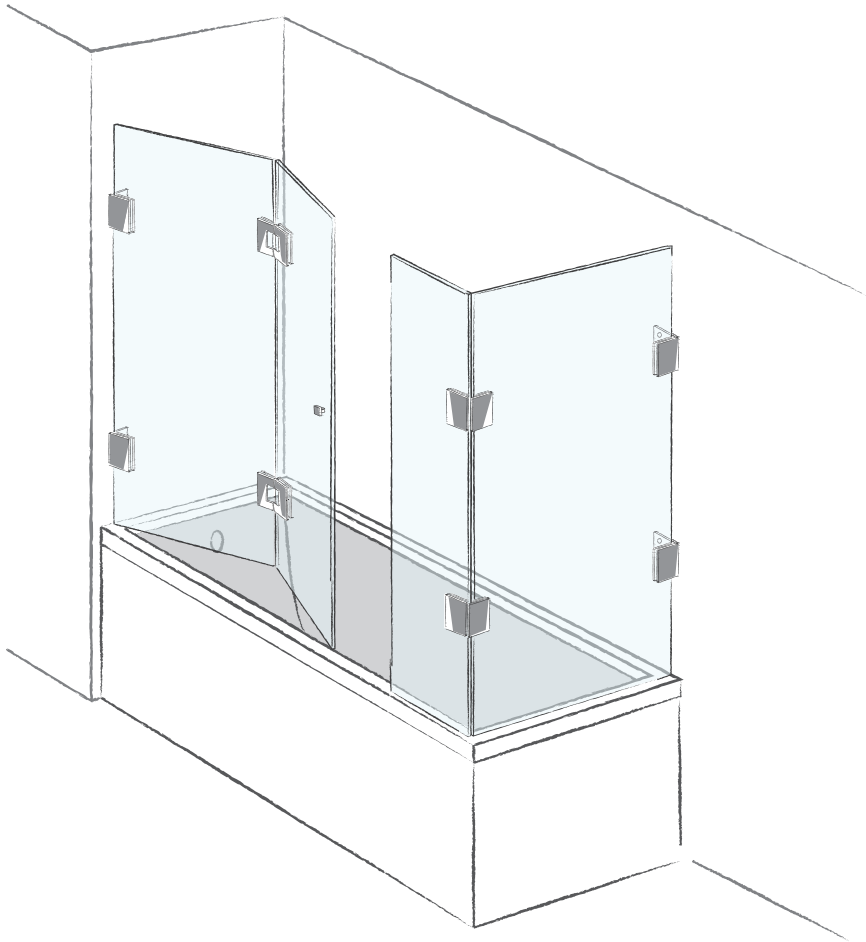

CRIMP SOLUTIONS FOR BATHTUB

Enjoy the supreme comfort of your bath or shower in the tub with frontal Crimp solutions that we present you.

With an excellent performance in terms of sealing, this minimalist aesthetic model combines with noble and robust materials to provide you a comfortable and relaxing bath.

CRIMP SOLUTIONS POUR BAIGNOIRE

Profitez du confort de votre bain ou douche dans la baignoire avec les solutions frontales Crimp que nous vous présentons.

Avec une excellente performance en termes d'étanchéité, ce modèle combine l'esthétique minimale avec des matériaux nobles et robustes pour vous fournir un bain confortable et relaxant.

CRIMP SOLUCIONES PARA BAÑERA

Disfrute de la comodidad de su baño o ducha en la bañera con las soluciones de mamparas frontales Crimp que vos presentamos.

Con excelentes prestaciones cuanto al sellado, este modelo combina la estética minimalista con materiales nobles y robustos para ofrecerle un baño confortable y relajante.

SHOWER ENCLOSURE W/ 1 FOLDING DOOR + 1 SIDE PANEL
PARE-BAIGNOIRE A/ 1 PORTE PLIANTE + 1 PANNEAU LATÉRAL
MAMPARA DE BAÑO C/ 1 PUERTA + 1 PANEL LATERAL

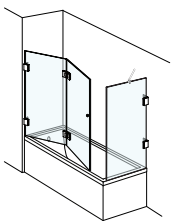

MEASUREMENTS MESURES MEDIDAS	TRANSPARENT TRANSPARENT TRANSPARENTE	SERIGRAPHED FOGGED SERIGRAPHÉ DÉPOLI SERIGRAFADO FOSCO
180 - 200 CM		
201 - 220 CM		
221 - 240 CM		

SHOWER ENCLOSURE W/ 1 FOLDING DOOR
PARE-BAIGNOIRE A/ 1 PORTE PLIANTE
MAMPARA DE BAÑO C/ 1 PUERTA PLEGABLE

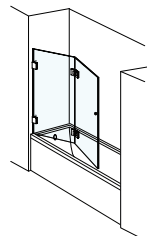

MEASUREMENTS MESURES MEDIDAS	TRANSPARENT TRANSPARENT TRANSPARENTE	SERIGRAPHED FOGGED SERIGRAPHÉ DÉPOLI SERIGRAFADO FOSCO
60 - 80 CM		
81 - 100 CM		
101 - 120 CM		
121 - 140 CM		

SHOWER ENCLOSURE W/ 1 FOLDING DOOR + 1 SIDE PANEL + 1 FIXED PANEL
PARE-BAIGNOIRE A/ 1 PORTE PLIANTE + 1 PANNEAU LATÉRAL + 1 PANNEAU FIXE
MAMPARA DE BAÑO C/ 1 PUERTA PLEGABLE + 1 PANEL LATERAL + 1 PANEL FIJO

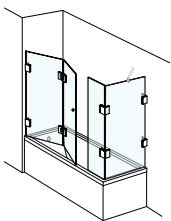

MEASUREMENTS MESURES MEDIDAS	TRANSPARENT TRANSPARENT TRANSPARENTE	SERIGRAPHED FOGGED SERIGRAPHÉ DÉPOLI SERIGRAFADO FOSCO
180 - 200 CM		
201 - 220 CM		
221 - 240 CM		
241 - 260 CM		

SHOWER ENCLOSURE W/ 1 FOLDING DOOR + 1 FIXED PANEL
PARE-BAIGNOIRE A/ 1 PORTE PLIANTE + 1 PANNEAU FIXE
MAMPARA DE BAÑO C/ 1 PUERTA PLEGABLE + 1 PANEL FIJO

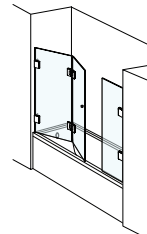

MEASUREMENTS MESURES MEDIDAS	TRANSPARENT TRANSPARENT TRANSPARENTE	SERIGRAPHED FOGGED SERIGRAPHÉ DÉPOLI SERIGRAFADO FOSCO
120 - 140 CM		
141 - 160 CM		
161 - 180 CM		
181 - 200 CM		

SHOWER ENCLOSURE W/ 2 FOLDING DOORS
PARE-BAIGNOIRE A/ 2 PORTES PLIANTES
MAMPARA DE BAÑO C/ 2 PUERTAS PLEGABLES

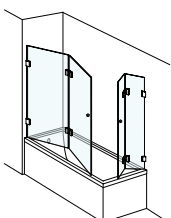

MEASUREMENTS MESURES MEDIDAS	TRANSPARENT TRANSPARENT TRANSPARENTE	SERIGRAPHED FOGGED SERIGRAPHÉ DÉPOLI SERIGRAFADO FOSCO
180 - 200 CM		
201 - 220 CM		
221 - 240 CM		

SHOWER ENCLOSURE W/ 2 FOLDING DOORS
PARE-BAIGNOIRE A/ 2 PORTES PLIANTES
MAMPARA DE BAÑO C/ 2 PUERTAS PLEGABLES

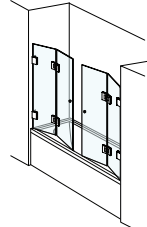

MEASUREMENTS MESURES MEDIDAS	TRANSPARENT TRANSPARENT TRANSPARENTE	SERIGRAPHED FOGGED SERIGRAPHÉ DÉPOLI SERIGRAFADO FOSCO
120 - 140 CM		
141 - 160 CM		
161 - 180 CM		
181 - 200 CM		
201 - 220 CM		

WHEN ORDERING MUST FILL THE DOCUMENT FOR THE CORRECT IDENTIFICATION OF ALL MEASURES AND FEATURES INTENDED.
À LA COMMANDE REMPLIR LE FORMULAIRE DE COMMANDE AVEC L'IDENTIFICATION CORRECTE DE TOUTES LES MESURES ET CARACTÉRISTIQUES.
EN EL PEDIDO COMPLETE LA FORMA DE ORDEN CON LA IDENTIFICACIÓN ADECUADA DE TODAS LAS MEDIDAS Y CARACTERÍSTICAS.



101-120CM

1 MOVING PANEL + 1 FIXED PANEL BATH SCREEN
 PARE-BAIGNOIRE 1 PANNEAU PIVOTANT + 1 PANNEAU FIXE
 SEPARADOR BAÑERA 1 PUERTA PRACTICABLE Y 1 HOJA FIJO

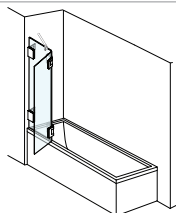

MEASUREMENTS MESURES MEDIDAS	TRANSPARENT TRANSPARENT TRANSPARENTE	SERIGRAPHED FOGGED SERIGRAPHIE DÉPOLI SERIGRAFADO FOSCO
80 - 100 CM		
101 - 120 CM		
121 - 140 CM		

1 MOVING PANEL + 1 FIXED PANEL BATH SCREEN | TRANSPARENT GLASS
 PARE-BAIGNOIRE 1 PANNEAU PIVOTANT + 1 PANNEAU FIXE | VERRE TRANSPARENT
 SEPARADOR BAÑERA 1 PUERTA PRACTICABLE | VIDRIO TRANSPARENTE

1 FIXED PANEL BATH SCREEN
 PARE-BAIGNOIRE 1 PANNEAU FIXE
 SEPARADOR BAÑERA 1 HOJA FIJO

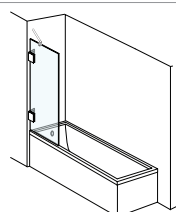

MEASUREMENTS MESURES MEDIDAS	TRANSPARENT TRANSPARENT TRANSPARENTE	SERIGRAPHED FOGGED SERIGRAPHIE DÉPOLI SERIGRAFADO FOSCO
40 - 60 CM		
61 - 80 CM		
81 - 100 CM		

1 MOVING PANEL BATH SCREEN
 PARE-BAIGNOIRE 1 PANNEAU PIVOTANT
 SEPARADOR BAÑERA 1 PUERTA PRACTICABLE

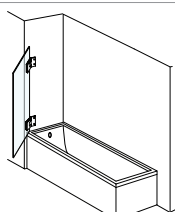

MEASUREMENTS MESURES MEDIDAS	TRANSPARENT TRANSPARENT TRANSPARENTE	SERIGRAPHED FOGGED SERIGRAPHIE DÉPOLI SERIGRAFADO FOSCO
40 - 60 CM		
61 - 80 CM		
81 - 100 CM		

BATH ENCLOSURE W/ 2 DOORS + 2 FIXED PANELS + 1 SIDE PANEL
 PARE-BAIGNOIRE A/ 2 PORTES + 2 PANNEAUX FIXES + 1 PANEL LATÉRAL
 MAMPARA DE BAÑO C/ 2 PUERTAS + 2 PANELES FIJOS + 1 PANEL LATERAL

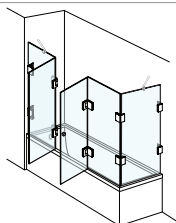

MEASUREMENTS MESURES MEDIDAS	TRANSPARENT TRANSPARENT TRANSPARENTE	SERIGRAPHED FOGGED SERIGRAPHIE DÉPOLI SERIGRAFADO FOSCO
180 - 200 CM		
201 - 220 CM		
221 - 240 CM		
241 - 260 CM		

BATH ENCLOSURE W/ 1 DOOR + 2 FIXED PANELS
 PARE-BAIGNOIRE A/ 1 PORTES + 2 PANNEAUX FIXES
 MAMPARA DE BAÑO C/ 1 PUERTA + 2 PANELES FIJOS

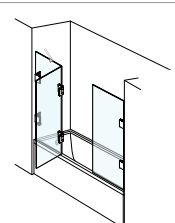

MEASUREMENTS MESURES MEDIDAS	TRANSPARENT TRANSPARENT TRANSPARENTE	SERIGRAPHED FOGGED SERIGRAPHIE DÉPOLI SERIGRAFADO FOSCO
120 - 140 CM		
141 - 160 CM		
161 - 180 CM		
181 - 200 CM		
201 - 220 CM		

BATH ENCLOSURE W/ 1 DOOR + 2 FIXED PANELS + 1 SIDE PANEL
 PARE-BAIGNOIRE A/ 2 PORTES + 2 PANNEAUX FIXES + 1 PANEL LATÉRAL
 MAMPARA DE BAÑO C/ 2 PUERTAS + 2 PANELES FIJOS + 1 PANEL LATERAL

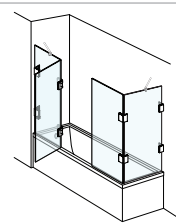

MEASUREMENTS MESURES MEDIDAS	TRANSPARENT TRANSPARENT TRANSPARENTE	SERIGRAPHED FOGGED SERIGRAPHIE DÉPOLI SERIGRAFADO FOSCO
180 - 200 CM		
201 - 220 CM		
221 - 240 CM		
241 - 260 CM		

BATH ENCLOSURE W/ 2 DOORS + 2 FIXED PANELS
 PARE-BAIGNOIRE A/ 2 PORTES + 2 PANNEAUX FIXES
 MAMPARA DE BAÑO C/ 2 PUERTAS + 2 PANELES FIJOS

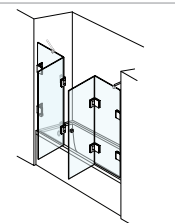

MEASUREMENTS MESURES MEDIDAS	TRANSPARENT TRANSPARENT TRANSPARENTE	SERIGRAPHED FOGGED SERIGRAPHIE DÉPOLI SERIGRAFADO FOSCO
120 - 140 CM		
141 - 160 CM		
161 - 180 CM		
181 - 200 CM		

WHEN ORDERING MUST FILL THE DOCUMENT FOR THE CORRECT IDENTIFICATION OF ALL MEASURES AND FEATURES INTENDED.
 A LA COMMANDE REMPLIR LE FORMULAIRE DE COMMANDE AVEC L'IDENTIFICATION CORRECTE DE TOUTES LES MESURES ET CARACTERISTIQUES.
 EN EL PEDIDO COMPLETE LA FORMA DE ORDEN CON LA IDENTIFICACIÓN ADECUADA DE TODAS LAS MEDIDAS Y CARACTERÍSTICAS.



SHOWER ENCLOSURE W/ 2 DOORS + 2 SIDE PANELS | TRANSPARENT GLASS
 PAROIS DE DOUCHE A/ 2 PORTES + 2 PANNEAUX LATÉRALES | VERRE TRANSPARENT
 MAMPARA DE DUCHA C/ 2 PUERTAS + 2 PANELES LATERALES | VIDRIO TRANSPARENTE

SHOWER ENCLOSURE W/ 2 DOORS + 2 SIDE PANELS
 PAROIS DE DOUCHE A/ 2 PORTES + 2 PANNEAUX LATÉRALES
 MAMPARA DE DUCHA C/ 2 PUERTAS + 2 PANELES LATERALES

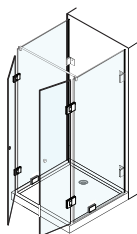

MEASUREMENTS MESURES MEDIDAS	TRANSPARENT TRANSPARENT TRANSPARENTE	SERIGRAPHED FOGGED SERIGRAPHIE DÉPOLI SERIGRAFADO FOSCO
200 - 220 CM		
221 - 240 CM		
241 - 260 CM		
261 - 280 CM		

SHOWER ENCLOSURE W/ 1 DOOR + 2 SIDE PANELS
 PAROIS DE DOUCHE A/ 1 PORTE + 2 PANNEAUX LATÉRALES
 MAMPARA DE DUCHA C/ 1 PUERTA + 2 PANELES LATERALES



MEASUREMENTS MESURES MEDIDAS	TRANSPARENT TRANSPARENT TRANSPARENTE	SERIGRAPHED FOGGED SERIGRAPHIE DÉPOLI SERIGRAFADO FOSCO
200 - 220 CM		
221 - 240 CM		
241 - 260 CM		
261 - 280 CM		

SHOWER ENCLOSURE W/ 2 DOORS + 1 SIDE PANEL
 PAROIS DE DOUCHE A/ 2 PORTES + 1 PANNEAU LATÉRAL
 MAMPARA DE DUCHA C/ 2 PUERTAS + 1 PANELE LATÉRAL

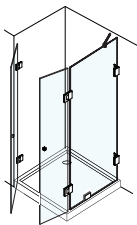

MEASUREMENTS MESURES MEDIDAS	TRANSPARENT TRANSPARENT TRANSPARENTE	SERIGRAPHED FOGGED SERIGRAPHIE DÉPOLI SERIGRAFADO FOSCO
160 - 180 CM		
181 - 200 CM		
201 - 220 CM		
221 - 240 CM		

SHOWER ENCLOSURE W/ 1 DOOR + 1 SIDE PANEL
 PAROIS DE DOUCHE A/ 1 PORTE + 1 PANNEAU LATÉRAL
 MAMPARA DE DUCHA C/ 1 PUERTA + 1 PANELE LATÉRAL

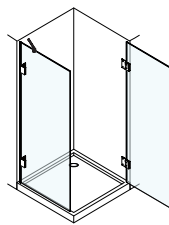

MEASUREMENTS MESURES MEDIDAS	TRANSPARENT TRANSPARENT TRANSPARENTE	SERIGRAPHED FOGGED SERIGRAPHIE DÉPOLI SERIGRAFADO FOSCO
120 - 140 CM		
141 - 160 CM		
161 - 180 CM		
181 - 200 CM		

SHOWER ENCLOSURE W/ 2 DOORS
 PAROIS DE DOUCHE A/ 2 PORTES
 MAMPARA DE DUCHA C/ 2 PUERTAS

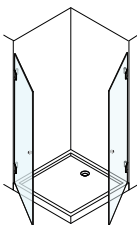

MEASUREMENTS MESURES MEDIDAS	TRANSPARENT TRANSPARENT TRANSPARENTE	SERIGRAPHED FOGGED SERIGRAPHIE DÉPOLI SERIGRAFADO FOSCO
120 - 140 CM		
141 - 160 CM		
161 - 180 CM		

SHOWER ENCLOSURE W/ 2 DOORS + 2 FIXED PANELS
 PAROIS DE DOUCHE A/ 2 PORTES + 2 PANNEAUX FIXES
 MAMPARA DE DUCHA C/ 2 PUERTAS + 2 PANELES FIJOS

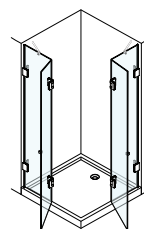

MEASUREMENTS MESURES MEDIDAS	TRANSPARENT TRANSPARENT TRANSPARENTE	SERIGRAPHED FOGGED SERIGRAPHIE DÉPOLI SERIGRAFADO FOSCO
120 - 140 CM		
141 - 160 CM		
161 - 180 CM		
181 - 200 CM		
201 - 220 CM		
221 - 240 CM		

WHEN ORDERING MUST FILL THE DOCUMENT FOR THE CORRECT IDENTIFICATION OF ALL MEASURES AND FEATURES INTENDED.
 A LA COMMANDE REMPLIR LE FORMULAIRE DE COMMANDE AVEC L'IDENTIFICATION CORRECTE DE TOUTES LES MESURES ET CARACTÉRISTIQUES.
 EN EL PEDIDO COMPLETE LA FORMA DE ORDEN CON LA IDENTIFICACIÓN ADECUADA DE TODAS LAS MEDIDAS Y CARACTERÍSTICAS.



SHOWER ENCLOSURE W/ 1 DOOR + 1 FIXED PANEL + 1 SIDE PANEL | TRANSPARENT GLASS
 PAROIS DE DOUCHE A/ 1 PORTE + 1 PANNEAU FIXE + 1 PANNEAU LATÉRAL | VERRE TRANSPARENT
 MAMPARA DE DUCHA C/ 1 PUERTA + 1 PANEL FIJO + 1 PANEL LATERAL | VIDRIO TRANSPARENTE

SHOWER ENCLOSURE W/ 1 DOOR + 1 FIXED PANEL + 1 SIDE PANEL (SIDE CLOSING)
 PAROIS DE DOUCHE A/ 1 PORTE + 1 PAN. FIXE + 1 PANNEAU LATÉRAL (FERMETURE LATÉRAL)
 MAMPARA DE DUCHA C/ 1 PUERTA + 1 PANEL FIJO + 1 PANEL LATERAL (CIERRE LATERAL)

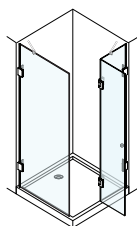

MEASUREMENTS MESURES MEDIDAS	TRANSPARENT TRANSPARENT TRANSPARENTE	SERIGRAPHED FOGGED SERIGRAPHÉ DÉPOLI SERIGRAFADO Fosco
160 - 180 CM		
181 - 200 CM		
201 - 220 CM		
221 - 240 CM		

6mm

FOLD

bellan

Shower and bath cabinets in tempered glass 6mm, transparent, serigraphed or fogged. Chromed brass fittings and magnetic closure. The opening system through damping hinges allow a wide access to the bathroom space. Height 200 cm

Parois de douche et baignoires en verre trempé de 6 mm, transparent, sérigraphié ou dépoli. Accessoires en laiton chromé et fermeture magnétique. Le système d'ouverture par charnières amortissantes permettent un large accès à l'espace de salle de bains. Hauteur 200 cm.

Mamparas de ducha y baño en vidrio templado de 6mm, transparente, serigrafado o mate. Ferrería en latón cromado y cierre magnético. El sistema de apertura a través de bisagras amortiguadoras permite un amplio acceso a la ducha. Altura: 200cm.



101-120CM
550.00



SHOWER ENCLOSURE W/ 1 DOOR + 1 FIXED PANEL (CENTRAL CLOSING)
PAROIS DE DOUCHE A/ 1 PORTE + 1 PANNEAU FIXE (FERMETURE DU CENTRE)
MAMPARA DE DUCHA C/ 1 PUERTA + 1 PANEL FIJO (CIERRE CENTRAL)

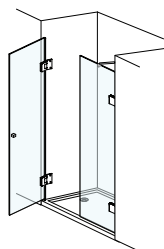

MEASUREMENTS MESURES MEDIDAS	TRANSPARENT TRANSPARENT TRANSPARENTE	SERIGRAPHED FOGGED SERIGRAPHIE DÉPOLI SERIGRAFADO FOSCO
60 - 80 CM		
81 - 100 CM		
101 - 120 CM		
121 - 140 CM		
141 - 160 CM		

SHOWER ENCLOSURE W/ 1 DOOR + 1 FIXED PANEL | TRANSPARENT GLASS
PAROIS DE DOUCHE A/ 1 PORTE + 1 PANNEAU FIXE | VERRE TRANSPARENT
MAMPARA DE DUCHA C/ 1 PUERTA + 1 PANEL FIJO | VIDRIO TRANSPARENTE

SHOWER ENCLOSURE W/ 1 DOOR + 1 FIXED PANEL (SIDE CLOSING)
PAROIS DE DOUCHE A/ 1 PORTE + 1 PANNEAU FIXE (FERMETURE LATÉRAL)
MAMPARA DE DUCHA C/ 1 PUERTA + 1 PANEL FIJO (CIERRE LATÉRAL)

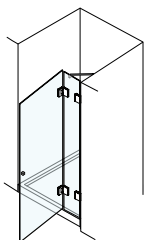

MEASUREMENTS MESURES MEDIDAS	TRANSPARENT TRANSPARENT TRANSPARENTE	SERIGRAPHED FOGGED SERIGRAPHIE DÉPOLI SERIGRAFADO FOSCO
60 - 80 CM		
81 - 100 CM		
101 - 120 CM		
121 - 140 CM		
141 - 160 CM		

SHOWER ENCLOSURE W/ 1 DOOR
PAROIS DE DOUCHE A/ 1 PORTE
MAMPARA DE DUCHA C/ 1 PUERTA

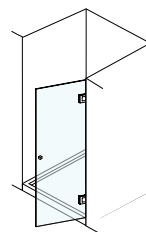

MEASUREMENTS MESURES MEDIDAS	TRANSPARENT TRANSPARENT TRANSPARENTE	SERIGRAPHED FOGGED SERIGRAPHIE DÉPOLI SERIGRAFADO FOSCO
50 - 60 CM		
61 - 70 CM		
71 - 80 CM		
81 - 90 CM		

SHOWER ENCLOSURE W/ 2 DOORS
PAROIS DE DOUCHE A/ 2 PORTES
MAMPARA DE DUCHA C/ 2 PUERTAS

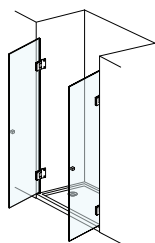

MEASUREMENTS MESURES MEDIDAS	TRANSPARENT TRANSPARENT TRANSPARENTE	SERIGRAPHED FOGGED SERIGRAPHIE DÉPOLI SERIGRAFADO FOSCO
60 - 80 CM		
81 - 100 CM		
101 - 120 CM		
121 - 140 CM		
141 - 160 CM		

SHOWER ENCLOSURE W/ 1 DOOR + 2 FIXED PANELS
PAROIS DE DOUCHE A/ 1 PORTE + 2 PANNEAUX FIXES
MAMPARA DE DUCHA C/ 1 PUERTA + 2 PANEALES FIJOS

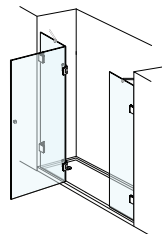

MEASUREMENTS MESURES MEDIDAS	TRANSPARENT TRANSPARENT TRANSPARENTE	SERIGRAPHED FOGGED SERIGRAPHIE DÉPOLI SERIGRAFADO FOSCO
140 - 160 CM		
161 - 180 CM		
181 - 200 CM		
201 - 220 CM		
221 - 240 CM		

SHOWER ENCLOSURE W/ 2 DOORS + 2 FIXED PANELS
PAROIS DE DOUCHE A/ 2 PORTES + 2 PANNEAUX FIXES
MAMPARA DE DUCHA C/ 2 PUERTAS + 2 PANEALES FIJOS

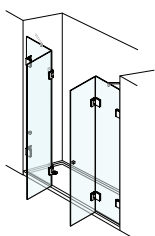

MEASUREMENTS MESURES MEDIDAS	TRANSPARENT TRANSPARENT TRANSPARENTE	SERIGRAPHED FOGGED SERIGRAPHIE DÉPOLI SERIGRAFADO FOSCO
140 - 160 CM		
161 - 180 CM		
181 - 200 CM		
201 - 220 CM		
221 - 240 CM		

FIXED PANEL
PANNEAU FIXE
PANEL FIJO

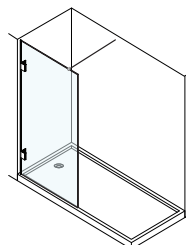

MEASUREMENTS MESURES MEDIDAS	TRANSPARENT TRANSPARENT TRANSPARENTE	SERIGRAPHED FOGGED SERIGRAPHIE DÉPOLI SERIGRAFADO FOSCO
60 - 80 CM		
81 - 100 CM		
101 - 120 CM		
121 - 140 CM		
141 - 160 CM		

WHEN ORDERING MUST FILL THE DOCUMENT FOR THE CORRECT IDENTIFICATION OF ALL MEASURES AND FEATURES INTENDED.
A LA COMMANDE REMPLIR LE FORMULAIRE DE COMMANDE AVEC L'IDENTIFICATION CORRECTE DE TOUTES LES MESURES ET CARACTÉRISTIQUES.
EN EL PEDIDO COMPLETE LA FORMA DE ORDEN CON LA IDENTIFICACIÓN ADECUADA DE TODAS LAS MEDIDAS Y CARACTERÍSTICAS.



BATH ENCLOSURE WITH 1 DOOR AND 2 FIXED PANELS | TRANSPARENT GLASS
 PARE-BAIGNOIRE AVEC 1 PORTE ET 2 PANNEAUX FIXES | VERRE TRANSPARENT
 MAMPARA DE BAÑO CON 1 PUERTA + 2 PANELES FIJOS | VIDRIO TRANSPARENTE

BATH ENCLOSURE W/ 1 DOOR + 2 FIXED PANELS
 PARE-BAIGNOIRE A/ 1 PORTE + 2 PANELES FIXES
 MAMPARA DE DUCHA C/ 1 PUERTA + 2 PANELES FIJOS

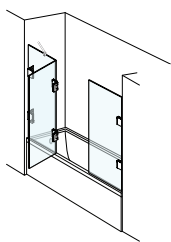

MEASUREMENTS MESURES MEDIDAS	TRANSPARENT TRANSPARENT TRANSPARENTE	SERIGRAPHED FOGGED SERIGRAFIE DÉPOLI SERIGRAFADO FOSCO
140 - 160 CM		
161 - 180 CM		
181 - 200 CM		

BATH ENCLOSURE W/ 2 DOORS + 2 FIXED PANELS
 PARE-BAIGNOIRE A/ 2 PORTES + 2 PANELES FIXES
 MAMPARA DE DUCHA C/ 2 PUERTAS + 2 PANELES FIJOS

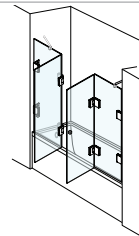

MEASUREMENTS MESURES MEDIDAS	TRANSPARENT TRANSPARENT TRANSPARENTE	SERIGRAPHED FOGGED SERIGRAFIE DÉPOLI SERIGRAFADO FOSCO
140 - 160 CM		
161 - 180 CM		
181 - 200 CM		

1 FIXED PANEL BATH SCREEN
 PARE-BAIGNOIRE 1 PANNEAU FIXE
 SEPARADOR BAÑERA 1 HOJA FIJO

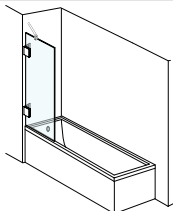

MEASUREMENTS MESURES MEDIDAS	TRANSPARENT TRANSPARENT TRANSPARENTE	SERIGRAPHED FOGGED SERIGRAFIE DÉPOLI SERIGRAFADO FOSCO
40 - 60 CM		
61 - 80 CM		
81 - 100 CM		

1 MOVING PANEL BATH SCREEN
 PARE-BAIGNOIRE 1 PANNEAU PIVOTANT
 SEPARADOR BAÑERA 1 PUERTA PRACTICABLE

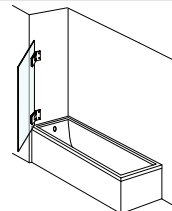

MEASUREMENTS MESURES MEDIDAS	TRANSPARENT TRANSPARENT TRANSPARENTE	SERIGRAPHED FOGGED SERIGRAFIE DÉPOLI SERIGRAFADO FOSCO
40 - 60 CM		
61 - 80 CM		
81 - 100 CM		

1 MOVING PANEL + 1 FIXED PANEL BATH SCREEN
 PARE-BAIGNOIRE 1 PANNEAU PIVOTANT + 1 PANNEAU FIXE
 SEPARADOR BAÑERA 1 PUERTA PRACTICABLE Y 1 HOJA FIJO

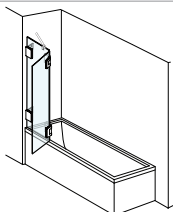

MEASUREMENTS MESURES MEDIDAS	TRANSPARENT TRANSPARENT TRANSPARENTE	SERIGRAPHED FOGGED SERIGRAFIE DÉPOLI SERIGRAFADO FOSCO
80 - 100 CM		
101 - 120 CM		
121 - 140 CM		



ROUND HANDLE
 POIGNÉE RONDE
 TIRADOR CUADRADO



WING HANDLE
 POIGNÉE ASA
 TIRADOR ASA

2

**TYPES
HANDLE**

**TYPES
POIGNÉE**

**MODELOS
TIRADORES**

WHEN ORDERING MUST FILL THE DOCUMENT FOR THE CORRECT IDENTIFICATION OF ALL MEASURES AND FEATURES INTENDED.
 A LA COMMANDE REMPLIR LE FORMULAIRE DE COMMANDE AVEC L'IDENTIFICATION CORRECTE DE TOUTES LES MESURES ET CARACTERISTIQUES.
 EN EL PEDIDO COMPLETE LA FORMA DE ORDEN CON LA IDENTIFICACIÓN ADECUADA DE TODAS LAS MEDIDAS Y CARACTERÍSTICAS.

70 - 20 - 70 CM

BATH ENCLOSURE WITH 1 FRONT PANEL 80CM, 1 CONNECTION PANEL 20 CM AND 1 SIDE PANEL 80CM
45° WALL-GLASS FIXING ACCESSORY
180° GLASS-GLASS FIXING ACCESSORY
TRANSPARENT GLASS

PAROIS DE DOUCHE AVEC 1 PANNEAU FRONTAL 80CM, 1 PANNEAU DE CONNEXION 20CM ET 1 PANNEAU LATÉRAL 80CM
45° MUR-VERRE ACCESSOIRE DE FIXATION
180° MUR-VERRE ACCESSOIRE DE FIXATION
VERRE TRANSPARENT

MAMPARA DE DUCHA CON 1 PANEL FRONTAL 80CM, 1 PANEL CONEXION 20CM, 1 PANEL LATERAL 80CM
45° MURAL-VIDRIO ACCESORIO DE FIJACIÓN
180° MURAL-VIDRIO ACCESORIO DE FIJACIÓN
VIDRIO TRANSPARENTE

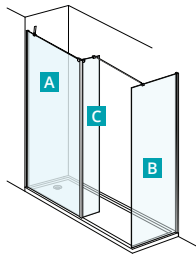

FRONT PANEL (A)
CONNECTION PANEL (C)
SIDE FIXED PANEL (B)

PANNEAU FRONTAL (A)
PANNEAU DE CONNEXION (C)
PANNEAU FIXE (B)

PANEL FRONTAL (A)
PANEL CONEXIÓN (C)
PANEL FIJO (B)

SIDE FIXED PANEL (B)

PANNEAU FIXE (B)

PANEL FIJO (B)

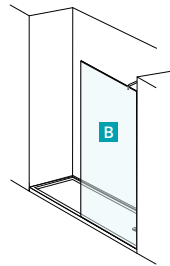

FRONT PANEL (A)
CONNECTION PANEL (C)

PANNEAU FRONTAL (A)
PANNEAU DE CONNEXION (C)

PANEL FRONTAL (A)
PANEL CONEXIÓN (C)

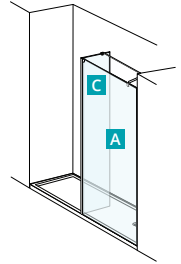

(A) FRONT PANEL
PANNEAU FRONTAL // PANEL FRONTAL

MEASUREMENTS MEDIDAS	TRANSPARENT TRANSPARENTE	SERIGRAPHED SERIGRAFADO
70 CM		
75 CM		
80 CM		
90 CM		
100 CM		

(B) SIDE FIXED PANEL
PANNEAU FIXE // PANEL FIJO

MEASUREMENTS MEDIDAS	TRANSPARENT TRANSPARENTE	SERIGRAPHED SERIGRAFADO
70 CM		
75 CM		
80 CM		
90 CM		

(C) CONNECTION PANEL
PANNEAU DE CONNEXION // PANEL CONEXIÓN

MEASUREMENTS MEDIDAS	TRANSPARENT TRANSPARENTE	SERIGRAPHED SERIGRAFADO
20 CM		
25 CM		
30 CM		



SQUARE

FIXING RODS

Fixing rods in brass with chrome finish for greater stability of your shower or bath enclosure. With extensible system for easy adjustment on 45 angled or straight to fit between glasses or at the wall. Available in two different designs so you can build your shower space according your needs.

TIGES DE FIXATION

Tiges de fixation en laiton avec finition chromé pour une plus grande stabilité de votre parois de douche ou baignoire. Avec le système extensible pour un réglage facile à droite ou en angle de 45° pour s'ajuster entre les verres ou au mur. Disponible en deux modèles différents afin que vous pouvez construire votre espace de douche à vos besoins.

BARRAS DE FIJACIÓN

Barras de fijación en latón con acabado cromo para una mayor estabilidad de su mampara de ducha o bañera. Con el sistema extensible facilita el ajuste a derecho o en ángulo recto de 45° para encajar entre vidrios o a la pared. Disponible en dos diseños diferentes para que pueda construir su espacio de ducha a su medida.



ROUND

ROUND

DESCRIPTION // DESCRIPTION // DESCRIPCIÓN

WALL - GLASS 45°
MUR - VERRE 45°
MURO - VIDRIO 45°

WALL - GLASS 180°
MUR - VERRE 180°
MURO - VIDRIO 180°

GLASS - GLASS 180°
VERRE - VERRE 180°
VIDRIO - VIDRIO 180°

SQUARE

DESCRIPTION // DESCRIPTION // DESCRIPCIÓN

WALL - GLASS 45°
MUR - VERRE 45°
MURO - VIDRIO 45°

WALL - GLASS 180°
MUR - VERRE 180°
MURO - VIDRIO 180°

GLASS - GLASS 180°
VERRE - VERRE 180°
VIDRIO - VIDRIO 180°

80 - 20 - 80CM

**BATH ENCLOSURE WITH 1 FRONT PANEL 80CM, 1 CONNECTION PANEL 20 CM AND 1 SIDE PANEL 80CM
45° WALL-GLASS FIXING ACCESSORY
180° GLASS-GLASS FIXING ACCESSORY
TRANSPARENT GLASS**

**PAROIS DE DOUCHE AVEC 1 PANNEAU FRONTAL 80CM, 1 PANNEAU DE CONNEXION 20CM ET 1 PANNEAU LATÉRAL 80CM
45° MUR-VERRE ACCESSOIRE DE FIXATION
180° MUR-VERRE ACCESSOIRE DE FIXATION
VERRE TRANSPARENT**

**MAMPARA DE DUCHA CON 1 PAINEL FRONTAL 80CM, 1 PANEL CONEXION 20CM, 1 PANEL LATERAL 80CM
45° MURAL-VIDRIO ACCESORIO DE FIJACIÓN
180° MURAL-VIDRIO ACCESORIO DE FIJACIÓN
VIDRIO TRANSPARENTE**



bellian

FORM

Shower enclosures in 6mm tempered glass, transparent or serigraphed. With chromed aluminum profiles and limpid design to give you full access to your shower space. Height 200cm.

Parois de douche en verre trempé de 6mm, transparent ou sérigraphié. Avec des profils en aluminium chromé, design épuré, pour vous donner le plein accès à votre espace de douche. Hauteur 200cm.

Mamparas de ducha en vidrio templado de 6 mm, transparente o serigrafiado. Con perfiles de aluminio cromado, diseño claro, para darle pleno acceso a su espacio de ducha. Altura 200cm.



140 CM

FIXED PANEL
8 MM TEMPERED GLASS
TRANSPARENT GLASS
EXTENDABLE ROD (70-100 CM)
HEIGHT 200 CM

PANNEAU FIXE
VERRE TREMPÉ 8 MM
VERRE TRANSPARENT
TIGE EXTENSIBLE (70-100 CM)
HAUTEUR 200 CM

PANEL FIJO
8MM VIDRIO TEMPLADO
VIDRIO TRANSPARENTE
BARRA EXTENSIBLE (70-100 CM)
ALTURA 200 CM

FIXED PANEL // PANNEAUX FIXES // PANEL FIJO

MEASUREMENTS MESURES MEDIDAS	TRANSPARENT TRANSPARENT TRANSPARENTE	SERIGRAPHED SERIGRAPHIE SERIGRAFADO
70 CM		
75 CM		
80 CM		
90 CM		
100 CM		
110 CM		
120 CM		
130 CM		
140 CM		
150 CM		

SPECIAL MEASUREMENTS // MESURES SPÉCIALES // MEDIDAS ESPECIALES

MINIMUM MINIMUM MINIMO	MAXIMUM MAXIMUM MAXIMO	TRANSPARENT TRANSPARENT TRANSPARENTE	SERIGRAPHED SERIGRAPHIE SERIGRAFADO
70 CM	90 CM		
91 CM	120 CM		
121 CM	150 CM		

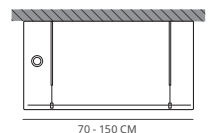

90 - 90 CM

SHOWER ENCLOSURE
 CHROMED FRAME
 6MM TEMPERED GLASS
 TRANSPARENT GLASS
 MAGNETIC CLOSE
 HEIGHT 185 CM
 ADJUSTMENT 2 CM FOR MEASURES LOWER THAN INDICATED

CABINE DE DOUCHE
 PROFILS CHROMÉ
 VERRE TREMPÉ 6MM
 VERRE TRANSPARENT
 FERMETURE MAGNÉTIQUE
 HAUTEUR 185 CM
 AJUSTEMENT 2 CM DE MESURES INFÉRIEUR À CELUI INDICQUÉ

MAMPARA DE DUCHA
 PERFIL CROMO
 VIDRIO TEMPLADO 6 MM
 VIDRIO TRANSPARENTE
 CIERRE MAGNÉTICO
 ALTURA 185 CM
 AJUSTE DE 2 CM EN LAS MEDIDAS INFERIORES A LA INDICADA

SHOWER ENCLOSURE
 CABINE DE DOUCHE // MAMPARA DE DUCHA

MEASUREMENTS MESURES MEDIDAS	TRANSPARENT TRANSPARENT	SERIGRAPHED SERIGRAPHIE SERIGRAFADO
70 x 70 CM		
70 x 90 CM		
70 x 100 CM		
70 x 110 CM		
70 x 120 CM		
70 x 130 CM		
70 x 140 CM		
70 x 150 CM		
70 x 160 CM		
75 x 75 CM		
75 x 90 CM		
75 x 100 CM		
75 x 110 CM		
75 x 120 CM		
75 x 130 CM		
75 x 140 CM		
75 x 150 CM		
75 x 160 CM		
80 x 80 CM		
80 x 90 CM		
80 x 100 CM		
80 x 110 CM		
80 x 120 CM		
80 x 130 CM		
80 x 140 CM		
80 x 150 CM		
80 x 160 CM		
90 x 90 CM		
90 x 100 CM		
90 x 110 CM		
90 x 120 CM		
90 x 130 CM		
90 x 140 CM		
90 x 150 CM		
90 x 160 CM		

SPECIAL MEASUREMENTS ADDS 25% TO THE PRICE OF THE PREVIOUS MEASURE
 DES MESURES SPÉCIALES AJOUTE 25% SUR LE PRIX DE LA MESURE PRÉCÉDENTE
 EDIDAS ESPECIALES AÑADEN 25% AL PRECIO DE LA MEDIDA ANTERIOR

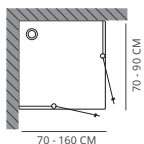

130 CM

GLASS
VERRE
VIDRIO
6
mm

FIXED PANEL
6 MM TEMPERED GLASS
SERIGRAPHED GLASS
CHROMED FRAME
REVERSIBLE
EXTENDABLE ROD (70-100 CM)
HEIGHT 190 CM

PANNEAU FIXE
VERRE TREMPÉ 6 MM
VERRE SÉRIGRAPHÉ
PROFIL CHROMÉ
RÉVERSIBLE
TIGE EXTENSIBLE (70-100 CM)
HAUTEUR 190 CM

PANEL FIJO
6MM VIDRIO TEMPLADO
VIDRIO SERIGRAFADO
PERFILE CROMO
REVERSIBLE
BARRA EXTENSIBLE (70-100 CM)
ALTURA 190 CM

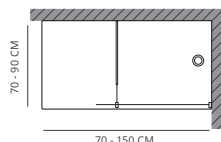

6 MM

FIXED PANEL // PANNEAU FIXE // PANEL FIJO

MEASUREMENTS MESURES MEDIDAS	TRANSPARENT TRANSPARENT TRANSPARENTE	SERIGRAPHED SÉRIGRAPHÉ SERIGRAFADO
70 CM		
75 CM		
80 CM		
90 CM		
100 CM		
110 CM		
120 CM		
130 CM		
140 CM		
150 CM		

SPECIAL MEASUREMENTS // MESURES SPÉCIALES // MEDIDAS ESPECIALES

MINIMUM MINIMUM MÍNIMO	MAXIMUM MAXIMUM MÁXIMO	TRANSPARENT TRANSPARENT TRANSPARENTE	SERIGRAPHED SÉRIGRAPHÉ SERIGRAFADO
70 CM	90 CM		
91 CM	120 CM		
121 CM	150 CM		

SPECIAL MEASUREMENTS: FROM 0 CM TO 20 CM ADDS 25% TO THE PRICE OF THE PREVIOUS MEASURE; 21 CM TO 40 CM ADDS 30% TO THE PRICE OF THE PREVIOUS MEASURE. IN CASE YOU NEED THE PANEL WITH THE 45° ROD SHOULD REFER UPO ORDER.
MESURES SPÉCIALES: 0 CM A 20 CM AJOUTE 25% SUR LE PRIX DE LA MESURE PRÉCÉDENTE; 21 CM A 40 CM AJOUTE 30% SUR LE PRIX DE LA MESURE PRÉCÉDENTE. EN CAS DE BESOIN DU PANNEAU AVEC TIGE À 45° DOIT RÉFÉRER SUR LA COMMANDE.
LAS MEDIDAS ESPECIALES DE 0 A 20 CM 25% AÑADE AL PRECIO DE LA MEDIDA ANTERIOR DE 21 CM A 40 CM 30% AÑADE AL PRECIO DE LA MEDIDA ANTERIOR. EN CASO DE QUE NECESITE EL PANEL CON LA VARILLA 45 DEBE HACER REFERENCIA A LA ORDEN.



110 X 90 CM

GLASS 8 mm
VERRE 8 mm
VIDRIO 8 mm

FIXED PANEL
8 MM TEMPERED GLASS
TRANSPARENT GLASS
CHROMED FRAME
REVERSIBLE
EXTENDABLE ROD (70-100 CM)
HEIGHT 190 CM

PANNEAU FIXE
VERRE TREMPÉ 6 MM
VERRE TRANSPARENT
PROFIL CHROMÉ
RÉVERSIBLE
TIGE EXTENSIBLE (70-100 CM)
HAUTEUR 190 CM

PANEL FIJO
6MM VIDRIO TEMPLADO
VIDRIO TRANSPARENTE
PERFILE CROMO
REVERSIBLE
BARRA EXTENSIBLE (70-100 CM)
ALTURA 190 CM

8 MM
FIXED PANEL // PANNEAU FIXE // PANEL FIJO

MEASUREMENTS MESURES MEDIDAS	TRANSPARENT TRANSPARENT TRANSPARENTE	SERIGRAPHED SERIGRAPHIE SERIGRAFADO
70 CM		
75 CM		
80 CM		
90 CM		
100 CM		
110 CM		
120 CM		
130 CM		
140 CM		
150 CM		

SPECIAL MEASUREMENTS // MESURES SPÉCIALES // MEDIDAS ESPECIALES

MINIMUM MINIMUM MÍNIMO	MAXIMUM MAXIMUM MÁXIMO	TRANSPARENT TRANSPARENT TRANSPARENTE	SERIGRAPHED SERIGRAPHIE SERIGRAFADO
70 CM	90 CM		
91 CM	120 CM		
121 CM	150 CM		

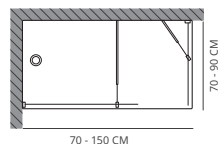

SPECIAL MEASUREMENTS: FROM 0 CM TO 20 CM ADDS 25% TO THE PRICE OF THE PREVIOUS MEASURE; 21 CM TO 40 CM ADDS 30% TO THE PRICE OF THE PREVIOUS MEASURE. IN CASE YOU NEED THE PANEL WITH THE 45° ROD SHOULD REFER UPON ORDER.
MESURES SPÉCIALES: 0 CM À 20 CM AJOUTE 25% SUR LE PRIX DE LA MESURE PRÉCÉDENTE; 21 CM À 40 CM AJOUTE 30% SUR LE PRIX DE LA MESURE PRÉCÉDENTE. EN CAS DE BESOIN DU PANNEAU AVEC TIGE À 45° DOIT RÉFÉRER SUR LA COMMANDE.
LAS MEDIDAS ESPECIALES DE 0 A 20 CM 25% AÑADE AL PRECIO DE LA MEDIDA ANTERIOR DE 21 CM A 40 CM 30% AÑADE AL PRECIO DE LA MEDIDA ANTERIOR. EN CASO DE QUE NECESITE EL PANEL CON LA VARILLA 45 DEBE HACER REFERENCIA A LA ORDEN.

80 X 80 CM

SHOWER ENCLOSURE WITH 1 PIVOT DOOR
SIDE PANEL
6MM TEMPERED FRAME
SERGRAPHED GLASS
CHROMED FRAME
REVERSIBLE
HEIGHT 185 CM

PAROIS DE DOUCHE AVEC 1 PORTE PIVOTANTE
PANNEAU LATÉRAL
VÉRRE TREMPÉ 6MM
VERRE SERIGRAPHIÉ
PROFIL CHROMÉ
REVERSIBLE
HAUTEUR 185 CM

MAMPARA DE DUCHA CON 1 PUERTA PIVOTANTE
PANEL LATERAL
6MM VIDRIO TEMPLADO
VIDRIO SERIGRAFADO
PERFILE CROMO
REVERSIBLE
ALTURA 185 CM

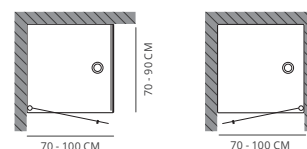
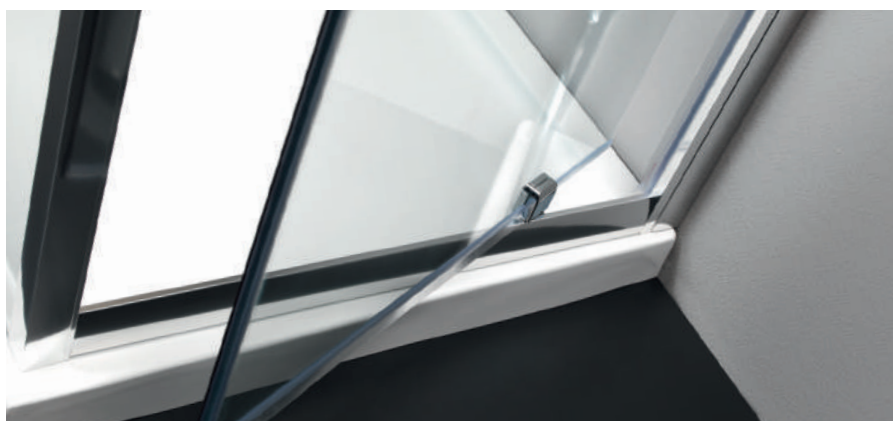



70 CM

SHOWER ENCLOSURE WITH 1 PIVOT DOOR
6MM TEMPERED GLASS
TRANSPARENT GLASS
CHROMED FRAME
REVERSIBLE
HEIGHT 185 CM

PAROIS DE DOUCHE AVEC 1 PORTE PIVOTANTE
VERRE TREMPÉ 6MM
VERRE TRANSPARENT
PROFIL CHROMÉ
REVERSIBLE
HAUTEUR 185 CM

MAMPARA DE DUCHA CON 1 PUERTA PIVOTANTE
6MM VIDRIO TEMPLADO
VIDRIO TRANSPARENT
PERFILE CROMO
REVERSIBLE
ALTURA 185 CM

FRONT PANEL // PANNEAU FRONTAL // PANEL FRONTAL

MEASUREMENTS MESURES MEDIDAS	ADJUST AJUSTER AJUSTE	TRANSPARENT TRANSPARENT TRANSPARENTE	SERIGRAPHED SERIGRAPHIE SERIGRAFADO
70 CM	70 75 CM		
75 CM	75 80 CM		
80 CM	80 85 CM		
85 CM	85 90 CM		
90 CM	90 95 CM		
95 CM	95 100 CM		

SIDE PANEL // PANNEAU LATÉRAL // PANEL LATERAL

MEASUREMENTS MESURES MEDIDAS	ADJUST AJUSTER AJUSTE	TRANSPARENT TRANSPARENT TRANSPARENTE	SERIGRAPHED SERIGRAPHIE SERIGRAFADO
70 CM	67,5 70 CM		
75 CM	72,5 75 CM		
80 CM	77,5 80 CM		
90 CM	87,5 90 CM		

SPECIAL MEASUREMENTS ADDS 25% TO THE PRICE OF THE PREVIOUS MEASURE. MAXIMUM HEIGHT 185 CM. MAXIMUM WIDTH 100 CM.
DES MESURES SPECIALES 25% SUR LE PRIX DE LA MESURE PRECEDENTE. HAUTEUR MAXIMALE 185 CM. LARGEUR MAXIMUM 100 CM.
LAS MEDIDAS ESPECIALES AÑADE 25% AL PRECIO DE LA MEDIDA ANTERIOR. ALTURA MÁXIMA 185 CM. ANCHURA MÁXIMA 100 CM.



75 CM

SHOWER ENCLOSURE
WITH 1 FOLDING DOOR
6MM TEMPERED GLASS
TRANSPARENT GLASS
CHROMED FRAME
REVERSIBLE
MAGNETIC CLOSE
HEIGHT 190 CM

PAROIS DE DOUCHE
AVEC 1 PORTE PLIANTE
VERRE TREMPÉ 6MM
VERRE TRANSPARENT
PROFIL CHROMÉ
REVERSIBLE
FERMETURE MAGNETIQUE
HAUTEUR 190 CM

MAMPARA DE DUCHA
CON 1 PUERTA PLEGABLE
6MM VIDRIO TEMPLADO
VIDRIO TRANSPARENT
PERFILE CROMO
REVERSIBLE
CIERRE MAGNETICO
ALTURA 190 CM



FRONT PANEL WITH FOLDING DOOR
PANNEAU FRONTAL AVEC PORTE PLIANTE
PANEL FRONTAL CON PUERTA PLEGABLE

MEASUREMENTS MESURES MEDIDAS	ADJUST AJUSTER AJUSTE	TRANSPARENT TRANSPARENT TRANSPARENTE	SERIGRAPHED SERIGRAPHÉ SERIGRAFADO
70 CM	68 - 73 CM		
75 CM	73 - 78 CM		
80 CM	78 - 83 CM		
85 CM	83 - 88 CM		
90 CM	88 - 93 CM		
95 CM	93 - 98 CM		
100 CM	98 - 103 CM		

SIDE PANEL // PANNEAU LATÉRAL // PANEL LATERAL

MEASUREMENTS MESURES MEDIDAS	ADJUST AJUSTER AJUSTE	TRANSPARENT TRANSPARENT TRANSPARENTE	SERIGRAPHED SERIGRAPHÉ SERIGRAFADO
70 CM	68 70 CM		
75 CM	73 75 CM		
80 CM	78 80 CM		
90 CM	88 90 CM		

ON THE OPTION WITH SIDE: THE FRONT ADJUSTMENT REDUCES 1 CM.
DANS L'OPTION AVEC LATÉRALE: L'AJUSTEMENT DOIT RÉDUIRE 1 CM.
EN LA OPCIÓN CON LATERAL: EL AJUSTE FRONTAL REDUCE DE 1 CM.

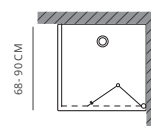
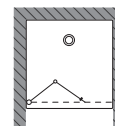



80 X 80 CM

SHOWER ENCLOSURE
WITH 1 FOLDING DOOR + SIDE PANEL
6MM TEMPERED GLASS
TRANSPARENT GLASS
CHROMED FRAME
REVERSIBLE
MAGNETIC CLOSE
HEIGHT 190 CM

PAROIS DE DOUCHE
AVEC 1 PORTE PLIANTE + PANNEAU LATÉRAL
VERRE TREMPÉ 6MM
VERRE TRANSPARENT
PROFIL CHROMÉ
REVERSIBLE
FERMETURE MAGNETIQUE
HAUTEUR 190 CM

MAMPARA DE DUCHA
CON 1 PUERTA PLEGABLE + 1 PANEL LATERAL
6MM VIDRIO TEMPLADO
VIDRIO TRANSPARENT
PERFILE CROMO
REVERSIBLE
CIERRE MAGNETICO
ALTURA 190 CM



bellian

FOLIA

Shower enclosures in tempered glass 6mm, transparent or serigraphed. With chrome aluminum profiles, folding doors to the interior for easy access to the shower. The magnetic closure and the bottom profiles contribute to an effective sealing and excellent performance of this model.

Parois de douche en verre trempé de 6mm, transparent ou sérigraphié. Les profils chromés en aluminium, portes pliantes à l'intérieur pour faciliter l'accès à la douche. La fermeture magnétique et les profils inférieurs contribuent à une étanchéité efficace et une excellente performance de ce modèle.

Mamparas de ducha en vidrio templado de 6 mm, transparente o serigrafiado. Con perfiles de aluminio cromado, puertas plegables de apertura para el interior para facilitar el acceso a la ducha. El cierre magnético y los perfiles inferiores contribuyen para crear un sellado efectivo y excelente desempeño de este modelo.



90 X 90 CM

SHOWER ENCLOSURE WITH 1 DOUBLE DOOR + SIDE PANEL
6MM TEMPERED GLASS
TRANSPARENT GLASS
CHROMED FRAME
REVERSIBLE
HEIGHT DOORS 95 CM
HEIGHT 190 CM

PAROIS DE DOUCHE AVEC 1 PORTE DOUBLE + PANNEAU LATÉRAL
VÉRRE TREMPÉ 6MM
VÉRRE TRANSPARENT
PROFIL CHROMÉ
REVERSIBLE
PORTES HAUTEUR 95 CM
HAUTEUR 190 CM

MAMPARA DE DUCHA CON 1 PUERTA DOBLE + PANEL LATERAL
6MM VIDRIO TEMPLADO
VIDRIO TRANSPARENT
PERFILE CROMO
REVERSIBLE
ALTURA PUERTAS 95CM
ALTURA 190 CM



90 X 90 CM

SHOWER ENCLOSURE WITH 2 DOUBLE DOORS
6MM TEMPERED GLASS
TRANSPARENT GLASS
CHROMED FRAME
REVERSIBLE
HEIGHT DOORS 95 CM
HEIGHT 190 CM

PAROIS DE DOUCHE AVEC 2 PORTES DOUBLE
VÉRRE TREMPÉ 6MM
VÉRRE TRANSPARENT
PROFIL CHROMÉ
REVERSIBLE
PORTES HAUTEUR 95 CM
HAUTEUR 190 CM

MAMPARA DE DUCHA CON 2 PUERTAS DOBLES
6MM VIDRIO TEMPLADO
VIDRIO TRANSPARENT
PERFILE CROMO
REVERSIBLE
ALTURA PUERTAS 95CM
ALTURA 190 CM

Clean&Safe

Shower cabins with double doors opening to the outside, designed for a wider access to the shower thinking to include all people, particularly in limited mobility situations.

Cabines de douche avec portes doubles d'ouverture à l'extérieur, conçus pour un accès plus large à la douche pensée pour inclure toutes les personnes, en particulier dans les situations de mobilité réduite.

Mamparas de ducha con dobles puertas que se abren hacia el exterior, diseñadas para un acceso más amplio a la ducha pensando en la inclusión de todas las personas, en particular en situaciones de movilidad limitada.

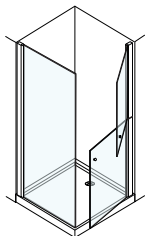

SHOWER ENCLOSURE W/ 1 DOUBLE DOOR + 1 SIDE PANEL
PAROIS DE DOUCHE A/ 1 PORTE DOUBLE + PANNEAU LATÉRAL
MAMPARA DE DUCHA C/ 1 PORTE DOBLE + 1 PANEL LATERAL

MEASUREMENTS MESURES MEDIDAS	ADJUST AJUSTER AJUSTE	TRANSPARENT TRANSPARENT TRANSPARENTE	SERIGRAPHED SERIGRAPHIE SERIGRAFADO
70 x 70 CM	68 70 CM		
80 x 80 CM	78 80 CM		
90 x 90 CM	88 90 CM		

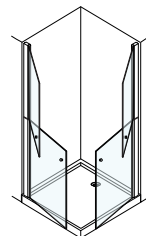

SHOWER ENCLOSURE W/ 2 DOUBLE DOORS
PAROIS DE DOUCHE A/ 2 PORTES DOUBLES
MAMPARA DE DUCHA C/ 2 PORTES DOBLES

MEASUREMENTS MESURES MEDIDAS	ADJUST AJUSTER AJUSTE	TRANSPARENT TRANSPARENT TRANSPARENTE	SERIGRAPHED SERIGRAPHIE SERIGRAFADO
70 x 70 CM	68 70 CM		
80 x 80 CM	78 80 CM		
90 x 90 CM	88 90 CM		

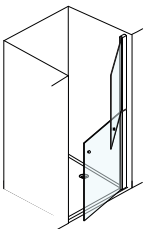

SHOWER ENCLOSURE W/ 1 DOUBLE DOOR
PAROIS DE DOUCHE A/ 1 PORTE DOUBLE
MAMPARA DE DUCHA C/ 1 PORTE DOBLE

MEASUREMENTS MESURES MEDIDAS	ADJUST AJUSTER AJUSTE	TRANSPARENT TRANSPARENT TRANSPARENTE	SERIGRAPHED SERIGRAPHIE SERIGRAFADO
70 CM	66 70 CM		
80 CM	76 80 CM		
90 CM	86 90 CM		
100 CM	96 100 CM		

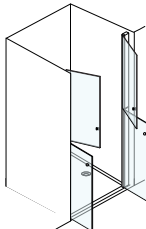

SHOWER ENCLOSURE W/ 2 DOUBLE DOORS
PAROIS DE DOUCHE A/ 2 PORTES DOUBLES
MAMPARA DE DUCHA C/ 2 PORTES DOBLES

MEASUREMENTS MESURES MEDIDAS	ADJUST AJUSTER AJUSTE	TRANSPARENT TRANSPARENT TRANSPARENTE	SERIGRAPHED SERIGRAPHIE SERIGRAFADO
70 CM	66 70 CM		
80 CM	76 80 CM		
90 CM	86 90 CM		
100 CM	96 100 CM		



80 X 80 CM

SHOWER ENCLOSURE
6MM TEMPERED GLASS
TRANSPARENT GLASS
CHROMED FRAME
REVERSIBLE
HEIGHT 190 CM

PAROIS DE DOUCHE
VERRE TREMPÉ 6MM
VERRE TRANSPARENT
PROFIL CHROMÉ
REVERSIBLE
HAUTEUR 190 CM

MAMPARA DE DUCHA
6MM VIDRIO TEMPLADO
VIDRIO TRANSPARENT
PERFILE CROMO
REVERSIBLE
ALTURA 190 CM



SHOWER ENCLOSURE W/ 2 DOORS
PAROIS DE DOUCHE A/ 2 PORTES
MAMPARA DE DUCHA C/ 2 PORTES

MEASUREMENTS MESURES MEDIDAS	ADJUST AJUSTER AJUSTE	TRANSPARENT TRANSPARENT TRANSPARENTE	SERIGRAPHED SERIGRAPHIE SERIGRAFADO
70 x 70 CM	68 70 CM		
80 x 80 CM	78 80 CM		
90 x 90 CM	88 90 CM		

SHOWER ENCLOSURE W/ 1 DOOR + 1 SIDE PANEL
PAROIS DE DOUCHE A/ 1 PORTE + PANNEAU LATÉRAL
MAMPARA DE DUCHA C/ 1 PORTE + 1 PANEL LATERAL

MEASUREMENTS MESURES MEDIDAS	ADJUST AJUSTER AJUSTE	TRANSPARENT TRANSPARENT TRANSPARENTE	SERIGRAPHED SERIGRAPHIE SERIGRAFADO
70 x 70 CM	68 70 CM		
80 x 80 CM	78 80 CM		
90 x 90 CM	88 90 CM		

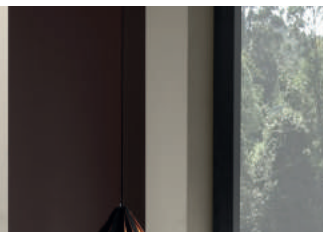
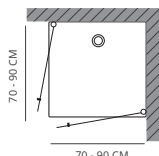
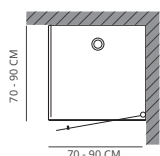

90 X 90 CM

SHOWER ENCLOSURE W/ 1 DOOR + SIDE PANEL
6MM TEMPERED GLASS
TRANSPARENT GLASS
CHROMED FRAME
REVERSIBLE
HEIGHT 190 CM

PAROIS DE DOUCHE A/ 1 PORTE + PANNEAU LATÉRAL
VERRE TREMPÉ 6MM
VERRE TRANSPARENT
PROFIL CHROMÉ
REVERSIBLE
HAUTEUR 190 CM

MAMPARA DE DUCHA C/ 1 PUERTA + 1 PANEL LATERAL
6MM VIDRIO TEMPLADO
VIDRIO TRANSPARENT
PERFILE CROMO
REVERSIBLE
ALTURA 190 CM





90 X 90 CM

SHOWER ENCLOSURE
6MM TEMPERED GLASS
SERIGRAPHED GLASS
CHROMED FRAME
CHROMED TWIN CASTORS
MAGNETIC CLOSE
REVERSIBLE
HEIGHT 190 CM

CABINE DE DOUCHE
VÈRE TREMPÉ 6MM
VERRE SÉRIGRAPHÉ
PROFIL CHROMÉ
ROULETTES DOUBLES CHROMÉS
FERMETURE MAGNETIQUE
REVERSIBLE
HAUTEUR 190 CM

MAMPARA DE DUCHA
6MM VIDRIO TEMPLADO
VIDRIO SERIGRAFADO
PERFILE CROMÉ
RUEDAS DOBLES CROMADAS
REVERSIBLE
CIERRE MAGNETICO
ALTURA 190 CM

SHOWER ENCLOSURE
CABINE DE DOUCHE // MAMPARA DE DUCHA

MEASUREMENTS MESURES MEDIDAS	TRANSPARENT TRANSPARENT TRANSPARENTE	SERIGRAPHED SÉRIGRAPHÉ SERIGRAFADO
70 x 70 CM		
70 x 90 CM		
70 x 100 CM		
70 x 110 CM		
70 x 120 CM		
70 x 130 CM		
70 x 140 CM		
70 x 150 CM		
70 x 160 CM		
75 x 75 CM		
75 x 90 CM		
75 x 100 CM		
75 x 110 CM		
75 x 120 CM		
75 x 130 CM		
75 x 140 CM		
75 x 150 CM		
75 x 160 CM		
80 x 80 CM		
80 x 90 CM		
80 x 100 CM		
80 x 110 CM		
80 x 120 CM		
80 x 130 CM		
80 x 140 CM		
80 x 150 CM		
80 x 160 CM		
90 x 90 CM		
90 x 100 CM		
90 x 110 CM		
90 x 120 CM		
90 x 130 CM		
90 x 140 CM		
90 x 150 CM		
90 x 160 CM		

SPECIAL MEASUREMENTS ADDS 25% TO THE PRICE OF THE PREVIOUS MEASURE
DES MESURES SPECIALES AJOUTE 25% SUR LE PRIX DE LA MESURE PRÉCÉDENTE
MEDIDAS ESPECIALES AÑADEN 25% AL PRECIO DE LA MEDIDA ANTERIOR

Removable door for easy cleaning
Porte amovible pour un nettoyage facile
Puerta extraíble para una fácil limpieza

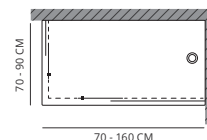



80 X 140 CM

SHOWER ENCLOSURE
6MM TEMPERED GLASS
SERIGRAPHED GLASS
CHROMED FRAME
CHROMED TWIN CASTORS
MAGNETIC CLOSE
REVERSIBLE
HEIGHT 190 CM
ADJUSTMENT OF 2CM BELOW THE MEASURES PRESENTED

CABINE DE DOUCHE
VÉRRE TREMPÉ 6MM
VERRE SÉRIGRAPHÉ
PROFIL CHROMÉ
ROULETTES DOUBLES CHROMÉS
FERMETURE MAGNETIQUE
REVERSIBLE
HAUTEUR 190 CM
AJUSTEMENT DE 2 CM AU-DESSOUS DES MESURES PRÉSENTÉES

MAMPARA DE DUCHA
6MM VIDRIO TEMPLADO
VIDRIO SERIGRAFADO
PERFILE CROMO
RUEDAS DOBLES CROMADAS
REVERSIBLE
CIERRE MAGNETICO
ALTURA 190 CM
AJUSTE DE 2 CM ABAJO DE LAS MEDIDAS PRESENTADAS

REMOVABLE DOOR FOR EASY CLEANING
PORTE AMOVIBLE POUR UN NETTOYAGE FACILE
PUERTA EXTRAÍBLE PARA UNA FÁCIL LIMPIEZA



75 X 75 CM

SHOWER ENCLOSURE
 6MM TEMPERED GLASS
 SERIGRAPHED GLASS
 CHROMED FRAME
 REVERSIBLE
 HEIGHT 185 CM
 REMOVABLE DOOR FOR EASY CLEANING
 ADJUSTMENT OF 2CM BELOW THE MEASURES PRESENTED

CABINE DE DOUCHE
 VÈRE TREMPÉ 6MM
 VERRE SÉRIGRAPHÉ
 PROFIL CHROMÉ
 REVERSIBLE
 HAUTEUR 185 CM
 PORTE DÉMONTAGE FACILE POUR LE NETTOYAGE
 AJUSTEMENT DE 2 CM AU-DESSOUS DES MESURES PRÉSENTÉES

MAMPARA DE DUCHA
 6MM VIDRIO TEMPLADO
 VIDRIO SERIGRAFADO
 PERFILE CROMO
 CIERRE MAGNETICO
 ALTURA 185 CM
 PUERTA DESMONTABLE PARA FACILITAR LA LIMPIEZA
 AJUSTE DE 2 CM ABAJO DE LAS MEDIDAS PRESENTADAS

SHOWER ENCLOSURE
 CABINE DE DOUCHE // MAMPARA DE DUCHA

MEASUREMENTS MESURES MEDIDAS	TRANSPARENT TRANSPARENT TRANSPARENTE	SERIGRAPHED SÉRIGRAPHÉ SERIGRAFADO
70 x 70 CM		
70 x 90 CM		
70 x 100 CM		
70 x 110 CM		
70 x 120 CM		
70 x 130 CM		
70 x 140 CM		
75 x 75 CM		
75 x 90 CM		
75 x 100 CM		
75 x 110 CM		
75 x 120 CM		
75 x 130 CM		
75 x 140 CM		
80 x 80 CM		
80 x 90 CM		
80 x 100 CM		
80 x 110 CM		
80 x 120 CM		
80 x 130 CM		
80 x 140 CM		
90 x 90 CM		
90 x 100 CM		
90 x 110 CM		
90 x 120 CM		
90 x 130 CM		
90 x 140 CM		

SPECIAL MEASUREMENTS ADDS 25% TO THE PRICE OF THE PREVIOUS MEASURE
 DES MESURES SPECIALES AJOUTE 25% SUR LE PRIX DE LA MESURE PRÉCÉDENTE
 EDIDAS ESPECIALES AÑADEN 25% AL PRECIO DE LA MEDIDA ANTERIOR

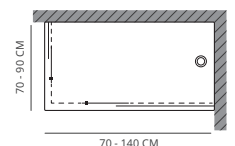

80 X 80 CM

SHOWER ENCLOSURE
 6MM TEMPERED GLASS
 TRANSPARENT GLASS
 CHROMED FRAME
 REVERSIBLE
 HEIGHT 185 CM
 REMOVABLE DOOR FOR EASY CLEANING
 ADJUSTMENT OF 2CM BELOW THE MEASURES PRESENTED

CABINE DE DOUCHE
 VÉRRE TREMPÉ 6MM
 VÉRRE TRANSPARENT
 PROFIL CHROMÉ
 REVERSIBLE
 HAUTEUR 185 CM
 PORTE DÉMONTAGE FACILE POUR LE NETTOYAGE
 AJUSTEMENT DE 2 CM AU-DESSOUS DES MESURES PRÉSENTÉES

MAMPARA DE DUCHA
 6MM VIDRIO TEMPLADO
 VIDRIO TRANSPARENTE
 PERFIL CROMO
 CIERRE MAGNETICO
 ALTURA 185 CM
 PUERTA DESMONTABLE PARA FACILITAR LA LIMPIEZA
 AJUSTE DE 2 CM ABAJO DE LAS MEDIDAS PRESENTADAS

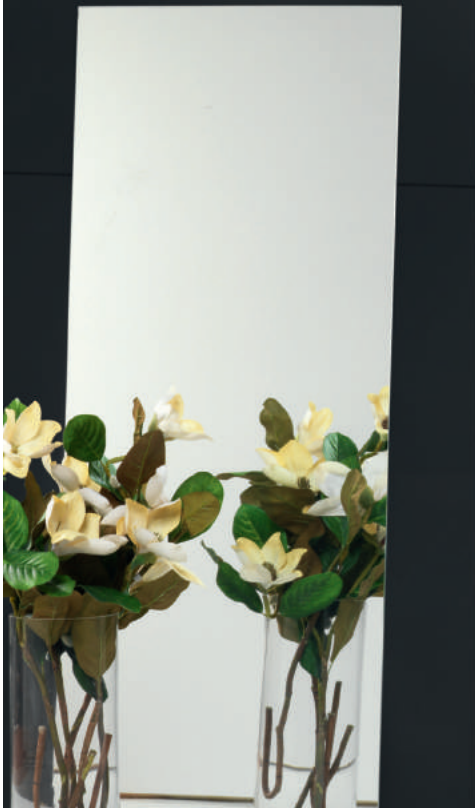



80 X 80 CM

WHITE FRAME
PROFIL BLANC
PERFILE BLANCO

SHOWER ENCLOSURE
3 MM TEMPERED GLASS
SERIGRAPHED GLASS
WHITE FRAME
MAGNETIC CLOSE
REVERSIBLE
HEIGHT 185 CM

CABINE DE DOUCHE
VERRE TREMPÉ 3 MM
VERRE SÉRIGRAPHIÉ
PROFIL BLANC
FERMETURE MAGNETIQUE
HAUTEUR 185 CM

MAMPARA DE DUCHA
3 MM VIDRIO TEMPLADO
VIDRIO SERIGRAFADO
PERFILE BLANCO
CIERRE MAGNÉTICO
REVERSIBLE
ALTURA 185 CM

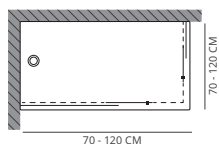

SHOWER ENCLOSURE
CABINE DE DOUCHE // MAMPARA DE DUCHA

MEASUREMENTS MESURES MEDIDAS	ADJUST AJUSTER AJUSTE	WHITE FRAME PROFIL BLANC PERFILE BLANCO		METALLIC FRAME PROFIL METALLIQUE PERFILE METÁLICO	
		TRANSPARENT TRANSPARENT TRANSPARENTE	SERIGRAPHED SÉRIGRAPHIÉ SERIGRAFADO	TRANSPARENT TRANSPARENT TRANSPARENTE	SERIGRAPHED SÉRIGRAPHIÉ SERIGRAFADO
70 x 70 CM	60 70 CM				
70 x 80 CM	60 70 - 70 80 CM				
70 x 90 CM	60 70 - 80 90 CM				
70 x 100 CM	60 70 - 90 100 CM				
70 x 110 CM	60 70 - 100 110 CM				
70 x 120 CM	60 70 - 110 120 CM				
80 x 80 CM	70 80 CM				
80 x 90 CM	70 80 - 80 90 CM				
80 x 100 CM	70 80 - 90 100 CM				
80 x 110 CM	70 80 - 100 110 CM				
80 x 120 CM	70 80 - 110 120 CM				
90 x 90 CM	80 90 CM				
90 x 100 CM	80 90 - 90 100 CM				
90 x 110 CM	80 90 - 100 110 CM				
90 x 120 CM	80 90 - 110 120 CM				
100 x 100 CM	90 100 CM				
100 x 110 CM	90 100 - 100 110 CM				
100 x 120 CM	90 100 - 110 120 CM				
110 x 110 CM	100 110 CM				
110 x 120 CM	100 110 - 110 120 CM				
120 x 120 CM	110 120 CM				

80 X 120 CM

METALIC FRAME
PROFIL METALIQUE
PERFILE METÁLICO

SHOWER ENCLOSURE
3 MM TEMPERED GLASS
TRANSPARENT GLASS
METALIC FRAME
MAGNETIC CLOSE
REVERSIBLE
HEIGHT 185 CM

CABINE DE DOUCHE
VERRE TREMPÉ 3 MM
VERRE TRANSPARENT
PROFIL METALIQUE
FERMETURE MAGNETIQUE
HAUTEUR 185 CM

MAMPARA DE DUCHA
3 MM VIDRIO TEMPLADO
VIDRIO TRANSPARENTE
PERFILE METÁLICO
CIERRE MAGNÉTICO
REVERSIBLE
ALTURA 185 CM



bellian
ESMERALDA



90 X 90 CM

SHOWER ENCLOSURE
 6 MM TEMPERED GLASS
 TRANSPARENT GLASS
 CHROMED FRAME
 CHROMED TWIN CASTORS
 MAGNETIC CLOSE
 REVERSIBLE
 HEIGHT 190 CM
 REMOVABLE DOOR FOR EASY CLEANING

CABINE DE DOUCHE
 VERRE TREMPÉ 6 MM
 VERRE SÉRIGRAPHIÉ
 PROFIL CHROMÉ
 ROULETTES DOUBLES CHROMÉS
 FERMETURE MAGNETIQUE
 REVERSIBLE
 HAUTEUR 190 CM
 PORTE DÉMONTAGE FACILE POUR LE NETTOYAGE

MAMPARA DE DUCHA
 6 MM VIDRIO TEMPLADO
 VIDRIO SERIGRAFADO
 PERFIL CROMO
 RUEDAS DOBLES CROMADAS
 CIERRE MAGNÉTICO
 REVERSIBLE
 ALTURA 190 CM
 PUERTA DESMONTABLE PARA FACILITAR LA LIMPIEZA

SHOWER ENCLOSURE
 CABINE DE DOUCHE // MAMPARA DE DUCHA

MEASUREMENTS
 MESURES
 MEDIDAS
 80 x 80 CM
 90 x 90 CM

TRANSPARENT
 TRANSPARENT
 TRANSPARENTE

SERIGRAPHIED
 SÉRIGRAPHIÉ
 SERIGRAFADO

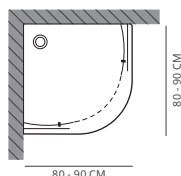

Removable door for easy cleaning
 Porte amovible pour un nettoyage facile
 Puerta extraíble para una fácil limpieza

80 X 80 CM

SHOWER ENCLOSURE
 5 MM TEMPERED GLASS
 TRANSPARENT GLASS
 CHROMED FRAME
 MAGNETIC CLOSE
 REVERSIBLE
 HEIGHT 185 CM
 REMOVABLE DOOR FOR EASY CLEANING

CABINE DE DOUCHE
 VERRE TREMPÉ 5 MM
 VERRE TRANSPARENT
 PROFIL CHROMÉ
 FERMETURE MAGNETIQUE
 REVERSIBLE
 HAUTEUR 185 CM
 PORTE DÉMONTAGE FACILE POUR LE NETTOYAGE

MAMPARA DE DUCHA
 5 MM VIDRIO TEMPLADO
 VIDRIO TRANSPARENTE
 PERFILE CROMO
 CIERRE MAGNÉTICO
 REVERSIBLE
 ALTURA 185 CM
 PUERTA DESMONTABLE PARA FACILITAR LA LIMPIEZA

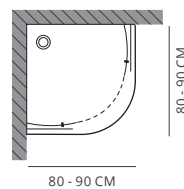
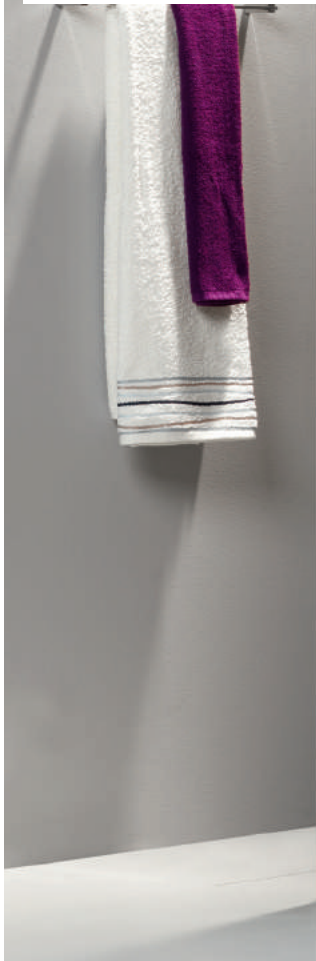
SHOWER ENCLOSURE
 CABINE DE DOUCHE // MAMPARA DE DUCHA

 MEASUREMENTS
 MESURES

 80 x 80 CM
 90 x 90 CM

 TRANSPARENT
 TRANSPARENTE

 SERIGRAPHED
 SERIGRAFADO



90 X 90 CM

SHOWER ENCLOSURE
6 MM TEMPERED GLASS
TRANSPARENT GLASS
CHROMED FRAME
REVERSIBLE
HEIGHT 190 CM

CABINE DE DOUCHE
VERRE TREMPÉ 6 MM
VERRE TRANSPARENT
PROFIL CHROMÉ
REVERSIBLE
HAUTEUR 190 CM

MAMPARA DE DUCHA
6 MM VIDRIO TEMPLADO
VIDRIO TRANSPARENTE
PERFILE CROMO
REVERSIBLE
ALTURA 190 CM

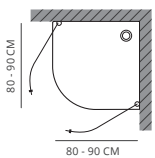

SHOWER ENCLOSURE
CABINE DE DOUCHE // MAMPARA DE DUCHA

MEASUREMENTS MESURES MEDIDAS	TRANSPARENT TRANSPARENT TRANSPARENTE	SERIGRAPHED SERIGRAPHIE SERIGRAFADO
80 x 80 CM		
90 x 90 CM		





70 CM

SHOWER ENCLOSURE W/ 2 DOORS
 6 MM TEMPERED GLASS
 TRANSPARENT GLASS
 CHROMED FRAME
 REVERSIBLE
 HEIGHT 190 CM

PAROIS DE DOUCHE A/ 2 PORTES
 VERRE TREMPÉ 6 MM
 VERRE TRANSPARENT
 PROFIL CHROMÉ
 REVERSIBLE
 HAUTEUR 190 CM

MAMPARA DE DUCHA C/ 2 PUERTAS
 6 MM VIDRIO TEMPLADO
 VIDRIO TRANSPARENTE
 PERFIL CROMO
 REVERSIBLE
 ALTURA 190 CM

FRONT PANEL WITH 2 DOORS
 PANNEAU FRONTAL AVEC 2 PORTES
 PANEL FRONTAL CON 2 PUERTAS

MEASUREMENTS MESURES MEDIDAS	ADJUST AJUSTER AJUSTE	TRANSPARENT TRANSPARENT TRANSPARENTE	SERIGRAPHED SERIGRAPHÉ SERIGRAFADO
70 CM	70 75 CM		
80 CM	80 85 CM		
90 CM	90 95 CM		
100 CM	100 105 CM		

FRONT PANEL WITH 1 DOOR
 PANNEAU FRONTAL AVEC 1 PORTE
 PANEL FRONTAL CON 1 PUERTA

MEASUREMENTS MESURES MEDIDAS	ADJUST AJUSTER AJUSTE	TRANSPARENT TRANSPARENT TRANSPARENTE	SERIGRAPHED SERIGRAPHÉ SERIGRAFADO
70 CM	70 75 CM		
80 CM	80 85 CM		
90 CM	90 95 CM		

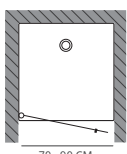

70 - 90 CM

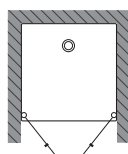

70 - 100 CM

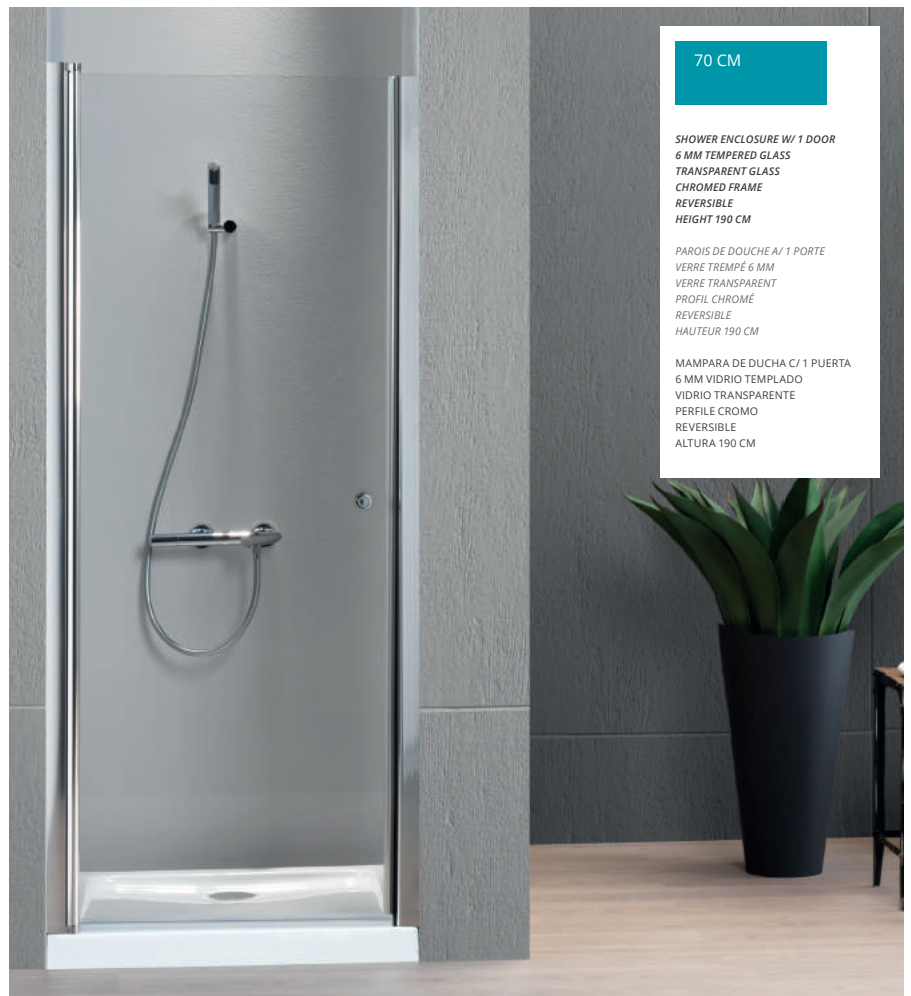

70 CM

SHOWER ENCLOSURE W/ 1 DOOR
 6 MM TEMPERED GLASS
 TRANSPARENT GLASS
 CHROMED FRAME
 REVERSIBLE
 HEIGHT 190 CM

PAROIS DE DOUCHE A/ 1 PORTE
 VERRE TREMPÉ 6 MM
 VERRE TRANSPARENT
 PROFIL CHROMÉ
 REVERSIBLE
 HAUTEUR 190 CM

MAMPARA DE DUCHA C/ 1 PUERTA
 6 MM VIDRIO TEMPLADO
 VIDRIO TRANSPARENTE
 PERFIL CROMO
 REVERSIBLE
 ALTURA 190 CM



200 CM

SHOWER ENCLOSURE W/ 2 DOORS + 2 FIXED PANELS
6 MM TEMPERED GLASS
SERIGRAPHED GLASS
CHROMED FRAME
MAGNETIC CLOSE
HEIGHT 190 CM

PAROIS DE DOUCHE A/ 2 PORTES + 2 PANNEAUX FIXES
VERRE TREMPÉ 6 MM
VERRE TRANSPARENT
PROFIL CHROMÉ
FERMETURE MAGNETIQUE
HAUTEUR 190 CM

MAMPARA DE DUCHA C/ 2 PUERTAS + 2 PANELS FIJOS
6 MM VIDRIO TEMPLADO
VIDRIO TRANSPARENTE
PERFILE CROMO
CIERRE MAGNÉTICO
ALTURA 190 CM

FRONT PANEL // PANNEAU FRONTAL // PANEL FRONTAL

MEASUREMENTS MESURES MEDIDAS	ADJUST AJUSTER AJUSTE	1 DOOR X 1 FIXED PANEL 1 PORTE + 1 PANNEAU FIXE 1 PUERTA + 1 PANEL FIJO		2 DOORS X 2 FIXED PANELS 2 PORTES + 2 PANNEAUX FIXES 2 PUERTAS + 2 PANELES FIJOS	
		TRANSPARENT TRANSPARENTE	SERIGRAPHED SERIGRAFADO	TRANSPARENT TRANSPARENTE	SERIGRAPHED SERIGRAFADO
90 CM	86 91 CM			-	-
95 CM	91 96 CM			-	-
100 CM	96 101 CM			-	-
105 CM	101 106 CM			-	-
110 CM	106 111 CM			-	-
115 CM	111 116 CM			-	-
120 CM	116 121 CM			-	-
125 CM	121 126 CM			-	-
130 CM	126 131 CM			-	-
135 CM	131 136 CM			-	-
140 CM	136 141 CM				
145 CM	141 146 CM				
150 CM	146 151 CM				
155 CM	151 156 CM				
160 CM	156 161 CM				
165 CM	161 166 CM	-	-		
170 CM	166 171 CM	-	-		
175 CM	171 176 CM	-	-		
180 CM	176 181 CM	-	-		
185 CM	181 186 CM	-	-		
190 CM	186 191 CM	-	-		
195 CM	191 196 CM	-	-		
200 CM	196 201 CM	-	-		

SIDE PANEL // PANNEAU LATÉRAL // PANEL LATERAL

MEASUREMENTS MESURES MEDIDAS	ADJUST AJUSTER AJUSTE	TRANSPARENT TRANSPARENTE	SERIGRAPHED SERIGRAFADO
70 CM	68 70 CM		
75 CM	73 75 CM		
80 CM	78 80 CM		
90 CM	88 90 CM		

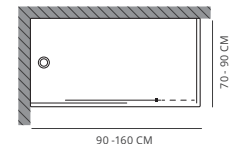
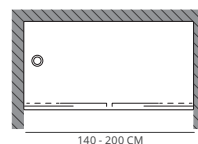

ON THE OPTION WITH SIDE: THE FRONT ADJUSTMENT REDUCES 1 CM. SPECIAL MEASUREMENTS ADDS 25% TO THE PRICE OF THE PREVIOUS MEASURE.
DANS L'OPTION AVEC LATÉRALE: L'AJUSTEMENT DOIT REDUIRE 1 CM. DES MESURES SPÉCIALES AJOUTE 25% SUR LE PRIX LA MESURE PRÉCÉDENT.
EM LA OPCIÓN CON LATERAL: EL AJUSTE FRONTAL REDUCE DE 1 CM. MEDIDAS ESPECIALES AÑADEN 25% AL PRECIO DE LA MEDIDA ANTERIOR.



160 x 80 CM

SHOWER ENCLOSURE W/ 1 DOOR + 1 FIXED PANEL + 1 SIDE PANEL
6 MM TEMPERED GLASS
SERIGRAPHED GLASS
CHROMED FRAME
MAGNETIC CLOSE
HEIGHT 190 CM

PAROIS DE DOUCHE A/ 1 PORTE + 1 PANNEAU FIXE + 1 PANNEAU LATÉRAL
VERRE TREMPÉ 6 MM
VERRE TRANSPARENT
PROFIL CHROME
FERMETURE MAGNETIQUE
HAUTEUR 190 CM

MAMPARA DE DUCHA C/ 1 PUERTA + 1 PANEL FIJO + 1 PANEL LATERAL
6 MM VIDRIO TEMPLADO
VIDRIO TRANSPARENTE
PERFILE CROMO
CIERRE MAGNÉTICO
ALTURA 190 CM

bellian

GILDA

REMOVABLE DOOR FOR EASY CLEANING
PORTE AMOVIBLE POUR UN NETTOYAGE FACILE
PUERTA EXTRAÍBLE PARA UNA FÁCIL LIMPIEZA

170 CM

SHOWER ENCLOSURE W/ 2 DOORS + 2 FIXED PANELS
5 MM TEMPERED GLASS
SERIGRAPHED GLASS
CHROMED FRAME
REVERSIBLE
HEIGHT 185 CM
REMOVABLE DOOR FOR EASY CLEANING

PAROIS DE DOUCHE A/ 2 PORTES + 2 PANNEAUX FIXES
VERRE TREMPÉ 5 MM
VERRE SÉRIGRAPHÉ
PROFIL CHROMÉ
REVERSIBLE
HAUTEUR 185 CM
PORTE DÉMONTAGE FACILE POUR LE NETTOYAGE

MAMPARA DE DUCHA 2 PUERTAS + 2 PANELES FIJOS
5 MM VIDRIO TEMPLADO
VIDRIO SERIGRAFADO
PERFILE CROMO
REVERSIBLE
ALTURA 185 CM
PUERTA DESMONTABLE PARA FACILITAR LA LIMPIEZA



FRONT PANEL W/ 2 DOORS + 2 FIXED PANELS
PANNEAU FRONTAL A/ 2 PORTES + 2 PANNEAUX FIXES
PANEL FRONTAL C/ 2 PUERTAS + 2 PANELES FIJOS

MEASUREMENTS MESURES MEDIDAS	ADJUST AJUSTE AJUSTE	TRANSPARENT TRANSPARENT TRANSPARENTE	SERIGRAPHED SÉRIGRAPHÉ SERIGRAFADO
140 CM	136 140 CM		
145 CM	141 145 CM		
150 CM	146 150 CM		
155 CM	151 155 CM		
160 CM	156 160 CM		
165 CM	161 165 CM		
170 CM	166 170 CM		
175 CM	171 175 CM		
180 CM	176 180 CM		

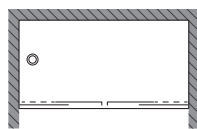

140 - 180 CM

SPECIAL MEASUREMENTS ADDS 25% TO THE PRICE OF THE PREVIOUS MEASURE.
DES MESURES SPECIALES AJOUTE 25% SUR LE PRIX LA MESURE PRÉCÉDENT.
MEDIDAS ESPECIALES AÑADEN 25% AL PRECIO DE LA MEDIDA ANTERIOR.

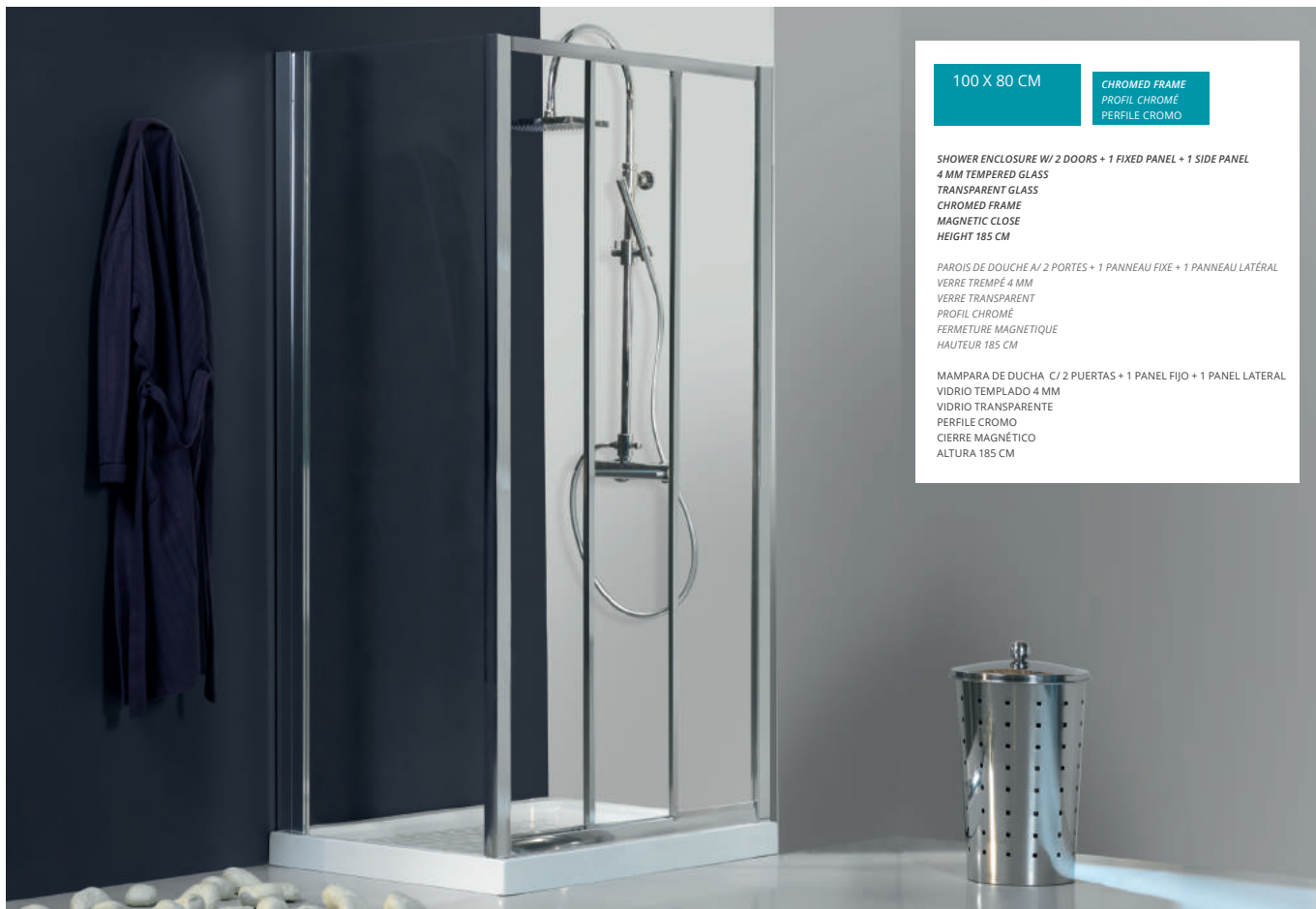

100 X 80 CM

CHROMED FRAME
PROFIL CHROMÉ
PERFILE CROMO

SHOWER ENCLOSURE W/ 2 DOORS + 1 FIXED PANEL + 1 SIDE PANEL
4 MM TEMPERED GLASS
TRANSPARENT GLASS
CHROMED FRAME
MAGNETIC CLOSE
HEIGHT 185 CM

PAROIS DE DOUCHE A/ 2 PORTES + 1 PANNEAU FIXE + 1 PANNEAU LATÉRAL
VERRE TREMPÉ 4 MM
VERRE TRANSPARENT
PROFIL CHROMÉ
FERMETURE MAGNETIQUE
HAUTEUR 185 CM

MAMPARA DE DUCHA C/ 2 PUERTAS + 1 PANEL FIJO + 1 PANEL LATERAL
VIDRIO TEMPLADO 4 MM
VIDRIO TRANSPARENTE
PERFILE CROMO
CIERRE MAGNÉTICO
ALTURA 185 CM

FRONT PANEL WITH 2 DOORS + 1 FIXED PANEL
PANNEAU FRONTL AVEC 2 PORTES + 1 PANNEAU FIXE
PANEL FRONTAL CON 2 PUERTAS + 1 PANEL FIJO

MEASUREMENTS MESURES MEDIDAS	ADJUST AJUSTER AJUSTE	WHITE FRAME PROFIL BLANC PERFILE BLANCO		METALIC FRAME PROFIL METALLIQUE PERFILE METÁLICO	
		TRANSPARENT TRANSPARENT TRANSPARENTE	SERIGRAPHED SERIGRAPHÉ SERIGRAFADO	TRANSPARENT TRANSPARENT TRANSPARENTE	SERIGRAPHED SERIGRAPHÉ SERIGRAFADO
80 CM	77 82 CM				
85 CM	82 87 CM				
90 CM	87 92 CM				
95 CM	92 97 CM				
100 CM	97 102 CM				
105 CM	102 107 CM				
110 CM	107 112 CM				
115 CM	112 117 CM				
120 CM	117 122 CM				
125 CM	122 127 CM				
130 CM	127 132 CM				
135 CM	132 137 CM				
140 CM	137 142 CM				
145 CM	142 147 CM				
150 CM	147 152 CM				
155 CM	152 157 CM				
160 CM	157 162 CM				

SIDE PANEL // PANNEAU LATÉRAL // PANEL LATERAL

MEASUREMENTS MESURES MEDIDAS	ADJUST AJUSTER AJUSTE	WHITE FRAME PROFIL BLANC PERFILE BLANCO		METALIC FRAME PROFIL METALLIQUE PERFILE METÁLICO	
		TRANSPARENT TRANSPARENT TRANSPARENTE	SERIGRAPHED SERIGRAPHÉ SERIGRAFADO	TRANSPARENT TRANSPARENT TRANSPARENTE	SERIGRAPHED SERIGRAPHÉ SERIGRAFADO
70 CM	67,5 70 CM				
75 CM	72,5 75 CM				
80 CM	77,5 80 CM				
90 CM	87,5 90 CM				

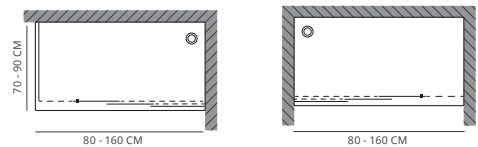

SPECIAL MEASUREMENTS ADDS 25% TO THE PRICE OF THE PREVIOUS MEASURE.
DES MESURES SPECIALES AJOUTE 25% SUR LE PRIX LA MESURE PRÉCÉDENT.
MEDIDAS ESPECIALES AÑADEN 25% AL PRECIO DE LA MEDIDA ANTERIOR.



140 CM

WHITE FRAME
PROFIL BLANC
PERFILE BLANCO

SHOWER ENCLOSURE W/ 2 DOORS + 1 FIXED PANEL
4 MM TEMPERED GLASS
SERIGRAPHED GLASS
WHITE FRAME
MAGNETIC CLOSE
HEIGHT 185 CM

PAROIS DE DOUCHE A/ 2 PORTES + 1 PANNEAU FIXE
VERRE TREMPÉ 4 MM
VERRE TRANSPARENT
PROFIL BLANC
FERMETURE MAGNETIQUE
HAUTEUR 185 CM

MAMPARA DE DUCHA C/ 2 PUERTAS + 1 PANEL FIJO
VIDRIO TEMPLADO 4 MM
VIDRIO TRANSPARENTE
PERFILE BLANC
CIERRE MAGNÉTICO
ALTURA 185 CM



200 CM **METALIC FRAME**
PROFIL METALIQUE
PERFILE METÁLICO

SHOWER ENCLOSURE W/ 2 DOORS + 2 FIXED PANELS
3 MM TEMPERED GLASS
TRANSPARENT GLASS
METALIC FRAME
MAGNETIC CLOSE
HEIGHT 185 CM

PAROIS DE DOUCHE A/ 2 PORTES + 2 PANNEAUX FIXES
VERRE TREMPÉ 3 MM
VERRE TRANSPARENT
PROFIL METALIQUE
FERMETURE MAGNETIQUE
HAUTEUR 185 CM

MAMPARA DE DUCHA C/ 2 PUERTAS + 2 PANELES FIJOS VIDRIO
TEMPLADO 3 MM
VIDRIO TRANSPARENTE
PERFILE METÁLICO
CIERRE MAGNÉTICO
ALTURA 185 CM



FRONT PANEL WITH 2 DOORS + 2 FIXED PANELS
PANNEAU FRONTL AVEC 2 PORTES + 2 PANNEAUX FIXES
PANEL FRONTAL CON 2 PUERTAS + 2 PANELES FIJOS

MEASUREMENTS MESURES MEDIDAS	ADJUST AJUSTER AJUSTE	WHITE FRAME PROFIL BLANC PERFILE BLANCO		METALIC FRAME PROFIL METALIQUE PERFILE METÁLICO	
		TRANSPARENT TRANSPARENTE	SERIGRAPHED SERIGRAPHIE SERIGRAFADO	TRANSPARENT TRANSPARENTE	SERIGRAPHED SERIGRAPHIE SERIGRAFADO
140 CM	137 142 CM				
145 CM	142 147 CM				
150 CM	147 152 CM				
155 CM	152 157 CM				
160 CM	157 162 CM				
165 CM	162 167 CM				
170 CM	167 172 CM				
175 CM	172 177 CM				
180 CM	177 182 CM				
185 CM	182 187 CM				
190 CM	187 192 CM				
195 CM	192 197 CM				
200 CM	197 202 CM				

SIDE PANEL // PANNEAU LATÉRAL // PANEL LATERAL

MEASUREMENTS MESURES MEDIDAS	ADJUST AJUSTER AJUSTE	WHITE FRAME PROFIL BLANC PERFILE BLANCO		METALIC FRAME PROFIL METALIQUE PERFILE METÁLICO	
		TRANSPARENT TRANSPARENTE	SERIGRAPHED SERIGRAPHIE SERIGRAFADO	TRANSPARENT TRANSPARENTE	SERIGRAPHED SERIGRAPHIE SERIGRAFADO
70 CM	67,5 70 CM				
75 CM	72,5 75 CM				
80 CM	77,5 80 CM				
90 CM	87,5 90 CM				

200 CM **WHITE FRAME**
PROFIL BLANC
PERFILE BLANCO

SHOWER ENCLOSURE W/ 2 DOORS + 2 FIXED PANELS
3 MM TEMPERED GLASS
SERIGRAPHED GLASS
WHITE FRAME
MAGNETIC CLOSE
HEIGHT 185 CM

PAROIS DE DOUCHE A/ 2 PORTES + 2 PANNEAUX FIXES
VERRE TREMPÉ 3 MM
VERRE SÉRIGRAPHIÉ
PROFIL BLANC
FERMETURE MAGNETIQUE
HAUTEUR 185 CM

MAMPARA DE DUCHA C/ 2 PUERTAS + 2 PANELES FIJOS VIDRIO
TEMPLADO 3 MM
VIDRIO SERIGRAFADO
PERFILE BLANCO
CIERRE MAGNÉTICO
ALTURA 185 CM

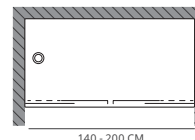



90 CM

METALIC FRAME
PROFIL METALLIQUE
PERFILE METÁLICO

SHOWER ENCLOSURE W/ 1 DOOR + 1 FIXED PANEL
3 MM TEMPERED GLASS
TRANSPARENT GLASS
METALIC FRAME
MAGNETIC CLOSE
HEIGHT 185 CM

PAROIS DE DOUCHE A/ 1 PORTE + 1 PANNEAU FIXE
VERRE TREMPÉ 3 MM
VERRE TRANSPARENT
PROFIL METALLIQUE
FERMETURE MAGNETIQUE
HAUTEUR 185 CM

MAMPARA DE DUCHA C/ 1 PUERTA + 1 PANEL FIJO
VIDRIO TEMPLADO 3 MM
VIDRIO TRANSPARENTE
PERFILE METÁLICO
CIERRE MAGNÉTICO
ALTURA 185 CM

FRONT PANEL WITH 1 DOOR + 1 FIXED PANEL
PANNEAU FRONTL AVEC 1 PORTE + 1 PANNEAU FIXE
PANEL FRONTAL CON 1 PUERTA + 1 PANEL FIJO

MEASUREMENTS MESURES MEDIDAS	ADJUST AJUSTER AJUSTE	WHITE FRAME PROFIL BLANC PERFILE BLANCO		METALIC FRAME PROFIL METALLIQUE PERFILE METÁLICO	
		TRANSPARENT TRANSPARENT TRANSPARENTE	SERIGRAPHED SÉRIGRAPHIÉ SERIGRAFADO	TRANSPARENT TRANSPARENT TRANSPARENTE	SERIGRAPHED SÉRIGRAPHIÉ SERIGRAFADO
90 CM	87 92 CM				
95 CM	92 97 CM				
100 CM	97 102 CM				
105 CM	102 107 CM				
110 CM	107 112 CM				
115 CM	112 117 CM				
120 CM	117 122 CM				
125 CM	122 127 CM				
130 CM	127 132 CM				
135 CM	132 137 CM				
140 CM	137 142 CM				
145 CM	142 147 CM				
150 CM	147 152 CM				
155 CM	152 157 CM				
160 CM	157 162 CM				

SIDE PANEL // PANNEAU LATÉRAL // PANEL LATERAL

MEASUREMENTS MESURES MEDIDAS	ADJUST AJUSTER AJUSTE	WHITE FRAME PROFIL BLANC PERFILE BLANCO		METALIC FRAME PROFIL METALLIQUE PERFILE METÁLICO	
		TRANSPARENT TRANSPARENT TRANSPARENTE	SERIGRAPHED SÉRIGRAPHIÉ SERIGRAFADO	TRANSPARENT TRANSPARENT TRANSPARENTE	SERIGRAPHED SÉRIGRAPHIÉ SERIGRAFADO
70 CM	67,5 70 CM				
75 CM	72,5 75 CM				
80 CM	77,5 80 CM				
90 CM	87,5 90 CM				

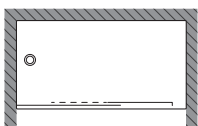

90 - 160 CM



90 CM

WHITE FRAME
PROFIL BLANC
PERFILE BLANCO

SHOWER ENCLOSURE W/ 1 DOOR + 1 FIXED PANEL
3 MM TEMPERED GLASS
SERIGRAPHED GLASS
WHITE FRAME
MAGNETIC CLOSE
HEIGHT 185 CM

PAROIS DE DOUCHE A/ 1 PORTE + 1 PANNEAU FIXE
VERRE TREMPÉ 3 MM
VERRE SÉRIGRAPHIÉ
PROFIL BLANC
FERMETURE MAGNETIQUE
HAUTEUR 185 CM

MAMPARA DE DUCHA C/ 1 PUERTA + 1 PANEL FIJO
VIDRIO TEMPLADO 3 MM
VIDRIO SERIGRAFADO
PERFILE BLANCO
CIERRE MAGNÉTICO
ALTURA 185 CM



160 x 70 CM

BATH ENCLOSURE W/ 1 DOOR + 1 FIXED PANEL + 1 SIDE PANEL
6 MM TEMPERED GLASS
TRANSPARENT GLASS
CHROMED FRAME
MAGNETIC CLOSE
HEIGHT 150 CM

PARE-BAIGNOIRE A/ 1 PORTE + 1 PANNEAU FIXE + 1 PANNEAU LATÉRAL
VERRE TREMPÉ 6 MM
VERRE TRANSPARENT
PROFIL CHROMÉ
FERMETURE MAGNETIQUE
HAUTEUR 150 CM

MAMPARA DE BAÑO C/ 1 PUERTA + 1 PANEL FIJO + 1 PANEL LATERAL
VIDRIO TEMPLADO 6 MM
VIDRIO TRANSPARENTE
PERFILE CROMO
CIERRE MAGNÉTICO
ALTURA 150 CM

FRONT PANEL WITH 2 DOORS + 2 FIXED PANELS
PANNEAU FRONTL AVEC 2 PORTES + 2 PANNEAUX FIXES
PANEL FRONTAL CON 2 PUERTAS + 2 PANELES FIJOS

MEASUREMENTS MESURES MEDIDAS	ADJUST AJUSTER AJUSTE	1 DOOR + 1 FIXED PANEL 1 PORTE + 1 PANNEAU FIXE 1 PUERTA + 1 PANEL FIJO		2 DOORS + 2 FIXED PANELS 2 PORTES + 2 PANNEAUX FIXES 2 PUERTAS + 2 PANELES FIJOS	
		TRANSPARENT TRANSPARENT TRANSPARENTE	SERIGRAPHED SERIGRAPHÉ SERIGRAFADO	TRANSPARENT TRANSPARENT TRANSPARENTE	SERIGRAPHED SERIGRAPHÉ SERIGRAFADO
140 CM	137 141 CM				
145 CM	142 146 CM				
150 CM	147 151 CM				
155 CM	152 156 CM				
160 CM	157 161 CM				
165 CM	162 166 CM				
170 CM	167 171 CM				
175 CM	172 176 CM				
180 CM	177 181 CM				
185 CM	182 186 CM				
190 CM	187 191 CM				
195 CM	192 196 CM				
200 CM	197 201 CM				

SIDE PANEL // PANNEAU LATÉRAL // PANEL LATERAL

MEASUREMENTS MESURES MEDIDAS	ADJUST AJUSTER AJUSTE	TRANSPARENT TRANSPARENT TRANSPARENTE	SERIGRAPHED SERIGRAPHÉ SERIGRAFADO
70 CM	68 70 CM		
75 CM	73 75 CM		
80 CM	78 80 CM		

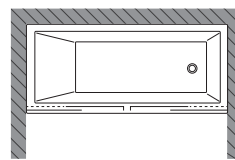

140 - 200 CM

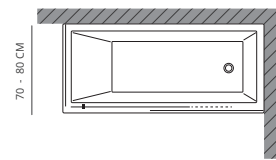

140 - 200 CM

160 CM

BATH ENCLOSURE W/ 2 DOORS + 2 FIXED PANELS
 6 MM TEMPERED GLASS
 SERIGRAPHED GLASS
 CHROMED FRAME
 MAGNETIC CLOSE
 HEIGHT 150 CM

PARE-BAIGNOIRE A/ 2 PORTES + 2 PANNEAUX FIXES
 VERRE TREMPÉ 6 MM
 VERRE SÉRIGRAPHIÉ
 PROFIL CHROMÉ
 FERMETURE MAGNETIQUE
 HAUTEUR 150 CM

MAMPARA DE BAÑO C/ 2 PUERTAS + 2 PANELES FIJOS
 VIDRIO TEMPLADO 6 MM
 VIDRIO SERIGRAFADO
 PERFILE CROMO
 CIERRE MAGNÉTICO
 ALTURA 150 CM





160 x 70 CM **CHROMED FRAME**
PROFIL CHROMÉ
PERFILE CROMO

BATH ENCLOSURE W/ 2 DOORS + 1 FIXED PANEL + 1 SIDE PANEL
4 MM TEMPERED GLASS
TRANSPARENT GLASS
CHROMED FRAME
MAGNETIC CLOSE
HEIGHT 140 CM

PARE-BAIGNOIRE A/ 2 PORTES + 1 PANNEAU FIXE + 1 PANNEAU LATÉRAL
VERRE TREMPÉ 4 MM
VERRE TRANSPARENT
PROFIL CHROMÉ
FERMETURE MAGNETIQUE
HAUTEUR 140 CM

MAMPARA DE BAÑO C/ 2 PUERTAS + 1 PANEL FIJO + 1 PANEL LATÉRAL
VIDRIO TEMPLADO 4 MM
VIDRIO TRANSPARENTE
PERFILE CROMO
CIERRE MAGNÉTICO
ALTURA 140 CM



160 CM **WHITE FRAME**
PROFIL BLANC
PERFILE BLANCO

BATH ENCLOSURE W/ 2 DOORS + 1 FIXED PANEL + 1 SIDE PANEL
4 MM TEMPERED GLASS
TRANSPARENT GLASS
CHROMED FRAME
MAGNETIC CLOSE
HEIGHT 140 CM

PARE-BAIGNOIRE A/ 2 PORTES + 1 PANNEAU FIXE + 1 PANNEAU LATÉRAL
VERRE TREMPÉ 4 MM
VERRE TRANSPARENT
PROFIL CHROMÉ
FERMETURE MAGNETIQUE
HAUTEUR 140 CM

MAMPARA DE BAÑO C/ 2 PUERTAS + 1 PANEL FIJO + 1 PANEL LATÉRAL
VIDRIO TEMPLADO 4 MM
VIDRIO TRANSPARENTE
PERFILE CROMO
CIERRE MAGNÉTICO
ALTURA 140 CM

FRONT PANEL WITH 2 DOORS + 1 FIXED PANEL
PANNEAU FRONTL AVEC 2 PORTES + 1 PANNEAU FIXE
PANEL FRONTAL CON 2 PUERTAS + 1 PANEL FIJO

MEASUREMENTS MESURES MEDIDAS	ADJUST AJUSTER AJUSTE	WHITE FRAME PROFIL BLANC PERFILE BLANCO		CHROMED FRAME PROFIL CHROMÉ PERFILE CROMO	
		TRANSPARENT TRANSPARENT TRANSPARENTE	SERIGRAPHED SERIGRAPHIE SERIGRAFADO	TRANSPARENT TRANSPARENT TRANSPARENTE	SERIGRAPHED SERIGRAPHIE SERIGRAFADO
150 CM	147	152	152		
155 CM	152	157	157		
160 CM	157	162	162		
165 CM	162	167	167		
170 CM	167	172	172		
175 CM	172	177	177		
180 CM	177	182	182		
185 CM	182	187	187		
190 CM	187	192	192		
195 CM	192	197	197		
200 CM	197	202	202		

SIDE PANEL // PANNEAU LATÉRAL // PANEL LATÉRAL

MEASUREMENTS MESURES MEDIDAS	ADJUST AJUSTER AJUSTE	WHITE FRAME PROFIL BLANC PERFILE BLANCO		CHROMED FRAME PROFIL CHROMÉ PERFILE CROMO	
		TRANSPARENT TRANSPARENT TRANSPARENTE	SERIGRAPHED SERIGRAPHIE SERIGRAFADO	TRANSPARENT TRANSPARENT TRANSPARENTE	SERIGRAPHED SERIGRAPHIE SERIGRAFADO
70 CM	67,5	70	70		
75 CM	72,5	75	75		
80 CM	77,5	80	80		

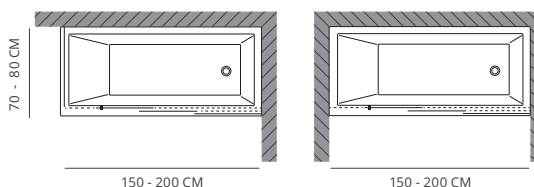



170 CM

BATH ENCLOSURE W/ 2 DOORS + 2 FIXED PANELS
 5 MM TEMPERED GLASS
 SERIGRAPHED GLASS
 CHROMED FRAME
 REVERSIBLE
 HEIGHT 140 CM
 REMOVABLE DOOR FOR EASY CLEANING

PARE-BAIGNOIRE A/ 2 PORTES + 2 PANNEAUX FIXES
 VERRE TREMPÉ 5 MM
 VERRE SERIGRAPHIÉ
 PROFIL CHROMÉ
 REVERSIBLE
 HAUTEUR 140 CM
 PORTE DÉMONTAGE FACILE POUR LE NETTOYAGE

MAMPARA DE BAÑO C/ 2 PUERTAS + 2 PANELES FIJOS VIDRIO
 TEMPLADO 5 MM
 VIDRIO SERIGRAFADO
 PERFIL CROMO
 REVERSIBLE
 ALTURA 140 CM
 PUERTA DESMONTABLE PARA FACILITAR LA LIMPIEZA

FRONT PANEL WITH 2 DOORS + 1 FIXED PANEL
PANNEAU FRONTL AVEC 2 PORTES + 1 PANNEAUX FIXE
PANEL FRONTAL CON 2 PUERTAS + 1 PANEL FIJO

MEASUREMENTS MEDIDAS	ADJUST AJUSTE	TRANSPARENT TRANSPARENTE	SERIGRAPHED SERIGRAFADO
140 CM	136 140 CM		
145 CM	141 145 CM		
150 CM	146 150 CM		
155 CM	151 155 CM		
160 CM	156 160 CM		
165 CM	161 165 CM		
170 CM	166 170 CM		
175 CM	171 175 CM		
180 CM	176 180 CM		

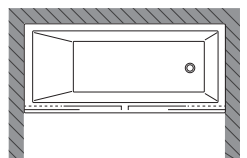

140 - 180 CM

SPECIAL MEASUREMENTS ADDS 25% TO THE PRICE OF THE PREVIOUS MEASURE
DES MESURES SPECIALES AJOUTE 25% SUR LE PRIX DE LA MESURE PRECEDENTE
MEDIDAS ESPECIALES AÑADEN 25% AL PRECIO DE LA MEDIDA ANTERIOR

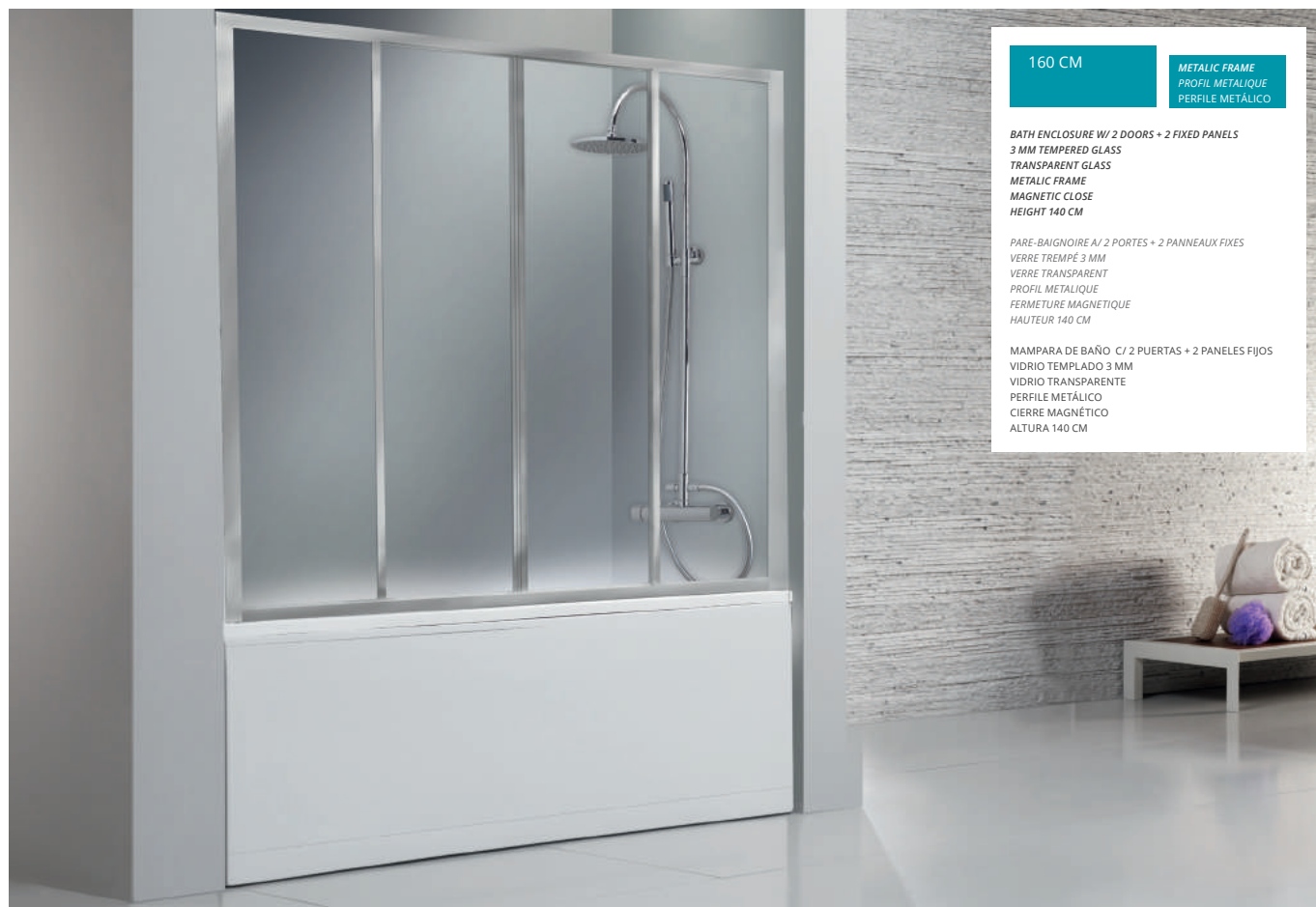

160 CM

METALIC FRAME
PROFIL METALIQUE
PERFILE METÁLICO

BATH ENCLOSURE W/ 2 DOORS + 2 FIXED PANELS
3 MM TEMPERED GLASS
TRANSPARENT GLASS
METALIC FRAME
MAGNETIC CLOSE
HEIGHT 140 CM

PARE-BAIGNOIRE A/ 2 PORTES + 2 PANNEAUX FIXES
VERRE TREMPÉ 3 MM
VERRE TRANSPARENT
PROFIL METALIQUE
FERMETURE MAGNETIQUE
HAUTEUR 140 CM

MAMPARA DE BAÑO C/ 2 PUERTAS + 2 PANELES FIJOS
VIDRIO TEMPLADO 3 MM
VIDRIO TRANSPARENTE
PERFILE METÁLICO
CIERRE MAGNÉTICO
ALTURA 140 CM



160 CM

WHITE FRAME
PROFIL BLANC
PERFILE BLANCO

BATH ENCLOSURE W/ 2 DOORS + 2 FIXED PANELS
3 MM TEMPERED GLASS
SERIGRAPHED GLASS
WHITE FRAME
MAGNETIC CLOSE
HEIGHT 140 CM

PARE-BAIGNOIRE A/ 2 PORTES + 2 PANNEAUX FIXES
VERRE TREMPÉ 3 MM
VERRE SÉRIGRAPHÉ
PROFIL BLANC
FERMETURE MAGNETIQUE
HAUTEUR 140 CM

MAMPARA DE BAÑO C/ 2 PUERTAS + 2 PANELES FIJOS
VIDRIO TEMPLADO 3 MM
VIDRIO SERIGRAFADO
PERFILE BLANCO
CIERRE MAGNÉTICO
ALTURA 140 CM

FRONT PANEL WITH 2 DOORS + 2 FIXED PANELS
PANNEAU FRONTL AVEC 2 PORTES + 2 PANNEAUX FIXES
PANEL FRONTAL CON 2 PUERTAS + 2 PANELES FIJOS

MEASUREMENTS MESURES MEDIDAS	ADJUST AJUSTER AJUSTE	WHITE FRAME PROFIL BLANC PERFILE BLANCO		METALIC FRAME PROFIL METALIQUE PERFILE METÁLICO	
		TRANSPARENT TRANSPARENT TRANSPARENTE	SERIGRAPHE SÉRIGRAPHÉ SERIGRAFADO	TRANSPARENT TRANSPARENT TRANSPARENTE	SERIGRAPHE SÉRIGRAPHÉ SERIGRAFADO
140 CM	137 142 CM				
145 CM	142 147 CM				
150 CM	147 152 CM				
155 CM	152 157 CM				
160 CM	157 162 CM				
165 CM	162 167 CM				
170 CM	167 172 CM				
175 CM	172 177 CM				
180 CM	177 182 CM				
185 CM	182 187 CM				
190 CM	187 192 CM				
195 CM	192 197 CM				
200 CM	197 202 CM				

SIDE PANEL // PANNEAU LATÉRAL // PANEL LATERAL

MEASUREMENTS MESURES MEDIDAS	ADJUST AJUSTER AJUSTE	WHITE FRAME PROFIL BLANC PERFILE BLANCO		METALIC FRAME PROFIL METALIQUE PERFILE METÁLICO	
		TRANSPARENT TRANSPARENT TRANSPARENTE	SERIGRAPHE SÉRIGRAPHÉ SERIGRAFADO	TRANSPARENT TRANSPARENT TRANSPARENTE	SERIGRAPHE SÉRIGRAPHÉ SERIGRAFADO
70 CM	67,5 70 CM				
75 CM	72,5 75 CM				
80 CM	77,5 80 CM				

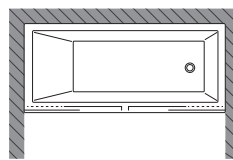

140 - 200 CM



160 CM **METALIC FRAME**
PROFIL METALIQUE
PERFILE METÁLICO

BATH ENCLOSURE W/ 1 DOOR + 1 FIXED PANEL
3 MM TEMPERED GLASS
SERIGRAPHED GLASS
METALIC FRAME
MAGNETIC CLOSE
HEIGHT 140 CM

PARE-BAIGNOIRE A/ 1 PORTE + 1 PANNEAU FIXE
VERRE TREMPÉ 3 MM
VERRE SÉRIGRAPHÉ
PROFIL METALIQUE
FERMETURE MAGNETIQUE
HAUTEUR 140 CM

MAMPARA DE BAÑO C/ 1 PUERTA + 1 PANEL FIJO
VIDRIO TEMPLADO 3 MM
VIDRIO SERIGRAFADO
PERFILE METÁLICO
CIERRE MAGNÉTICO
ALTURA 140 CM

FRONT PANEL WITH 1 DOOR + 1 FIXED PANEL
PANNEAU FRONTL AVEC 1 PORTE + 1 PANNEAU FIXE
PANEL FRONTAL CON 1 PUERTA + 21 PANEL FIJO

MEASUREMENTS MESURES MEDIDAS	ADJUST AJUSTER AJUSTE	WHITE FRAME PROFIL BLANC PERFILE BLANCO		METALIC FRAME PROFIL METALIQUE PERFILE METÁLICO	
		TRANSPARENT TRANSPARENT TRANSPARENTE	SERIGRAPHED SÉRIGRAPHÉ SERIGRAFADO	TRANSPARENT TRANSPARENT TRANSPARENTE	SERIGRAPHED SÉRIGRAPHÉ SERIGRAFADO
140 CM	137 142 CM				
145 CM	142 147 CM				
150 CM	147 152 CM				
155 CM	152 157 CM				
160 CM	157 162 CM				
165 CM	162 167 CM				
170 CM	167 172 CM				
175 CM	172 177 CM				
180 CM	177 182 CM				
185 CM	182 187 CM				
190 CM	187 192 CM				
195 CM	192 197 CM				
200 CM	197 202 CM				

SIDE PANEL // PANNEAU LATÉRAL // PANEL LATERAL

MEASUREMENTS MESURES MEDIDAS	ADJUST AJUSTER AJUSTE	WHITE FRAME PROFIL BLANC PERFILE BLANCO		METALIC FRAME PROFIL METALIQUE PERFILE METÁLICO	
		TRANSPARENT TRANSPARENT TRANSPARENTE	SERIGRAPHED SÉRIGRAPHÉ SERIGRAFADO	TRANSPARENT TRANSPARENT TRANSPARENTE	SERIGRAPHED SÉRIGRAPHÉ SERIGRAFADO
70 CM	67,5 70 CM				
75 CM	72,5 75 CM				
80 CM	77,5 80 CM				

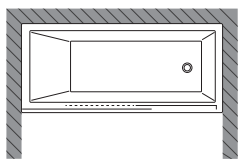

140 - 200 CM



160 CM **WHITE FRAME**
PROFIL BLANC
PERFILE BLANCO

BATH ENCLOSURE W/ 1 DOOR + 1 FIXED PANEL
3 MM TEMPERED GLASS
TRANSPARENT GLASS
WHITE FRAME
MAGNETIC CLOSE
HEIGHT 140 CM

PARE-BAIGNOIRE A/ 1 PORTE + 1 PANNEAU FIXE
VERRE TREMPÉ 3 MM
VERRE TRANSPARENT
PROFIL BLANC
FERMETURE MAGNETIQUE
HAUTEUR 140 CM

MAMPARA DE BAÑO C/ 1 PUERTA + 1 PANEL FIJO
VIDRIO TEMPLADO 3 MM
VIDRIO TRANSPARENTE
PERFILE BLANCO
CIERRE MAGNÉTICO
ALTURA 140 CM



120 CM

1 MOVING PANEL + 1 FIXED PANEL BATH SCREEN
 6 MM TEMPERED GLASS
 SERIGRAPHED GLASS
 CHROMED FRAME
 CHROMED FIXING ROD INCLUDED
 HEIGHT 150 CM

PARE-BAIGNOIRE A/ 1 PANNEAU PIVOTANT + 1 PANNEAU FIXE
 VERRE TREMPÉ 6 MM
 VERRE SÉRIGRAPHIÉ
 PROFIL CHROMÉ
 INCLUS BARRE CHROMÉ DE FIXATION
 HAUTEUR 150 CM

SEPARADOR BAÑERA C/ 1 PUERTA PRACTICABLE + 1 HOJA FIJA
 VIDRIO TEMPLADO 6 MM
 VIDRIO SERIGRAFADO
 PERFIL CROMO
 INCLUIDO VARILLA DE FIJACIÓN CROMO
 ALTURA 150 CM

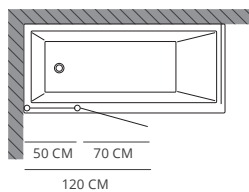

PANEL BATH SCREEN W/ 1 MOVING PANEL + 1 FIXED PANEL
 PARE-BAIGNOIRE A/ 1 PANNEAU PIVOTANT + 1 PANNEAU FIXE
 SEPARADOR BAÑERA C/ 1 PUERTA PRACTICABLE + 1 HOJA FIJA

MEASUREMENTS MESURES MEDIDAS	TRANSPARENT TRANSPARENT TRANSPARENTE	SERIGRAPHED SÉRIGRAPHÉ SERIGRAFADO
120 CM		



90 CM

FIXED PANEL BATH SCREEN
6 MM TEMPERED GLASS
TRANSPARENT GLASS
CHROMED FRAME
CHROMED FIXING ROD INCLUDED
HEIGHT 150 CM

PARE-BAIGNOIRE A/ 1 PANNEAU FIXE
VERRE TREMPÉ 6 MM
VERRE TRANSPARENT
PROFIL CHROMÉ
INCLUS BARRE CHROMÉ DE FIXATION
HAUTEUR 150 CM

SEPARADOR BAÑERA C/ 1 HOJA FIJA
VIDRIO TEMPLADO 6 MM
VIDRIO TRANSPARENTE
PERFILE CROMO
INCLUIDO VARILLA DE FIJACIÓN CROMO
ALTURA 150 CM

PANEL BATH SCREEN W/ 1 FIXED PANEL
PARE-BAIGNOIRE A/ 1 PANNEAU FIXE
SEPARADOR BAÑERA C/ 1 PANEL FIJO

MEASUREMENTS MESURES MEDIDAS	TRANSPARENT TRANSPARENT TRANSPARENTE	SERIGRAPHED SERIGRAPHIE SERIGRAFADO
70 CM		
80 CM		
90 CM		

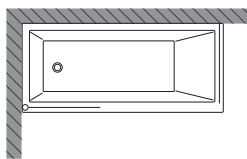

70 - 90 CM

PANEL BATH SCREEN W/ 1 MOVING PANEL + 1 FIXED PANEL
PARE-BAIGNOIRE A/ 1 PANNEAU PIVOTANT + 1 PANNEAU FIXE
SEPARADOR BAÑERA C/ 1 PUERTA PRACTICABLE + 1 HOJA FIJA

MEASUREMENTS MESURES MEDIDAS	TRANSPARENT TRANSPARENT TRANSPARENTE	SERIGRAPHED SERIGRAPHIE SERIGRAFADO
120 CM		

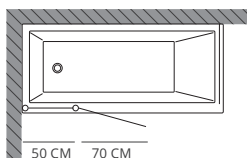

50 CM 70 CM
120 CM



120 CM

1 MOVING PANEL + 1 FIXED PANEL BATH SCREEN
6 MM TEMPERED GLASS
TRANSPARENT GLASS
CHROMED FRAME
CHROMED FIXING ROD INCLUDED
HEIGHT 150 CM

PARE-BAIGNOIRE A/ 1 PANNEAU PIVOTANT + 1 PANNEAU FIXE
VERRE TREMPÉ 6 MM
VERRE TRANSPARENT
PROFIL CHROMÉ
INCLUS BARRE CHROMÉ DE FIXATION
HAUTEUR 150 CM

SEPARADOR BAÑERA C/ 1 PUERTA PRACTICABLE + 1 HOJA FIJA
VIDRIO TEMPLADO 6 MM
VIDRIO TRANSPARENTE
PERFILE CROMO
INCLUIDO VARILLA DE FIJACIÓN CROMO
ALTURA 150 CM



120 CM

1 MOVING PANEL + 1 FIXED PANEL BATH SCREEN
6 MM TEMPERED GLASS
TRANSPARENT GLASS
CHROMED FRAME
OPENING TO THE OUTSIDE
HEIGHT 140 CM

PARE-BAIGNOIRE A/ 1 PANNEAU PIVOTANT + 1 PANNEAU FIXE
VERRE TREMPÉ 6 MM
VERRE TRANSPARENT
PROFIL CHROMÉ
OUVERTURE À L'EXTÉRIEUR
HAUTEUR 140 CM

SEPARADOR BAÑERA C/ 1 PUERTA PRACTICABLE + 1 HOJA FIJA
VIDRIO TEMPLADO 6 MM
VIDRIO TRANSPARENTE
PERFILE CROMO
APERTURA AL EXTERIOR
ALTURA 140 CM



PRACTICE AND COMFORT

EOLO is presented with a double bath panel, which stands out for chromed profile fixed to the wall and the metal shaft that unites the two parties providing additional strength for practical use in your daily shower.

PRATIQUE ET CONFORT

EOLO se présente avec un double panneau de bain, qui est en évidence par le profil de chrome fixé au mur et la tige métallique qui relie les deux parties en donnant résistance supplémentaire à une utilisation pratique dans votre douche quotidienne.

FUNCIONAL Y CONFORTABLE

EOLO se presenta con un panel de baño doble, que se destaca por el perfil de cromo fijado a la pared y la barra de metal que une las dos partes que aportan una resistencia adicional para su uso práctico en la ducha en el día a día.

PANEL BATH SCREEN W/ 1 MOVING PANEL + 1 FIXED PANEL
PARE-BAIGNOIRE A/ 1 PANNEAU PIVOTANT + 1 PANNEAU FIXE
SEPARADOR BAÑERA C/ 1 PUERTA PRACTICABLE + 1 HOJA FIJA

MEASUREMENTS / MESURES / MEDIDAS TRANSPARENT / TRANSPARENT / TRANSPARENTE SERIGRAPHED / SERIGRAPHIE / SERIGRAFADO

120 CM

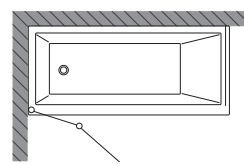

120 CM



80 CM

1 MOVING PANEL BATH SCREEN
6 MM TEMPERED GLASS
TRANSPARENT GLASS
CHROMED FRAME
HEIGHT 140 CM

PARE-BAIGNOIRE A/ 1 PANNEAU PIVOTANT
VERRE TREMPÉ 6 MM
VERRE TRANSPARENT
PROFIL CHROMÉ
HAUTEUR 140 CM

SEPARADOR BAÑERA C/ 1 PUERTA PRACTICABLE
VIDRIO TEMPLADO 6 MM
VIDRIO TRANSPARENTE
PERFILE CROMO
ALTURA 140 CM

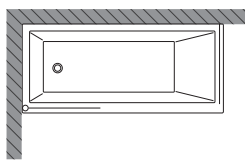

80 CM

PANEL BATH SCREEN W/ 1 MOVING PANEL
PARE-BAIGNOIRE A/ 1 PANNEAU PIVOTANT
SEPARADOR BAÑERA C/ 1 PUERTA PRACTICABLE

MEASUREMENTS MESURES MEDIDAS	TRANSPARENT TRANSPARENT TRANSPARENTE	SERIGRAPHED SERIGRAPHIE SERIGRAFADO
80 CM		

80 CM



FREE ACCESS TO SHOWER SHOWER DRAINS LIBRE ACCÈS À LA DOUCHE CANIVEAUX DE DOUCHE LIBRE ACCESO A LA DUCHA CANALETAS DE DUCHA



- Shower drains with PVC body
- Grill in stainless steel AISI 304
- Available in lengths of: 400, 600 and 800 mm
- Includes levers for better adaptability
- With isolation membrane for better sealing
- For use in shower areas

- Caniveaux de douche avec corp PVC
- Grill en acier inoxydable AISI 304
- Disponible en longueurs de: 400, 600 and 800 mm
- Comprend des niveleus, pour une meilleur adaptabilité
- Inclut membrane pour une meilleur imperméabilisation
- Pour une utilisation das les zones de douche

- Canaleta de ducha con cuerpo de PVC
- Rejilla y marco en acero inoxidable AISI 304
- Disponible en largos de: 400, 600 y 800 mm
- Incluye nivelación para una mejor adaptabilidad
- Se suministra con pantalla de aislamiento
- Para uso en zonas de ducha

WAY

SHOWER DRAINS // CANIVEAUX DE DOUCHE // CANALETAS DE DUCHA

400 x 70 MM
600 x 70 MM
800 x 70 MM

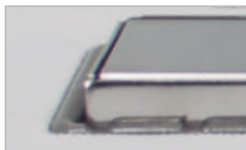

FLOOR SIPHON // SIPHON PLANCHER // SIFÓN PISO AISI 304

- Floor Siphon with PVC body
- Grill in stainless steel AISI 304
- With isolation membrane for better sealing
- For use in shower areas



- Caniveaux de douche avec corp PVC
- Grill en acier inoxydable AISI 304
- Inclut membrane pour une meilleur imperméabilisation
- Pour une utilisation das les zones de douche

- Sifón de suelo com estrutura de PVC
- Rejilla de acero inoxidable AISI 304
- Con retención de olores
- Para uso en zonas de ducha

SQUARE

FLOOR SIPHON // SIPHON PLANCHER // SIFÓN PISO

200 x 200 - Ø50 MM

- Floor Siphon with PVC body
- Grill in stainless steel AISI 304
- With isolation membrane for better sealing
- For use in shower areas



- Caniveaux de douche avec corp PVC
- Grill en acier inoxydable AISI 304
- Inclut membrane pour une meilleur imperméabilisation
- Pour une utilisation das les zones de douche

- Sifón de suelo com estrutura de PVC
- Rejilla de acero inoxidable AISI 304
- Con retención de olores
- Para uso en zonas de ducha

LINE

FLOOR SIPHON // SIPHON PLANCHER // SIFÓN PISO

200 x 200 - Ø50 MM

- Floor Siphon with PVC body
- Grill in stainless steel AISI 304
- With isolation membrane for better sealing
- For use in shower areas



- Caniveaux de douche avec corp PVC
- Grill en acier inoxydable AISI 304
- Inclut membrane pour une meilleur imperméabilisation
- Pour une utilisation das les zones de douche

- Sifón de suelo com estrutura de PVC
- Rejilla de acero inoxidable AISI 304
- Con retención de olores
- Para uso en zonas de ducha

SQUARE

FLOOR SIPHON // SIPHON PLANCHER // SIFÓN PISO

200 x 200 - Ø50 MM

- Floor Siphon with PVC body
- Grill in stainless steel AISI 304
- With isolation membrane for better sealing
- For use in shower areas

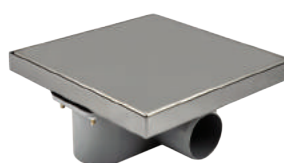

- Caniveaux de douche avec corp PVC
- Grill en acier inoxydable AISI 304
- Inclut membrane pour une meilleur imperméabilisation
- Pour une utilisation das les zones de douche

- Sifón de suelo com estrutura de PVC
- Rejilla de acero inoxidable AISI 304
- Con retención de olores
- Para uso en zonas de ducha

LINE

FLOOR SIPHON // SIPHON PLANCHER // SIFÓN PISO

200 x 200 - Ø50 MM

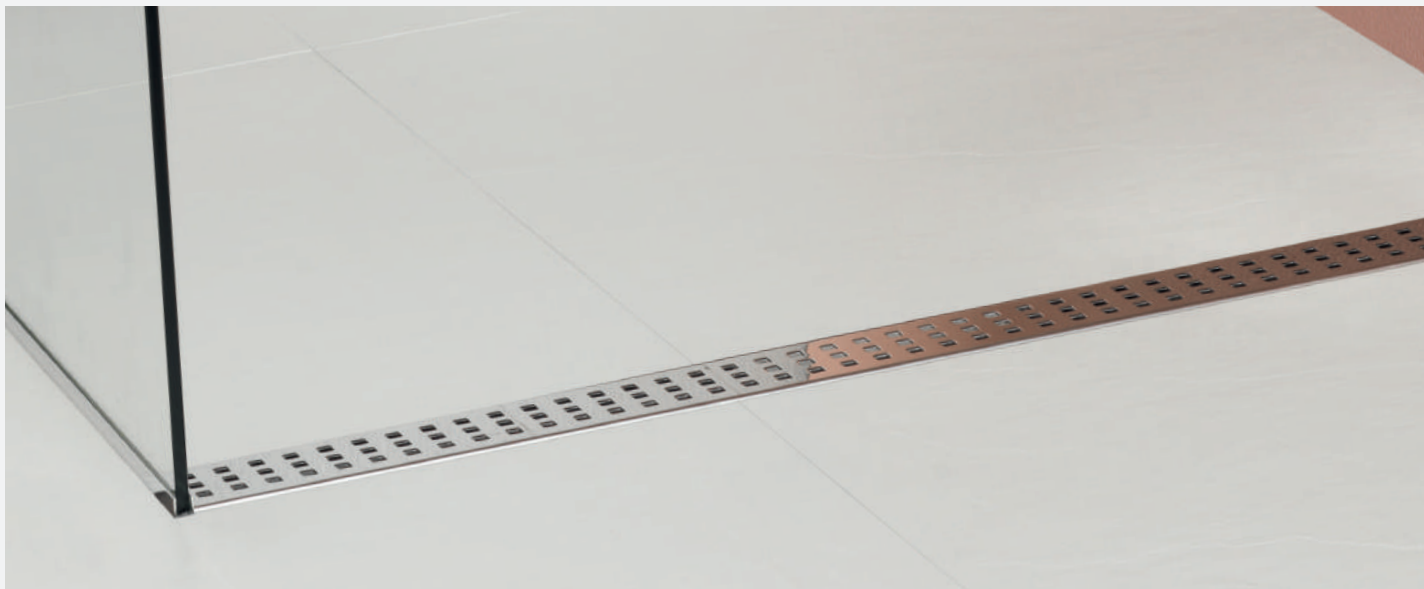

SHOWER DRAIN

STAINLESS STEEL AISI 304

With shower drains Bellian®, we give you the opportunity to build elegant bathroom space, spacious with free access to the shower, in a perfect symbiosis between the minimalist aesthetic and effective drainage. Manufactured in stainless steel (AISI 304) Bellian® drains are available in many models that guarantee a quick and efficient drainage, giving your bathroom space unique beauty hiding the trap and allowing you to pave the shower space with a material of your choice.

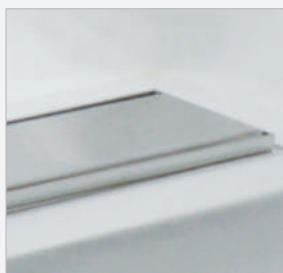

- Shower drains with stainless steel AISI 304 body and grill
- With isolation membrane for better sealing
- Includes levers for better adaptability
- For use in shower areas
- Available in lengths of: 700, 800, 900, 1000 and 1200 mm

- Caniveaux de douche avec corp et grill en acier inoxydable AISI 304
- Comprend des niveleus, pour une meilleur adaptabilité
- Inclut membrane pour une meilleur imperméabilisation
- Pour une utilisation dans les zones de douche
- Disponible en longueurs de : 700, 800, 900, 1000 and 1200 mm

- Canaletas de ducha con cuerpo y rejilla de acero inoxidable AISI 304
- Incluye nivelación para una mejor adaptabilidad
- Con la membrana de aislamiento para un mejor sellado
- Para uso en zonas de ducha
- Disponible en largos de 700, 800, 900, 1000 and 1200 mm

LINE // SQUARE

CALHA DE DUCHE

700 x 70 MM
800 x 70 MM
900 x 70 MM
1000 x 70 MM
1200 x 70 MM

CANIVEAUX DOUCHE

ACIER INOXYDABLE AISI 304

Avec les caniveaux de douche Bellian®, nous vous donnent la possibilité de construire espaces de bain élégantes, spacieuses avec libre accès à la douche, dans une parfaite symbiose entre l'esthétique minimaliste et la drainage efficace. Fabriqués en acier inoxydable (AISI 304) les caniveaux Bellian® sont disponibles en plusieurs modèles que garantissent un drainage rapide et efficace, en donnant à votre espace de bains une beauté unique en cachant le siphon et permettant que vous pavée l'espace de douche avec les matériaux de votre choice.

CANALETAS DUCHA

ACERO INOXYDABLE AISI 304

Con las canaletas de ducha Bellian® le damos la posibilidad de construir un amplio y libre acceso a la ducha, una simbiosis perfecta entre el drenaje eficiente y la estética minimalista. Las canaletas de ducha Bellian® garantizan un drenaje rápido y efectivo, mientras que dan a su espacio de baño una belleza única, que oculta el sifón y permite que el espacio de la ducha sea pavimentado con el material de su elección.



SQUARE



LINE

SHOWER TRAYS

RECEVEURS DE DOUCHE

PLATOS DE DUCHA



SOFT
HEIGHT / HAUTEUR / ALTURA **35 mm**

- Extra flat
- Acrylic shower tray
- Height 35 mm

- Extra plat
- Receveur de douche acrylique
- Hauteur 35 mm

- Extraplano
- Plato de ducha acrílico
- Altura 35 mm



INFINITY
HEIGHT / HAUTEUR / ALTURA **75 mm**

- Acrylic shower tray
- Height 75 mm

- Receveur de douche acrylique
- Hauteur 75 mm

- Plato de ducha acrílico
- Altura 75 mm

SOFT **35 mm** INFINITY **75 mm**

MEASUREMENTS MESURES // MEDIDAS	SOFT 35 mm	INFINITY 75 mm
70 x 90 CM		
70 x 100 CM		
70 x 110 CM		
70 x 120 CM		
70 x 130 CM		
70 x 140 CM		
70 x 150 CM		
70 x 160 CM		
70 x 170 CM		
70 x 180 CM		
70 x 190 CM		
70 x 200 CM		
75 x 90 CM		
75 x 100 CM		
75 x 110 CM		
75 x 120 CM		
75 x 130 CM		
75 x 140 CM		
75 x 150 CM		
75 x 160 CM		
75 x 170 CM		
75 x 180 CM		
75 x 190 CM		
75 x 200 CM		
80 x 90 CM		
80 x 100 CM		
80 x 110 CM		
80 x 120 CM		
80 x 130 CM		
80 x 140 CM		
80 x 150 CM		
80 x 160 CM		
80 x 170 CM		
80 x 180 CM		
80 x 190 CM		
80 x 200 CM		
90 x 100 CM		
90 x 110 CM		
90 x 120 CM		
90 x 130 CM		
90 x 140 CM		
90 x 150 CM		
90 x 160 CM		
90 x 170 CM		
90 x 180 CM		
90 x 190 CM		
90 x 200 CM		



SOFT 120
VALVE // VIDAGE // VÁLVULA
Ø120 MM

SUITABLE FOR EXTRA FLAT TRAYS | HOLE Ø90 MM
ADAPTÉ AUX BASES ULTRA-PLATS | TROU Ø90 MM
INDICADA PARA BASES EXTRAPLANAS | AGUJERO Ø90 MM



DROP

MEASUREMENTS // MESURES // MEDIDAS

70 x 100 CM
70 x 110 CM
70 x 120 CM
70 x 130 CM
70 x 140 CM
70 x 150 CM
70 x 160 CM
70 x 170 CM
70 x 180 CM
80 x 100 CM
80 x 110 CM
80 x 120 CM
80 x 130 CM
80 x 140 CM
80 x 150 CM
80 x 160 CM
80 x 170 CM
80 x 180 CM
90 x 100 CM
90 x 110 CM
90 x 120 CM
90 x 130 CM
90 x 140 CM
90 x 150 CM
90 x 160 CM
90 x 170 CM
90 x 180 CM



SOFT 120

VALVE // VIDAGE // VÁLVULA

Ø120 MM

SUITABLE FOR EXTRA FLAT TRAYS | HOLE Ø90 MM
 ADAPTE AUX BASES ULTRA-PLATS | TROU Ø90 MM
 INDICADA PARA BASES EXTRAPLANAS | AGUJERO Ø90 MM

PLATE



SHOWER TRAY ACRYLIC W/ REMOVABLE COVER

PLATE is an acrylic shower tray model, reinforced with glass fiber and with removable cover, for easy cleaning on the water flow. The removable cover is available in stainless steel or acrylic.

RECEVEUR DE DOUCHE ACRYLIQUE A/ COUVERCLE AMOVIBLE

PLATE est un modèle de receveur de douche en acrylique, renforcé par fibre de verre et avec couvercle amovible, pour faciliter le nettoyage dans l'écoulement de l'eau. Le couvercle amovible est disponible en acier inoxydable ou en acrylique.

PLATO DE DUCHA ACRÍLICO C/ TAPA DESMONTABLE

PLATE es un modelo de plato de ducha acrílico, reforzado con fibra de vidrio y con tapa extraíble, para facilitar la limpieza del sifón para amehorar el flujo de agua. La tapa extraíble está disponible en acero inoxidable o acrílico.



HEIGHT
HAUTEUR
ALTURA **75mm**

- Acrylic shower tray
- Amovible
- Hidden outflow
- Height 75 mm

- Receveur de douche acrylique
- Removable
- Écoulement caché
- Hauteur 75mm

- Plato de ducha acrílico
- Extraíble
- Salida de flujos ocultos
- Altura 75 mm



HEIGHT
HAUTEUR
ALTURA **75mm**

- Acrylic shower tray
- Cover stainless steel removable
- Hidden outflow
- Height 75 mm

- Receveur de douche acrylique
- Couverture acier inoxydable 304
- Écoulement caché
- Hauteur 75mm

- Plato de ducha acrílico
- Cover extraíble de acero inoxidable
- Salida de flujos ocultos
- Altura 75 mm



PLATE

MEASUREMENTS
MESURES // MEDIDAS

	ACRYLIC COVER COUVERCLE ACRYLIQUE TAPA DE ACRILICO	STAINLESS STEEL COVER COUVERCLE ACIER INOX. TAPA DE ACERO INOX.
80 x 100 CM		
80 x 110 CM		
80 x 120 CM		
80 x 130 CM		
80 x 140 CM		

- Extra flat
- Square acrylic shower tray
- Height 35 mm

- Extra plat
- Carré Receveur de douche acrylique
- Hauteur 35 mm

- Extraplano
- Plato de ducha acrílico cuadrada
- Altura 35 mm

SOFT

MEASUREMENTS // MESURES // MEDIDAS

70 x 70 CM
75 x 75 CM
80 x 80 CM
90 x 90 CM

SOFT
HEIGHT
HEIGHT
ALTURA **35mm**



- Square acrylic shower tray
- Height 35 mm

- Carré Receveur de douche acrylique
- Hauteur 35 mm

- Plato de ducha acrílico cuadrada
- Altura 35 mm

INFINITY

MEASUREMENTS // MESURES // MEDIDAS

70 x 70 CM
75 x 75 CM
80 x 80 CM
90 x 90 CM

INFINITY
HEIGHT
HEIGHT
ALTURA **75mm**



- Extra flat
- Round acrylic shower tray
- r550 mm

- Extra plat
- Receveur de douche rond acrylique
- r550 mm

- Extraplano
- Plato de ducha acrílico circular
- r550 mm

PLANUS

MEASUREMENTS // MESURES // MEDIDAS

80 x 80 CM
90 x 90 CM

PLANUS
HEIGHT
HEIGHT
ALTURA **35mm**



- Round acrylic shower tray
- r550 mm

- Receveur de douche rond acrylique
- r550 mm

- Plato de ducha acrílico circular
- r550 mm

TIME

MEASUREMENTS // MESURES // MEDIDAS

80 x 80 CM
90 x 90 CM

TIME
HEIGHT
HEIGHT
ALTURA **75mm**



VALVES
VIDAGES
VALVULASSOFT 120
VALVE // VIDAGE // VÁLVULA

Ø120 MM

SUITABLE FOR ULTRA-FLAT BASES | HOLE Ø90 MM
ADAPTE AUX BASES ULTRA-PLATS | TROU Ø90 MM
INDICADA PARA BASES EXTRAPLANAS | AGUJERO Ø90 MMLUX 115
VALVE // VIDAGE // VÁLVULA

Ø115 MM

HOLE Ø90 MM
TROU Ø90 MM
AGUJERO Ø90 MMPOP VERTICAL
VALVE // VIDAGE // VÁLVULA

Ø115 MM

HOLE Ø90 MM
TROU Ø90 MM
AGUJERO Ø90 MMLUX 90
VALVE // VIDAGE // VÁLVULA

Ø90 MM

HOLE Ø60 MM
TROU Ø60 MM
AGUJERO Ø60 MM

FOR A QUICK AND EFFECTIVE DRAINAGE

The BMK® shower valves are designed to allow quick and easy installation and easy access for maintenance, ensuring a perfect drainage in any installation.

The universality is reflected in the range of BMK® shower valves where you will find the solution to any measure of hole drilling of your shower base. The impurities retention system avoids the entrainment of dirt into the drainage system, while contributing to non return of odors. The grids in chromed ABS and modern design are the perfect finish to beautify your shower tray.

POUR UN DRAINAGE RAPIDE ET EFFICACE

Les valves de douche BMK® sont conçus pour permettre une installation rapide et facile et un accès faciles pour le maintenance, en assurant un drainage parfait dans toute installation.

L'universalité se reflète dans la gamme de valves de douche BMK® où vous trouverez la solution à toute mesure du trou de votre bac de douche. Le système de retenue des impuretés évite l'entraînement de la saleté dans le réseau de drainage, tout en contribuant pou le non-reflux des odeurs. Les grilles en ABS chromé et un design moderne sont la finition parfaite pour embellir votre bac de douche.

PARA EL DRENAJE RÁPIDO Y EFICAZ

Las válvulas de ducha BMK® están diseñadas para permitir una instalación fácil y rápida y un fácil acceso para mantenimiento, asegurando un perfecto drenaje en cualquier instalación.

La universalidad se refleja en la gama de válvulas de ducha BMK® donde se encuentra la solución a cualquier medida del agujero de su plato de ducha. El sistema de retención de impurezas evita el arrastre de suciedad en la red de drenaje, al tiempo que contribuye como antiretorno de olores. Las rejillas en ABS cromado de diseño moderno son el acabado perfecto para embellecer su plató de ducha.



BATH & HYDROMASSAGE SYSTEMS

BAIN & SYSTÈMES D'HYDROMASSAGE

BAÑO & SISTEMAS DE HIDROMASAJE

HYDROMASSAGE SYSTEMS // SYSTÈMES D'HYDROMASSAGE // SISTEMA DE HIDROMASAJE

	TECHNO DUE	TECHNO	EASY
BOMB BOMBE BOMBA	800 W	800 W	500 W
REGULATOR AIR SIMPLE SIMPLE REGULATEUR AIR REGULADOR DE AIRE SIMPLES	-	✓	✓
SYSTEM WITH OUTDOOR SETTING SYSTÈME AVEC RAGLAGE EXTÉRIEUR SISTEMA DE AJUSTE DE AIRE LIBRE	✓	✓	-
SUPPORTS ANTI-SHAKE SUPPORTS ANTI-SHAKE SOPORTES ANTI VIBRACIÓN	✓	-	✓
ILLUMINATED TOUCH BUTTON BOUTON TACTILE LUMINEUX SOPORTES ANTI VIBRACIÓN	2 FUNCTIONS 2 FONCTIONS 2 FUNCIONES	1 FUNCTION 1 FONCTION 1 FUNCIÓN	-
SMALL JETS STEERABLE PETITS JETS ORIENTABLES BOTÓN TÁCTIL ILLUMINADO	-	-	32 x 20 MM
BIG PREMIUM JETS JETS BIG PREMIUM JETS PEQUEÑOS ORIENTABLES	✓	✓	-
ANTI LIMESTONE, STEERABLE AND ADJUSTABLE JETS JETS ANTI CALCAIRE, ORIENTABLES ET RÉGLABLES JETS ANTI CALIZA ORIENTABLES Y AJUSTABLES	✓	✓	-
AIR LOWER PREMIUM JETS JETS AIR INFÉRIEUR PREMIUM JETS DE AIRE INFERIORES PREMIUM	✓	-	-
SAFETY VALVE SAFETY VALVE VÁLVULA DE SEGURIDAD	✓	✓	✓
ASPIRATION ASPIRATEUR ASPIRACIÓN	PREMIUM	PREMIUM	STANDARD
AUTOMATIC AND SILENT BLOWER VENTILATEUR AUTOMATIQUE ET SILENCIEUX VENTILADOR AUTOMÁTICO Y SILENCIOSO	✓	-	-
CHROMOTHERAPY (KIT 12 LEDS) CHROMOTHÉRAPIE (KIT 12 LEDS) CROMOTERAPIA (KIT DE 12 LEDS)	OPTIONAL OPTIONAL // OPCIONAL	-	-
ELECTRONIC SENSOR LEVEL SONDE NIVEAU ÉLECTRONIQUE SONDA DE NÍVEL ELECTRÓNICO	✓	✓	-
AIR SENSOR LEVEL SONDE NIVEAU AIR SONDA DE NÍVEL DE AIRE	-	-	OPTIONAL OPTIONAL // OPCIONAL



CHROMOTHERAPY

IMPROVES YOUR PHYSICAL, PSYCHOLOGICAL AND EMOTIONAL HEALTH

Chromotherapy available in Techno Due model as an option, offers you a full bath of well-being and comfort provided by the combination of the revitalizing properties of light with the relaxing properties of an immersion bath.

CHROMOTHÉRAPIE

AMÉLIORE VOTRE SANTÉ PHYSIQUE, PSYCHOLOGIQUE ET ÉMOTIONNEL

La Chromothérapie disponible dans le modèle Techno Due comme une option, vous propose une gamme complète de bien-être et confort fournit par la combinaison des propriétés revitalisantes de la lumière avec les propriétés relaxantes d'un bain.

CROMOTERAPIA

MEJORA SU SALUD FÍSICA, PSICOLÓGICA Y EMOCIONAL

La cromoterapia disponible en el modelo Techno Due como una opción, le ofrece un baño pleno de bienestar y confort proporcionado por la combinación de las propiedades revitalizantes de la luz con las propiedades relajantes de un baño de inmersión.

BATHTUB W/ HYDROMASSAGE SYSTEM

BAIGNOIREC A/ SYSTÈME D'HYDROMASSAGE

BAÑERA CON SISTEMA DE HIDROMASAJE

MEASUREMENTS MESURES // MEDIDAS	SYSTEMS SYSTÈMES // SISTEMAS
130 x 130 CM	TECHNO DUE
	TECHNO
	EASY

BATHTUB // BAIGNOIRE // BAÑERA

MEASUREMENTS MESURES // MEDIDAS
130 x 130 CM



130 X 130 CM

Corner Acrylic Bathtub
Anti skid
Lumbar support
Complementary with panels corner (pag 242)
EASy hydromassage system
Pneumatic system
6 small rotating jets
Reinforced chassis

Baignoire acrylique d'angle
Antiderapage
Appuie-lombaire
Complémentaire avec panneaux d'angle (pag 242)
Système d'hydromassage EASY
Système pneumatique
6 jets petit orientables
Châssis renforcé

Bañera de esquina acrílica
Antiderrape
Soporte lumbar
Complementaria con paneles de esquina (pag 242)
Sistema de Hidromasaje EASY
Sistema de neumáticos
6 jets pequeños orientables
Chasis reforzado

SOFIA

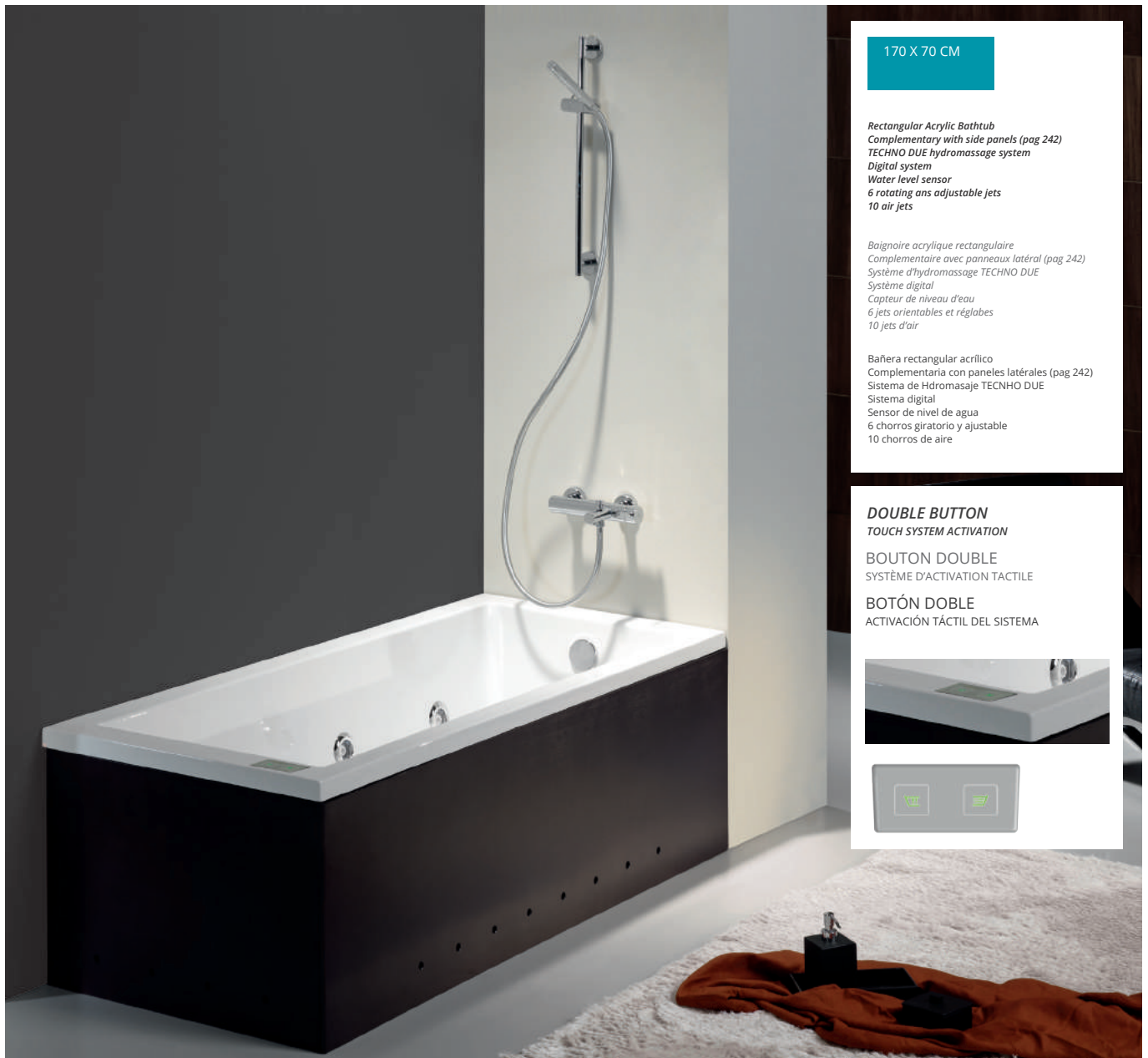

170 X 70 CM

Rectangular Acrylic Bathtub
 Complementary with side panels (pag 242)
TECHNO DUE hydromassage system
 Digital system
 Water level sensor
 6 rotating ans adjustable jets
 10 air jets

Baignoire acrylique rectangulaire
 Complémentaire avec panneaux latéral (pag 242)
 Système d'hydromassage TECHNO DUE
 Système digital
 Capteur de niveau d'eau
 6 jets orientables et réglables
 10 jets d'air

Bañera rectangular acrílico
 Complementaria con paneles laterales (pag 242)
 Sistema de Hdromasaje TECHNO DUE
 Sistema digital
 Sensor de nivel de agua
 6 chorros giratorio y ajustable
 10 chorros de aire

DOUBLE BUTTON
 TOUCH SYSTEM ACTIVATION
 BOUTON DOUBLE
 SYSTÈME D'ACTIVATION TACTILE
 BOTÓN DOBLE
 ACTIVACIÓN TÁCTIL DEL SISTEMA



BATHUB // Baignoire // Bañera

MEASUREMENTS MESURES // MEDIDAS
160 x 70 CM
170 x 70 CM
170 x 75 CM
180 x 80 CM

BATHTUB W/ HYDROMASSAGE SYSTEM
 BAIGNOIREC A/ SYSTÈME D'HYDROMASSAGE
 BAÑERA CON SISTEMA DE HIDROMASAJE

MEASUREMENTS MESURES // MEDIDAS	SYSTEMS SYSTÈMES // SISTEMAS
180 x 80 CM	TECHNO DUE
	TECHNO
	EASY
170 x 75 CM	TECHNO DUE
	TECHNO
	EASY
170 x 70 CM	TECHNO DUE
	TECHNO
	EASY
160 x 70 CM	TECHNO DUE
	TECHNO
	EASY



170 X 70 CM

Rectangular Acrylic Bathtub
 Anti skid
 Lumbar support
 Arms support
 Complementary with panels (pag 242)
 EASY hydromassage system
 Pneumatic system
 6 rotating ans adjustable jets
 Simple Chassis

Baignoire acrylique rectangulaire
 Antiderapage
 Appui-lombaire
 Appui-bras
 Complémentaire avec panneaux (pag 242)
 Système d'hydromassage EASY
 Système pneumatique
 6 jets orientables et réglables
 Chassis simple

Bañera rectangular acrílico
 Antiderrape
 Soporte lumbar
 Soporte de brazos
 Complementaria con paneles laterales (pag 242)
 Sistema de hidromasaje EASY
 Sistema de neumáticos
 6 chorros giratorio y ajustable
 Chassis simples

BATHTUB W/ HYDROMASSAGE SYSTEM
 BAIGNOIREC A/ SYSTÈME D'HYDROMASSAGE
 BAÑERA CON SISTEMA DE HIDROMASAJE

MEASUREMENTS MESURES // MEDIDAS	SYSTEMS SYSTÈMES // SISTEMAS
170 x 80 CM	TECHNO DUE
	TECHNO
	EASY
170 x 75 CM	TECHNO DUE
	TECHNO
	EASY
170 x 70 CM	TECHNO DUE
	TECHNO
	EASY

BATHTUB W/ HYDROMASSAGE SYSTEM
 BAIGNOIREC A/ SYSTÈME D'HYDROMASSAGE
 BAÑERA CON SISTEMA DE HIDROMASAJE

MEASUREMENTS MESURES // MEDIDAS	SYSTEMS SYSTÈMES // SISTEMAS
160 x 75 CM	TECHNO DUE
	TECHNO
	EASY
160 x 70 CM	TECHNO DUE
	TECHNO
	EASY
150 x 70 CM	TECHNO DUE
	TECHNO
	EASY



BATHUB // BAIGNOIRE // BAÑERA

MEASUREMENTS MESURES // MEDIDAS
140 x 70 CM
150 x 70 CM
160 x 70 CM
160 x 75 CM
170 x 70 CM
170 x 75 CM
170 x 80 CM

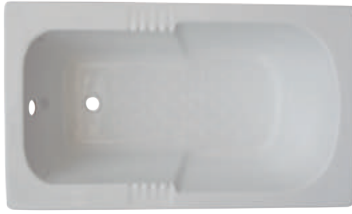

Rectangular acrylic bathtub
Anti skid
Lumbar support
Complementary with panels

Baignoire acrylique rectangulaire
Antiderapage
Appui-lombaire
Complémentaire avec panneaux

Bañera rectangular acrílico
Antiderrape
Soporte lumbar
Complementaria con paneles laterales

BATHUB // BAIGNOIRE // BAÑERA

MEASUREMENTS
MESURES // MEDIDAS
120 x 70 CM

BATHTUB PANELS PANNELS DE BAIGNOIRE PANELES BAÑERA



FRONTAL BATHTUB PANELS PANNEAUX FRONTALS DE BAIGNOIRE PANELES FRONTALES DE BAÑERA

MEASUREMENTS MESURES // MEDIDAS	COLOUR COULEUR // COLOR
120 CM	WHITE // BLANC // BLANCO WENGE // WENGÉ // WENGÉ WENGE // WENGÉ // WENGÉ
140 CM	WENGE // WENGÉ // WENGÉ CHERRY // CERISE // CEREZA BROWN // MARRON // MARRÓN
150 CM	WHITE // BLANC // BLANCO WENGE // WENGÉ // WENGÉ CHERRY // CERISE // CEREZA BROWN // MARRON // MARRÓN
160 CM	WHITE // BLANC // BLANCO WENGE // WENGÉ // WENGÉ CHERRY // CERISE // CEREZA BROWN // MARRON // MARRÓN
170 CM	WHITE // BLANC // BLANCO WENGE // WENGÉ // WENGÉ CHERRY // CERISE // CEREZA BROWN // MARRON // MARRÓN
180 CM	WHITE // BLANC // BLANCO WENGE // WENGÉ // WENGÉ CHERRY // CERISE // CEREZA BROWN // MARRON // MARRÓN

SIDE BATHTUB PANELS PANNEAUX LATERALS DE BAIGNOIRE PANELES LATERALES DE BAÑERA

MEASUREMENTS MESURES // MEDIDAS	COLOUR COULEUR // COLOR
70 CM	WHITE // BLANC // BLANCO WENGE // WENGÉ // WENGÉ CHERRY // CERISE // CEREZA BROWN // MARRON // MARRÓN
75 CM	WHITE // BLANC // BLANCO WENGE // WENGÉ // WENGÉ CHERRY // CERISE // CEREZA BROWN // MARRON // MARRÓN
80 CM	WHITE // BLANC // BLANCO WENGE // WENGÉ // WENGÉ CHERRY // CERISE // CEREZA BROWN // MARRON // MARRÓN

BATHTUB CORNER PANEL PANNEAU D'ANGLE BAIGNOIRE PANELES LATERALES DE BAÑERA

MEASUREMENTS MESURES // MEDIDAS	COLOUR COULEUR // COLOR
130 CM	WHITE // BLANC // BLANCO

AVAILABLE FINISHES MARITIME PLYWOOD
OPTIONS CONTREPLAQUÉ MARITIME
ACABADOS DISPONIBLES CONTRACHAPADO MARÍTIMA

AVAILABLE FINISHES ACRYLIC
OPTIONS ACRYLIQUE
ACABADOS DISPONIBLES ACRÍLICO

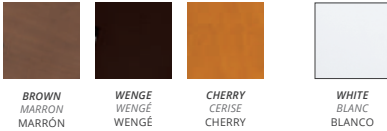

BATHTUB CHASSIS CHÂSSIS DE BAIGNOIRE CHASIS DE BAÑERA

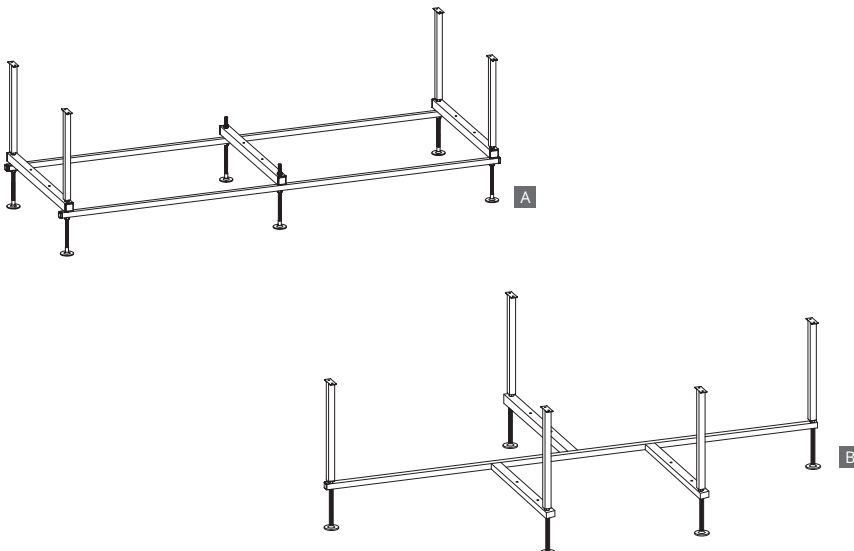

A RECTANGULAR CHASSIS CHÂSSIS RECTANGULAIRE CHASIS RECTANGULAR

MEASUREMENTS MESURES // MEDIDA
120 x 70 CM
140 x 70 CM
150 x 70 CM
160 x 70 CM
160 x 75 CM
170 x 70 CM
170 x 75 CM
170 x 80 CM
180 x 80 CM

B RECTANGULAR CHASSIS CHÂSSIS RECTANGULAIRE CHASIS RECTANGULAR

MEASUREMENTS MESURES // MEDIDA
130 x 130 CM



bellian®
HYDROMASSAGE
HYDROMASSAGE
HIDROMASAJE

The hydromassage is a treatment of ancestral origins that combines the action of air and water and produces several positive effects on the body. In particular, hydromassage improves blood circulation, reinvigorates the tissues and strengthens the muscles. Involving the body and mind, this experience means to be better prepared to face the demands of everyday life. Enjoy the comfort of your own home and benefit moments of pure relaxation with Bellian hydromassage systems.

L'hydromassage est un traitement des origines ancestrales qui combine l'action de l'air et l'eau et produit plusieurs effets positifs sur le corps. En particulier, l'hydromassage améliore la circulation sanguine, revigore les tissus et renforce les muscles. Impliquant le corps et l'esprit, cela signifie de l'expérience d'être mieux préparés pour faire face aux exigences de la vie quotidienne. Profitez du confort de votre maison et de moments de pure relaxation avec systèmes d'hydromassage Bellian.

El hidromasaje es un tratamiento de origen ancestral que combina la acción del aire y el agua y produce muchos efectos positivos en el cuerpo. En particular, el hidromasaje mejora la circulación sanguínea, fortalece los tejidos y tonifica los músculos. Afectando cuerpo y mente, esta experiencia significa estar mejor preparado para hacer frente a las exigencias de la vida cotidiana. Disfrute de la comodidad de su casa y disfrute momentos de relajación total con las columnas de hidromasaje Bellian®.



- *Stainless steel frame*
- *2 jet areas*
- *Head shower*
- *Hand shower*
- *Single lever mixer*
- *Stainless steel shower tray 80x80 cm*
- *Shower dock*
- *Does not include water drainage system*

- *Corps en acier inox brossé*
- *2 zone jets*
- *Douche fixe*
- *Douche de main*
- *Mitigeur*
- *Receveur de douche en inox 80x 80 cm*
- *Plateforme*
- *N'inclut pas système pour drainer l'eau*

- *Cuerpo de acero inoxidable*
- *2 zonas de jets*
- *Ducha Fijo*
- *Ducha de mano de latón cromado*
- *Monomando*
- *El acero inoxidable plato de ducha 80x80cm*
- *Deque*
- *No incluye sistema de escurrimiento*

HYDROMASSAGE COLUMN
COLONNE HYDROMASSAGE // COLUMNA DE HIDROMASAJE
 MEASUREMENTS // MESURES // MEDIDAS

15 x 210 CM



- *Stainless steel black body*
- *2 head shower*
- *Brass chromed hand shower*
- *2 massage jets*
- *Mixer*

- *Corps en acier inox noir*
- *2 douche supérieure douche*
- *Douche à main laiton chromé*
- *2 jets massage*
- *Mitigeur*

- *Cuerpo en acero inoxidable negro*
- *2 duchas superiores*
- *Ducha de mano de latón cromado*
- *2 jets de masaje*
- *Monomando*

HYDROMASSAGE COLUMN
COLONNE HYDROMASSAGE // COLUMNA DE HIDROMASAJE
MEASUREMENTS // MESURES // MEDIDAS

20 x 155 CM



- *Brushed stainless steel body*
- *Head shower*
- *Chromed hand shower*
- *3 massage jets*
- *Mixer*
- *Cascade head shower*

- *Corps en acier inox brossé*
- *Douche supérieure*
- *Douche à main chromé*
- *3 jets de massage*
- *Mitigeur*
- *Douche cascade*

- *Cuerpo en acero inoxidable cepillado*
- *Ducha superior*
- *Ducha de mano de latón cromado*
- *3 chorros de masaje*
- *Monomando*
- *Ducha cascada*

HYDROMASSAGE COLUMN
COLONNE HYDROMASSAGE // COLUMNA DE HIDROMASAJE
MEASUREMENTS // MESURES // MEDIDAS

20 x 160 CM





- Brushed stainless steel body
- Head shower
- Chromed brass hand shower
- 6 chromed brass massage jets
- Mixer
- Cascade head shower

- Corps en acier inox brossé
- Douche supérieure
- Douche à main laiton
- 6 jets de massage laiton chromé
- Mitigeur
- Douche cascade

- Cuerpo de acero inoxidable cepillado
- Cabeza de ducha
- Ducha de mano de latón cromado
- 6 jets de masaje latón cromado
- Monomando
- Ducha de la cabeza de la cascada

HYDROMASSAGE COLUMN
COLONNE HYDROMASSAGE // COLUMNA DE HIDROMASAJE
 MEASUREMENTS // MESURES // MEDIDAS

22 x 165 CM



- Brushed stainless steel body
- 2 head shower
- Chromed hand shower
- 4 massage jets
- Mixer

- Corps en acier inox brossé
- 2 douches supérieure
- Douche à main chromé
- 4 jets de massage
- Mitigeur

- Cuerpo en acero inoxidable cepillado
- 2 duchas superiores
- Ducha de mano de latón cromado
- 4 jets de masaje
- Monomando

HYDROMASSAGE COLUMN
COLONNE HYDROMASSAGE // COLUMNA DE HIDROMASAJE
 MEASUREMENTS // MESURES // MEDIDAS

18 x 155 CM



- Grey PPMA-ABS body with white tempered glass
- Head shower
- Chromed hand shower
- 3 massage jets
- Mixer

- Corps en PPMA-ABS gris, avec face avant en verre
- Douches supérieure
- Douche à main laiton chromé
- 3 jets de massage
- Mitigeur

- Cuerpo en acero inoxidable cepillado
- Ducha superior
- Ducha de mano de latón cromado
- 3 jets de masaje
- Monomando
- Ducha cascada

HYDROMASSAGE COLUMN
COLONNE HYDROMASSAGE // COLUMNA DE HIDROMASAJE

MEASUREMENTS // MESURES // MEDIDAS

25 x 155 CM



- Lacquered aluminium body
- Head shower
- Chromed hand shower
- 3 massage jets
- Mixer

- Corps en aluminium laqué
- Douche supérieure
- Douche à main laiton chromé
- 3 jets de massage
- Mitigeur

- Cuerpo de aluminio lacado en blanco
- 1 ducha superior
- Ducha mano del cromo
- 3 jets de masaje
- Monomando

HYDROMASSAGE COLUMN
COLONNE HYDROMASSAGE // COLUMNA DE HIDROMASAJE

MEASUREMENTS // MESURES // MEDIDAS

20 x 155 CM



SANITARY WARE

Bellian® sanitary ware have been designed to give you maximum comfort, combining quality materials with excellent performance and unmatched aesthetics. We express the authenticity in our designs, giving efficient performance with the harmony and simplicity of the quality materials used.

APPAREILS SANITAIRES

Les appareils sanitaires Bellian® ont été conçus pour vous donner le maximum du confort, alliant la qualité des matériaux utilisés à l'excellente performance et l'esthétique inégalée de chaque pièce Bellian®. Nous exprimons l'authenticité dans la pureté de la forme, accordant un accomplissement efficace avec l'harmonie et la simplicité de la qualité des matériaux utilisés.

CERÁMICA SANITARIA

Los sanitarios Bellian® están diseñados para ofrecer el máximo confort, combinando materiales de alta calidad con un excelente rendimiento y la estética única de cada pieza Bellian®.

Expresamos la autenticidad en la pureza de la forma, dando un desempeño eficiente entre la perfecta armonía y la sencillez de la calidad de los materiales utilizados.

TOILET SEATS **SOFT CLOSE**

The Bellian® toilet seats equipped with damped closing system "Soft close", ensure optimum reliability in daily use and provide the utmost comfort in your bathroom. The special hinges in which are fitted provide a progressive fall of the top, giving greater durability while ensuring a smooth and safer use.

ABATTANTS WC **SOFT CLOSE**

Les abattants des toilettes équipés avec le système de fermeture amortie "Soft Close" Bellian®, assurent une fiabilité optimale dans une utilisation quotidienne et offrent le confort maximum dans votre espace de bain.

Les charnières spéciales qui les équipent ont une chute progressive du abattant, ce que lui donne une plus grande durabilité tout en assurant une utilisation souple et plus sûr pour l'utilisateur.

ASIENTOS DE INODORO **SOFT CLOSE**

Los asientos de inodoro están equipadas con sistema de cierre amortiguado "Soft Close" de Bellian®, garantizan una óptima fiabilidad en el uso diario y proporcionan el mayor confort en su espacio de baño.

Las bisagras especiales con que son equipados, proporcionan una caída progresiva de la parte superior, dando una mayor durabilidad al tiempo que garantiza un uso cómodo y más seguro para el usuario.



bellian®
SANITARY WARE
APPAREILS SANITAIRES
SANITARIOS





WALL-HUNG WASHBASIN
LAVABO SUSPENDU // LAVABO SUSPENDIDO

WHITE // BLANC
BLANCO



WALL-HUNG WC
TOILETTE SUSPENDU // INODORO SUSPENDIDO

W/ DUROPLAST SOFT CLOSE TOILET SEAT COVER AND FIXING KIT
A/ ABATTANT DUROPLAST SOFT CLOSE ET KIT DE FIXATION
C/ ASSIENTO WC DUROPLAST Y KIT DE FIJACIÓN

W/ POLYPROPYLENE SOFT CLOSE TOILET SEAT COVER AND FIXING KIT
A/ ABATTANT POLYPROPYLENE SOFT CLOSE ET KIT DE FIXATION
C/ ASSIENTO WC POLIPROPILENO Y KIT DE FIJACIÓN

WHITE // BLANC
BLANCO



WALL-HUNG BIDET
BIDET SUSPENDU // BIDÉ SUSPENDIDO

W/ FIXING KIT
A/ KIT DE FIXATION
C/ KIT DE FIJACIÓN

WHITE // BLANC
BLANCO

TOILET SEATS ABATTANTS ASIENTOS WC



DUROPLAST



POLYPROPYLENE // POLYPROPYLENE
POLIPROPILENO



COMPACT S-TRAP OR P-TRAP TOILET
CUVETTE COMPACT S/V OU S/H
INODORO COMPACTO SALIDA DUAL

W/ DUROPLAST SOFT CLOSE TOILET SEAT COVER, DOUBLE FLUSH SYSTEM AND FIXING KIT
A/ ABATTANT DUROPLAST SOFT CLOSE, MECANISME DOUBLE DÉCHARGE ET KIT DE FIXATION
C/ ASSIENTO WC DUROPLAST, MECANISMO DE DOBLE DESCARGA Y KIT DE FIJACIÓN

W/ POLYPROPYLENE SOFT CLOSE TOILET SEAT COVER, DOUBLE FLUSH SYSTEM AND FIXING KIT
A/ ABATTANT POLYPROPYLENE SOFT CLOSE, MECANISME DOUBLE DÉCHARGE ET KIT DE FIXATION
C/ ASSIENTO WC POLIPROPILENO, MECANISMO DE DOBLE DESCARGA Y KIT DE FIJACIÓN

WHITE // BLANC
BLANCO

S-TRAP FLOOR OUTLET OR P-TRAP WALL OUTLET
S/V SORTIE VERTICAL OU S/H SORTIE HORIZONTAL
SALIDA A PARED O SALIDA A SUELO



BIDET // BIDET // BIDÉ

W/ FIXING KIT
A/ KIT DE FIXATION
C/ KIT DE FIJACIÓN

WHITE // BLANC
BLANCO



**TOILET SEATS
ABATTANTS
ASIENTOS WC**



DUROPLAST



POLYPROPYLENE // POLYPROPYLENE
POLIPROPILENO



COUNTERTOP WASHBASIN
VASQUE À POSER // LAVABO DE POSAR

WHITE // BLANC
BLANCO



WALL-HUNG WC
TOILETTE SUSPENDU // INODORO SUSPENDIDO

W/ DUROPLAST SOFT CLOSE TOILET SEAT COVER AND FIXING KIT
A/ ABATTANT DUROPLAST SOFT CLOSE ET KIT DE FIXATION
C/ ASSIETTE WC DUROPLAST Y KIT DE FIJACIÓN

W/ PP SOFT CLOSE TOILET SEAT COVER AND FIXING KIT
A/ ABATTANT POLYPROPYLENE SOFT CLOSE ET KIT DE FIXATION
C/ ASSIETTE WC POLIPROPILENO Y KIT DE FIJACIÓN

WHITE // BLANC
BLANCO



WALL-HUNG BIDET
BIDET SUSPENDU // BIDÉ SUSPENDIDO

W/ FIXING KIT
A/ KIT DE FIXATION
C/ KIT DE FIJACIÓN

WHITE // BLANC
BLANCO



WALL-HUNG WC // TOILETTE SUSPENDU // INODORO SUSPENDIDO

W/ DUROPLAST SOFT CLOSE TOILET SEAT COVER AND FIXING KIT
 A/ ABATTANT DUROPLAST SOFT CLOSE ET KIT DE FIXATION
 C/ ASSIENNE WC DUROPLAST Y KIT DE FIJACIÓN

WHITE // BLANC
 BLANCO



WALL-HUNG BIDET // BIDET SUSPENDU // BIDÉ SUSPENDIDO

W/ FIXING KIT
 A/ KIT DE FIXATION
 C/ KIT DE FIJACIÓN

WHITE // BLANC
 BLANCO



**COMPACT S-TRAP OR P-TRAP TOILET
 CUVETTE COMPACT S/V OU S/H
 INODORO COMPACTO SALIDA DUAL**

W/ DUROPLAST SOFT CLOSE TOILET SEAT COVER, DOUBLE FLUSH SYSTEM AND FIXING KIT
 A/ ABATTANT DUROPLAST SOFT CLOSE, MECANISME DOUBLE DÉCHARGE ET KIT DE FIXATION
 C/ ASSIENNE WC DUROPLAST, MECANISMO DE DOBLE DESCARGA Y KIT DE FIJACIÓN

WHITE // BLANC
 BLANCO

S-TRAP FLOOR OUTLET OR P-TRAP WALL OUTLET
 S/V SORTIE VERTICALE OU S/H SORTIE HORIZONTAL
 SALIDA A PARED O SALIDA A SUELO



BIDET // BIDET // BIDÉ

W/ FIXING KIT
 A/ KIT DE FIXATION
 C/ KIT DE FIJACIÓN

WHITE // BLANC
 BLANCO



WALL-HUNG WC // TOILETTE SUSPENDU // INODORO SUSPENDIDO

W/ DUROPLAST SOFT CLOSE TOILET SEAT COVER AND FIXING KIT
 A/ ABATTANT DUROPLAST SOFT CLOSE ET KIT DE FIXATION
 C/ ASSIENNE WC DUROPLAST Y KIT DE FIJACIÓN

WHITE // BLANC
 BLANCO

WALL-HUNG BIDET // BIDET SUSPENDU // BIDÉ SUSPENDIDO

W/ FIXING KIT
 A/ KIT DE FIXATION
 C/ KIT DE FIJACIÓN

WHITE // BLANC
 BLANCO



COMPACT S-TRAP OR P-TRAP TOILET
 CUVETTE COMPACT S/V OU S/H
 INODORO COMPACTO SALIDA DUAL

W/ DUROPLAST SOFT CLOSE TOILET SEAT COVER, DOUBLE FLUSH SYSTEM AND FIXING KIT
 A/ ABATTANT DUROPLAST SOFT CLOSE, MECANISME DOUBLE DÉCHARGE ET KIT DE FIXATION
 C/ ASSIENNE WC DUROPLAST, MECANISMO DE DOBLE DESCARGA Y KIT DE FIJACIÓN

WHITE // BLANC
 BLANCO

S-TRAP FLOOR OUTLET OR P-TRAP WALL OUTLET
 S/V SORTIE VERTICALE OU S/H SORTIE HORIZONTALE
 SALIDA A PARED O SALIDA A SUELO

BIDET // BIDET // BIDÉ

W/ FIXING KIT
 A/ KIT DE FIXATION
 C/ KIT DE FIJACIÓN

WHITE // BLANC
 BLANCO



WALL-HUNG WC // TOILETTE SUSPENDU // INODORO SUSPENDIDO

W/ DUROPLAST SOFT CLOSE TOILET SEAT COVER AND FIXING KIT
 A/ ABATTANT DUROPLAST SOFT CLOSE ET KIT DE FIXATION
 C/ ASSIENNE WC DUROPLAST Y KIT DE FIJACIÓN

WHITE // BLANC
 BLANCO

WALL-HUNG BIDET // BIDET SUSPENDU // BIDÉ SUSPENDIDO

W/ FIXING KIT
 A/ KIT DE FIXATION
 C/ KIT DE FIJACIÓN

WHITE // BLANC
 BLANCO



**COMPACT S-TRAP OR P-TRAP TOILET
 CUVETTE COMPACT S/V OU S/H
 INODORO COMPACTO SALIDA DUAL**

W/ DUROPLAST SOFT CLOSE TOILET SEAT COVER, DOUBLE FLUSH SYSTEM AND FIXING KIT
 A/ ABATTANT DUROPLAST SOFT CLOSE, MECANISME DOUBLE DÉCHARGE ET KIT DE FIXATION
 C/ ASSIENNE WC DUROPLAST, MECANISMO DE DOBLE DESCARGA Y KIT DE FIJACIÓN

WHITE // BLANC
 BLANCO

S-TRAP FLOOR OUTLET OR P-TRAP WALL OUTLET
 S/V SORTIE VERTICALE OU S/H SORTIE HORIZONTALE
 SALIDA A PARED O SALIDA A SUELO

BIDET // BIDET // BIDÉ

W/ FIXING KIT
 A/ KIT DE FIXATION
 C/ KIT DE FIJACIÓN

WHITE // BLANC
 BLANCO

**WASHBASIN // LAVABO // LAVABO**

60 X 49 CM

WHITE // BLANC
BLANCO

**MANUAL ADJUSTMENT WASHBASIN SUPPORT**

SUPPORT POUR LAVABO RÉGLAGE MANUEL // SOPORTE LAVABO AJUSTE MANUAL

STAINLESS STEEL
ACIER INOXYDABLE
ACERO INOXIDABLE

WHITE
BLANC
BLANCO

**URINAL // URINOIR // URINARIO**

WHITE // BLANC
BLANCO

**TOILET // CUVETTE // INODORO**

COMPACT S-TRAP TOILET
CUVETTE COMPACT S/V
INODORO COMPACTO C/ SALIDA A SUELO

COMPACT S-TRAP TOILET
CUVETTE COMPACT S/V
INODORO COMPACTO C/ SALIDA A SUELO

WHITE MARINE PLYWOOD TOILET SEAT COVER
ABATTANT CONTREPLAQUÉ MARINE BLANC
ASSIENTO WC CONTRACHAPADO MARITIMO BLANCO

WHITE DUROPLAST TOILET SEAT COVER
ABATTANT DUROPLAST BLANC
ASSIENTO DUROPLAST BLANCO

SIMPLE FLUSHING MECHANISM
MÉCANISME DE CHASSE SIMPLE
MECANISMO SIMPLES DE DESCARGA

S-TRAP FLOOR OUTLET
S/V SORTIE VERTICALE
SALIDA A SUELO

**RECLINING WASHBASIN SUPPORT**

SUPPORT POUR LAVABO INCLINABLE // SOPORTE LAVABO BASCULANTE

STAINLESS STEEL
ACIER INOXYDABLE
ACERO INOXIDABLE

WHITE
BLANC
BLANCO

**WALL DIVIDER FOR URINAL // SÉPARATEUR D'URINOIR // SEPARADOR PARA URINARIO**

STAINLESS STEEL
ACIER INOXYDABLE
ACERO INOXIDABLE

WHITE
BLANC
BLANCO

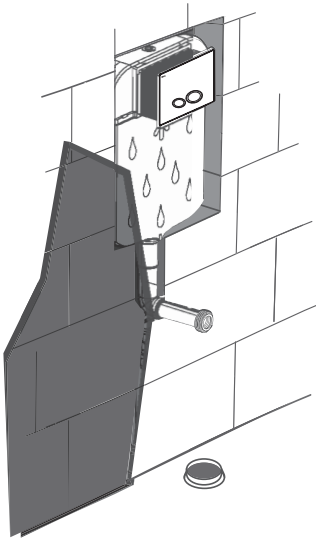

SIMPLE

Is the ideal solution for installation in resistant walls, for sanitary ware installation attachment to the ground.

Est la solution idéale pour l'installation dans les murs robustes, pour l'installation d'appareils sanitaires de fixation au sol.

Es la solución ideal para la instalación en paredes resistentes, para sanitarios fijos al suelo.

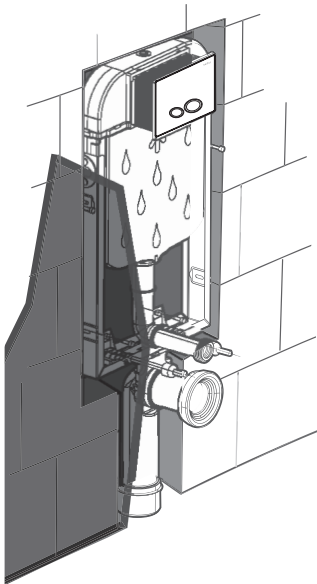

EASY

Easy is the right solution for the installation of sanitary ware in resistant walls, such as brickwalls. Our Easy frames are designed for in-wall application on masonry walls.

Easy est la solution idéale pour l'installation d'appareils sanitaires aux murs résistants. Les systèmes Easy sont conçus pour une facile application encastré dans la maçonnerie.

Easy es la solución adecuada para la instalación de artículos sanitarios en las paredes robustas como la albañilería. Las estructuras Easy están diseñadas para una fácil aplicación incrustado en la albañilería

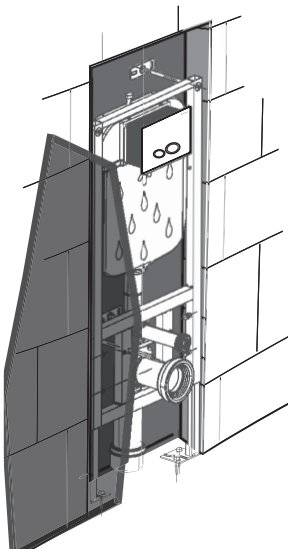

SOLID

Solid is an installation system with high mechanical strength for the installation of sanitary ware in plasterboard walls, ideal for new construction or renovations.

Solid est un système d'installation à haute résistance mécanique, idéal pour l'installation d'appareils sanitaires dans les murs de plâtré, idéal pour les nouvelles constructions ou des rénovations.

Solid es un sistema de instalación de alta resistencia mecánica para la instalación de cerámica sanitaria en las paredes ligeras, ideal para la nueva construcción o remodelación.

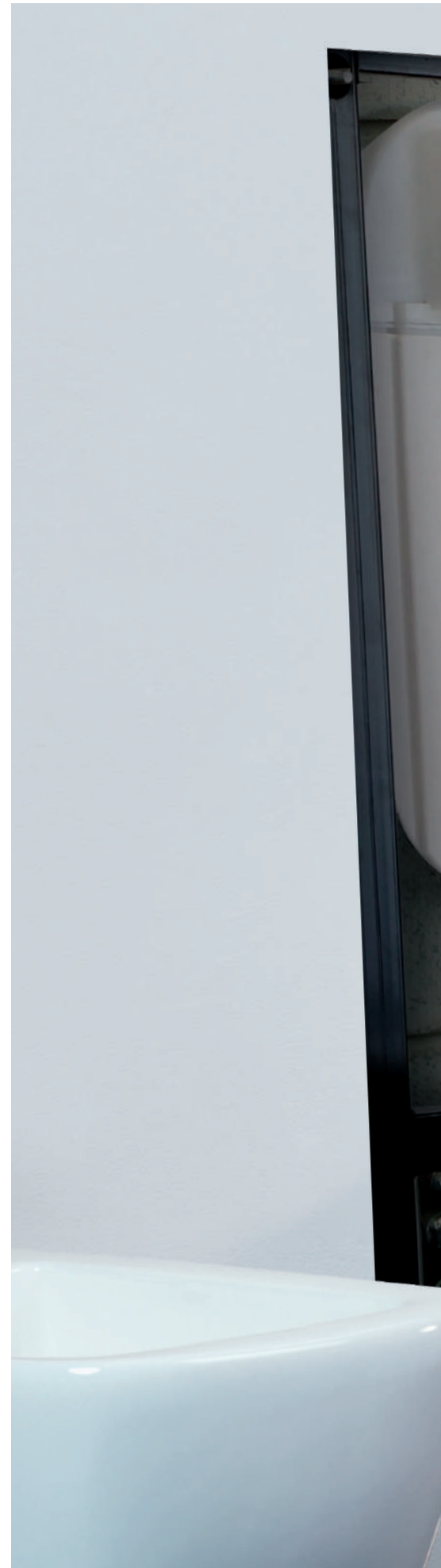



INTERNAL CISTERNS

With the range solutions for in-wall flush cisterns has all the freedom to create your bathroom space with more free space, in a strong engagement between reliability, water efficiency and design.

RESERVOIRS INTÉRIEURES

Avec la gamme de solutions pour réservoirs à encastrer, vous avez toute la liberté pour créer votre espace de salle de bains avec plus d'espace libre, dans une forte compromis entre la fiabilité, l'économie de l'eau et le design.

CISTERNAS EMPOTRADAS

Con la gama de soluciones para cisternas empotradas tiene toda la libertad de crear su espacio de baño con más espacio libre, en un fuerte compromiso entre la fiabilidad, la eficiencia del agua y el diseño.



- Without frame
- Dual flush 3/6l
- Styrofoam coating
- Silent float valve (KIWA, NF)
- Depth 8 cm
- Easy installation and maintenance
- Flush pipe include

- Sans structure
- Double chasse 3/6l
- Revêtement polystyrène
- Robinet flotteur silencieux (KIWA, NF)
- Profondeur 8 cm
- Installation et un entretien faciles
- Tube à décharge inclus

- Sin estructura
- Doble descarga 3 / 6l
- Recubrimiento de espuma de poliestireno
- Válvula de flotador silencioso (KIWA, NF)
- Profundidad 8 cm
- Fácil instalación y mantenimiento
- Incluye tubo de descarga



SIMPLE

CONCEALED CISTERN WITHOUT FRAME
RÉSERVOIR INTÉRIÈRE SANS STRUCTURE
CISTERNA EMPOTRADA SIN ESTRUCTURA



- With frame for strong walls
- Dual flush 3/6l
- Styrofoam coating
- Silent float valve (KIWA, NF)
- Reduced depth
- Easy installation and maintenance
- Flush pipe include

- Avec structure pour murs solides
- Double chasse 3/6l
- Revêtement polystyrène
- Robinet flotteur silencieux (KIWA, NF)
- Profondeur réduit
- Installation et un entretien faciles
- Tube à décharge inclus

- Con estructura para paredes sólidas
- Doble descarga 3 / 6l
- Recubrimiento de espuma de poliestireno
- Válvula de flotador silencioso (KIWA, NF)
- Profundidad reducida
- Fácil instalación y mantenimiento
- Incluye tubo de descarga



EASY

CONCEALED CISTERN WITH FRAME
RÉSERVOIR INTÉRIÈRE AVEC STRUCTURE
CISTERNA EMPOTRADA CON ESTRUCTURA

CONCEALED CISTERN WITH FRAME AND FEET
RÉSERVOIR INTÉRIÈRE AVEC STRUCTURE ET PIEDS
CISTERNA EMPOTRADA CON ESTRUCTURA Y PIES



- Dual flush 3/6l
- Styrofoam coating
- Silent float valve (KIWA, NF)
- Adjustable depth
- Supports up to 400kg
- Easy installation and maintenance
- Flush pipe include

- Double chasse 3/6l
- Revêtement polystyrène
- Robinet flotteur silencieux (KIWA, NF)
- Réglable réduit
- Psoutien jusqu' à 400kg
- Installation et un entretien faciles
- Tube à décharge inclus

- Doble descarga 3 / 6l
- Recubrimiento de espuma de poliestireno
- Válvula de flotador silencioso (KIWA, NF)
- Profundidad ajustable
- Soporta hasta 400 kg
- Fácil instalación y mantenimiento
- Incluye tubo de descarga



SOLID

CONCEALED CISTERN WITH FRAME
RÉSERVOIR INTÉRIÈRE AVEC STRUCTURE
CISTERNA EMPOTRADA CON ESTRUCTURA

- *Metallic structure*
- *Easy installation and maintenance*
- *Adjustable height*
- *Structure métallique*
- *Installation et entretien faciles*
- *Réglable en hauteur*
- *Estructura metálica*
- *Fácil instalación y mantenimiento*
- *Altura ajustable*

SOLID

WALL- HUNG BIDET AND TOILET STRUCTURE
STRUCTURE BIDET ET CUVETTE SUSPENDU
ESTRUTURA PARA BIDÉ O INODORO SUSPENDIDO



- *Metallic structure*
- *Easy installation and maintenance*
- *Adjustable height*
- *Structure métallique*
- *Installation et entretien faciles*
- *Réglable en hauteur*
- *Estructura metálica*
- *Fácil instalación y mantenimiento*
- *Altura ajustable*

EASY

WALL- HUNG BIDET AND TOILET STRUCTURE
STRUCTURE BIDET ET CUVETTE SUSPENDU
ESTRUTURA PARA BIDÉ O INODORO SUSPENDIDO



CONTROL PANELS // PANNEAUX DE CONTRÔLE // PULSADORES

ROUND

- *CHROME*
- *CHROMÉ*
- *CROMADO*
- *MATTE*
- *MATE*
- *MATE*



SQUARE

- *CHROME*
- *CHROMÉ*
- *CROMADO*
- *MATTE*
- *MATE*
- *MATE*







GENERAL CONDITIONS OF SALE

Barros & Moreira and its customers accept the following terms and conditions from the moment that order are formalized:

- 1 | *Order confirmation and delivery are always depending on the availability of stock. Delays in delivery of the order does not require payment of any compensation to the customer.*
- 2 | *All claims must be made within 8 days after the confirmation of delivery of the goods. In case of return, the products must be properly packaged and protected in its original packaging.*
- 4 | *Merchandise remains the property of Barros & Moreira until complete settlement.*
- 5 | *In case of dispute, the competent court is the county of Caldas da Rainha.*

PRECAUTIONS

We reserve the right to make any change without any prior notice, in prices, described materials and specifications.

The measurements are presented for guidance, as well as colours presented in this catalogue may differ from reality, due to printing variations.

CONDITIONS GÉNÉRALES DE VENTE

Barros & Moreira, S.A. et leurs clients acceptent les conditions de vente suivantes, à partir du moment de la formalisation de l'ordre:

- 1 | *La confirmation de la commande et du terme de la livraison sont toujours soumises à la disponibilité de stock.*
- 2 | *Les retards dans la livraison des commandes n'impliquent aucune indemnisation pour le client.*
- 3 | *Toutes les réclamations doivent être faites dans les 8 jours après la confirmation de la livraison de la marchandise. En cas de retour, les produits doivent être convenablement emballés et protégés dans son emballage original.*
- 4 | *La marchandise reste propriété de "Barros & Moreira" jusqu'à règlement complet.*
- 5 | *En cas de litige, le tribunal compétent est le comité de Caldas da Rainha.*

AVERTISSEMENTS

Nous nous réservons dans le droit d'apporter quelque modification sans préavis, aux prix, aux matériaux ou à les spécifications décrites.

Les mesures sont présentés à titre indicatif, ainsi que les couleurs dans cette brochure peuvent différer de la réalité, en raison des variations d'impression.

CONDICIONES GENERALES DE VENTA

La Barros y Moreira, SA y sus clientes aceptan las siguientes condiciones de venta desde el momento de formalizar el pedido:

1. El precio de esta tabla puede cambiar sin previo aviso. Los precios son presentados sin IVA a la tasa legal.
2. La confirmación de la orden y el tiempo de entrega siempre depende de la disponibilidad de stock.
No está sujeto a ningún tipo de compensación al cliente debido a la demora en la entrega de los pedidos.
3. Todas las reclamaciones deben hacerse dentro de 8 días después de la confirmación de la entrega de la mercancía. En caso de devolución, los productos deben estar debidamente asegurados y protegidos en su embalaje original.
4. La mercancía es propiedad de Barros y Moreira, SA, hasta su liquidación total.
5. En caso de litigio, el tribunal competente es el de Caldas da Rainha.

PRECAUCIONES

Nos reservamos el derecho de efectuar cualquier modificación sin previo aviso, en los precios, las especificaciones y materiales descritos. Los precios mostrados anulan los anteriores y son válidos salvo error tipográfico.

Las medidas presentadas son de carácter orientativo, así como los colores en este folleto pueden variar de la realidad debido a las variaciones de impresión.



Taps and Accessories
Robinetterie et Accessoires
Grifería y Accesorios

bellian®

Furniture, Sanitaryware and Shower Enclosures
Meubles, Appareils Sanitaires et Cabines de Douche
Muebles, Cerámica Sanitária y Mamparas de Baño



barros & moreira, sa

Rua Industrial nº8
Zona Industrial da Ponte Seca
2510-752 Gaeiras - Óbidos
Portugal

geral@grupobm.pt
www.grupobm.pt
telf.: (+351) 262 837 230
fax: (+351) 262 837 231

ISO 9001
BUREAU VERITAS
Certification



Cofinanciado por:



UNIÃO EUROPEIA
Fundos Europeus
Estruturais e de Investimento