

ARIUS<sup>®</sup>

H O M E

ITALY

... guardare  
toccare  
muovere  
ruotare  
spingere  
tirare ...

... look  
touch  
move  
rotate  
push  
pull ...

# ARIUS<sup>®</sup>

H O M E

*Immagina la tua casa ...*

*Imagine your home ...*

**ARIUS HOME** by Glass Design SRL, è un'eccellenza italiana nella produzione e design di maniglie d'arredo e accessori per il mobile. Situata a Vinci, cuore della Toscana e città di Leonardo da Vinci, la Glass Design è stata fondata nel 1984 dalla famiglia Borsellini dopo una pluriennale esperienza nella manifattura del vetro artistico.

Lavorando ad arte su materiali tradizionali come il cristallo 24% Pb molato o il vetro di Murano, **ARIUS HOME** rappresenta un nuovo stile dove l'accessorio, curato nei minimi dettagli, diventa il soggetto principale dell'ambiente, un vero prodotto di moda apprezzato nel mondo ed esportato in più di 60 paesi.

Oltre duecento artigiani toscani ed una quindicina di vetrai muranesi appartengono alla filiera lavorativa aziendale.

La gamma di prodotti **ARIUS HOME** include maniglie d'arredo, accessori per mobili, portabiti, coprinterruttori, tutti coordinabili per forme e colori.

**ARIUS HOME** costituisce il punto più alto di un cammino artigianale e tecnologico, che investe con saggezza imprenditoriale il ricco patrimonio culturale della lavorazione del cristallo.

***ARIUS HOME** by Glass Design SRL, is an Italian excellence in the production and design of door handles and furniture accessories.*

*Located in Vinci, in the heart of Tuscany and native town of "Leonardo da Vinci", Glass Design was founded in 1984 by the Borsellini family, further to a long tradition in manufacturing artistic glass.*

*By working in an artistic way with traditional materials like the formed 24% Pb crystal and the "Murano" glass, **ARIUS HOME** contributes to the creation of a new style, where even the accessory is addressed in all details, becoming the main subject of the environment, a true "fashion" product, highly appreciated in the world and exported to more than 60 countries.*

*Over 200 Tuscan artisans and more than 15 glassmakers of Murano work within the company's production chain.*

*The **ARIUS HOME** product range includes: door handles, furniture accessories, coat hangers, switch covers, everything conceived to be combined in terms of shape, style and colours. **ARIUS HOME** is the highest point of a craftsman and technological path which invests with wisdom the rich cultural patrimony of the crystal workmanship.*

Crystal since 1949

INDICE *INDEX*

MANIGLIE E POMOLI PER PORTA  
*DOOR HANDLES / DOOR KNOBS*  
PULL & PUSH

8



POMOLI  
*KNOBS*

56



MANIGLIONI *PULL HANDLES*  
MANIGLIETTE *FURNITURE HANDLES*  
PORTABITI *COAT HANGERS*  
COPRINTERRUTTORI *SWITCH COVERS*

80



SCHEDE  
*DATA SHEET*

90



**MANIGLIE E POMOLI PER PORTA**  
*DOOR HANDLES / DOOR KNOBS*  
**PULL & PUSH**



# ICE

Cristallo  
**DE' MEDICI**  
Pb 24%

*... scultorea ...*  
*... sculptural ...*

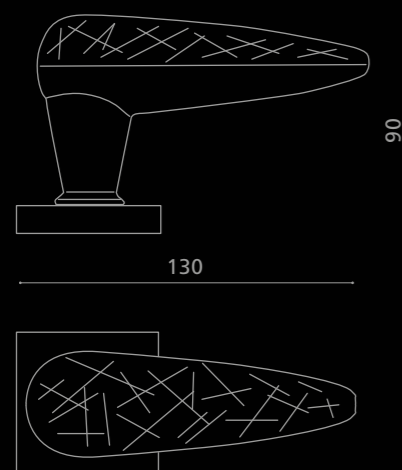

Fori chiave disponibili / Available key holes

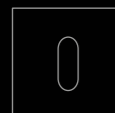

PATENT

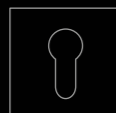

YALE

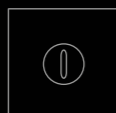

WC

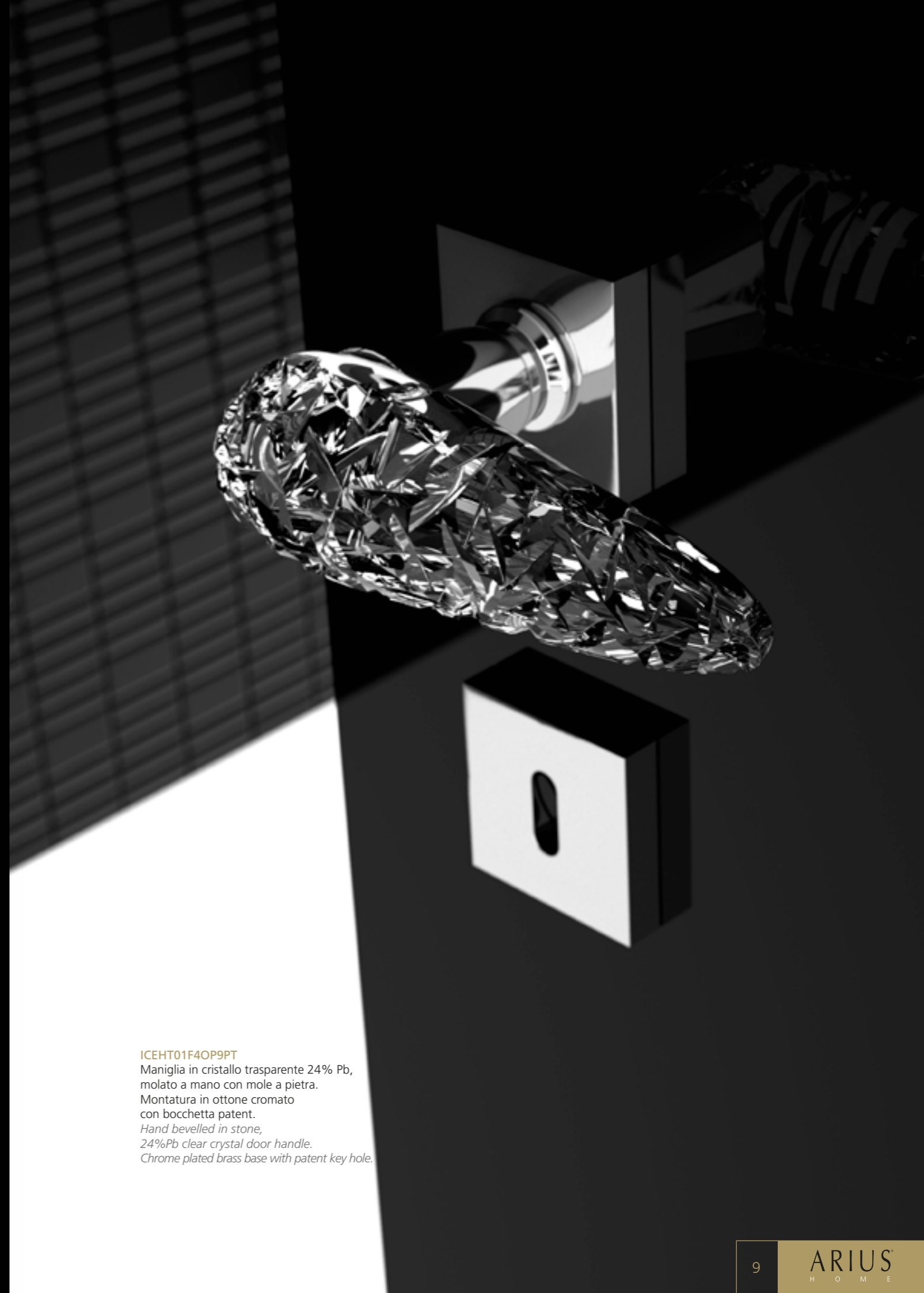
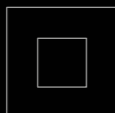

**ICEHT01F4OP9PT**

Maniglia in cristallo trasparente 24% Pb,  
molato a mano con mole a pietra.

Montatura in ottone cromato  
con bocchetta patent.

*Hand bevelled in stone,  
24%Pb clear crystal door handle.*

*Chrome plated brass base with patent key hole.*

# LUXOR

Cristallo  
**DE' MEDICI**  
Pb 24%

*... prestigiosa ...*  
*... prestigious ...*

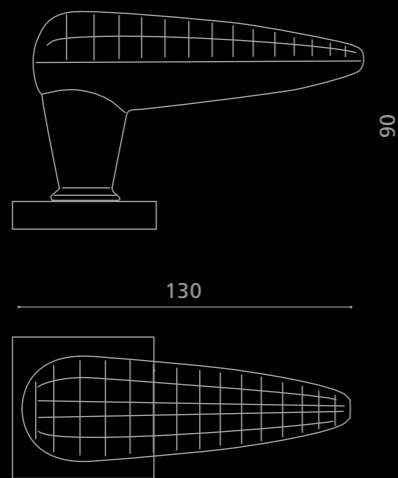

Fori chiave disponibili / Available key holes

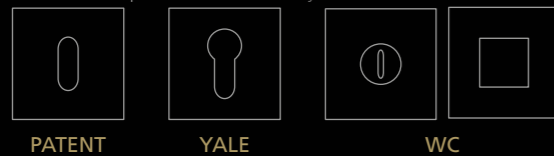

**LUXORHT01F40P9PT**

Maniglia in cristallo trasparente 24% Pb, molato a mano con mole a pietra. Montatura in ottone cromato con bocchetta patent.  
Hand bevelled in stone, 24%Pb clear crystal door handle.  
Chrome plated brass base with patent key hole.

# DIAMOND Q

Cristallo  
DE' MEDICI®  
Pb 24%



**DIAMONDQT35F40P9PT**  
Pomolo per porta in cristallo nero,  
molato a mano con mole a pietra.  
Montatura in ottone cromato con bocchetta patent.  
*Hand bevelled in stone, black crystal door knob.  
Chrome plated brass base with patent key hole.*

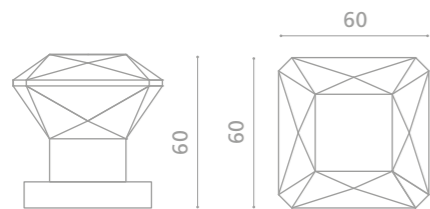

Fori chiave disponibili / Available key holes

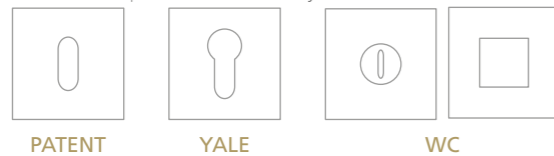

**DIAMONDQT01F10P9PT**  
Pomolo per porta in cristallo trasparente,  
molato a mano con mole a pietra.  
Montatura in ottone lucido con bocchetta patent.  
*Hand bevelled in stone, clear crystal door knob. Polished brass  
base with patent key hole.*

*... un gioiello ...*  
*... a jewel ...*

# ROUND Home

Cristallo  
DE' MEDICI<sup>®</sup>  
Pb 24%

design by **MrSmith** Studio

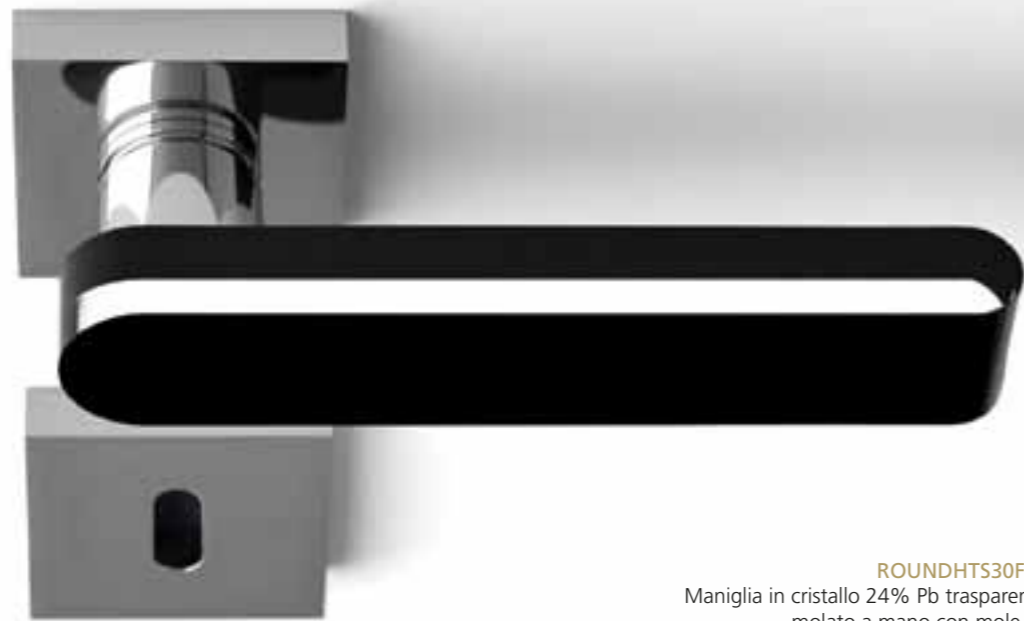

**ROUNDHTS30F4OP9PT**  
Maniglia in cristallo 24% Pb trasparente/nero,  
molato a mano con mole a pietra.  
Montatura in ottone cromato con bocchetta patent  
*Hand bevelled in stone, 24%Pb clear/black crystal door handle.*  
*Chrome plated brass base with patent key hole.*

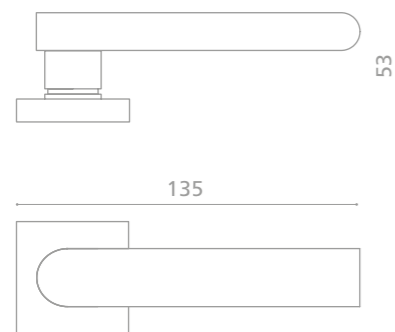

Fori chiave disponibili / Available key holes

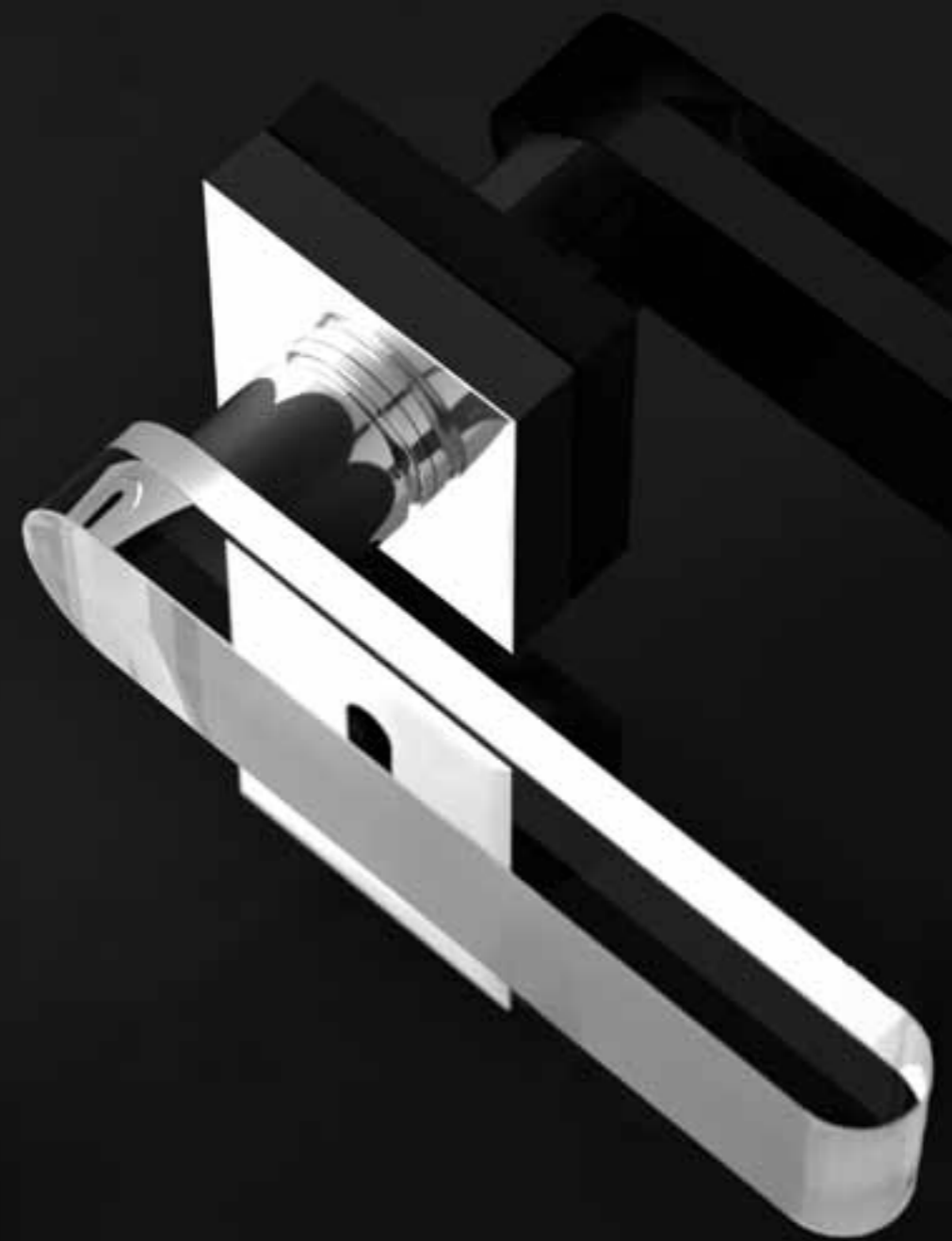
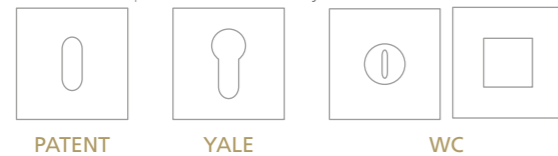

*... inconfondibile ...*  
*... unmistakable ...*

**ROUNDHTS01F4OP9PT**  
Maniglia in cristallo trasparente/sabbiato 24% Pb,  
molato a mano con mole a pietra.  
Montatura in ottone cromato con bocchetta patent.  
*Hand bevelled in stone, 24%Pb clear/mat crystal door handle.*  
*Chrome plated brass base with patent key hole.*

*... pura ...*  
*... pure ...*



Fori chiave disponibili / Available key holes

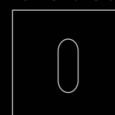

PATENT

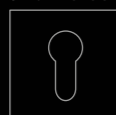

YALE

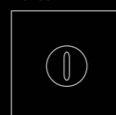

WC

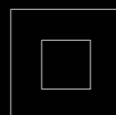

KYMIHT01F4OP9PT

Maniglia in cristallo trasparente/sabbiato 24% Pb,  
molato a mano con mole a pietra.

Montatura in ottone cromato con bocchetta patent.

Hand bevelled in stone, 24%Pb clear/mat crystal door handle.

Chrome plated brass base with patent key hole.



*... intrigante ...*  
*... intriguing ...*

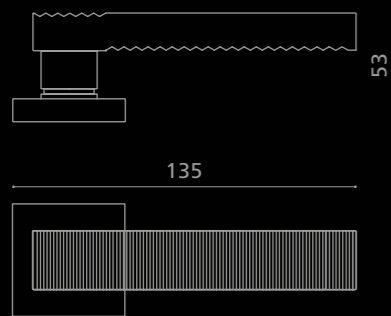

Fori chiave disponibili / Available key holes

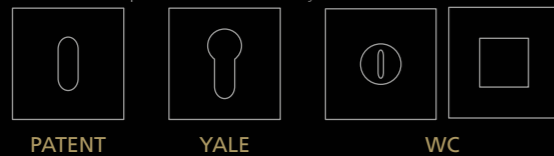

**KOSHT01F10P9PT**

Maniglia in cristallo trasparente 24% Pb, molato a mano con mole a pietra.  
Montatura in ottone lucido con bocchetta patent.  
Hand bevelled in stone, 24%Pb clear crystal door handle.  
Polished brass base with patent key hole.



**KEAHT01F4OP9**  
Maniglia in cristallo trasparente 24% Pb, molato a mano con mole a pietra.  
Montatura in ottone cromato.  
*Hand bevelled in stone, 24%Pb clear crystal door handle.  
Chrome plated brass base.*

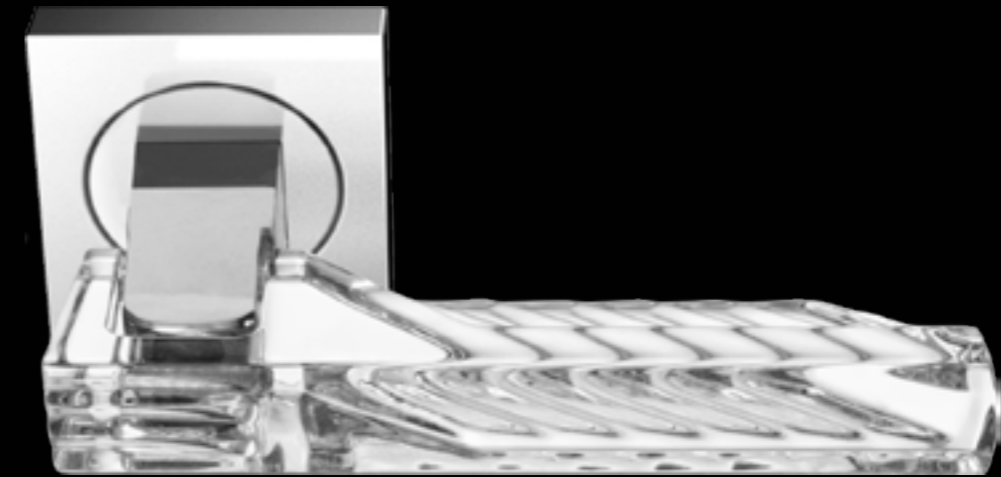

**ARKADHT01F4OP9**  
Maniglia in cristallo trasparente 24% Pb, molato a mano con mole a pietra.  
Montatura in ottone cromato.  
*Hand bevelled in stone, 24%Pb clear crystal door handle.  
Chrome plated brass base.*

**KEAHS01F4OP9**  
Maniglia in cristallo satinato 24% Pb, molato a mano con mole a pietra. Montatura in ottone cromato.  
*Hand bevelled in stone, 24%Pb mat crystal door handle.  
Chrome plated brass base.*



**KEAHT05F4OP9**  
Maniglia in cristallo ambra 24% Pb, molato a mano con mole a pietra. Montatura in ottone cromato.  
*Hand bevelled in stone, 24%Pb amber crystal door handle.  
Chrome plated brass base.*



**ARKADHT05F4OP9**  
Maniglia in cristallo ambra 24% Pb, molato a mano con mole a pietra. Montatura in ottone cromato.  
*Hand bevelled in stone, 24%Pb amber crystal door handle.  
Chrome plated brass base.*

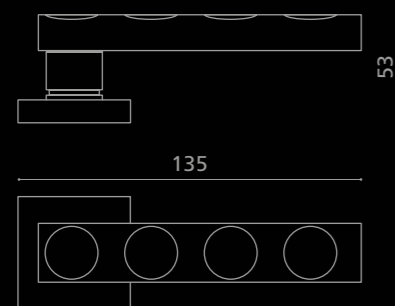

Fori chiave disponibili / Available key holes

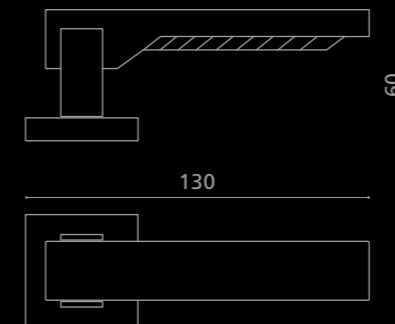

Fori chiave disponibili / Available key holes

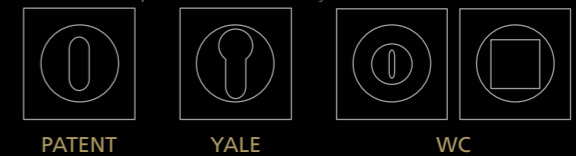

# CUBE

Cristallo  
**DE' MEDICI**  
Pb 24%



**CUBET36F1OP9WC**  
Maniglia in cristallo bianco latte, molato a mano con mole a pietra.  
Montatura in ottone lucido con nottolino WC.  
*Hand bevelled in stone, white crystal door handle.  
Polished brass base with WC key set.*

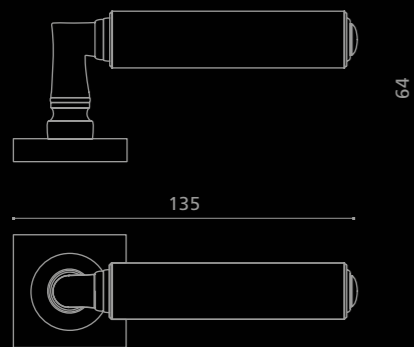

Fori chiave disponibili / Available key holes



PATENT

YALE

WC



**CUBET35F4OP9WC**  
Maniglia in cristallo opale nero, molato a mano con mole a pietra.  
Montatura in ottone cromato con nottolino WC.  
*Hand bevelled in stone, black crystal door handle.  
Chrome plated brass base with WC key set.*

... *unica* ...

... *unique* ...



# WIND

Cristallo  
DE' MEDICI®  
Pb 24%



## WINDT01F4OP2

Maniglia in cristallo trasparente 24% Pb, molato a mano con mole a pietra.  
Montatura in ottone cromato.  
*Hand bevelled in stone, 24%Pb clear crystal door handle.  
Chrome plated brass base.*

# KIARA

Cristallo  
DE' MEDICI®  
Pb 24%



## KIARAT01F4OP2

Maniglia in cristallo trasparente 24% Pb, molato a mano con mole a pietra.  
Montatura in ottone cromato.  
*Hand bevelled in stone, 24%Pb clear crystal door handle.  
Chrome plated brass base.*

**WINDS01F4OP2**  
Maniglia in cristallo satinato 24% Pb,  
molato a mano con mole a pietra. Montatura in ottone cromato.  
*Hand bevelled in stone, 24%Pb mat crystal door handle.  
Chrome plated brass base.*



**WINDT05F1OP2**  
Maniglia in cristallo ambra 24% Pb,  
molato a mano con mole a pietra. Montatura in ottone lucido.  
*Hand bevelled in stone, 24%Pb amber crystal door handle.  
Polished brass base.*



**KIARAS01F4OP2**  
Maniglia in cristallo satinato 24% Pb,  
molato a mano con mole a pietra. Montatura in ottone cromato.  
*Hand bevelled in stone, 24%Pb mat crystal door handle.  
Chrome plated brass base.*



**KIARAT05F1OP2**  
Maniglia in cristallo ambra 24% Pb,  
molato a mano con mole a pietra. Montatura in ottone lucido.  
*Hand bevelled in stone, 24%Pb amber crystal door handle.  
Polished brass base.*

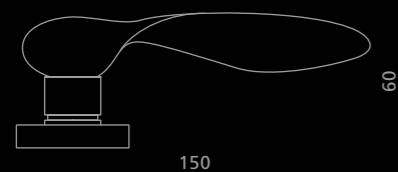

Fori chiave disponibili / Available key holes

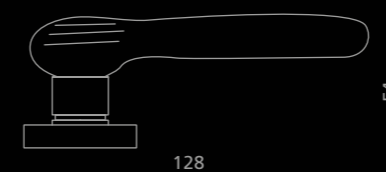

Fori chiave disponibili / Available key holes





**OKAHT01F4OP9**  
Maniglia in cristallo trasparente 24% Pb, molato a mano con mole a pietra.  
Montatura in ottone cromato.  
*Hand bevelled in stone, 24%Pb clear crystal door handle.  
Chrome plated brass base.*

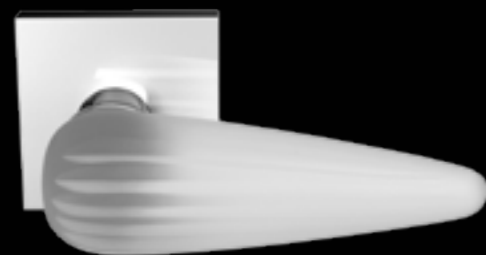

**OKAHS01F4OP9**  
Maniglia in cristallo satinato 24% Pb, molato a mano con mole a pietra. Montatura in ottone cromato.  
*Hand bevelled in stone, 24%Pb mat crystal door handle.  
Chrome plated brass base.*



**OKAHT05F1OP9**  
Maniglia in cristallo ambra 24% Pb, molato a mano con mole a pietra. Montatura in ottone lucido.  
*Hand bevelled in stone, 24%Pb amber crystal door handle.  
Polished brass base.*

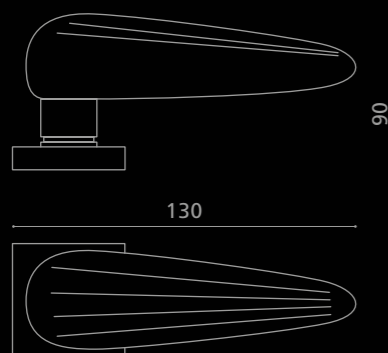

Fori chiave disponibili / Available key holes



**KIKKKT01F4OP2**  
Maniglia in cristallo trasparente. Montatura in ottone cromato.  
*Clear crystal door handle. Chrome plated brass base.*



**KIKKKS01F4OP2**  
Maniglia in cristallo satinato. Montatura in ottone cromato.  
*Mat crystal door handle. Chrome plated brass base.*

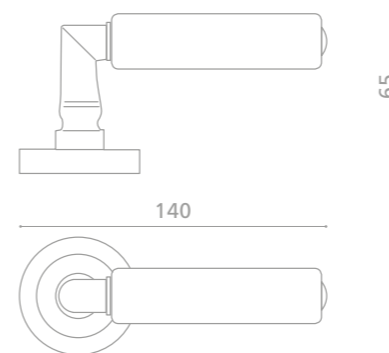

Fori chiave disponibili / Available key holes

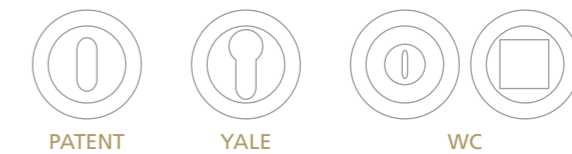

# GOLF

Cristallo  
DE' MEDICI®  
Pb 24%



## GOLFT01F4OP2

Maniglia in cristallo trasparente 24% Pb, molato a mano con mole a pietra.  
Montatura in ottone cromato.  
*Hand bevelled in stone, 24%Pb clear crystal door handle.  
Chrome plated brass base.*

# ELKA

Liscia

Cristallo  
DE' MEDICI®  
Pb 24%



## ELKALT01F4OP2

Maniglia in cristallo trasparente 24% Pb, molato a mano con mole a pietra.  
Montatura in ottone cromato.  
*Hand bevelled in stone, 24%Pb clear crystal door handle.  
Chrome plated brass base.*

**GOLFS01F4OP2**  
Maniglia in cristallo satinato 24% Pb, molato a mano con mole a pietra. Montatura in ottone cromato.  
*Hand bevelled in stone, 24%Pb mat crystal door handle.  
Chrome plated brass base.*

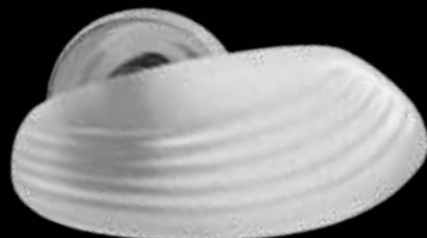

**GOLFT05F1OP2**  
Maniglia in cristallo ambra 24% Pb, molato a mano con mole a pietra. Montatura in ottone lucido.  
*Hand bevelled in stone, 24%Pb amber crystal door handle.  
Polished brass base.*



**ELKALS01F4OP2**  
Maniglia in cristallo satinato 24% Pb, molato a mano con mole a pietra. Montatura in ottone cromato.  
*Hand bevelled in stone, 24%Pb mat crystal door handle.  
Chrome plated brass base.*

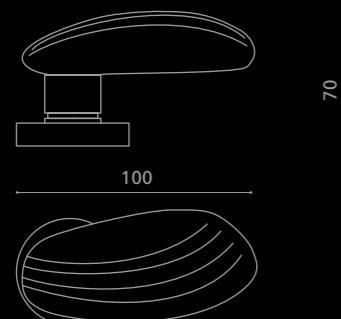

Fori chiave disponibili / Available key holes

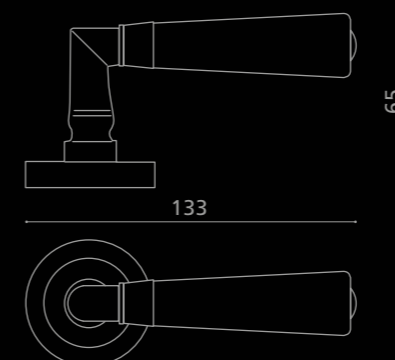

Fori chiave disponibili / Available key holes



# ELKA Rigata

Cristallo  
DE' MEDICI®  
Pb 24%



## ELKART01F4OP2

Maniglia in cristallo trasparente 24% Pb, molato a mano con mole a pietra.  
Montatura in ottone cromato.  
*Hand bevelled in stone, 24%Pb clear crystal door handle.  
Chrome plated brass base.*

# ELKA Torciglione

Cristallo  
DE' MEDICI®  
Pb 24%

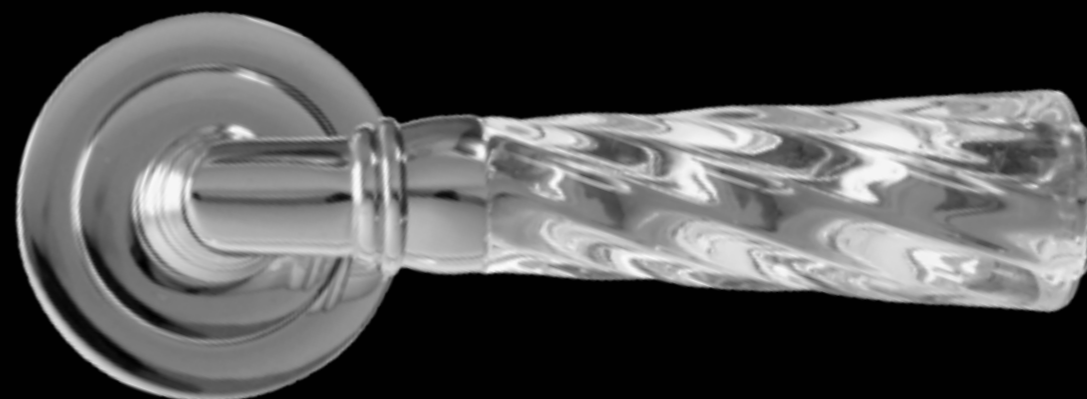

## ELKATT01F4OP2

Maniglia in cristallo trasparente 24% Pb, molato a mano con mole a pietra.  
Montatura in ottone cromato.  
*Hand bevelled in stone, 24%Pb clear crystal door handle.  
Chrome plated brass base.*

**ELKARS01F4OP2**  
Maniglia in cristallo satinato 24% Pb, molato a mano con mole a pietra. Montatura in ottone cromato.  
*Hand bevelled in stone, 24%Pb mat crystal door handle.  
Chrome plated brass base.*



**ELKATS01F4OP2**  
Maniglia in cristallo satinato 24% Pb, molato a mano con mole a pietra. Montatura in ottone cromato.  
*Hand bevelled in stone, 24%Pb mat crystal door handle.  
Chrome plated brass base.*



**ELKART05F1OP2**  
Maniglia in cristallo ambra 24% Pb, molato a mano con mole a pietra. Montatura in ottone lucido.  
*Hand bevelled in stone, 24%Pb amber crystal door handle.  
Polished brass base.*



**ELKATT05F1OP2**  
Maniglia in cristallo ambra 24% Pb, molato a mano con mole a pietra. Montatura in ottone lucido.  
*Hand bevelled in stone, 24%Pb amber crystal door handle.  
Polished brass base.*

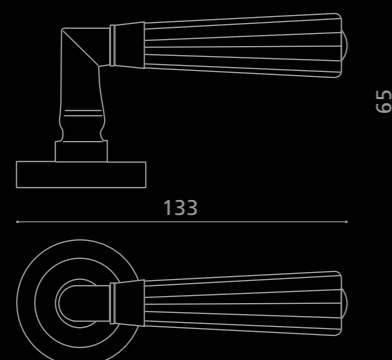

Fori chiave disponibili / Available key holes

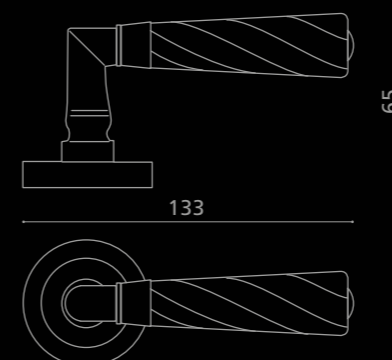

Fori chiave disponibili / Available key holes





# OVO Liscio

Cristallo  
**DE' MEDICI**  
Pb 24%



**OVOLS01F4OP2PT**

Pomolo da porta in cristallo satinato 24% Pb, molato a mano con mole a pietra.  
Montatura in ottone cromato con bocchetta patent.  
*Hand bevelled in stone, 24%Pb mat crystal door knob.  
Chrome plated brass base with patent key hole.*

**OVOLT01F4OP2**

Pomolo da porta in cristallo trasparente 24% Pb, molato a mano con mole a pietra.  
Montatura in ottone cromato.  
*Hand bevelled in stone, 24%Pb clear crystal door knob.  
Chrome plated brass base.*

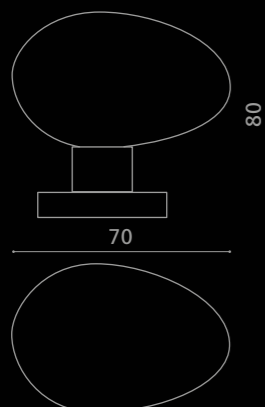

Fori chiave disponibili / Available key holes



# OVO Rigato

Cristallo  
**DE' MEDICI**  
Pb 24%



**OVORS01F1OP2PT**

Pomolo da porta in cristallo trasparente/satinato 24% Pb, molato a mano con mole a pietra.  
Montatura in ottone lucido con bocchetta patent.  
*Hand bevelled in stone, 24%Pb clear/mat crystal door knob.  
Polished brass base with patent key hole.*

**OVORT01F4OP2**

Pomolo da porta in cristallo trasparente 24% Pb, molato a mano con mole a pietra.  
Montatura in ottone cromato.  
*Hand bevelled in stone, 24%Pb clear crystal door knob.  
Chrome plated brass base.*

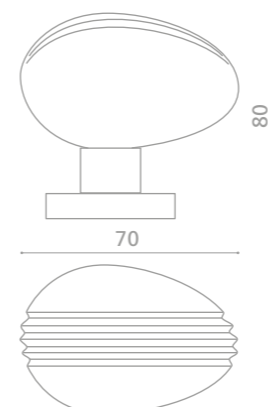

Fori chiave disponibili / Available key holes

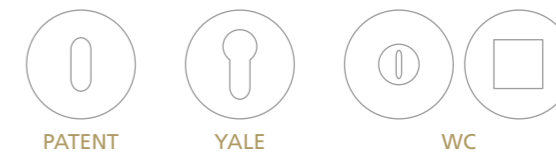

# GOCCIA Black/Gold

made with  
**MURANO**  
glass

*... preziosa ...*  
*... precious ...*

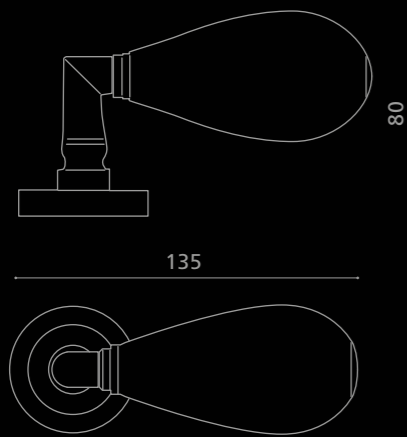

Fori chiave disponibili / Available key holes



PATENT



YALE



WC

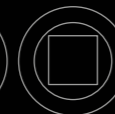

## GOCCIANF0F10P2PT

Maniglia in vetro soffiato di Murano opale nero / foglia oro.  
Montatura in ottone lucido con bocchetta patent.

Blown Murano glass door handle, opal black / gold leaf.  
Polished brass base with patent key hole.

# GOCCIA White/Gold

made with  
**MURANO**  
glass

*... fashion ...*  
*... fashion ...*

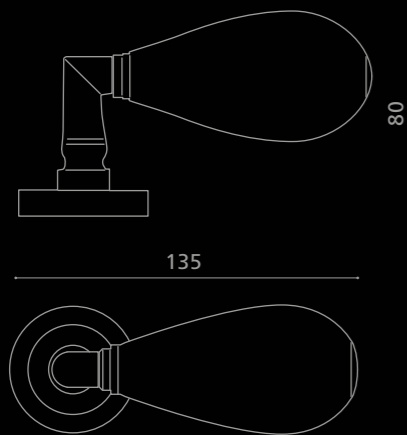

Fori chiave disponibili / Available key holes



PATENT



YALE



WC

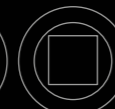

## GOCCIABFOF10P2PT

Maniglia in vetro soffiato di Murano opale bianco / foglia oro.  
Montatura in ottone lucido con bocchetta patent.

*Blown Murano glass door handle, opal white / gold leaf.  
Polished brass base with patent key hole.*

# GOCCIA Black/Silver

made with  
**MURANO**  
glass

*... affascinante ...*  
*... fascinating ...*

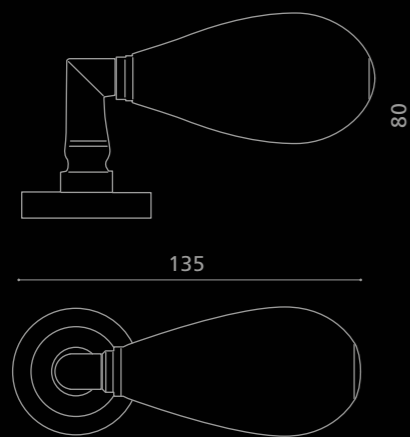
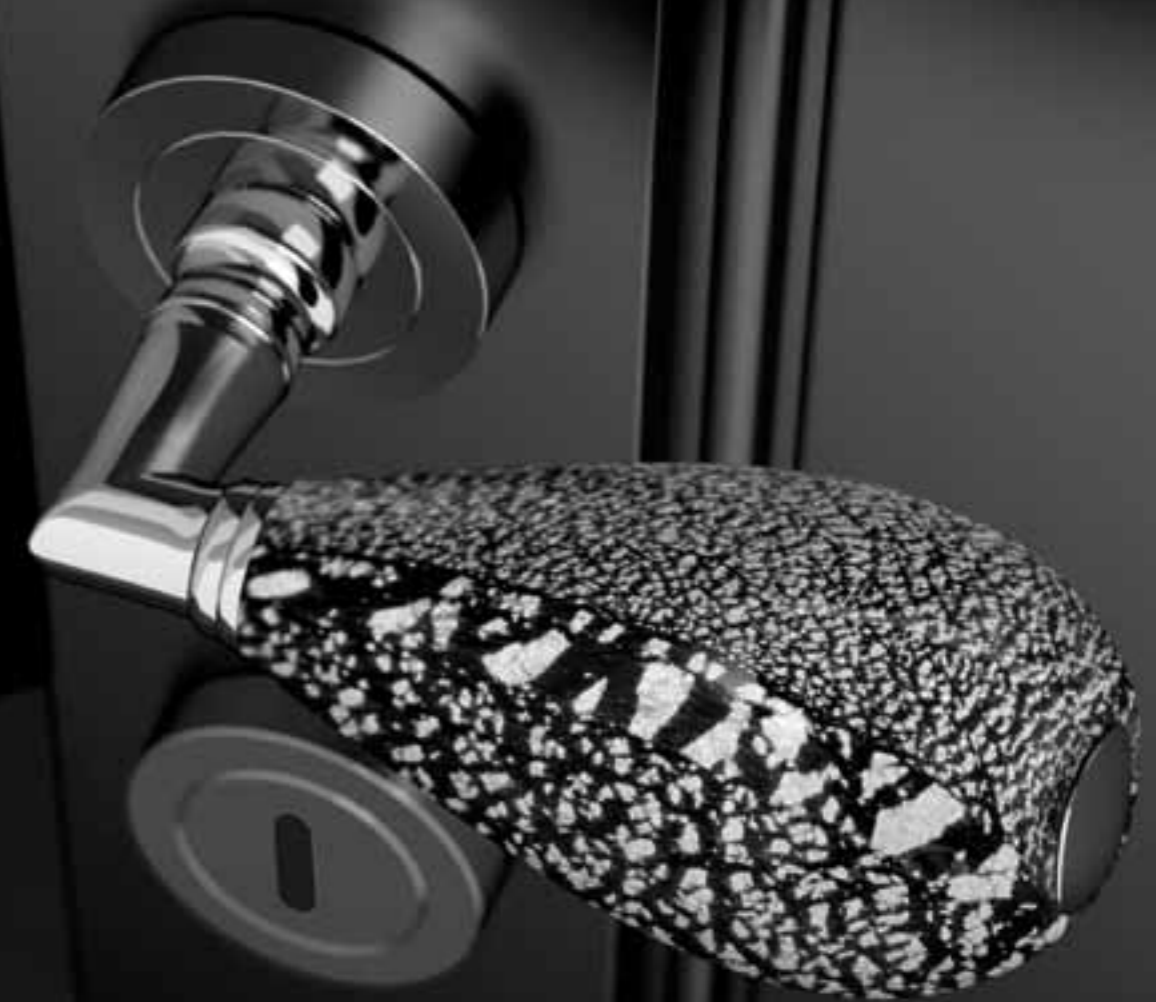

Fori chiave disponibili / Available key holes



## GOCCIANFAF40P2PT

Maniglia in vetro soffiato di Murano opale nero / foglia argento.  
Montatura in ottone cromato con bocchetta patent.

Blown Murano glass door handle, opal black / silver leaf.  
Chrome plated brass base with patent key hole.



# GOCCIA Black/Brown

made with  
**MURANO**  
glass

*... esclusiva ...*  
*... exclusive ...*

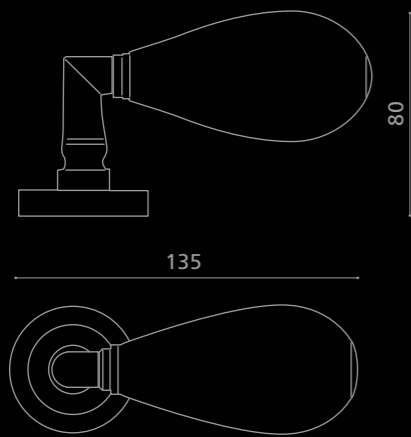

Fori chiave disponibili / Available key holes



PATENT



YALE



WC

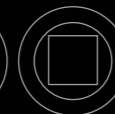

## GOCCIANAVF10P2PT

Maniglia in vetro soffiato di Murano opale nero / aventurina.  
Montatura in ottone lucido con bocchetta patent.

Blown Murano glass door handle, opal black / aventurine.  
Polished brass base with patent key hole.

# KERAMEIA Lux

Kerameia®



**KERAMD02BORF1OP2**

Maniglia in ceramica bianca con decorazione in oro (37 kt) realizzata a mano. Montatura in ottone lucido.  
White ceramic door handle with gold (37 kt) hand-painted decoration. Polished brass base.

# KIKKA Lux

Kerameia®



**KIKKABORF1OP2**

Maniglia in ceramica bianca con decorazione in oro (37 kt) realizzata a mano. Montatura in ottone lucido.  
White ceramic door handle with gold (37 kt) hand-painted decoration. Polished brass base.

**KERAMD02BPLF4OP2**

Maniglia in ceramica bianca con decorazione in platino realizzata a mano. Montatura in ottone cromato.  
Ceramic door handle with platinum hand-painted decoration. Chrome plated brass base.



**KIKKABPLF4OP2**

Maniglia in ceramica bianca con decorazione in platino realizzata a mano. Montatura in ottone cromato.  
Ceramic door handle with platinum hand-painted decoration. Chrome plated brass base.

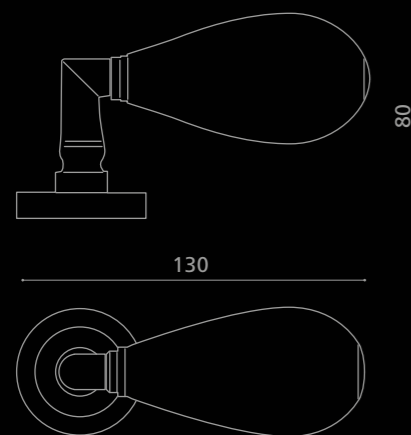

Fori chiave disponibili / Available key holes

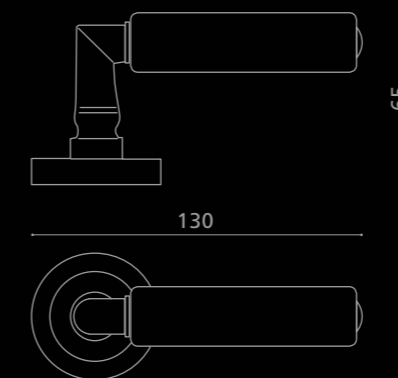

Fori chiave disponibili / Available key holes



# SFERA Home

made with  
**MURANO**  
glass



**SFERAHT35F4OP9PT**  
Pomolo per porta in vetro di Murano nero.  
Montatura in ottone cromato con bocchetta patent.  
*Black Murano glass door knob.  
Chrome plated brass base with patent key hole.*

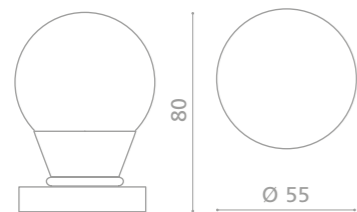

Fori chiave disponibili / Available key holes

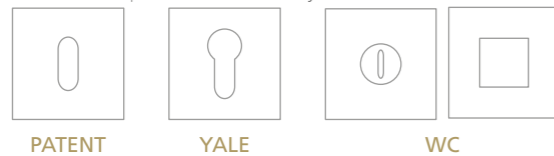

**SFERAHT01F4OP9PT**  
Pomolo per porta in vetro di Murano trasparente.  
Montatura in ottone cromato con bocchetta patent.  
*Clear Murano glass door knob.  
Chrome plated brass base with patent key hole.*

*... perfetta ...*  
*... perfect ...*

# GEO

Cristallo  
DE' MEDICI®  
Pb 24%



**GEO60T35F4OP9PT**

Pomolo per porta in cristallo nero, molato a mano con mole a pietra.  
Montatura in ottone cromato con bocchetta patent.  
*Hand bevelled in stone, black crystal door knob.  
Chrome plated brass base with patent key hole.*

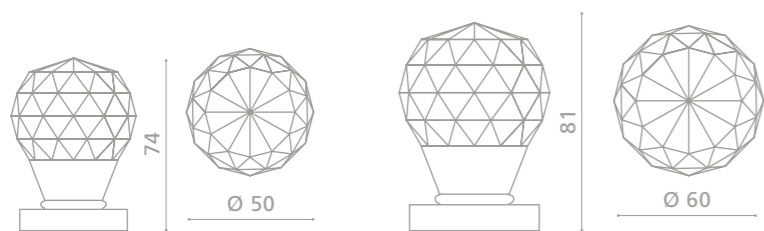

Fori chiave disponibili / Available key holes

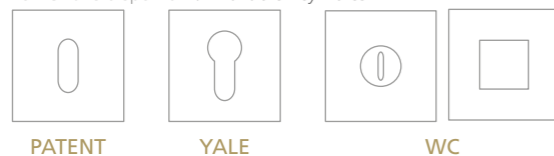

PATENT

YALE

WC



**GEO60T01F4OP9PT**

Pomolo per porta in cristallo trasparente,  
molato a mano con mole a pietra.  
Montatura in ottone cromato con bocchetta patent.  
*Hand bevelled in stone, clear crystal door knob.  
Chrome plated brass base with patent key hole.*

... luminosa ...

... brilliant ...



# MARGHERITA



## MARGS01F4OP2

Pomolo da porta in cristallo satinato 24% Pb, molato a mano con mole a pietra. Montatura in ottone cromato.  
*Hand bevelled in stone, 24%Pb mat crystal door knob. Chrome plated brass base.*

**MARGT01F4OP2**  
Pomolo da porta in cristallo trasparente 24% Pb, molato a mano con mole a pietra. Montatura in ottone cromato.  
*Hand bevelled in stone, 24%Pb clear crystal door knob. Chrome plated brass base.*

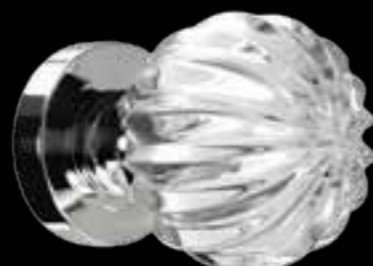

Fori chiave disponibili / Available key holes



# TORCIGLIONE



## TORCT01F4OP2

Pomolo da porta in cristallo trasparente 24% Pb, molato a mano con mole a pietra. Montatura in ottone cromato.  
*Hand bevelled in stone, 24%Pb clear crystal door knob. Chrome plated brass base.*

**TORCS01F4OP2**  
Pomolo da porta in cristallo satinato 24% Pb, molato a mano con mole a pietra. Montatura in ottone cromato.  
*Hand bevelled in stone, 24%Pb mat crystal door knob. Chrome plated brass base.*

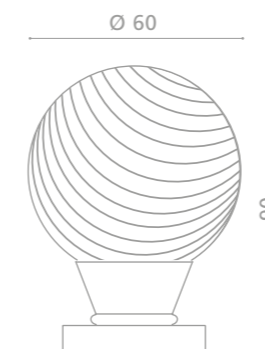

Fori chiave disponibili / Available key holes

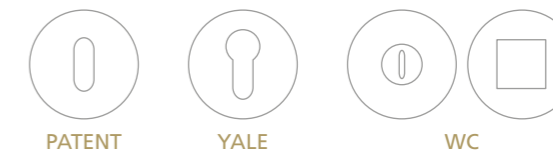

# DELUXE

Pull&Push

Cristallo  
DE' MEDICI<sup>®</sup>  
Pb 24%

*... importante ...*  
*... important ...*

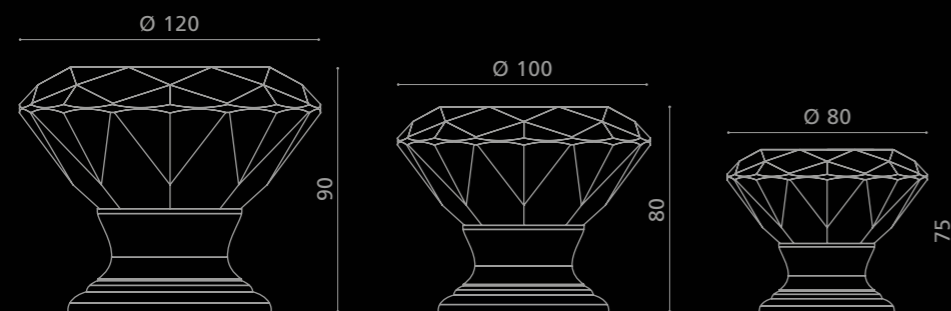

DELUXE120T01F1  
Pomolo pull&push in cristallo trasparente/sabbiato,  
molato a mano con mole a pietra. Montatura in ottone lucido.  
(bocchetta chiave disponibile su richiesta)  
*Hand bevelled in stone, clear/mat crystal pull&push knob.  
Polished brass base.  
(key rosette available on demand)*

# MARGHERITA

Pull&Push

Cristallo  
DE'MEDICI®  
Pb 24%



**MA100T01F4**  
Pomolo pull&push in cristallo trasparente 24% Pb, molato a mano con mole a pietra. Montatura in ottone cromato.  
*Hand bevelled in stone, 24% Pb clear crystal pull&push knob. Chrome plated brass base.*

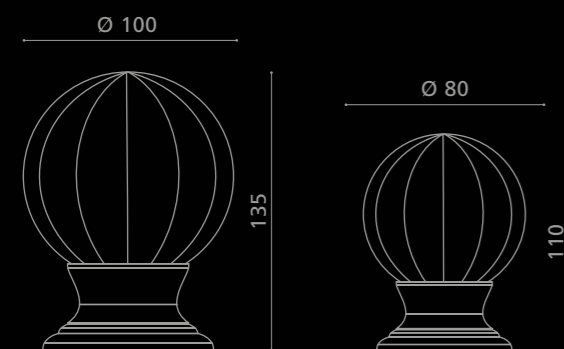

# STELLA

Pull&Push

Cristallo  
DE'MEDICI®  
Pb 24%



**ST100T01F4**  
Pomolo pull&push in cristallo trasparente 24% Pb, molato a mano con mole a pietra. Montatura in ottone cromato.  
*Hand bevelled in stone, 24% Pb clear crystal pull&push knob. Chrome plated brass base.*

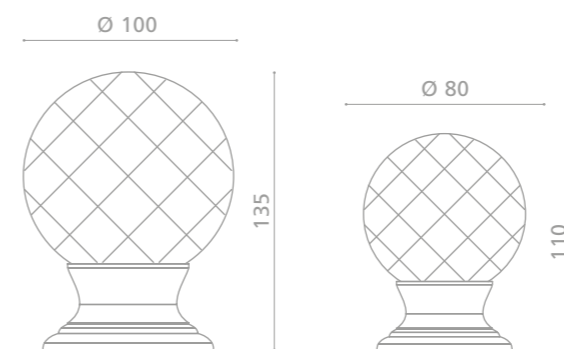



POMOLI *KNOBS*



# DIAMOND Pull

Cristallo  
**DE' MEDICI**  
Pb 24%

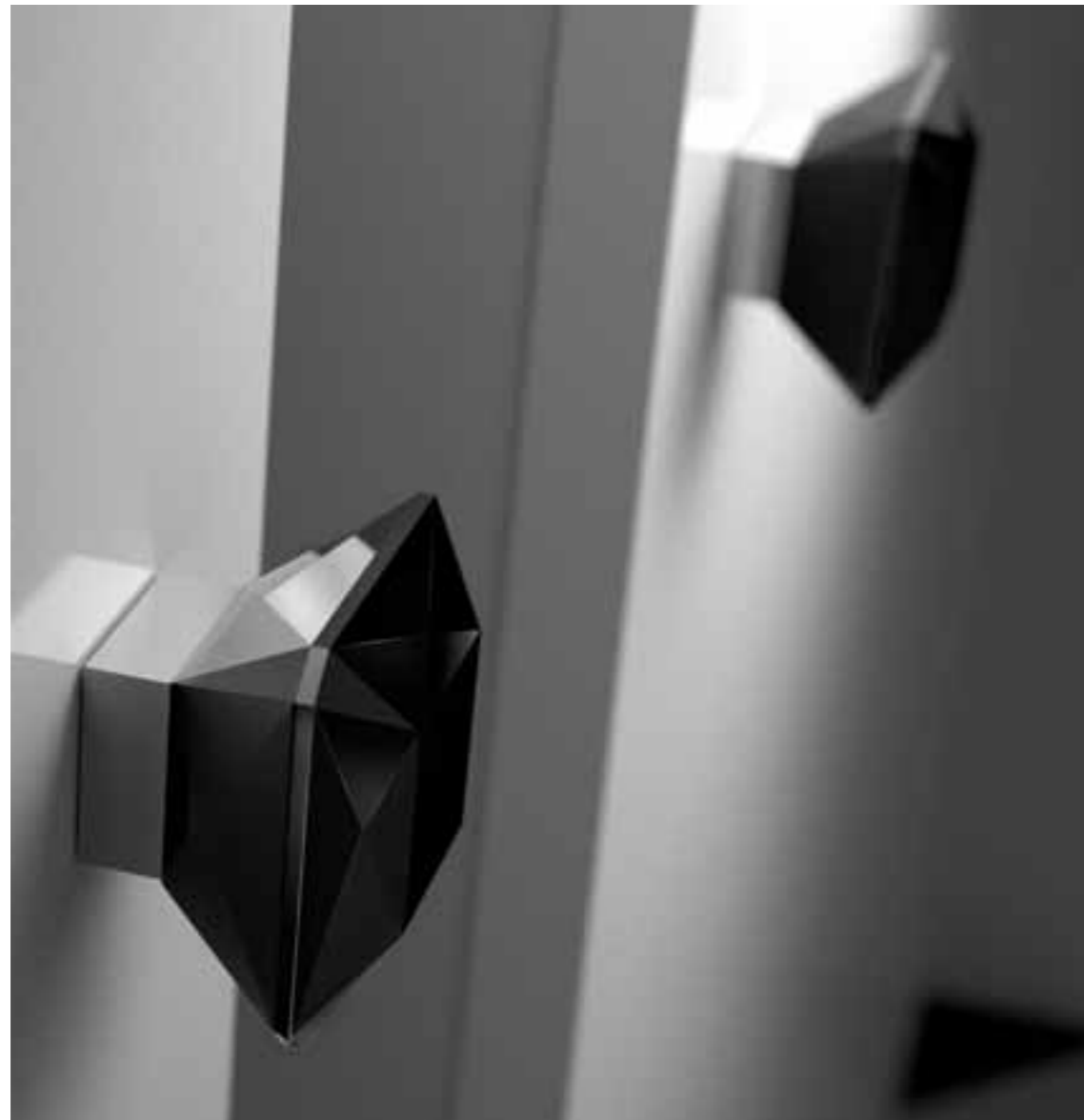

**DIAMPULL50T35F4**  
Pomolo per mobile in cristallo nero, molato a mano con mole a pietra. Montatura in ottone cromato.  
*Hand-bevelled in stone, black crystal furniture knob.  
Chrome plated brass base.*

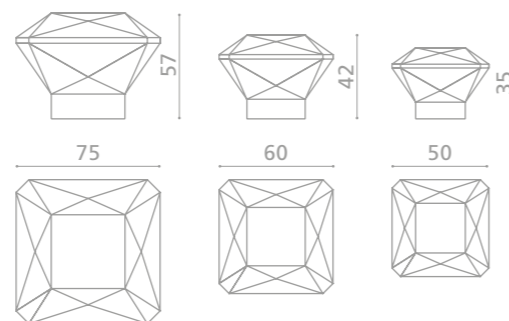

**DIAMPULL50T01F4**  
Pomolo per mobile in cristallo trasparente, molato a mano con mole a pietra. Montatura in ottone cromato.  
*Hand-bevelled in stone, clear crystal furniture knob.  
Chrome plated brass base.*

*... seducente ...*

*... attrattive ...*

# GEO Pull

Cristallo  
DE' MEDICI  
Pb 24%



**GEOPULL30T35F4**  
Pomolo per mobile in cristallo nero, molato a mano con mole a pietra. Montatura in ottone cromato.  
*Hand-bevelled in stone, black crystal furniture knob.*  
*Chrome plated brass base.*

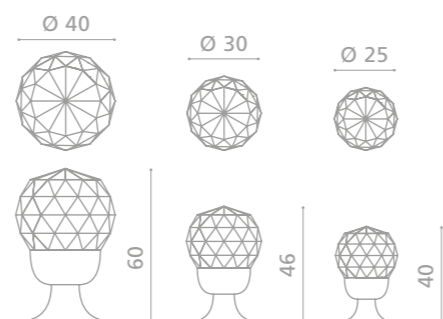

*...elegante ...*  
*... elegant ...*

**GEOPULL30T01F4**  
Pomolo per mobile in cristallo trasparente, molato a mano con mole a pietra. Montatura in ottone cromato.  
*Hand-bevelled in stone, clear crystal furniture knob.*  
*Chrome plated brass base.*

# DELUXE Knob

Cristallo  
**DE' MEDICI**<sup>®</sup>  
Pb 24%



## DELUXEK40T35F4

Pomolo per mobile in cristallo nero, molato a mano con mole a pietra. Montatura in ottone cromato.  
*Hand-bevelled in stone, black crystal furniture knob.*  
*Chrome plated brass base.*

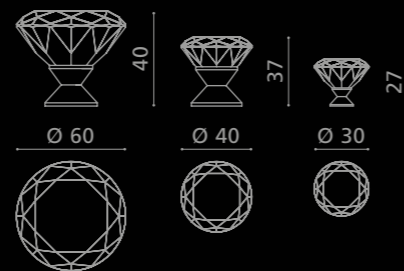

## DELUXEK40T01F4

Pomolo per mobile in cristallo trasparente, molato a mano con mole a pietra.  
*Montatura in ottone cromato.*  
*Hand-bevelled in stone, clear crystal furniture knob.*  
*Chrome plated brass base.*

... *gentile* ...

... *gentile* ...



# SFERA Pull

made with  
**MURANO**  
glass



## SFERAPULL30T35F4

Pomolo per mobile in vetro di Murano nero.  
Montatura in ottone cromato.  
Black Murano glass furniture knob.  
Chrome plated brass base.

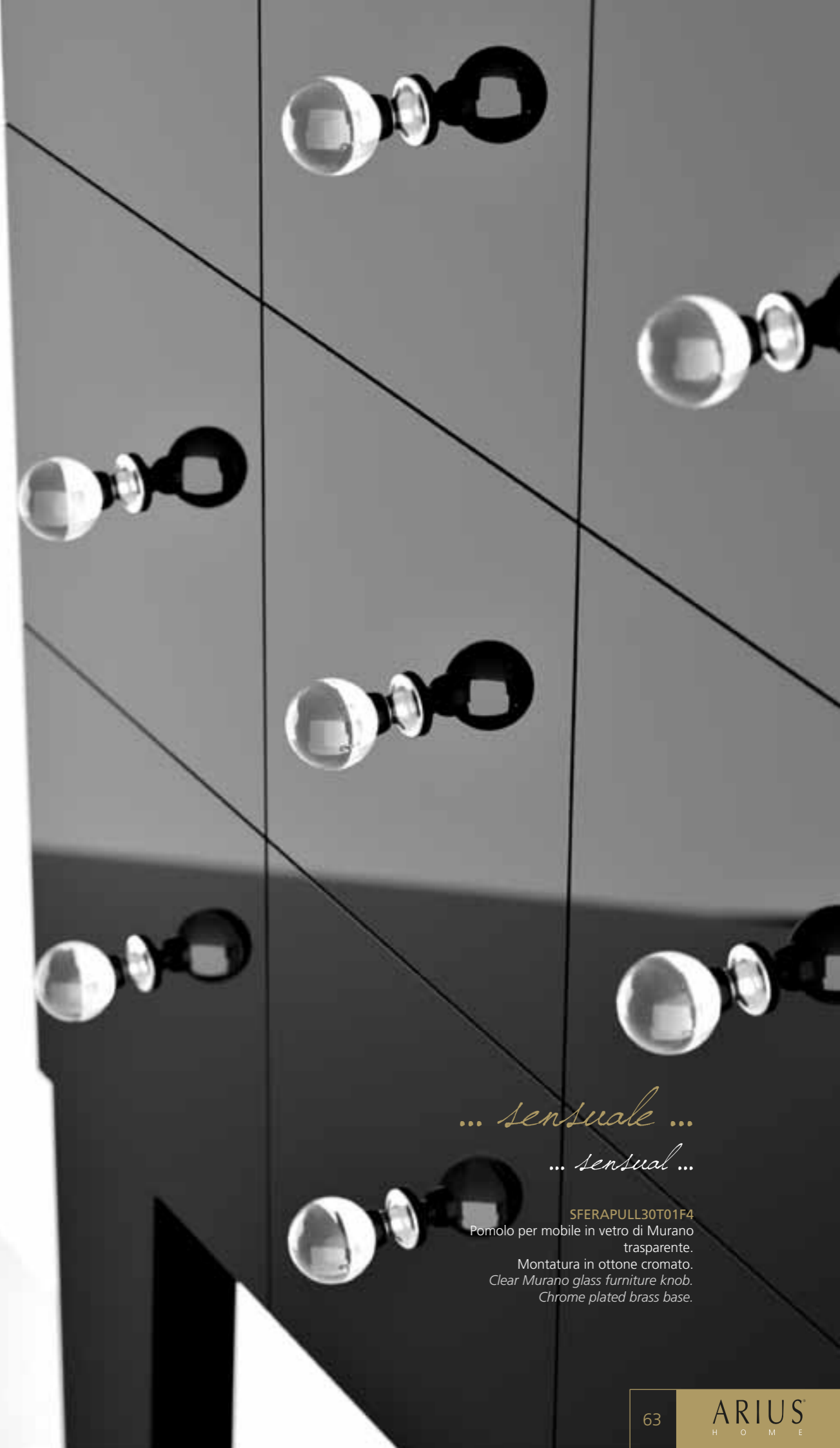
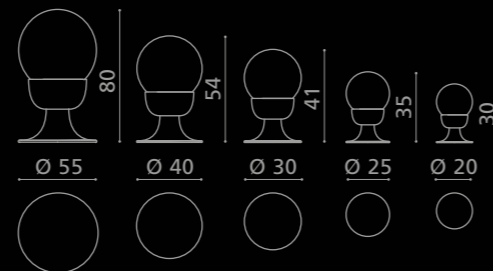

... sensuale ...

... sensual ...

## SFERAPULL30T01F4

Pomolo per mobile in vetro di Murano trasparente.  
Montatura in ottone cromato.  
Clear Murano glass furniture knob.  
Chrome plated brass base.

# PERLA<sub>LUX</sub>



## PERLALSMSWF4DM40

Pomolo per mobile in Madreperla smoke e cristalli swarovsky. Montatura in ottone cromato.  
*Smoke Mother of Pearl and swarovsky crystal furniture knob. Chrome plated brass base.*

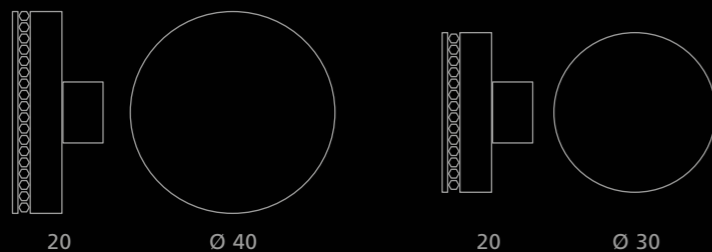

20

Ø 40

20

Ø 30



## PERLALMPSWF3DM40

Pomolo per mobile in Madreperla bianca e cristalli swarovsky. Montatura in ottone dorato.  
*White Mother of Pearl and swarovsky crystal furniture knob. Gold plated brass base.*

# PERLA Tondo



## PERLATSMF4DM40

Pomolo per mobile in Madreperla smoke. Montatura in ottone cromato.  
*Smoke Mother of Pearl furniture knob. Chrome plated brass base.*

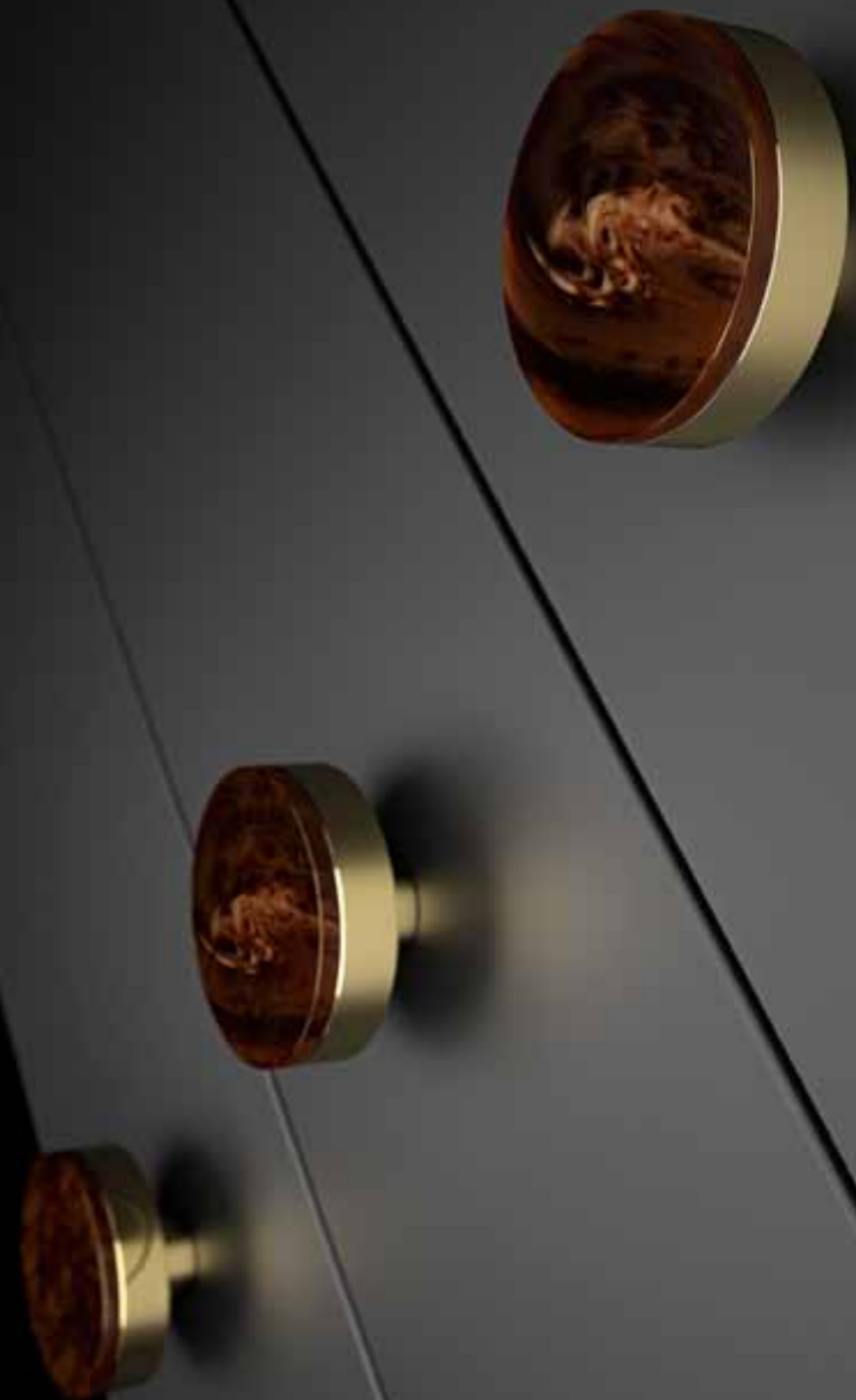
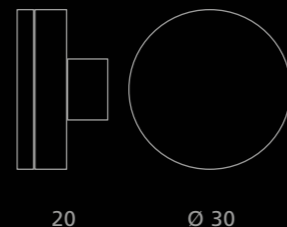
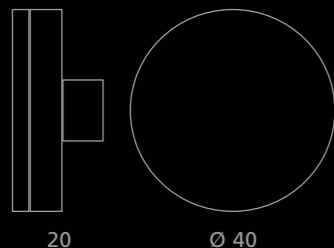

## PERLATCRF3DM40

Pomolo per mobile in Corno. Montatura in ottone dorato.  
*Horn furniture knob. Gold plated brass base.*

# PERLA Quadro

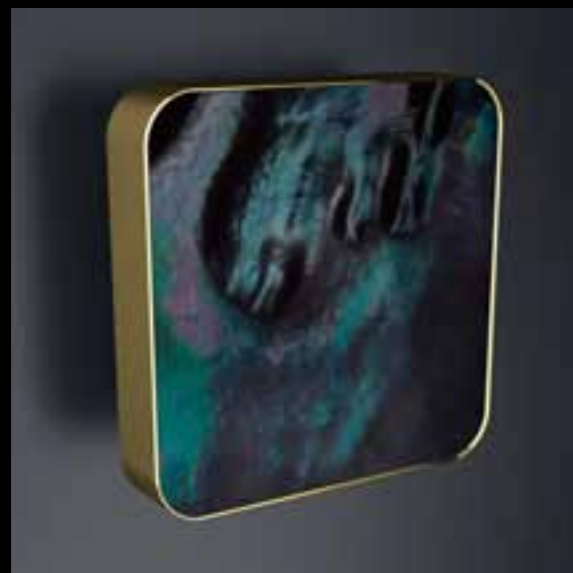

## PERLAQSMF340X40

Pomolo per mobile in Madreperla smoke. Montatura in ottone dorato.  
*Smoke Mother of Pearl furniture knob. Gold plated brass base.*

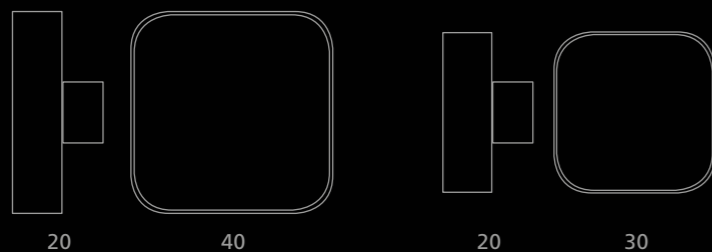

## PERLAQMPF440X40

Pomolo per mobile in Madreperla bianca.  
Montatura in ottone cromato.  
*White Mother of Pearl furniture knob.  
Chrome plated brass base.*

# SFERA P907



**P907S01F4DM44**  
satinato / ottone cromato  
mat white / chrome plated brass

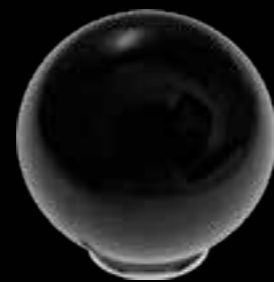

**P907T35F4DM44**  
nero / ottone cromato  
black / chrome plated brass

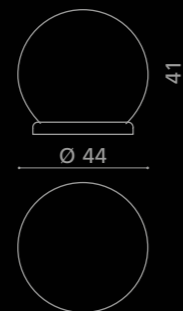

# MURANO Knob



**P905MARGF4DM40**  
trasparente/foglia argento  
base in ottone cromato  
clear/silver leaf  
chrome plated brass base  
Ø 40



**P905MOROF3DM40**  
trasparente/foglia oro  
base in ottone dorato  
clear/gold leaf  
gold plated brass base  
Ø 40

**P905MARGF4DM30**  
trasparente/foglia argento  
base in ottone cromato  
clear/silver leaf  
chrome plated brass base  
Ø 30



**P905MOROF3DM30**  
trasparente/foglia oro  
base in ottone dorato  
clear/gold leaf  
gold plated brass base  
Ø 30

**P905MARGF4DM25**  
trasparente/foglia argento  
base in ottone cromato  
clear/silver leaf  
chrome plated brass base  
Ø 25



**P905MOROF3DM25**  
trasparente/foglia oro  
base in ottone dorato  
clear/gold leaf  
gold plated brass base  
Ø 25

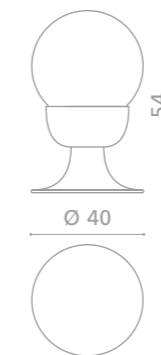



# DAISY



**P366G25F4DM40**  
trasparente / graniglia gialla - base in ottone cromato  
*clear / yellow graniglia - chrome plated brass base*



**P366G29F4DM40**  
trasparente / graniglia arancio - base in ottone cromato  
*clear / orange graniglia - chrome plated brass base*



**P366G23F4DM40**  
trasparente / graniglia verde - base in ottone cromato  
*clear / green graniglia - chrome plated brass base*



**P366G22F4DM40**  
trasparente / graniglia turchese - base in ottone cromato  
*clear / turquoise graniglia - chrome plated brass base*

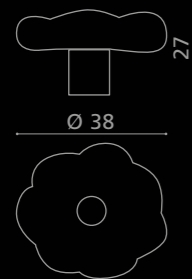

**P366T01F4DM40**  
trasparente - base in ottone cromato  
*clear - chrome plated brass base*



**P366S01F4DM40**  
satinato - base in ottone cromato  
*mat - chrome plated brass base*



**P366T24F4DM40**  
trasparente / oro - base in ottone cromato  
*clear / gold - chrome plated brass base*



**P366T25F4DM40**  
trasparente / platino - base in ottone cromato  
*clear / platinum - chrome plated brass base*

# POMOLI

Florence Glass  
ATELIER®

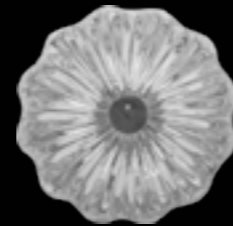

P331 Ø 25 - 30 - 40

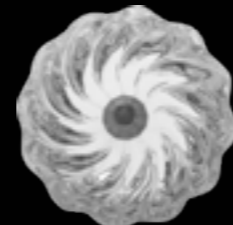

P341 Ø 25 - 30 - 40

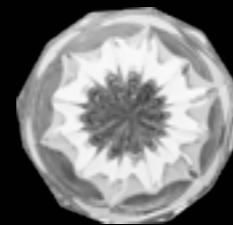

P901 Ø 30 - 40

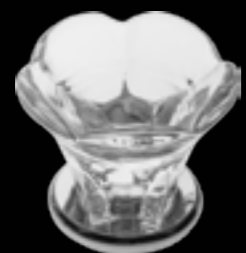

P365 Ø 25 - 30 - 40



P330 Ø 25 - 30 - 40



P333 Ø 25 - 30 - 40

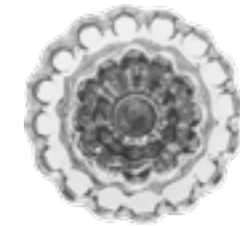

P909 Ø 25 - 35 - 45



P367 Ø 30 - H 47

Florence Glass  
ATELIER®

# POMOLI



P906 Ø 20



P405 Ø 25 - 30



P337 Ø 25 - 30 - 40

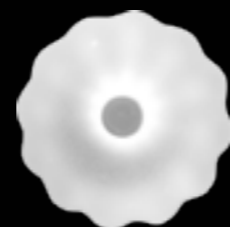

P332 Ø 25 - 30 - 40

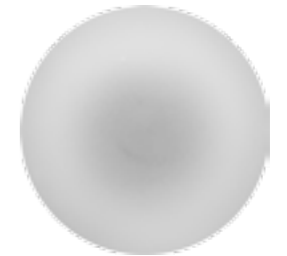

P351 Ø 40



P342 Ø 25 - 30 - 40



P336 Ø 25 - 30 - 40



P334 Ø 25 - 30 - 40

# FROZEN



**FROZENT36F4**  
Pomolo in vetro artistico trasparente madreperlato. Base in ottone cromato.  
*Clear glass furniture knob with mother of pearl shade. Chrome plated brass base.*



**FROZENT23F4**  
Pomolo in vetro artistico verde chiaro.  
Base in ottone cromato.  
*Pale green artistic glass furniture knob.  
Chrome plated brass base.*



**FROZENT20F4**  
Pomolo in vetro artistico acquamarina.  
Base in ottone cromato.  
*Marine artistic glass furniture knob.  
Chrome plated brass base.*



**FROZENT37F4**  
Pomolo in vetro artistico ambra.  
Base in ottone cromato.  
*Amber artistic glass furniture knob.  
Chrome plated brass base.*





**MANIGLIONI** *PULL HANDLES*  
**MANIGLIETTE** *FURNITURE HANDLES*  
**PORTABITI** *COAT HANGERS*  
**COPRINTERRUTTORI** *SWITCH COVERS*

# PROFILI



**PF40T01F1**  
Maniglione in cristallo trasparente. Montature in ottone lucido (L. 400 mm).  
*Clear crystal pull handle. Polished brass bases (L. 400 mm).*



**PF40S01F4**  
Maniglione in cristallo satinato. Montature in ottone cromato (L. 400 mm).  
*Mat crystal pull handle. Chrome plated brass bases (L. 400 mm).*

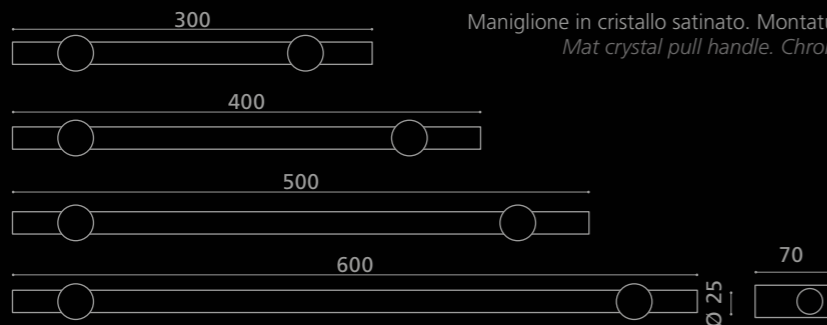

# TORCÉ



**TR60T01F4**  
Maniglione in cristallo trasparente 24% Pb. Montature in ottone cromato (L. 600 mm).  
*24% Pb clear crystal pull handle. Chrome plated brass bases (L. 600 mm).*



**TR60T01F1**  
Maniglione in cristallo trasparente 24% Pb. Montature in ottone lucido (L. 600 mm).  
*24% Pb clear crystal pull handle. Polished brass bases (L. 600 mm).*

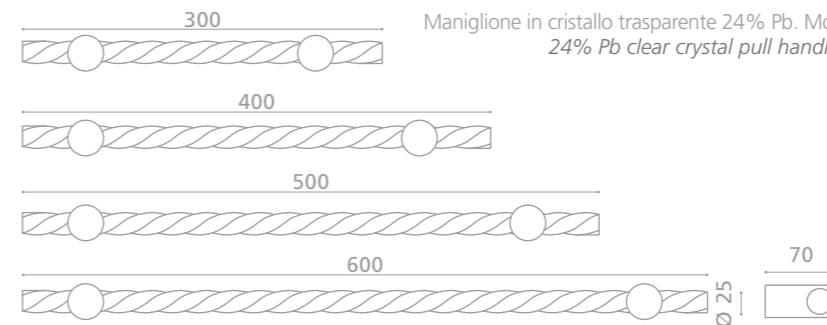

# M510

Cristallo  
DE' MEDICI®  
Pb 24%



**M510T01F4CF96**  
Maniglia in cristallo trasparente.  
Montature in ottone cromato (L. 130 mm).  
*Clear crystal furniture handle.  
Chrome plated brass bases (L. 130 mm).*

**M510S01F3CF96**  
Maniglia in cristallo satinato.  
Montature in ottone dorato (L. 130 mm).  
*Mat crystal furniture handle.  
Gold plated brass bases (L. 130 mm).*

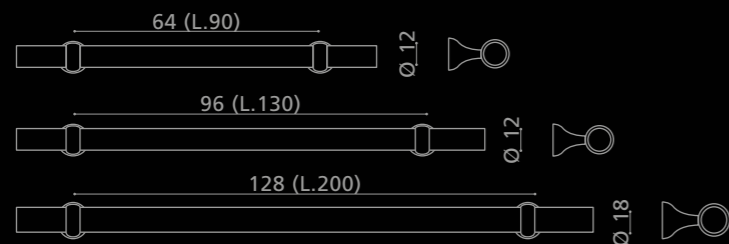

# FOGLIA

The Luxury®  
LEAF



**FOGLIAFACF96**  
Maniglia in metallo con foglia argento 3d (L. 150 mm).  
*Metal furniture handle with silver leaf 3d (L. 150 mm)*

**FOGLIAFOCF96**  
Maniglia in metallo con foglia oro 3d (L. 150 mm).  
*Metal furniture handle with gold leaf 3d (L. 150 mm).*



**FOGLIAFRCF96**  
Maniglia in metallo con foglia rame 3d (L. 150 mm).  
*Metal furniture handle with copper leaf 3d (L. 150 mm).*

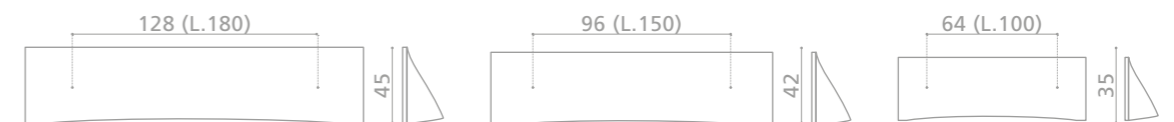

# TORCÉ Coat



**P701S01F4**

Portabito in vetro satinato lavorato a mano. Montatura in ottone cromato.  
*Mat hand made glass coat hanger. Chrome plated brass base.*

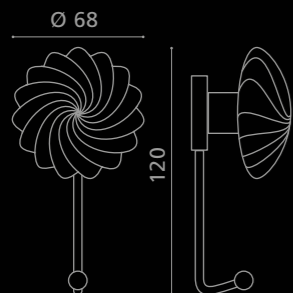

**P701T01F4**

Portabito in vetro trasparente lavorato a mano. Montatura in ottone cromato.  
*Clear hand made glass coat hanger. Chrome plated brass base.*



# SFERA Coat GEO Coat



**P707T35F4**

Portabito in vetro nero lavorato a mano. Montatura in ottone cromato.  
*Black hand made glass coat hanger. Chrome plated brass base.*

**P707S01F4**

Portabito in vetro satinato lavorato a mano. Montatura in ottone cromato.  
*Mat hand made glass coat hanger. Chrome plated brass base.*

**P707S18F4**

Portabito in vetro blu satinato lavorato a mano. Montatura in ottone cromato.  
*Mat blue hand made glass coat hanger. Chrome plated brass base.*

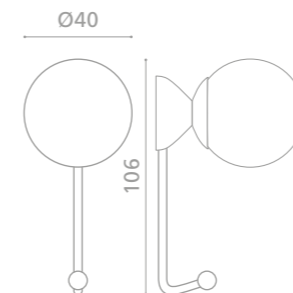

**P708T01F4**

Portabito in cristallo trasparente molato a mano. Montatura in ottone cromato.  
*Clear hand made crystal coat hanger. Chrome plated brass base.*

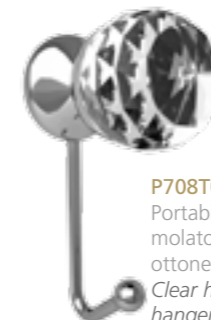

**P708T35F4**

Portabito in cristallo nero molato a mano. Montatura in ottone cromato.  
*Black hand made crystal coat hanger. Chrome plated brass base.*

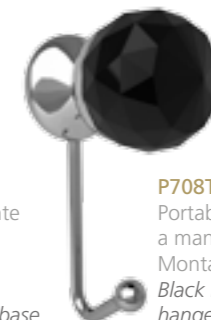



**ENEAT01F43F**

Coprinterruttore in cristallo trasparente 24% Pb.  
Placca in ottone cromato - 3 fori.  
*Clear 24% Pb crystal switch cover plate.  
Chrome plated brass plate - 3 holes.*



**ENEAF4F42F**

Coprinterruttore in cristallo 24% Pb con foglia argento 3d.  
Placca in ottone cromato - 2 fori.  
*Silver leaf 3d on 24% Pb crystal switch cover plate.  
Chrome plated brass plate - 2 holes.*

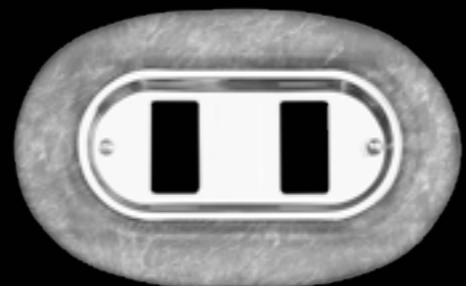

**ENEAF0F41F**

Coprinterruttore in cristallo 24% Pb con foglia oro 3d.  
Placca in ottone cromato - 1 foro.  
*Gold leaf 3d on 24% Pb crystal switch cover plate.  
Chrome plated brass plate - 1 hole.*

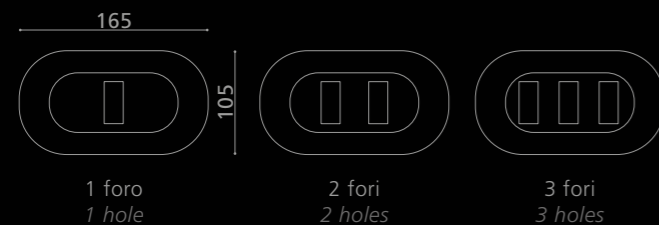

Disponibile per serie Magic della B-Ticino.  
*Available for B-Ticino Magic series.*

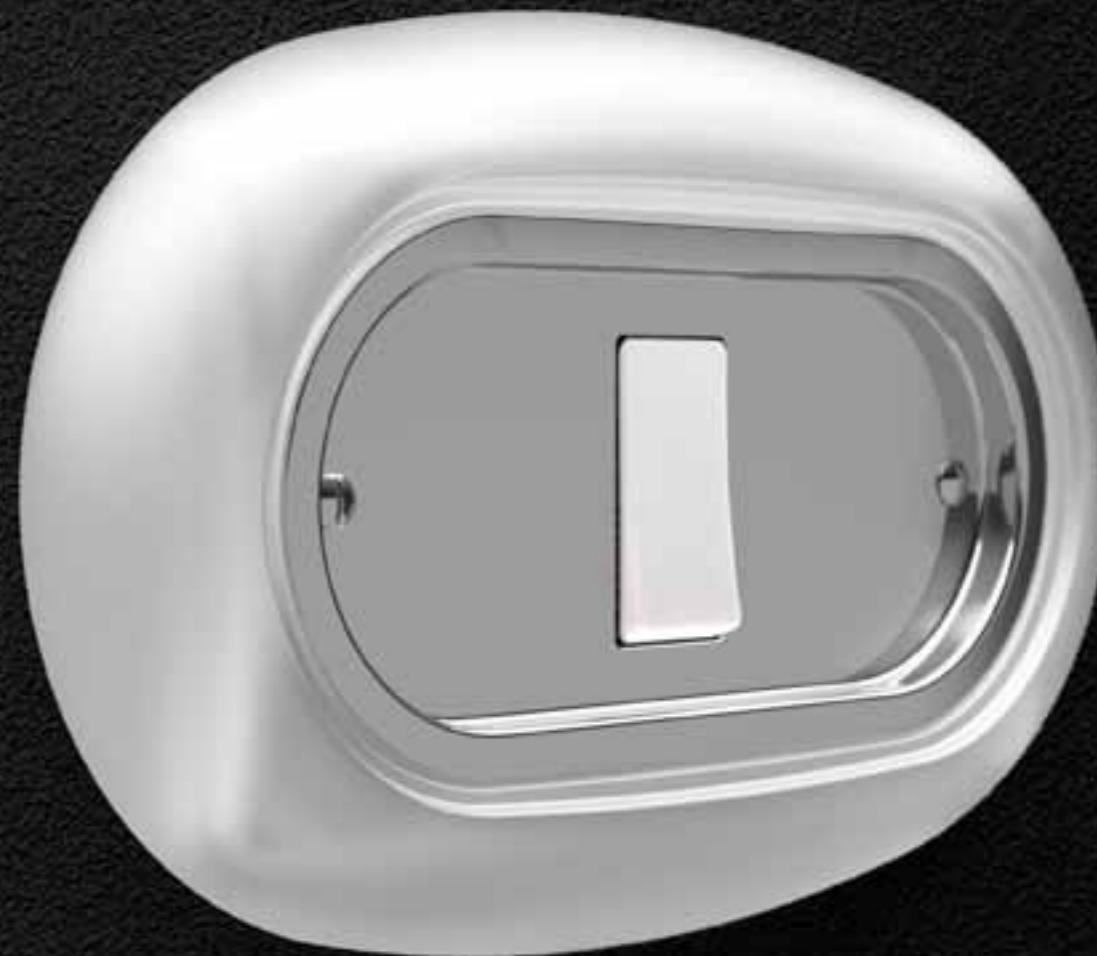

**ENEAS01F41F**

Coprinterruttore in cristallo satinato 24% Pb. Placca in ottone cromato - 1 foro.  
*Mat 24% Pb crystal switch cover plate. Chrome plated brass plate - 1 hole.*



**SCHEDE** *DATA SHEET*











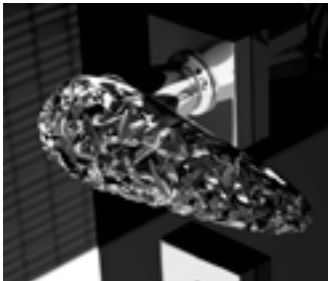































# MANIGLIE E POMOLI PER PORTA

# DOOR HANDLES / DOOR KNOBS

ESEMPIO DI ORDINE ORDER EXAMPLE

nome name	col. cristallo crystal colour	finit. ottone brass finish	foro chiave key hole
<input type="text"/>	<input type="text"/>	<input type="text"/>	<input type="text"/>

L'ordine si intende a coppia - The order is considered for the pair

Nome Name	Colore cristallo Crystal colour	Finitura ottone Brass finish	Foro chiave Key hole
 <p><b>ICE</b> Cristallo DE MEDICI Pb 24%</p>	 <b>T01</b> trasparente clear	 <b>F4</b> cromo chrome  <b>F1</b> ottone lucido polished brass  <b>F8</b> cromo spazzolato brushed chrome	 <b>PATENT</b> 52x52 mm  <b>YALE</b> 52x52 mm  <b>WC</b> 52x52 mm
 <p><b>LUXOR</b> Cristallo DE MEDICI Pb 24%</p>	 <b>T01</b> trasparente clear	 <b>F4</b> cromo chrome  <b>F1</b> ottone lucido polished brass  <b>F8</b> cromo spazzolato brushed chrome	 <b>PATENT</b> 52x52 mm  <b>YALE</b> 52x52 mm  <b>WC</b> 52x52 mm
 <p><b>DIAMOND Q</b> Cristallo DE MEDICI Pb 24%</p>	 <b>T01</b> trasparente clear  <b>T35</b> opale nero opal black	 <b>F4</b> cromo chrome  <b>F1</b> ottone lucido polished brass  <b>F8</b> cromo spazzolato brushed chrome	 <b>PATENT</b> 52x52 mm  <b>YALE</b> 52x52 mm  <b>WC</b> 52x52 mm
 <p><b>ROUND Home</b> Cristallo DE MEDICI Pb 24%</p>	 <b>TS01</b> trasparente/sabbiato clear/mat  <b>TS33</b> trasparente/moka clear/moka  <b>TS30</b> trasparente/nero clear/black	 <b>F4</b> cromo chrome  <b>F1</b> ottone lucido polished brass  <b>F8</b> cromo spazzolato brushed chrome	 <b>PATENT</b> 52x52 mm  <b>YALE</b> 52x52 mm  <b>WC</b> 52x52 mm
 <p><b>KYMI Home</b> Cristallo DE MEDICI Pb 24%</p>	 <b>T01</b> trasparente clear	 <b>F4</b> cromo chrome  <b>F1</b> ottone lucido polished brass  <b>F8</b> cromo spazzolato brushed chrome	 <b>PATENT</b> 52x52 mm  <b>YALE</b> 52x52 mm  <b>WC</b> 52x52 mm

















































# MANIGLIE E POMOLI PER PORTA

# DOOR HANDLES / DOOR KNOBS

ESEMPIO DI ORDINE ORDER EXAMPLE

nome name	col. cristallo crystal colour	finit. ottone brass finish	foro chiave key hole
<input type="text"/>	<input type="text"/>	<input type="text"/>	<input type="text"/>

L'ordine si intende a coppia - The order is considered for the pair

Nome Name	Colore cristallo Crystal colour	Finitura ottone Brass finish	Foro chiave Key hole
 <p><b>KOS Home</b></p> <p>Cristallo DE MEDICI Pb 24%</p>	 <p>T01 trasparente clear</p>	 <p>F4 cromo chrome</p>  <p>F1 ottone lucido polished brass</p>  <p>F8 cromo spazzolato brushed chrome</p>	 <p>PATENT 52x52 mm</p>  <p>YALE 52x52 mm</p>  <p>WC 52x52 mm</p>
 <p><b>KEA Home</b></p> <p>Cristallo DE MEDICI Pb 24%</p>	 <p>T01 trasparente clear</p>  <p>S01 satinato mat white</p>  <p>T05 ambra amber</p>	 <p>F4 cromo chrome</p>  <p>F1 ottone lucido polished brass</p>  <p>F8 cromo spazzolato brushed chrome</p>	 <p>PATENT 52x52 mm</p>  <p>YALE 52x52 mm</p>  <p>WC 52x52 mm</p>
 <p><b>ARKADIA Home</b></p> <p>Cristallo DE MEDICI Pb 24%</p>	 <p>T01 trasparente clear</p>  <p>T05 ambra amber</p>	 <p>F4 cromo chrome</p>  <p>F1 ottone lucido polished brass</p>  <p>F8 cromo spazzolato brushed chrome</p>	 <p>PATENT 50x50 mm</p>  <p>YALE 50x50 mm</p>  <p>WC 50x50 mm</p>
 <p><b>CUBE</b></p> <p>Cristallo DE MEDICI Pb 24%</p>	 <p>T01 trasparente clear</p>  <p>T35 opale nero opal black</p>  <p>T36 opale bianco opal white</p>	 <p>F4 cromo chrome</p>  <p>F1 ottone lucido polished brass</p>  <p>F8 cromo spazzolato brushed chrome</p>	 <p>PATENT 50x50 mm</p>  <p>YALE 50x50 mm</p>  <p>WC 50x50 mm</p>
 <p><b>WIND</b></p> <p>Cristallo DE MEDICI Pb 24%</p>	 <p>T01 trasparente clear</p>  <p>S01 satinato mat white</p>  <p>T05 ambra amber</p>	 <p>F4 cromo chrome</p>  <p>F1 ottone lucido polished brass</p>  <p>F8 cromo spazzolato brushed chrome</p>	 <p>PATENT Ø 52 mm</p>  <p>YALE Ø 52 mm</p>  <p>WC Ø 52 mm</p>































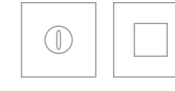















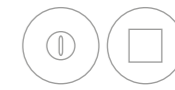

# MANIGLIE E POMOLI PER PORTA

# DOOR HANDLES / DOOR KNOBS

ESEMPIO DI ORDINE ORDER EXAMPLE

nome name	col. cristallo crystal colour	finit. ottone brass finish	foro chiave key hole
<input type="text"/>	<input type="text"/>	<input type="text"/>	<input type="text"/>

L'ordine si intende a coppia - The order is considered for the pair

Nome Name	Colore cristallo Crystal colour	Finitura ottone Brass finish	Foro chiave Key hole
 <p><b>KIARA</b></p> <p>Cristallo DE MEDICI Pb 24%</p>	 T01 trasparente clear  S01 satinato mat white  T05 ambra amber	 F4 cromo chrome  F1 ottone lucido polished brass  F8 cromo spazzolato brushed chrome	 PATENT Ø 52 mm  YALE Ø 52 mm  WC Ø 52 mm
 <p><b>OKA Home</b></p> <p>Cristallo DE MEDICI Pb 24%</p>	 T01 trasparente clear  S01 satinato mat white  T05 ambra amber	 F4 cromo chrome  F1 ottone lucido polished brass  F8 cromo spazzolato brushed chrome	 PATENT 52x52 mm  YALE 52x52 mm  WC 52x52 mm
 <p><b>KIKKA Krystal</b></p> <p>Cristallo DE MEDICI Pb 24%</p>	 T01 trasparente clear  S01 satinato mat white	 F4 cromo chrome  F1 ottone lucido polished brass  F8 cromo spazzolato brushed chrome	 PATENT Ø 50 mm  YALE Ø 50 mm  WC Ø 50 mm
 <p><b>GOLF</b></p> <p>Cristallo DE MEDICI Pb 24%</p>	 T01 trasparente clear  S01 satinato mat white  T05 ambra amber	 F4 cromo chrome  F1 ottone lucido polished brass  F8 cromo spazzolato brushed chrome	 PATENT Ø 52 mm  YALE Ø 52 mm  WC Ø 52 mm
 <p><b>ELKA Liscia</b></p> <p>Cristallo DE MEDICI Pb 24%</p>	 T01 trasparente clear  S01 satinato mat white	 F4 cromo chrome  F1 ottone lucido polished brass  F8 cromo spazzolato brushed chrome	 PATENT Ø 50 mm  YALE Ø 50 mm  WC Ø 50 mm



















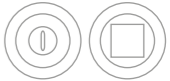

























# MANIGLIE E POMOLI PER PORTA

# DOOR HANDLES / DOOR KNOBS

ESEMPIO DI ORDINE ORDER EXAMPLE

nome name	col. cristallo crystal colour	finit. ottone brass finish	foro chiave key hole
<input type="text"/>	<input type="text"/>	<input type="text"/>	<input type="text"/>

L'ordine si intende a coppia - The order is considered for the pair

Nome Name	Colore cristallo Crystal colour	Finitura ottone Brass finish	Foro chiave Key hole
 <p><b>ELKA Rigata</b> Cristallo DE MEDICI Pb 24%</p>	 T01 trasparente clear  S01 satinato mat white  T05 ambra amber	 F4 cromo chrome  F1 ottone lucido polished brass  F8 cromo spazzolato brushed chrome	 PATENT Ø 50 mm  YALE Ø 50 mm  WC Ø 50 mm
 <p><b>ELKA Torciglione</b> Cristallo DE MEDICI Pb 24%</p>	 T01 trasparente clear  S01 satinato mat white  T05 ambra amber	 F4 cromo chrome  F1 ottone lucido polished brass  F8 cromo spazzolato brushed chrome	 PATENT Ø 50 mm  YALE Ø 50 mm  WC Ø 50 mm
 <p><b>OVO Liscio</b> Cristallo DE MEDICI Pb 24%</p>	 T01 trasparente clear  S01 satinato mat white	 F4 cromo chrome  F1 ottone lucido polished brass  F8 cromo spazzolato brushed chrome	 PATENT Ø 52 mm  YALE Ø 52 mm  WC Ø 52 mm
 <p><b>OVO Rigato</b> Cristallo DE MEDICI Pb 24%</p>	 T01 trasparente clear  S01 satinato mat white	 F4 cromo chrome  F1 ottone lucido polished brass  F8 cromo spazzolato brushed chrome	 PATENT Ø 52 mm  YALE Ø 52 mm  WC Ø 52 mm
 <p><b>GOCCIA Black/Gold</b> made with MURANO glass</p>	 NFO nero/foglia oro black/gold leaf	 F4 cromo chrome  F1 ottone lucido polished brass  F8 cromo spazzolato brushed chrome	 PATENT Ø 50 mm  YALE Ø 50 mm  WC Ø 50 mm











































# MANIGLIE E POMOLI PER PORTA

# DOOR HANDLES / DOOR KNOBS

ESEMPIO DI ORDINE ORDER EXAMPLE

nome name	col. cristallo crystal colour	finit. ottone brass finish	foro chiave key hole
<input type="text"/>	<input type="text"/>	<input type="text"/>	<input type="text"/>

L'ordine si intende a coppia - The order is considered for the pair

Nome Name	Colore cristallo Crystal colour	Finitura ottone Brass finish	Foro chiave Key hole
 <p><b>GOCCIA</b> White/Gold</p> <p>made with <b>MURANO</b> glass</p>	 <p><b>BFO</b> bianco/foglia oro white/gold leaf</p>	 <b>F4</b> cromo chrome  <b>F1</b> ottone lucido polished brass  <b>F8</b> cromo spazzolato brushed chrome	 <b>PATENT</b> Ø 50 mm  <b>YALE</b> Ø 50 mm  <b>WC</b> Ø 50 mm
 <p><b>GOCCIA</b> Black/Silver</p> <p>made with <b>MURANO</b> glass</p>	 <p><b>NFA</b> nero/foglia argento black/silver leaf</p>	 <b>F4</b> cromo chrome  <b>F1</b> ottone lucido polished brass  <b>F8</b> cromo spazzolato brushed chrome	 <b>PATENT</b> Ø 50 mm  <b>YALE</b> Ø 50 mm  <b>WC</b> Ø 50 mm
 <p><b>GOCCIA</b> Black/Brown</p> <p>made with <b>MURANO</b> glass</p>	 <p><b>NAV</b> nero/avventurina black/aventurine</p>	 <b>F4</b> cromo chrome  <b>F1</b> ottone lucido polished brass  <b>F8</b> cromo spazzolato brushed chrome	 <b>PATENT</b> Ø 50 mm  <b>YALE</b> Ø 50 mm  <b>WC</b> Ø 50 mm
 <p><b>KERAMEIA</b> Lux</p> <p><b>Kerameia</b></p>	 <b>D02BOR</b> bianco/oro white/gold  <b>D02BPL</b> bianco/platino white/platinum	 <b>F4</b> cromo chrome  <b>F1</b> ottone lucido polished brass  <b>F8</b> cromo spazzolato brushed chrome	 <b>PATENT</b> Ø 50 mm  <b>YALE</b> Ø 50 mm  <b>WC</b> Ø 50 mm
 <p><b>KIKKA</b> Lux</p> <p><b>Kerameia</b></p>	 <b>BOR</b> bianco/oro white/gold  <b>BPL</b> bianco/platino white/platinum	 <b>F4</b> cromo chrome  <b>F1</b> ottone lucido polished brass  <b>F8</b> cromo spazzolato brushed chrome	 <b>PATENT</b> Ø 50 mm  <b>YALE</b> Ø 50 mm  <b>WC</b> Ø 50 mm



















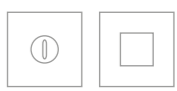









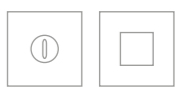



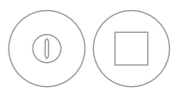

# MANIGLIE E POMOLI PER PORTA

# DOOR HANDLES / DOOR KNOBS

ESEMPIO DI ORDINE ORDER EXAMPLE

nome name    col. cristallo crystal colour    finit. ottone brass finish    foro chiave key hole

L'ordine si intende a coppia - The order is considered for the pair

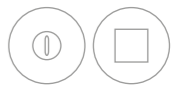
Nome Name	Colore cristallo Crystal colour	Finitura ottone Brass finish	Foro chiave Key hole
 <p><b>SFERA Home</b> made with <b>MURANO</b> glass</p>	 T01 trasparente clear  T35 opale nero opal black	 F4 cromo chrome  F1 ottone lucido polished brass  F8 cromo spazzolato brushed chrome	 PATENT 52x52 mm  YALE 52x52 mm  WC 52x52 mm
 <p><b>GEO</b> Cristallo <b>DE MEDICI</b> Pb 24%</p>	 T01 trasparente clear  T35 opale nero opal black  Ø 50  Ø 60	 F4 cromo chrome  F1 ottone lucido polished brass  F8 cromo spazzolato brushed chrome	 PATENT 52x52 mm  YALE 52x52 mm  WC 52x52 mm
 <p><b>MARGHERITA</b> Cristallo <b>DE MEDICI</b> Pb 24%</p>	 T01 trasparente clear  S01 satinato mat white	 F4 cromo chrome  F1 ottone lucido polished brass  F8 cromo spazzolato brushed chrome	 PATENT Ø 52 mm  YALE Ø 52 mm  WC Ø 52 mm
 <p><b>TORCIGLIONE</b> Cristallo <b>DE MEDICI</b> Pb 24%</p>	 T01 trasparente clear  S01 satinato mat white	 F4 cromo chrome  F1 ottone lucido polished brass  F8 cromo spazzolato brushed chrome	 PATENT Ø 52 mm  YALE Ø 52 mm  WC Ø 52 mm











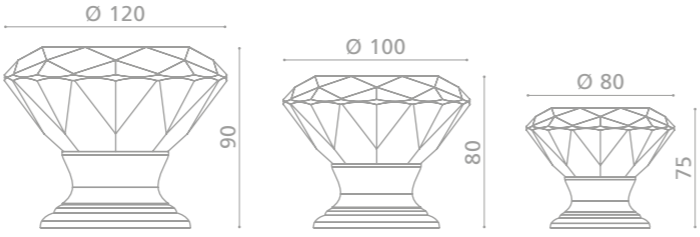





# PULL & PUSH

nome name	misura-Ø measures-Ø	col. cristallo crystal colour	finit. ottone brass finish
<input type="text"/>	<input type="text"/>	<input type="text"/>	<input type="text"/>

## ESEMPIO DI ORDINE ORDER EXAMPLE

L'ordine si intende per pezzo singolo senza bocchetta chiave - The order is considered for single unit without key rosette





Nome Name	Misura Measures	Colore cristallo Crystal colour	Finitura ottone Brass finish
 <p><b>DELUXE</b> Pull &amp; Push</p> <p><small>Cristallo DE MEDICI Pb 24%</small></p>		 <p>T01 trasparente clear</p>	 <p>F4 cromo chrome</p>  <p>F1 ottone lucido polished brass</p>
 <p><b>MARGHERITA</b> Pull &amp; Push</p> <p><small>Cristallo DE MEDICI Pb 24%</small></p>		 <p>T01 trasparente clear</p>	 <p>F4 cromo chrome</p>  <p>F1 ottone lucido polished brass</p>
 <p><b>STELLA</b> Pull &amp; Push</p> <p><small>Cristallo DE MEDICI Pb 24%</small></p>		 <p>T01 trasparente clear</p>	 <p>F4 cromo chrome</p>  <p>F1 ottone lucido polished brass</p>

# POMOLI *KNOBS*

nome name	misura-Ø measures-Ø	finit. ottone brass finish	col. cristallo crystal colour
<input type="text"/>	<input type="text"/>	<input type="text"/>	<input type="text"/>

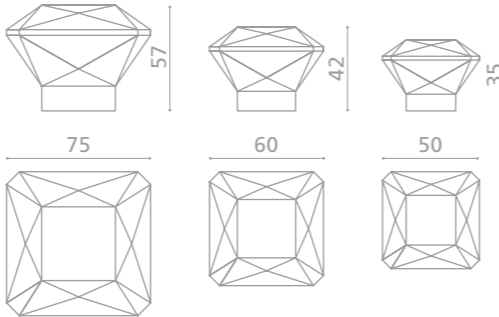
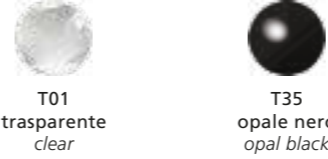
## ESEMPIO DI ORDINE *ORDER EXAMPLE*

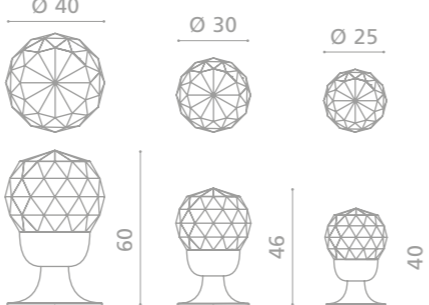
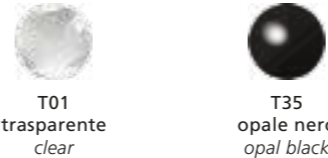
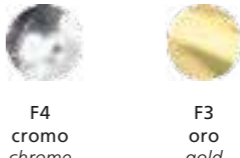
L'ordine si intende per pezzo singolo - *The order is considered for single unit*

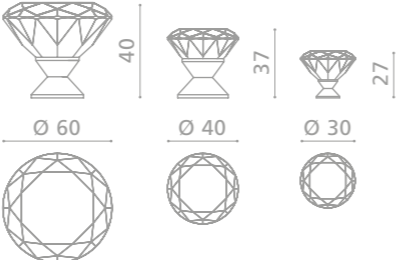
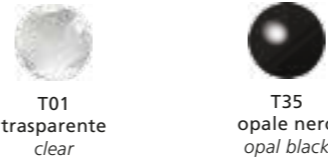
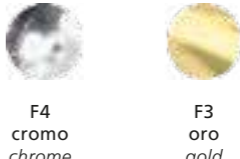
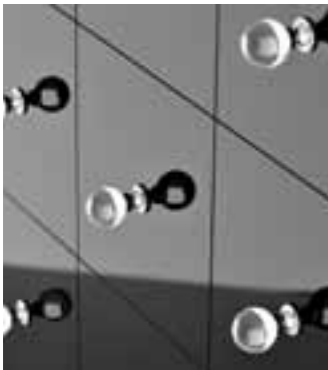
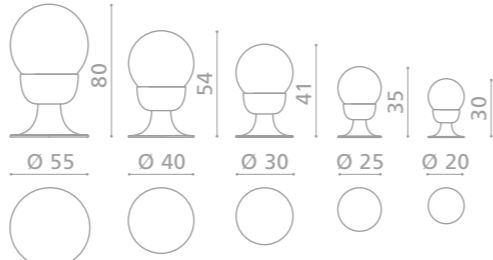
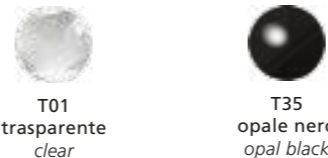
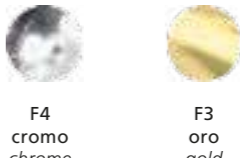



Nome Name	Misura Measures	Colore cristallo Crystal colour	Finitura ottone Brass finish
 <p><b>DIAMOND</b> Pull</p> <p><small>Cristallo DE MEDICI Pb 24%</small></p>		 <p>T01 trasparente clear</p> <p>T35 opale nero opal black</p>	 <p>F4 cromo chrome</p> <p>F1 ottone lucido polished brass</p> <p>F8 cromo spazzolato brushed chrome</p>
 <p><b>GEO</b> Pull</p> <p><small>Cristallo DE MEDICI Pb 24%</small></p>		 <p>T01 trasparente clear</p> <p>T35 opale nero opal black</p>	 <p>F4 cromo chrome</p> <p>F3 oro gold</p>
 <p><b>DELUXE</b> Knob</p> <p><small>Cristallo DE MEDICI Pb 24%</small></p>		 <p>T01 trasparente clear</p> <p>T35 opale nero opal black</p>	 <p>F4 cromo chrome</p> <p>F3 oro gold</p>
 <p><b>SFERA</b> Pull</p> <p><small>made with MURANO glass</small></p>		 <p>T01 trasparente clear</p> <p>T35 opale nero opal black</p>	 <p>F4 cromo chrome</p> <p>F3 oro gold</p>

# POMOLI *KNOBS*

## ESEMPIO DI ORDINE *ORDER EXAMPLE*

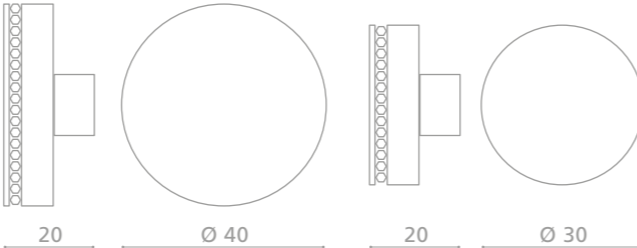
nome name	col. cristallo crystal colour	finit. ottone brass finish	misura-Ø measures-Ø
<input type="text"/>	<input type="text"/>	<input type="text"/>	<input type="text"/>

L'ordine si intende per pezzo singolo - *The order is considered for single unit*

















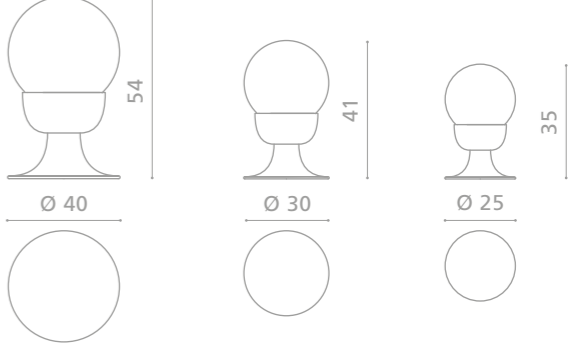











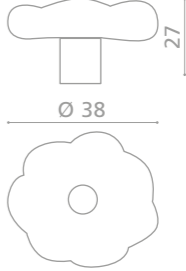



Nome <i>Name</i>	Misura <i>Measures</i>	Colore - colore cristallo <i>Crystal colour</i>	Finitura ottone <i>Brass finish</i>
 <p><b>PERLA</b> Lux</p> <p>Madreperla e Swarovsky <i>Mother of Pearl and Swarovsky</i></p>	 <p>20      Ø 40      20      Ø 30</p>	 <p><b>MPSW</b> madreperla Swarovsky <i>white mother of pearl Swarovsky</i></p>  <p><b>SMSW</b> madreperla smoke Swarovsky <i>smoke mother of pearl Swarovsky</i></p>	 <p><b>F4</b> cromo <i>chrome</i></p>  <p><b>F3</b> oro <i>gold</i></p>
 <p><b>PERLA</b> Tondo</p> <p>Madreperla e Corno <i>Mother of Pearl and Horn</i></p>	 <p>20      Ø 40      20      Ø 30</p>	 <p><b>MP</b> madreperla <i>white mother of pearl</i></p>  <p><b>SM</b> madreperla smoke <i>smoke mother of pearl</i></p>  <p><b>CR</b> corno <i>horn</i></p>	 <p><b>F4</b> cromo <i>chrome</i></p>  <p><b>F3</b> oro <i>gold</i></p>
 <p><b>PERLA</b> Quadro</p> <p>Madreperla e Corno <i>Mother of Pearl and Horn</i></p>	 <p>20      40      20      30</p>	 <p><b>MP</b> madreperla <i>white mother of pearl</i></p>  <p><b>SM</b> madreperla smoke <i>smoke mother of pearl</i></p>  <p><b>CR</b> corno <i>horn</i></p>	 <p><b>F4</b> cromo <i>chrome</i></p>  <p><b>F3</b> oro <i>gold</i></p>
 <p><b>SFERA</b> P907</p> <p>made with <b>MURANO</b> glass</p>	 <p>Ø 44      41</p>	 <p><b>S01</b> satinato <i>mat white</i></p>  <p><b>T35</b> opale nero <i>opal black</i></p>	 <p><b>F4</b> cromo <i>chrome</i></p>  <p><b>F3</b> oro <i>gold</i></p>

# POMOLI KNOBS

nome name col. cristallo crystal colour finit. ottone brass finish misura-Ø measures-Ø

## ESEMPIO DI ORDINE ORDER EXAMPLE

L'ordine si intende per pezzo singolo - The order is considered for single unit

Nome Name	Colore cristallo Crystal colour	Finitura ottone Brass finish	Misura Measures
 <p><b>Murano</b> Knob</p> 	 <p><b>ARG</b> trasparente / foglia argento clear / silver leaf</p>  <p><b>ORO</b> trasparente / foglia oro clear / gold leaf</p>	 <p><b>F4</b> cromo chrome</p>  <p><b>F3</b> oro gold</p>	
 <p><b>DAISY</b></p> 	 <p><b>T01</b> trasparente clear</p>  <p><b>S01</b> satinato mat white</p>  <p><b>T24</b> oro gold</p>  <p><b>T25</b> platino platinum</p>  <p><b>G25</b> giallo yellow</p>  <p><b>G29</b> arancio orange</p>  <p><b>G23</b> verde green</p>  <p><b>G22</b> turchese turquoise</p>	 <p><b>F4</b> cromo chrome</p>  <p><b>F3</b> oro gold</p>	
 <p><b>P331</b></p> 	 <p><b>T01</b> trasparente clear</p>  <p><b>S01</b> satinato mat white</p>	 <p><b>F4</b> cromo chrome</p>  <p><b>F3</b> oro gold</p>	
 <p><b>P341</b></p> 	 <p><b>T01</b> trasparente clear</p>  <p><b>S01</b> satinato mat white</p>	 <p><b>F4</b> cromo chrome</p>  <p><b>F3</b> oro gold</p>	



# POMOLI KNOBS

nome name	col. cristallo crystal colour	finit. ottone brass finish	misura-Ø measures-Ø
<input type="text"/>	<input type="text"/>	<input type="text"/>	<input type="text"/>

## ESEMPIO DI ORDINE ORDER EXAMPLE

L'ordine si intende per pezzo singolo - The order is considered for single unit



Nome Name	Colore cristallo Crystal colour	Finitura ottone Brass finish	Misura Measures
 <p><b>P901</b></p> <p>Florence Glass <b>ATELIER</b></p>	 <p>T01 trasparente clear</p>	 <p>F4 cromo chrome</p>  <p>F3 oro gold</p>	<p>Ø 30-40</p> 
 <p><b>P365</b></p> <p>Florence Glass <b>ATELIER</b></p>	 <p>T01 trasparente clear</p>  <p>S01 satinato mat white</p>	 <p>F4 cromo chrome</p>  <p>F3 oro gold</p>	<p>Ø 25-30-40</p> 
 <p><b>P330</b></p> <p>Florence Glass <b>ATELIER</b></p>	 <p>T01 trasparente clear</p>  <p>S01 satinato mat white</p>	 <p>F4 cromo chrome</p>  <p>F3 oro gold</p>	<p>Ø 25-30-40</p> 
 <p><b>P333</b></p> <p>Florence Glass <b>ATELIER</b></p>	 <p>T01 trasparente clear</p>  <p>S01 satinato mat white</p>	 <p>F4 cromo chrome</p>  <p>F3 oro gold</p>	<p>Ø 25-30-40</p> 

# POMOLI KNOBS

nome name col. cristallo crystal colour finit. ottone brass finish misura-Ø measures-Ø

## ESEMPIO DI ORDINE ORDER EXAMPLE

L'ordine si intende per pezzo singolo - The order is considered for single unit

Nome Name	Colore cristallo Crystal colour	Finitura ottone Brass finish	Misura Measures
 <p>P909</p> <p>Florence Glass ATELIER®</p>	 <p>T01 trasparente clear</p>	 <p>F4 cromo chrome</p>  <p>F3 oro gold</p>	<p>Ø 25-35-45</p> 
 <p>P367</p> <p>Florence Glass ATELIER®</p>	 <p>T01 trasparente clear</p>  <p>S01 satinato mat white</p>	 <p>F4 cromo chrome</p>  <p>F3 oro gold</p>	<p>Ø 30 H 47</p> 
 <p>P906</p> <p>Florence Glass ATELIER®</p>	 <p>T01 trasparente clear</p>  <p>S01 satinato mat white</p>	 <p>F4 cromo chrome</p>  <p>F3 oro gold</p>	<p>Ø 20</p> 
 <p>P405</p> <p>Florence Glass ATELIER®</p>	 <p>T01 trasparente clear</p>  <p>S01 satinato mat white</p>	 <p>F4 cromo chrome</p>  <p>F3 oro gold</p>	<p>Ø 25-30</p> 

# POMOLI KNOBS

nome name	col. cristallo crystal colour	finit. ottone brass finish	misura-Ø measures-Ø
<input type="text"/>	<input type="text"/>	<input type="text"/>	<input type="text"/>

## ESEMPIO DI ORDINE ORDER EXAMPLE

L'ordine si intende per pezzo singolo - The order is considered for single unit

Nome Name	Colore cristallo Crystal colour	Finitura ottone Brass finish	Misura Measures
 <p><b>P337</b> Florence Glass ATELIER®</p>	 T01 trasparente clear  S01 satinato mat white	 F4 cromo chrome  F3 oro gold	<p>Ø 25-30-40</p> 
 <p><b>P351</b> Florence Glass ATELIER®</p>	 S01 satinato mat white	 F4 cromo chrome  F3 oro gold	<p>Ø 40</p> 
 <p><b>P342</b> Florence Glass ATELIER®</p>	 T01 trasparente clear  S01 satinato mat white	 F4 cromo chrome  F3 oro gold	<p>Ø 25-30-40</p> 
 <p><b>P336</b> Florence Glass ATELIER®</p>	 T01 trasparente clear  S01 satinato mat white	 F4 cromo chrome  F3 oro gold	<p>Ø 25-30-40</p> 

nome name col. cristallo crystal colour finit. ottone brass finish misura-Ø measures-Ø

## ESEMPIO DI ORDINE ORDER EXAMPLE

L'ordine si intende per pezzo singolo - The order is considered for single unit

Nome Name	Colore cristallo Crystal colour	Finitura ottone Brass finish	Misura Measures
 <p><b>P332</b></p> <p>Florence Glass <b>ATELIER</b></p>	 <p>T01 trasparente clear</p>  <p>S01 satinato mat white</p>	 <p>F4 cromo chrome</p>  <p>F3 oro gold</p>	<p>Ø 25-30-40</p> 
 <p><b>P334</b></p> <p>Florence Glass <b>ATELIER</b></p>	 <p>T01 trasparente clear</p>  <p>S01 satinato mat white</p>	 <p>F4 cromo chrome</p>  <p>F3 oro gold</p>	<p>Ø 25-30-40</p> 
 <p><b>FROZEN</b></p> <p>Florence Glass <b>ATELIER</b></p>	 <p>T36 trasparente madreperla clear with mother of pearl</p>  <p>T23 verde chiaro pale green</p>  <p>T20 acquamarina marine</p>  <p>T37 ambra amber</p>	 <p>F4 cromo chrome</p>  <p>F3 oro gold</p>	<p>25x25</p> 













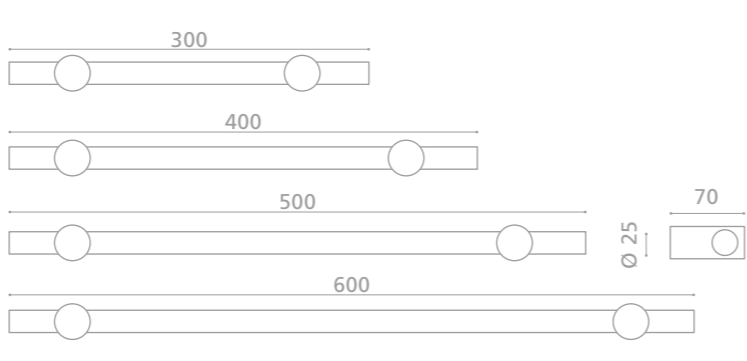

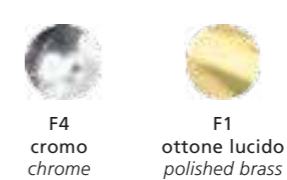

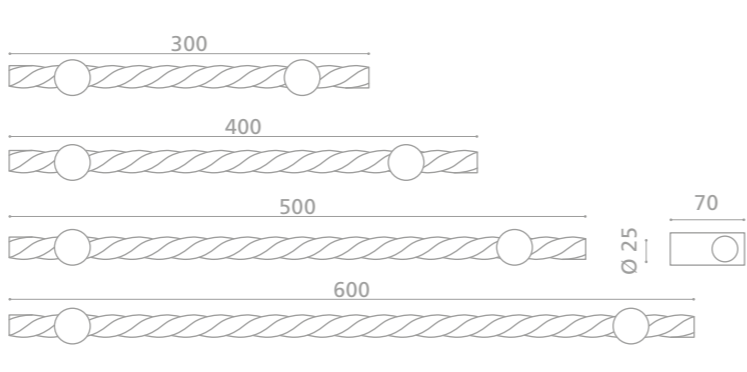
# MANIGLIONI / MANIGLIETTE

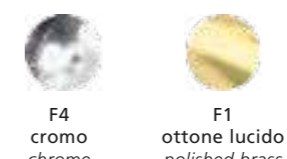
# PULL HANDLES / FURNITURE HANDLES

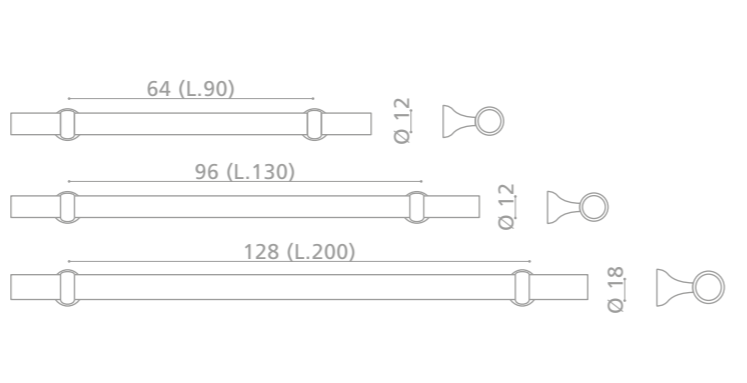
## ESEMPIO DI ORDINE ORDER EXAMPLE

nome name	misura-Ø measures-Ø	col. cristallo crystal colour	finit. ottone brass finish
<input type="text"/>	<input type="text"/>	<input type="text"/>	<input type="text"/>

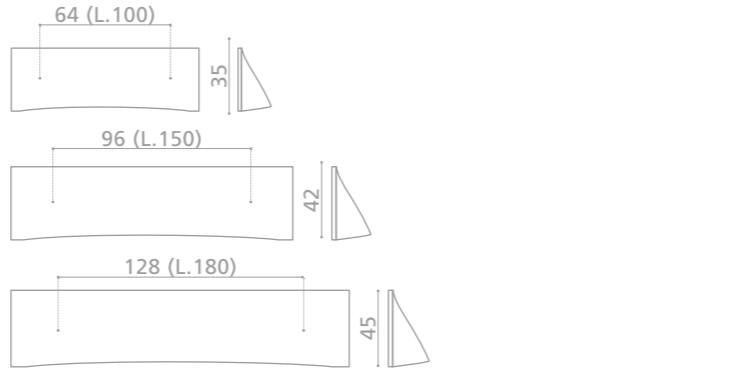







L'ordine si intende per pezzo singolo - The order is considered for single unit

Nome Name	Misura Measures	Colore cristallo Crystal colour	Finitura ottone Brass finish
 <p><b>PROFILI</b></p> <p>Cristallo DE'MEDICI Pb 24%</p>		 <p>T01 trasparente clear</p> <p>S01 satinato mat white</p>	 <p>F4 cromo chrome</p> <p>F1 ottone lucido polished brass</p>
 <p><b>TORCÉ</b></p> <p>Cristallo DE'MEDICI Pb 24%</p>		 <p>T01 trasparente clear</p>	 <p>F4 cromo chrome</p> <p>F1 ottone lucido polished brass</p>
 <p><b>M510</b></p> <p>Cristallo DE'MEDICI Pb 24%</p>		 <p>T01 trasparente clear</p> <p>S01 satinato mat white</p> <p>TN1 linee sabbiate (solo su L. 200) mat lines (only on L. 200)</p>	 <p>F4 cromo chrome</p> <p>F3 oro gold</p>
 <p><b>FOGLIA</b></p> <p>The Luxury LEAF</p>		 <p>FA foglia argento silver leaf</p> <p>FO foglia oro gold leaf</p> <p>FR foglia rame copper leaf</p>	

nome name    col. cristallo crystal colour    finit. ottone brass finish    n° fori hole number

ESEMPIO DI ORDINE ORDER EXAMPLE

L'ordine si intende per pezzo singolo - The order is considered for single unit

Nome Name	Colore cristallo Crystal colour	Finitura ottone Brass finish	Misura Measures
 <p><b>TORCÉ</b> Coat</p> <p>Florence Glass <b>ATELIER</b></p>	<p>T01 trasparente clear    S01 satinato mat white</p>	<p>F4 cromo chrome    F1 ottone lucido polished brass</p>	 <p>Ø 68 120</p>
 <p><b>SFERA</b> Coat</p> <p>Florence Glass <b>ATELIER</b></p>	<p>S01 satinato mat white    T35 opale nero opal black    S18 blu satinato mat blue</p>	<p>F4 cromo chrome    F1 ottone lucido polished brass</p>	 <p>Ø40 106</p>
 <p><b>GEO</b> Coat</p> <p>Cristallo <b>DE MEDICI</b> Pb 24%</p>	<p>T01 trasparente clear    T35 opale nero opal black</p>	<p>F4 cromo chrome    F1 ottone lucido polished brass</p>	 <p>Ø40 106</p>
 <p><b>ENEA</b></p> <p>Cristallo <b>DE MEDICI</b> Pb 24%</p>	<p>T01 trasparente clear    S01 satinato mat white FA foglia argento silver leaf    FO foglia oro gold leaf</p>	<p>F4 cromo chrome    F1 ottone lucido polished brass</p>	 <p>165 105 1 foro 1 hole    2 fori 2 holes    3 fori 3 holes</p>

Disponibile per serie Magic della B-Ticino.  
Available for B-Ticino Magic series.

 **Cristallo  
DE' MEDICI**  
Pb 24%

Collezioni esclusive, realizzate in cristallo purissimo al 24% pb. Si tratta di prodotti raffinatissimi, colati a mano e molati a pietra con abilità, dai nostri maestri secondo le più antiche e nobili arti vetrarie. Nessuna macchina, nessuna tecnologia, ma solo prodotti d'arte, classici, contemporanei ... futuristici.

Exclusive collections created from pure crystal with 24% lead content. These utmost refined products born out of hand cast crystal, then bevelled in stone by our master artists according to the most ancient and noble glass arts. Neither machines nor technology are employed in the process, resulting in classical, contemporary or futuristic art products.



 **Florence Glass  
ATELIER**

Il progetto Atelier nasce dalla ricerca stilistica che una nostra equipe interna realizza rivolgendo lo sguardo al mondo della moda. I colori e le forme che vengono rappresentati nel programma sono la sintesi delle nuove tendenze.

The "Florence Glass Atelier" project is inspired by embedding the philosophy of the fashion world into product research. The focus lays on enhancing crystal material with colours and shapes of fashion trends.



 made with  
**MURANO**  
glass

Il vetro di Murano è da sempre sinonimo di raffinatezza, leggerezza ed eleganza. I maestri vetrai hanno saputo sviluppare tecniche di lavorazioni privilegiate, nel rispetto della millenaria tradizione che rende il vetro di Murano un prodotto unico, prestigioso e inimitabile.

Murano glass is a synonym for elegance and timelessness. By combining innovative techniques with traditional artisan workmanship, unique, prestigious and inimitable objects are created.



 **The Luxury  
LEAF**

La semplicità diventa unica...  
Tecnologia e lusso, questo è il nuovo connubio che permette ad un semplice oggetto di metallo di arricchirsi di valore e trasformarsi in un esclusivo ed elegante accessorio d'arredamento.

Simplicity becomes uniqueness...  
Technology and luxury, this is the new bond for a simple metal object, becoming an exclusive and elegant furnishing accessory.

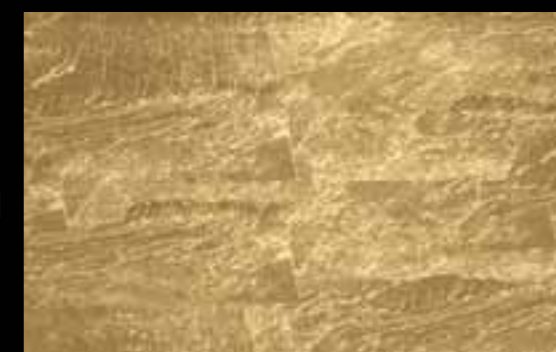

**Kerameia**

Da un materiale che affonda le sue origini nella storia più antica, unito all'arte dei maestri decoratori, nascono i prodotti in ceramica della serie KERAMEIA. Una base povera resa ricca dagli esclusivi decori in oro 37 kt e platino.

From a material that sinks its roots in the oldest history, combined with the art of master decorators, borns the KERAMEIA collection. Hand-made ceramic products enriched with an exclusive decoration in gold 37 kt and platinum.





CERTIFICAZIONI  
CERTIFICATIONS



GLASS DESIGN S.R.L.  
Via Limitese, 122/124 - 50053 Vinci (Firenze) ITALY  
Tel. +39 0571 902311 / +39 0571 902501  
Fax +39 0571 902312  
glassdesign@glassdesign.it | www.glassdesign.it

Copyright © Glass Design srl. Tutti i diritti riservati - All rights reserved.

Graphic and visual design:  
info@giacomomasoni.com

stampato su carta certificata FSC®



Il marchio FSC identifica i prodotti derivanti dal legno, provenienti da foreste gestite in maniera responsabile secondo rigorosi standard ambientali, sociali ed economici.

ARIUS®  
H O M E

*quando un oggetto diventa soggetto*  
*when an object becomes subject*



ARIUS<sup>®</sup>  
H O M E

[www.ariushome.it](http://www.ariushome.it)  
[www.glassdesign.it](http://www.glassdesign.it)