

DA VINCI TUSCANY

DA VINCI TUSCANY

DA VINCI TUSCANY

DA VINCI TUSCANY

DA VINCI TUSCANY

DA VINCI TUSCANY

DA VINCI TUSCANY



DA VINCI TUSCANY

BATH
HOLDING

DA VINCI TUSCANY

DA VINCI TUSCANY



Glass Design è un'eccellenza Italiana nella produzione e nel design di lavabi e complementi d'arredo bagno. *Glass Design is an Italian excellence in the production and design of bathroom washbasins and interior decoration furnishings.*

Situata a Vinci, cuore della Toscana e città di "Leonardo da Vinci", Glass Design è stata fondata nel 1984 dalla famiglia Borsellini, dopo una pluriennale esperienza nella manifattura del vetro artistico. *Located in Vinci, in the heart of Tuscany and native town of "Leonardo da Vinci", Glass Design was founded in 1984 by the Borsellini family, further to a long tradition in manufacturing artistic glass.*

Utilizzando materiali tecnologicamente avanzati, come il Silicio o l'Inox e, lavorando ad arte su materiali tradizionali, come il cristallo molato o il vetro artistico, Glass Design contribuisce alla creazione di un nuovo stile dove l'accessorio, curato nei minimi dettagli, diventa il soggetto principale dell'ambiente, un vero prodotto "moda", apprezzato nel mondo ed esportato in più di 60 paesi. *Both by using technologically advanced materials such as stainless steel or silicone, and by working in an artistic way with traditional materials like the formed 24%pb crystal and the artisan glass, the company Glass Design contributes to the creation of a new style, where even the accessory is addressed in all details, becoming the main subject of the environment, a true "fashion" product, highly appreciated in the world and exported to more than 60 countries.*

Oltre 200 artigiani Toscani e una quindicina di vetrai muranesi appartengono alla filiera produttiva aziendale, permettendo di adattare ogni prodotto ad esigenze e richieste specifiche del cliente, con infinite personalizzazioni realizzando così, prodotti unici ed esclusivi. *Over 200 Tuscan artisans and more than 15 glassmakers of Murano work within the company's production chain, enabling the customization of each product to suit individual needs and specific requirements, in order to create unique and exclusive products.*



FREESTANDING
Solutions

12/49



Sculture senza tempo
piene di contenuti creativi e culturali.
*Timeless sculptures
of creative and cultural contents.*

IN-OUT
Solutions

50/119



Emergenti sensazioni di design e lusso.
Emerging feelings of design and luxury.

MOBILI
Furniture Solutions

120/179



Affascinanti come i concetti che li ispirano.
As fascinating as the concepts that inspire them.

DOCCIA
Shower trays Solutions

180/239



Coordinati per una seduzione totale.
Coordinated for total seduction.

Accessori &
Complementi
Accessories &
Complements
242/247

Materiali
Materials
Certificazioni
Certifications
248/253

FREESTANDING *Solutions*



Isola
14-17

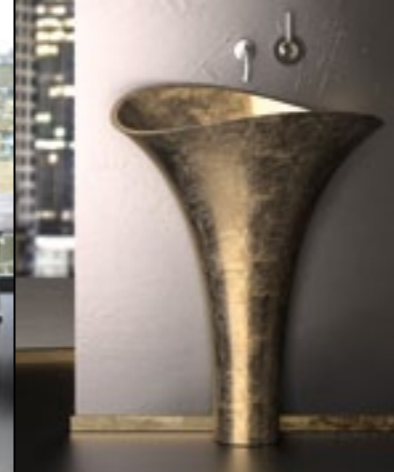

FLOwer **E**volution
18-22



FLOwer style
23-25



Roma **ALTO**
26-29



Roma **STYLE**
30-31



Tom **T**om
32-33



Tom **T**om 2
34-35

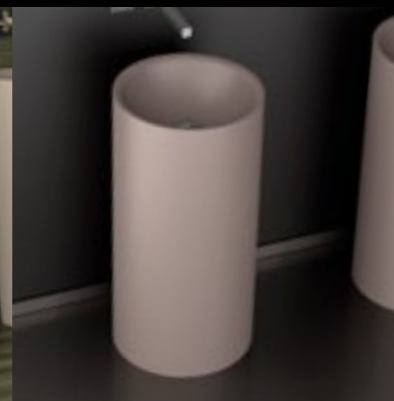

Tommy
36-38



Mini **B**ATHTUB
39-41



Specifiche
Data sheet

44-49



IN-OUT *Solutions*

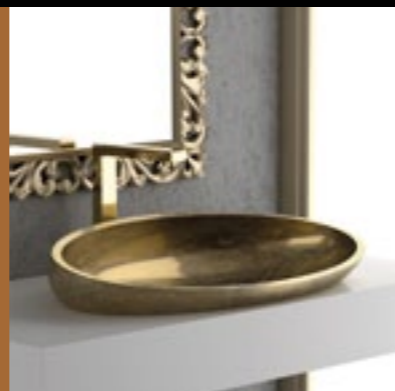

Kool XL FL
52-53

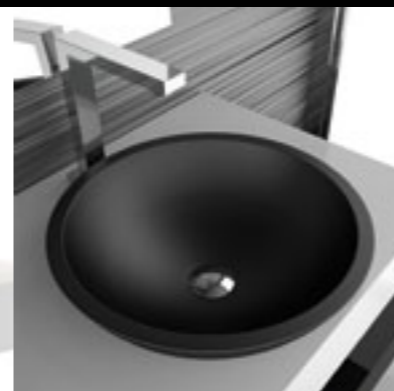

Circus 43 FL
54-55



Circus 50 FL
56-57



Open
58-59



Italy FL
60-61



Riv FL
62-63



Kosta I
64-65



Kosta II
66-67

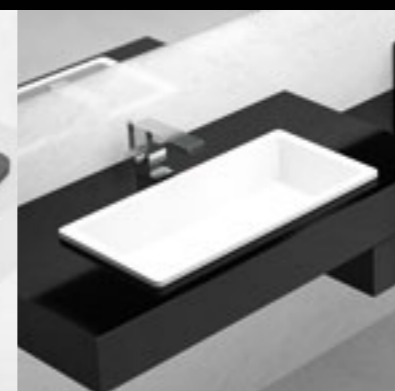

Rx
68-69



VOLcano FL
70-71



Jimmy FL
72-73

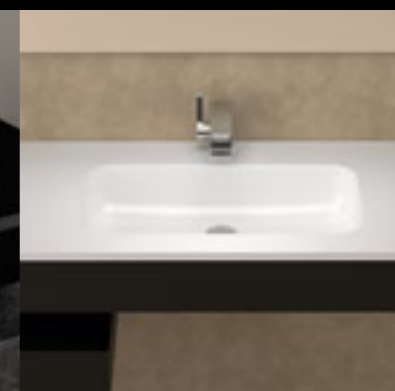

Jimmy In
74-75



Ellisse FL small - large - xl
76-77



Tondo FL
78-79



Naxos FL
80-81



Specifiche
Data sheet

84-89



Top porta-lavabo
Cassettiere sospese
Colonne sospese

SINTESI

Top for washbasin
Suspended drawer element
Suspended tall cabinet

90-93



SOTTO

94-119

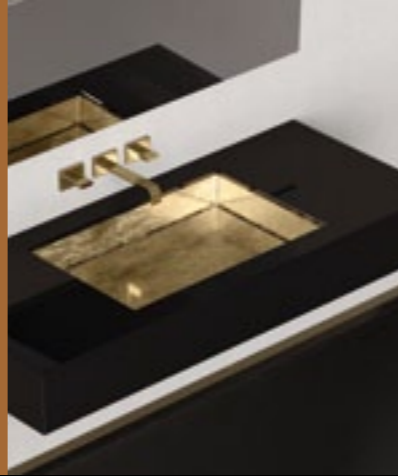

Blade sotto
96-97

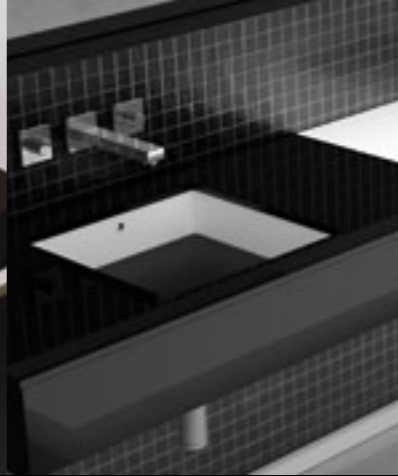

Four sotto
98-99



Rho sotto
100-101



Flou sotto
102-103



Bolla sotto
104-105



Yacht sotto
106-107



Specifiche
Data sheet

108-119



MOBILI
Furniture Solutions

MONNALISA



Monnalisa **P**restige
124-129



Monnalisa **F**lorence
131-133



Monnalisa **C**lass
134-137

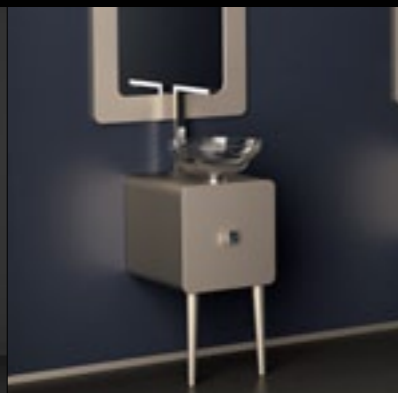

Misura **U**NO
138-141



Misura **D**UE
142-145



Misura **T**RE
146-149

LEONARDO



Cubus
152-157

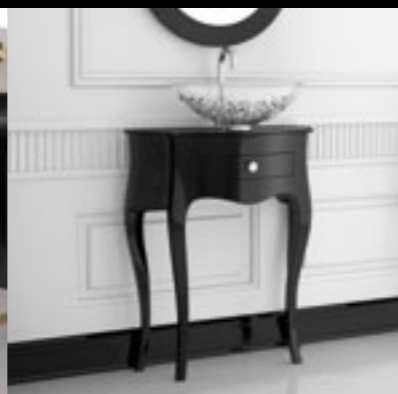

Canto **S**MALL
158-161

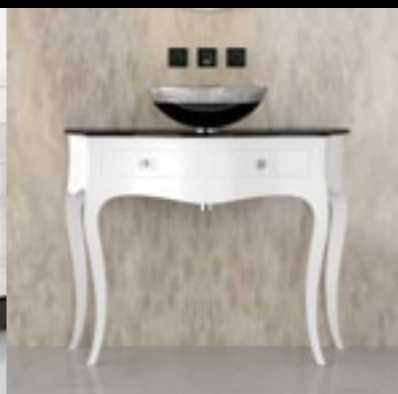

Canto **X**L
162-165



Koin **M**EDIO
166-171



Koin **X**L
172-177

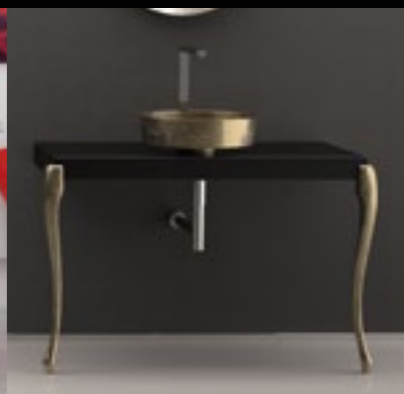

Musa
178-179

DOCCIA
Shower trays Solutions

NATURA
LUX



Natura LUX Gold

184-189 Natura LUX Silver

190-191

192-193

Specifiche
Data sheet

TERRA
LUX



Terra LUX Silver

196-201 Terra LUX Gold

202-203

204-205

Specifiche
Data sheet

NATURA



Natura Wengé

208-213 Natura Rovere

214-215

216-217

Specifiche
Data sheet

Piatti doccia e
Top porta-lavabo
coordinati

TERRA

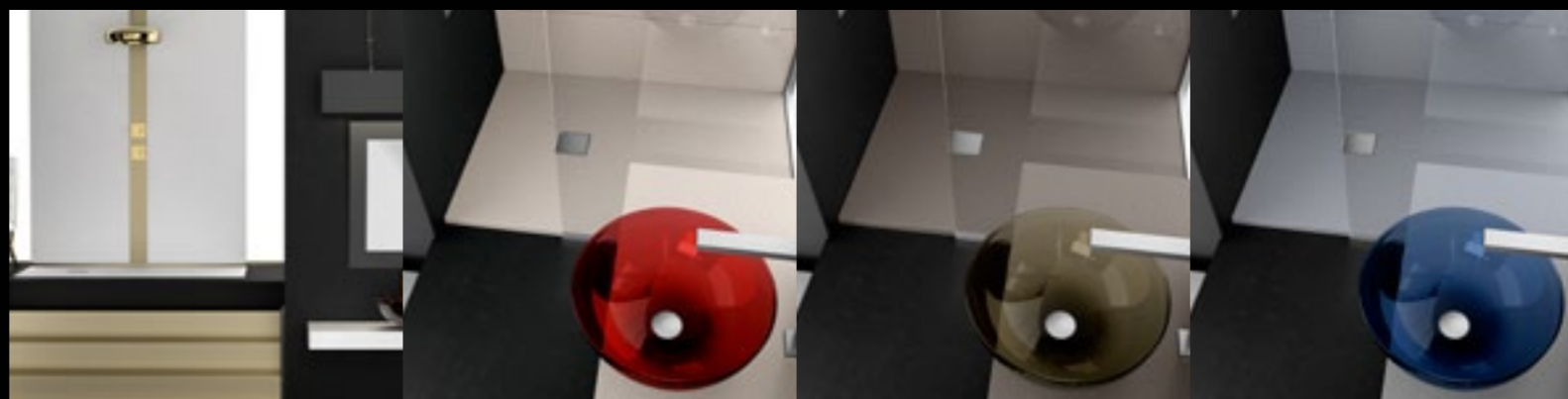

Terra Bianco 220-225

Terra Beige
226-227

Terra Tortora
228-229

Terra Grigio
230-231

232-237

Specifiche
Data sheet

Shower trays matching
with tops for washbasin



DV[®]
DA VINCI
TUSCANY

FREESTANDING SOLUTIONS



I Freestanding della Glass Design nascono dalla passione e dall'impegno di dar vita a molto di più di un semplice lavabo ma ad una vera e propria scultura da terra. Un prodotto essenziale, impreziosito dalle più esclusive colorazioni e finiture che lo rendono il vero protagonista dell'ambiente.

Freestanding washbasins from Glass Design are borne from a passion and commitment to create more than just a simple washbasin but rather a real sculpture from the ground up. This essential product is embellished by exclusive colours and finishes making it a true protagonist of its environment.

Isola

made with
MURANO[®]
glass



DV 14



15 DV

Lavabo freestanding in vetro di Murano bianco opale satinato con luci Led *Murano glass freestanding washbasin mat opal white with Led lighting set:*
code **ISOLAS36L**

Freestanding

Solutions

design by Alessandro Lenarda

Isola

made with
MURANO[®]
glass

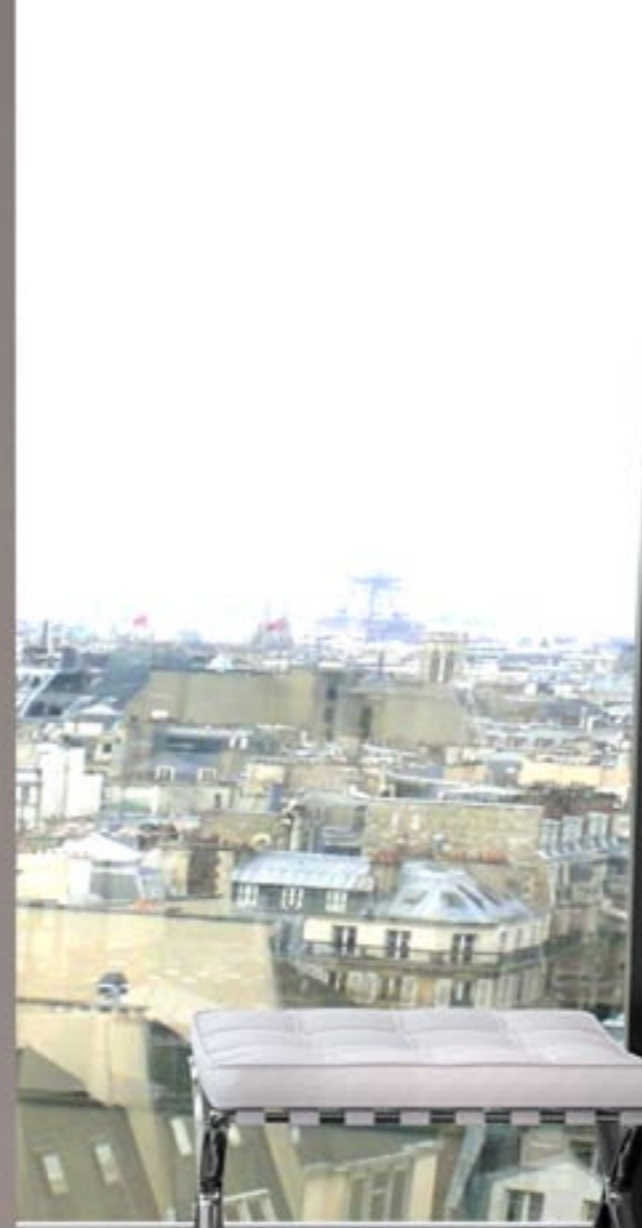
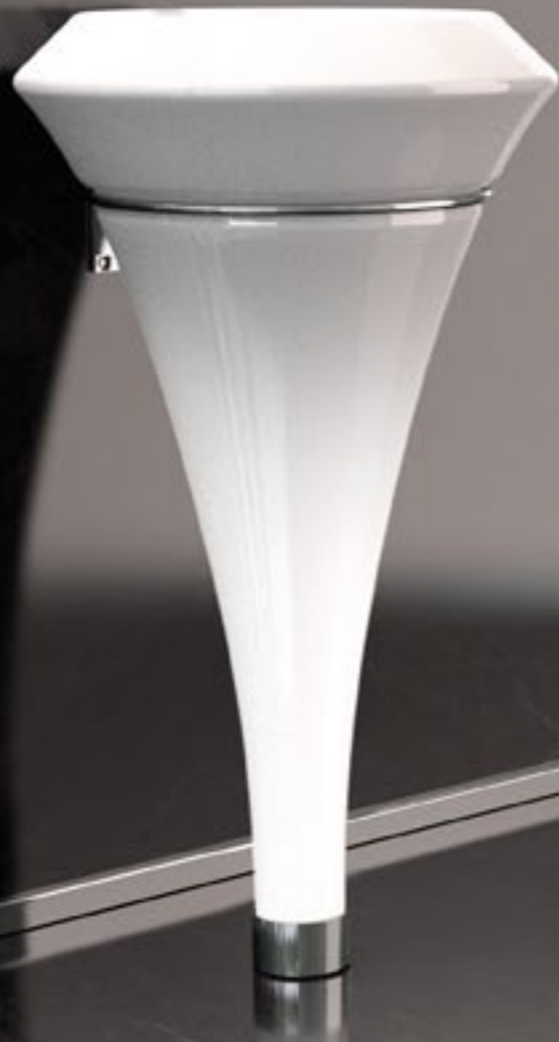

FLOwer

Evolution

VetroFreddo®

DV 18

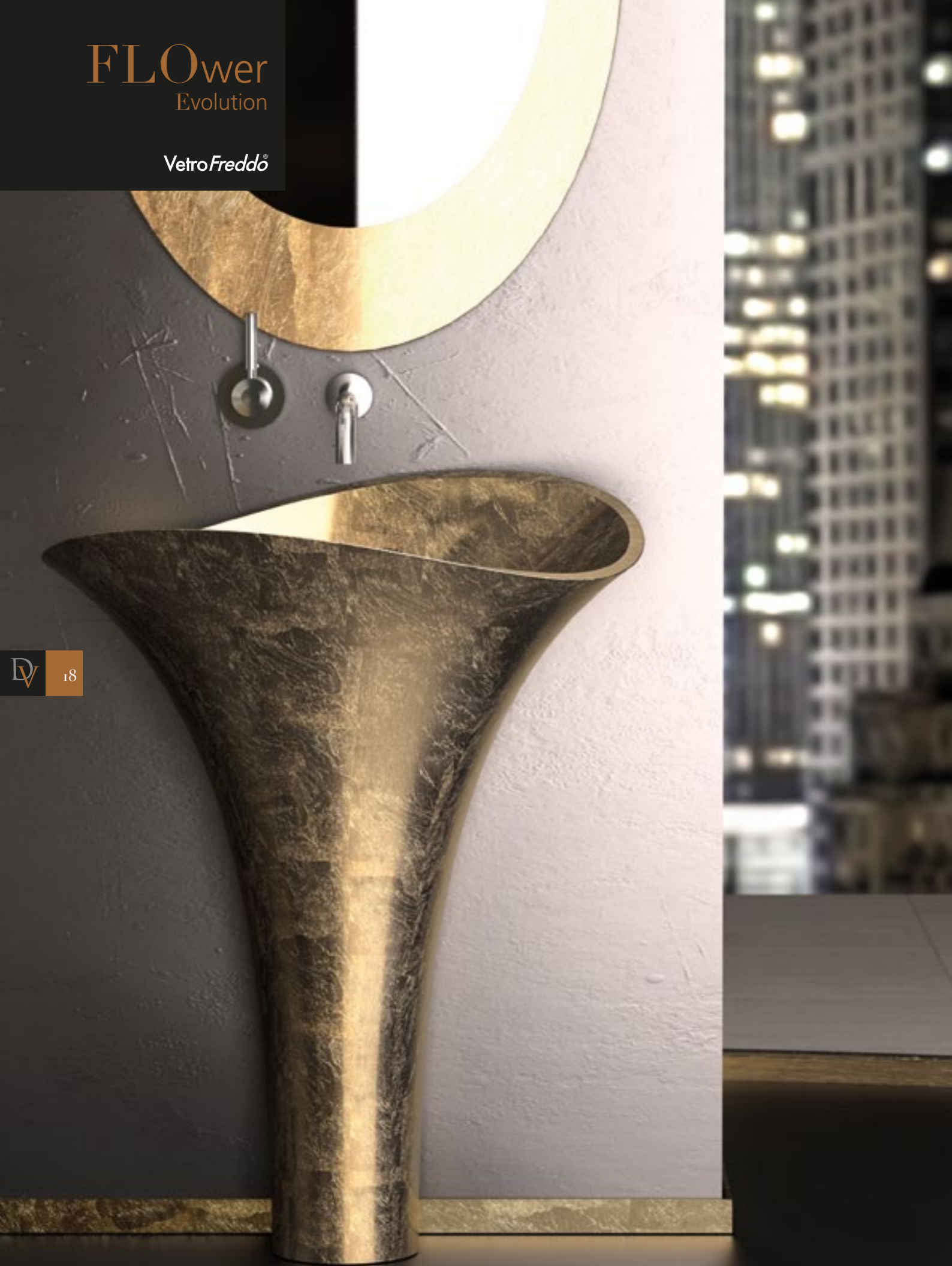

Lavabo freestanding in **VetroFreddo** foglia oro *Freestanding washbasin VetroFreddo gold leaf*: code **FLOEVOFO**
Specchio ovale foglia oro *Oval mirror gold leaf*, size 95x65 cm: code **FLOMIROVFO**



19 DV

Lavabo freestanding in **VetroFreddo** nero *Freestanding washbasin VetroFreddo black mat*: code **FLOEVOPO30**
Elemento in legno MDF con cassetto foglia oro. Apertura push&pull. *Furniture element with drawer gold leaf in MDF wood. Push&pull opening*:
code **SINCA100FO**
Specchio tondo nero opaco *Round mirror black mat*, size Ø70 cm:
code **FLOMIRRONO**

design by Marco Pisati

FLOwer

Evolution

VetroFreddo®

FLOWER style

Bi-mat



Lavabo freestanding in **Vetro Freddo** nero opaco Freestanding washbasin **Vetro Freddo** black mat: code **FLOEVOPO30**

Vasca da bagno in "Bi-mat" nero opaco con interno bianco lucido Bathtub "Bi-mat" black mat finish, white gloss inside: code **FLOSTYBLW**



Vasca da bagno in "Bi-mat" rosso Ferrari con interno bianco lucido
Bathtub "Bi-mat" Ferrari red finish, white gloss inside
code **FLOSTYRDW**

Roma
ALTO

TeknoForm®

DV 26



Lavabo freestanding in TeknoForm® foglia oro Freestanding washbasin TeknoForm® gold leaf: code **ROMAALFO**
Specchio ovale foglia oro Oval mirror gold leaf, size 95x65 cm: code **FLOMIROVFO**

27 DV



Vasca da bagno in "Bi-mat" foglia oro con interno bianco lucido Bathtub "Bi-mat" gold leaf finish, white gloss inside: code **ROMASTYFOW**

Freestanding

Solutions

design by Cairoli - Donzelli

Roma
ALTO

TeknoForm®

DV 28

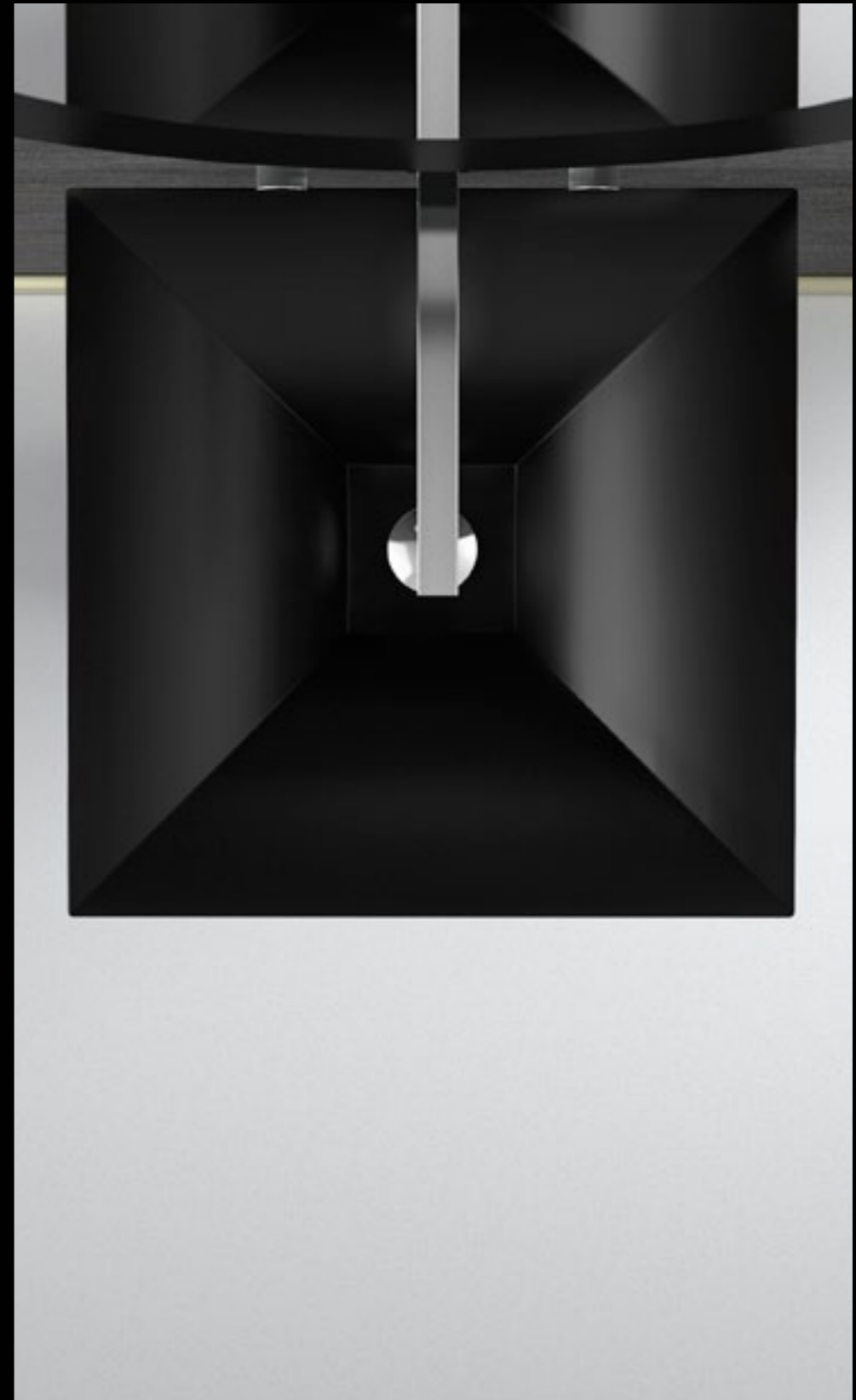

29 DV

Lavabo freestanding in TeknoForm® nero opaco Freestanding washbasin TeknoForm® black mat:
code ROMAALPO30

Roma style

Bi-mat



DV 30



31 DV

Vasca da bagno in "Bi-mat" rosso Ferrari con interno bianco lucido
Bathtub "Bi-mat" Ferrari red finish, white gloss inside:
code **ROMASTYRDW**

Lavabo freestanding in TeknoForm® rosso Ferrari
Freestanding washbasin TeknoForm® Ferrari red:
code **ROMAALPL34**

Specchio ovale rosso Ferrari
Oval mirror Ferrari red, size 95x65 cm:
code **FLOMIROVPL34**

Vasca da bagno in "Bi-mat" rosso Ferrari con interno bianco lucido Bathtub "Bi-mat" Ferrari red finish, white gloss inside: code **ROMASTYRDW**

Freestanding

Solutions



Lavabo freestanding in Alumix bianco/ argento Freestanding washbasin Alumix white/silver: code **ALUTOMTOMA05**

Tom Tom 2

VetroFreddo®



Tommy

VetroFreddo®

DV 36

37 DV

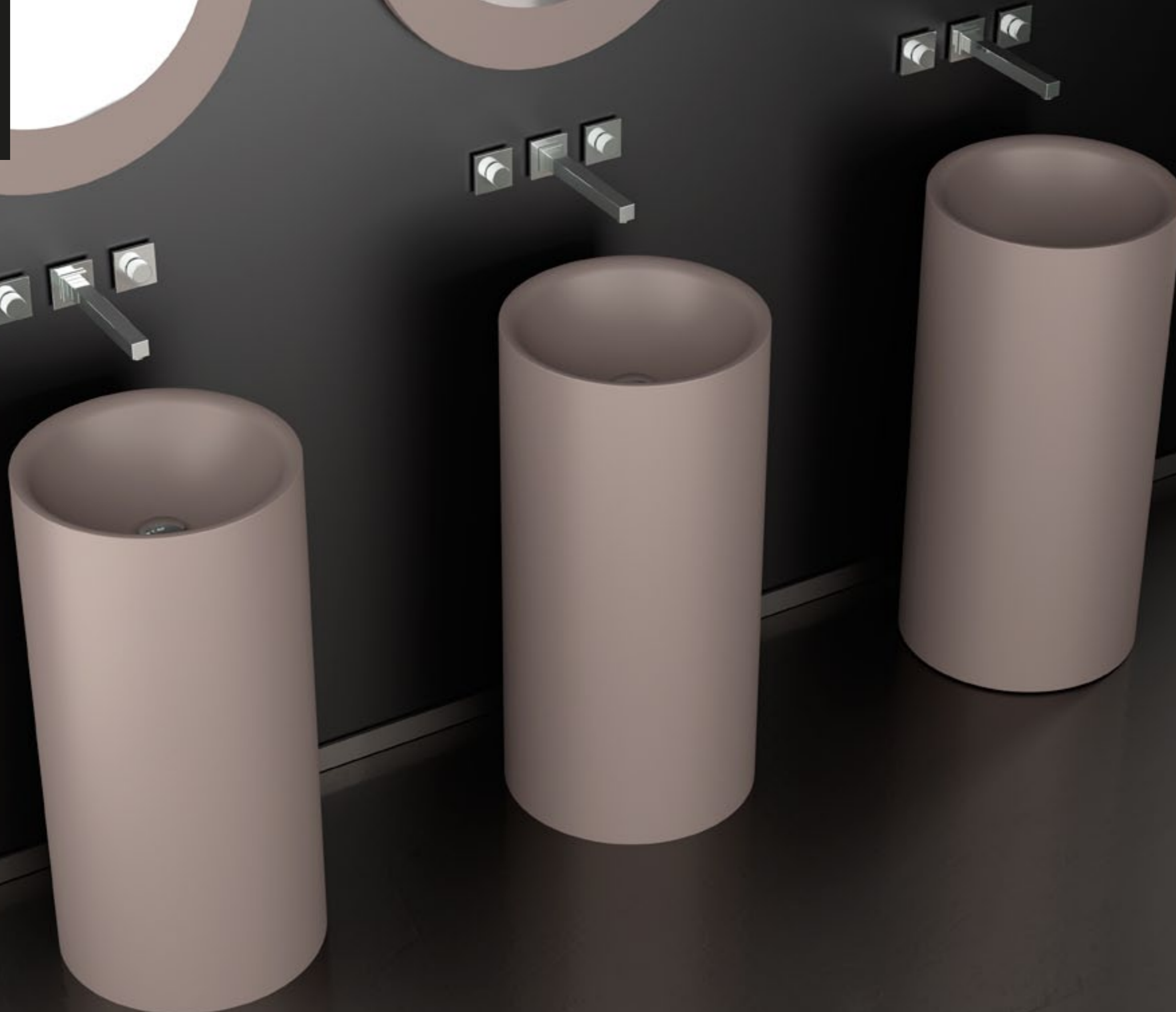

Lavabo freestanding in VetroFreddo® tortora Freestanding washbasin VetroFreddo® tortora colour: code TOMMYTR
Specchio tondo laccato tortora Round mirror tortora colour size Ø70 cm: code FLOMIRROTR

Freestanding

Solutions

Mini
BATHTUB

Bi-mat



DV 38

39 DV



design by Marco Pisati

Lavabo freestanding in **VetroFreddo** rosso Ferrari Freestanding washbasin **VetroFreddo** Ferrari red: code **TOMMYPL34**
Vasca da bagno in "Bi-mat" rosso Ferrari con interno bianco lucido Bath tub "Bi-mat" Ferrari red finish, white gloss inside: code **MINIRDW**

Freestanding

Solutions

Mini
BATHTUB

Bi-mat



Vasca da bagno in "Bi-mat" tortora con interno bianco lucido *Bathtub "Bi-mat" tortora colour, white gloss inside: code MINITRW*
Lavabo freestanding in *VetroFreddo* tortora *Freestanding washbasin VetroFreddo tortora colour: code TOMMYTR*

Freestanding

Solutions

design by Marco Pisati



“specifiche”
data sheet



ISOLA

made with
MURANO®
glass

design by:
ALESSANDRO LENARDA

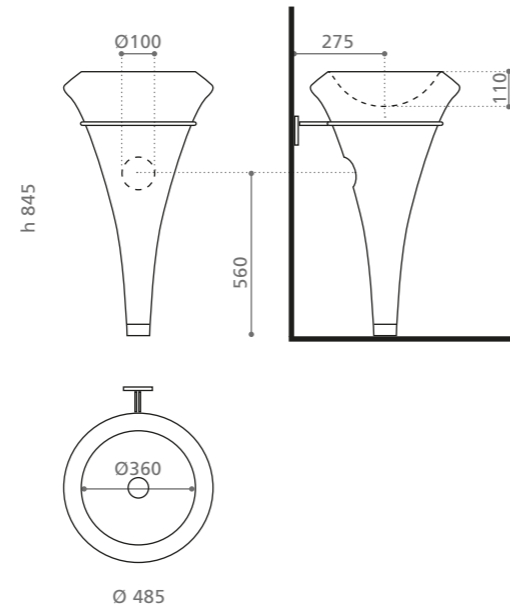

Ø foro / hole = 45 mm
peso / weight = 10,00 kg



opal white
ISOLAT36L



opal white mat
ISOLAS36L

Completo di illuminazione led e trasformatore *Led light and transformer included*

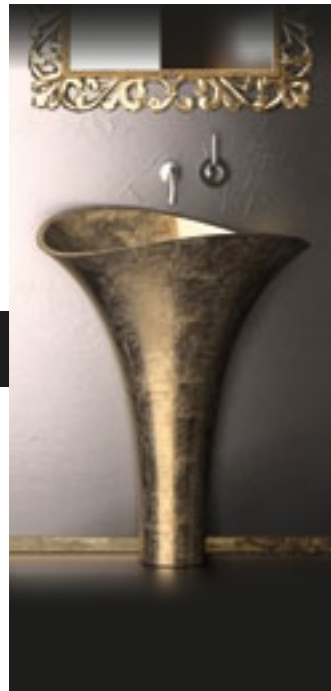

FLOWer Evolution

VetroFreddo®

design by:
MARCO PISATI
brevettato / patented

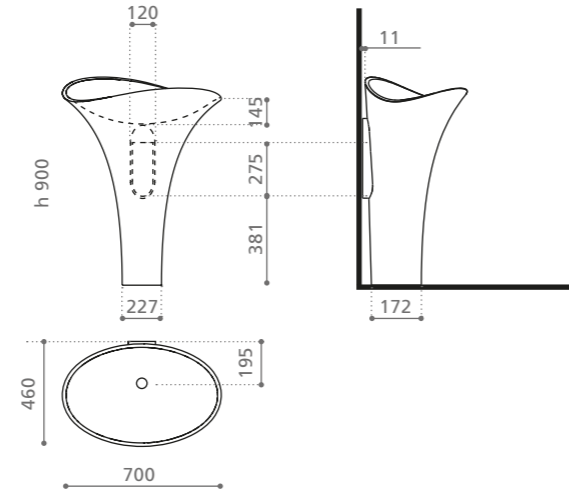

Ø foro / hole = 45 mm
peso / weight = 22,00 kg



white mat
FLOEVOPO01



black mat
FLOEVOPO30



Ferrari red
FLOEVOPL34



grey mat
FLOEVOGR



beige mat
FLOEVOBG



tortora mat
FLOEVOTR



gold leaf 3d
FLOEVOFO



silver leaf 3d
FLOEVOFA

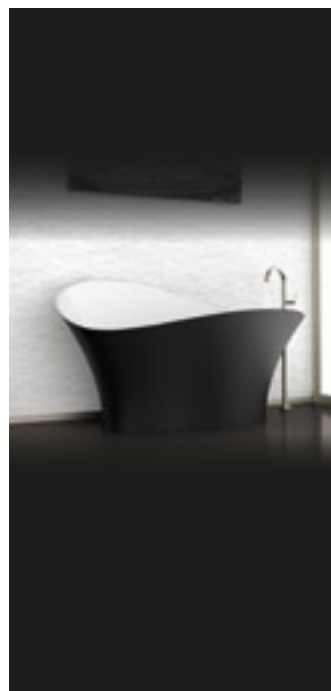

FLOWer style

Bi-mat

design by:
MARCO PISATI

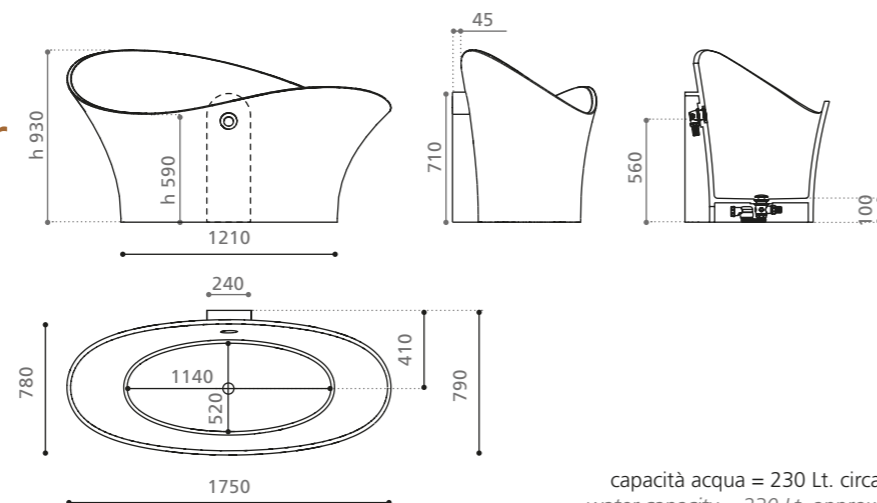

capacità acqua = 230 Lt. circa
water capacity = 230 Lt. approx.
peso / weight = 44,00 kg



white gloss
FLOSTYPL01



black mat/white gloss
FLOSTYBLW



Ferrari red/white gloss
FLOSTYRDW

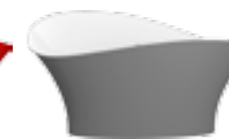

grey mat / white gloss
FLOSTYGRW



beige mat / white gloss
FLOSTYBGW



tortora mat / white gloss
FLOSTYTRW



gold leaf/white gloss
FLOSTYFOW



silver leaf/white gloss
FLOSTYFAW



ROMA

Alto

TeknoForm®

design by:
CAIROLI-DONZELLI

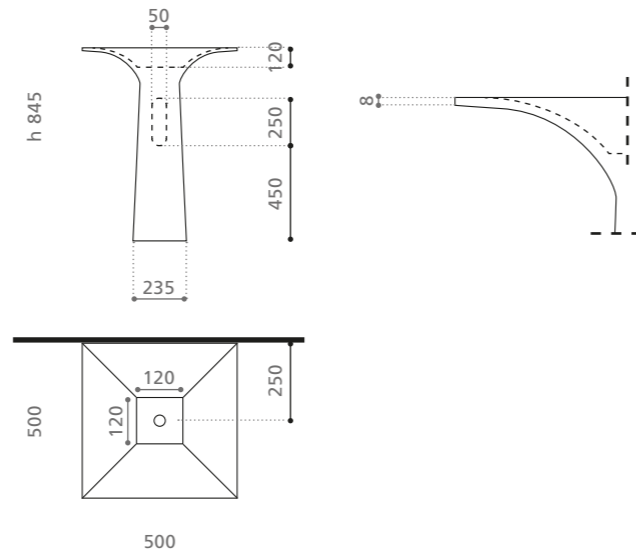

Ø foro / hole = 45 mm
peso / weight = 21,00 kg

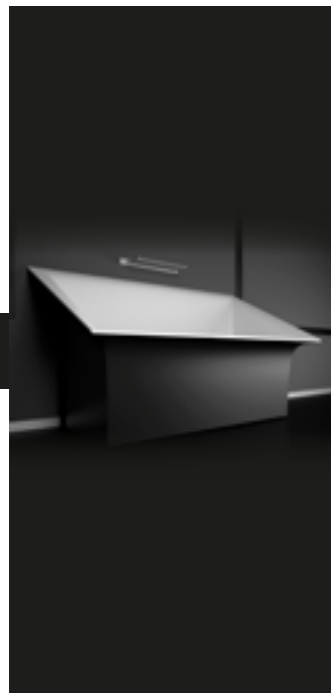

ROMA

style

Bi-mat

design by:
CAIROLI-DONZELLI

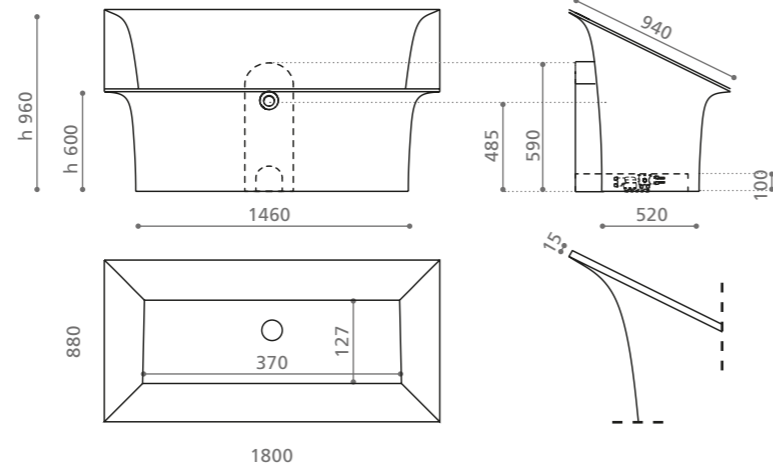

capacità acqua = 230 Lt. circa
water capacity = 230 Lt. approx.
peso / weight = 58,00 kg



TOM TOM

Alumix®

design by:
CAIROLI-DONZELLI

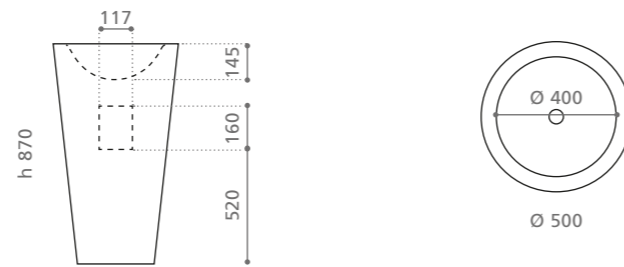

Ø foro / hole = 45 mm
peso / weight = 8,40 kg



TOM TOM 2

VetroFreddo®

design by:
CAIROLI-DONZELLI

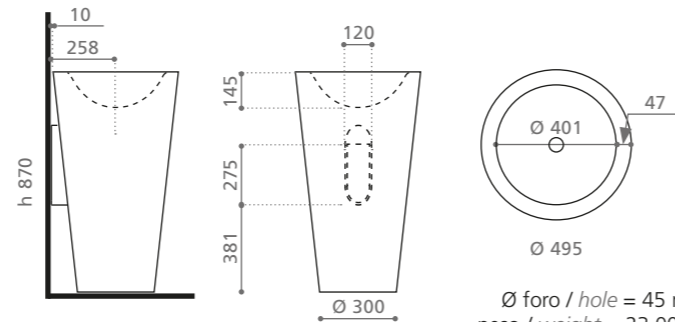

Ø foro / hole = 45 mm
peso / weight = 23,00 kg





TOMMY

Vetro Freddo®

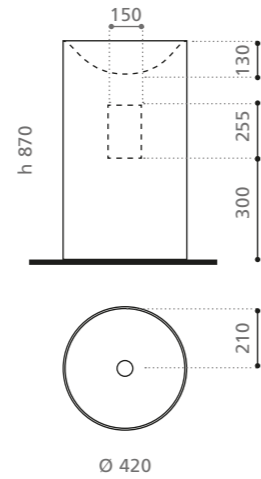

Ø foro / hole = 45 mm
peso / weight = 26,30 kg



MINI bathtub

Bi-mat

design by:
MARCO PISATI

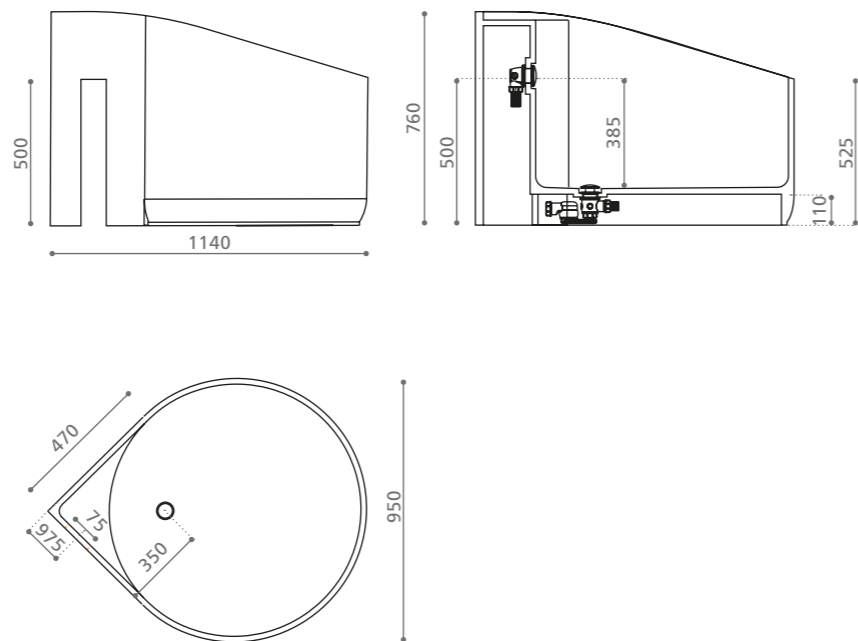

capacità acqua = 230 Lt. circa
water capacity = 230 Lt. approx.
peso / weight = 33,00 kg



RACCORDO free standing

per FLOWER Evolution e TOM TOM 2
Freestanding waste joint for Flower Evolution and TomTom2

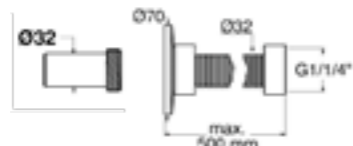

Tubo corrugato d.32 mm per raccordo a piletta (l.500mm, uscita attacco 32mm)
Flexible pipe d.32 mm for waste joint on freestanding washbasin



chrome
SCCR-RACC.DM32L50

Scarico per vasca

Bathtub waste with overflow

Scarico con troppo pieno per vasca e piletta Up & Down
Polypropylene pop up bathtub waste. Up & down mechanism

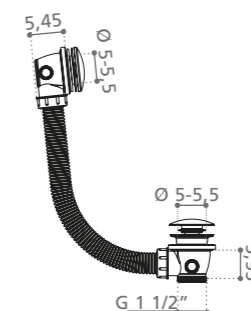

chrome
SCBTCR





IN-OUT SOLUTIONS



La scoperta dell'eleganza nascosta. *The discovery of hidden elegance.*

Il programma IN-OUT rappresenta collezioni di lavabi integrati, giocando con soluzioni cromatiche, stilistiche e dinamiche, che diventano espressione di sensazioni, colori ed emozioni. *The In-Out series is represented by a full range of integrated washbasins, playing with stylish and chromatic solutions, expressing feelings, colours and emotions.*

Kool
XL FL

VetroFreddo®



Lavabo in **VetroFreddo®**, foglia oro / washbasin **VetroFreddo®** gold leaf: code **KOOLXLFLFO**

Top in legno MDF bianco lucido / top white gloss in MDF wood: code **SIN100L0101**

Elemento in legno MDF con cassetto bianco lucido. Apertura push & pull / Furniture element with drawer white gloss in MDF wood. Push & pull opening: code **SINCA100L01**



Lavabo in **VetroFreddo®** nero opaco / washbasin **VetroFreddo®** black mat: code **KOOLXLFLPO30**

Top in legno MDF nero lucido / top black gloss in MDF wood: code **SIN100L3001**

Elemento in legno MDF con cassetto nero lucido. Apertura push & pull / furniture element with drawer black gloss in MDF wood. Push & pull opening: code **SINCA100L30**

Circus
43 FL

TeknoForm®

DV 54

55 DV

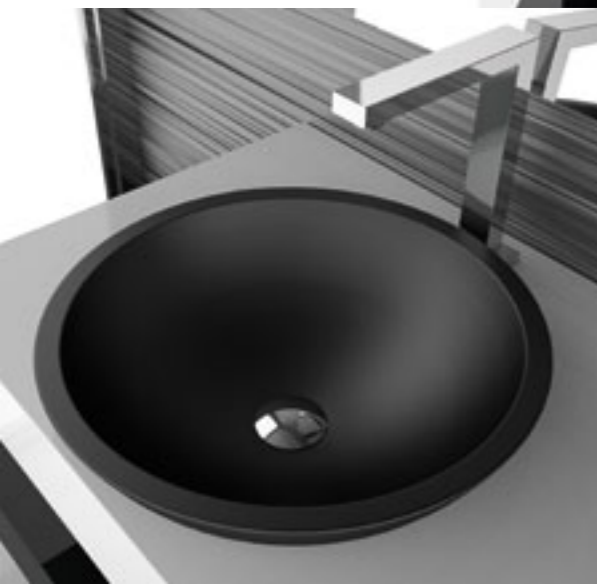

Lavabo in TeknoForm® bianco opaco / washbasin TeknoForm® white mat: code **CIRCUS43FLPO01**
Top in legno MDF nero lucido/top black gloss in MDF wood: code **SIN80L3002**
Elemento in legno MDF con cassetto nero lucido. Apertura push & pull/furniture element with drawer black gloss in MDF wood. Push & pull opening: code **SINCA120L30**

IN-OUT

Solutions

Circus
50 FL

TeknoForm®



DV 56

Lavabo in TeknoForm® foglia argento / washbasin TeknoForm® silver leaf: code **CIRCUS50FLFA**

Top in legno MDF nero lucido / top black gloss in MDF wood: code **SIN100L3003**

Elemento in legno MDF con cassetto nero lucido. Apertura push & pull / furniture element with drawer black gloss in MDF wood. Push & pull opening: code **SINCA80L30**



DV 57

Lavabo in TeknoForm® bianco opaco / washbasin TeknoForm® white mat: code **CIRCUS50FLPO01**

Top in legno MDF nero lucido / top black gloss in MDF wood: code **SIN100L3003**

Elemento in legno MDF con cassetto nero lucido. Apertura push & pull / furniture element with drawer black gloss in MDF wood. Push & pull opening: code **SINCA80L30**

Open

Pert®

DV 58



Lavabo in *Pert* nero lucido / washbasin *Pert* black gloss: code **OPEN402**
Top in legno MDF nero lucido/top black gloss in MDF wood: code **SIN120L3004**



59 DV

Lavabo in *Pert* foglia oro / washbasin *Pert* gold leaf: code **OPENFO**
Top in legno MDF bianco lucido / top white gloss in MDF wood: code **SIN120L0104**
Elemento in legno MDF con cassetto foglia oro. Apertura push & pull / furniture element with drawer gold leaf in MDF wood.
Push & pull opening: code **SINCA120FO**

Italy
FL

VetroFreddo®

DV 60



Lavabo in **VetroFreddo®** nero opaco / washbasin **VetroFreddo®** black mat: code **ITALYFLPO303F**

Top in legno MDF bianco lucido / top white gloss in MDF wood: code **SIN120L0105**

Elemento in legno MDF con cassetto bianco lucido. Apertura push & pull / furniture element with drawer white gloss in MDF wood. Push & pull opening: code **SINCA100L01**

61 DV



Lavabo in **VetroFreddo®** bianco opaco / washbasin **VetroFreddo®** white mat: code **ITALYFLPO013F**

Top in legno MDF nero lucido / top black gloss in MDF wood: code **SIN120L3005**

Elemento in legno MDF con cassetto nero lucido. Apertura push & pull / furniture element with drawer black gloss in MDF wood. Push & pull opening: code **SINCA100L30**

Riv
FL

VetroFreddo®

DV 62

63 DV

Lavabo in **VetroFreddo** nero opaco / washbasin **VetroFreddo** black mat: code **RIVFLPO303F**
Top in legno MDF bianco lucido / top white gloss in MDF wood: code **SIN100L0106**
Elemento in legno MDF con cassetto bianco lucido. Apertura push & pull / furniture element with drawer white gloss in MDF wood. Push & pull opening: code **SINCA80L01**

IN-OUT

Solutions

Kosta I

VetroFreddo®

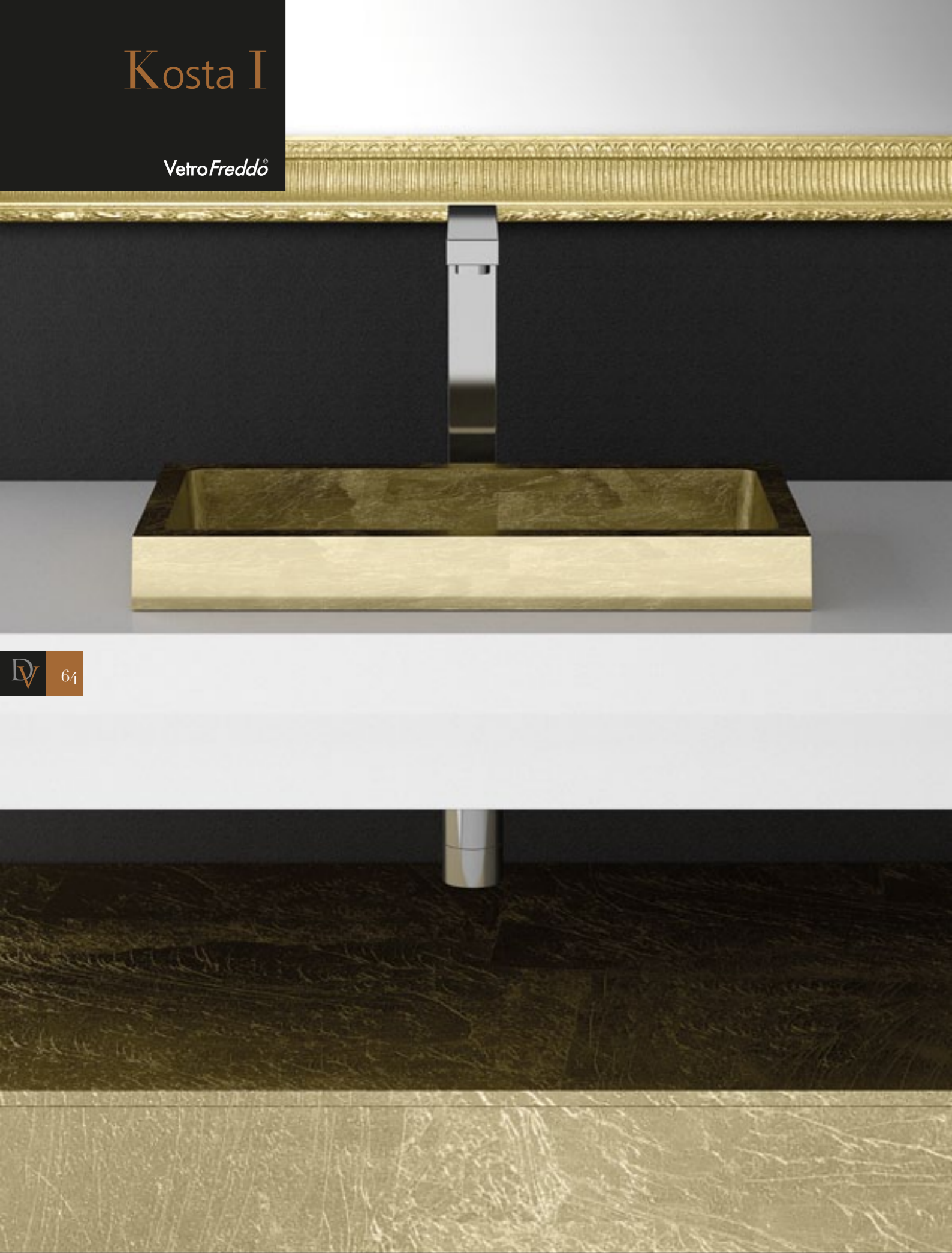

DV 64

Lavabo in **VetroFreddo** foglia oro / washbasin **VetroFreddo** gold leaf: code **KOSTA1FO**
Top in legno MDF bianco lucido / top white gloss in MDF wood: code **SIN100L0107**
Elemento in legno MDF con cassetto foglia oro. Apertura push & pull / furniture element with drawer gold leaf in MDF wood. Push & pull opening: code **SINCA100FO**



65 DV

Lavabo in **VetroFreddo** bianco opaco / washbasin **VetroFreddo** white mat: code **KOSTA1PO01**
Top in legno MDF nero lucido / top black gloss in MDF wood: code **SIN100L3007**
Elemento in legno MDF con cassetto bianco lucido. Apertura push & pull / furniture element with drawer white gloss in MDF wood. Push & pull opening: code **SINCA100L01**

Kosta II

VetroFreddo®

DV 66



Lavabo in VetroFreddo® foglia oro / washbasin VetroFreddo® gold leaf: code **KOSTA2FO**
Top in legno MDF bianco lucido / top white gloss in MDF wood: code **SIN120L0108**

Elemento in legno MDF con cassetto bianco lucido. Apertura push & pull / furniture element with drawer white gloss in MDF wood.
Push & pull opening: code **SINCA80L01**



67 DV

Lavabo in VetroFreddo® nero opaco / washbasin VetroFreddo® black mat: code **KOSTA2PO30**
Top in legno MDF bianco lucido / top white gloss in MDF wood: code **SIN100L0108**

Rx

VetroFreddo®



DV 68

69 DV

Lavabo in **VetroFreddo** bianco opaco / Washbasin **VetroFreddo** white mat: code **RXPO01**
Doppio Top in legno MDF nero lucido / Double top black gloss in MDF wood: code **SIN100L3009**
Elemento in legno MDF con cassetto nero lucido. Apertura push & pull / furniture element with drawer black gloss in MDF wood. Push & pull opening:
code **SINCA80L30**

VOLcano
FL

VetroFreddo®

DV 70

71 DV

Lavabo in VetroFreddo® nero opaco / Washbasin VetroFreddo® black mat: code **VOLCANOFLPO30**
Doppio Top in legno MDF bianco lucido / Double top white gloss in MDF wood: code **SIN80L0110**
Elemento in legno MDF con cassetto bianco lucido. Apertura push & pull / furniture element with drawer white gloss in MDF wood. Push & pull opening: code **SINCA80L01**

IN-OUT

Solutions

Jimmy
FL

VetroFreddo®

DV 72

73 DV

Lavabo in VetroFreddo® foglia argento / Washbasin VetroFreddo® silver leaf: code JIMMYFLFA
Doppio Top in legno MDF bianco lucido / Double top white gloss in MDF wood: code SIN120L0111
Doppio elemento in legno MDF con cassetto foglia argento. Apertura push & pull / Double furniture element with drawer silver leaf in MDF wood. Push & pull opening: code SINCA120FA

Jimmy In

VetroFreddo®

DV 74



Vasca integrata in VetroFreddo® bianco opaco / integrated washbasin VetroFreddo® white mat: code **JMI510C1020PO01**
Top in legno MDF nero lucido / top black gloss in MDF wood: code **SIN100L3012**
Elemento in legno MDF con cassetto nero lucido. Apertura push & pull / furniture element with drawer black gloss in MDF wood. Push & pull opening: code **SINCA80L30**

75 DV



Vasca integrata in VetroFreddo® bianco opaco / integrated washbasin VetroFreddo® white mat: code **JMI510C1020PO01**
Top in legno MDF beige lucido / Top in gloss beige MDF wood: code **SIN100L2012**
Elemento in legno MDF con cassetto beige lucido. Apertura push & pull / furniture element with drawer in gloss beige MDF wood. Push & pull opening: code **SINCA80L20**
Colonna sospesa reversibile in legno MDF beige lucido / Suspended reversible tall cabinet in gloss beige MDF wood: Sintesi code **SINCOL20**

IN-OUT

Solutions

Ellisse

FL

small - large - xl

VetroFreddo®

DV 76

77 DV

Lavabo in **VetroFreddo** nero opaco / Washbasin **VetroFreddo** black mat: code **ELLISSEXFLPO30**
Top in legno MDF bianco lucido / top white gloss in MDF wood: code **SIN80L0115**
Elemento centrale in legno MDF con cassetto nero lucido. Apertura push & pull / central furniture element with drawer black gloss in MDF wood. Push & pull opening: code **SINCA80L30**
Specchio tondo nero lucido / Round mirror black gloss Ø70 cm: code **FLOMIRRONL**
Accessori serie Kleiss **VetroFreddo** nero / Accessories Kleiss set **VetroFreddo** black: code **KLSETPO30**

IN-OUT

Solutions

Tondo
FL

VetroFreddo®



DV 78

Lavabo in **VetroFreddo** foglia oro / washbasin **VetroFreddo** gold leaf: code **TONDOFLFO**

Top in legno MDF bianco lucido / top white gloss in MDF wood: code **SIN80L0116**

Elemento in legno MDF con cassetto bianco lucido. Apertura push & pull / furniture element with drawer white gloss in MDF wood. Push & pull opening: code **SINCA80L01**

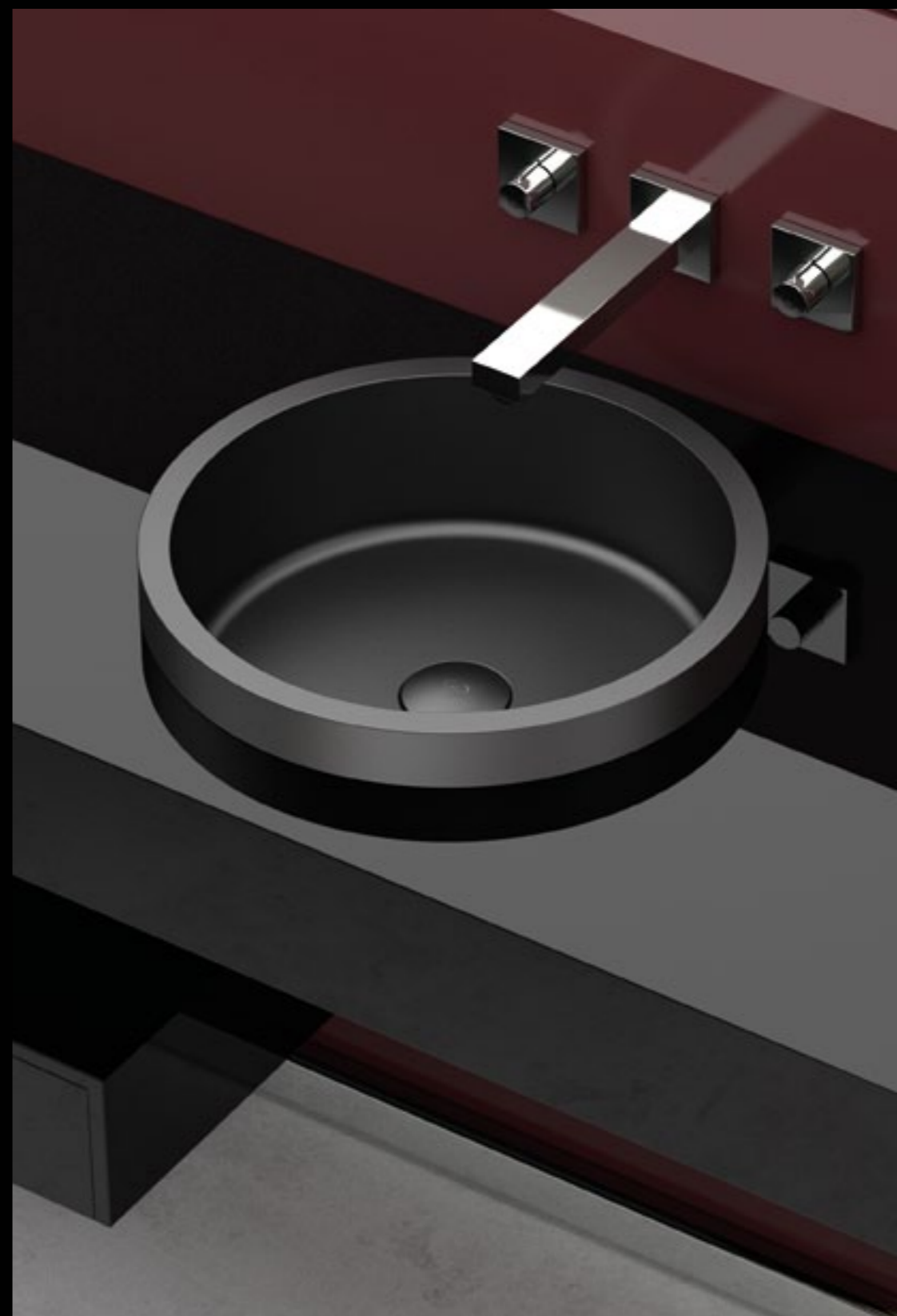

DV 79

Lavabo in **VetroFreddo** nero opaco / washbasin **VetroFreddo** black mat: code **TONDOFLPO30**

Top in legno MDF nero lucido / top black gloss in MDF wood: code **SIN100L3016**

Elemento in legno MDF con cassetto nero lucido. Apertura push & pull / furniture element with drawer black gloss in MDF wood. Push & pull opening: code **SINCA80L30**

Naxos
FL

VetroFreddo®

DV 80

81 DV

Lavabo in VetroFreddo® bianco opaco / Washbasin VetroFreddo® white mat: code **NAXOSFLPO01**
Top in legno MDF nero lucido / top black gloss in MDF wood: code **SIN80L3017**
Elemento centrale in legno MDF con cassetto bianco lucido. Apertura push & pull / central furniture element with drawer white gloss in MDF wood.
Push & pull opening: code **SINCA100L01**

IN-OUT

Solutions

“specifiche”
data sheet



Kool XL FL

brevettato / patented

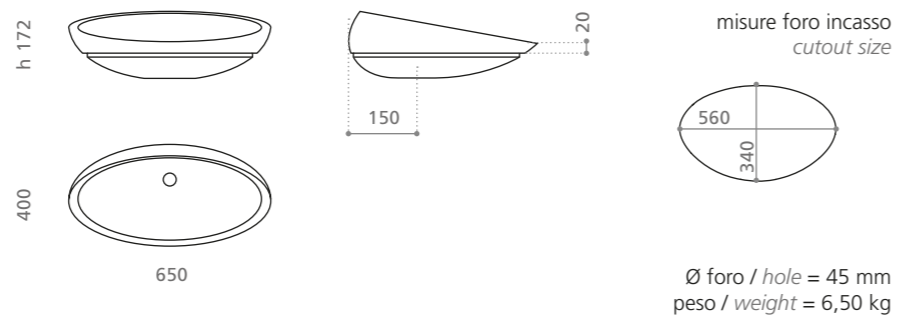

code:



white mat
KOOLXLFLPO01



black mat
KOOLXLFLPO30



gold leaf 3d
KOOLXLFLFO



silver leaf 3d
KOOLXLFLFA

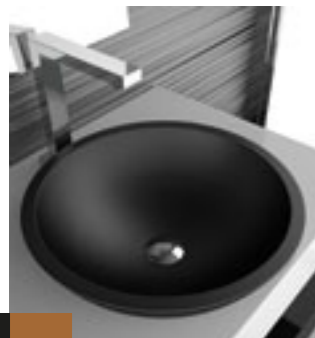

Circus 43 FL



code:



white mat
CIRCUS43FLPO01



black mat
CIRCUS43FLPO30



gold leaf 3d
CIRCUS43FLFO



silver leaf 3d
CIRCUS43FLFA

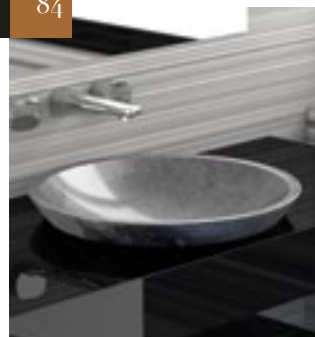

Circus 50 FL



code:



white mat
CIRCUS50FLPO01



black mat
CIRCUS50FLPO30



gold leaf 3d
CIRCUS50FLFO



silver leaf 3d
CIRCUS50FLFA



Open

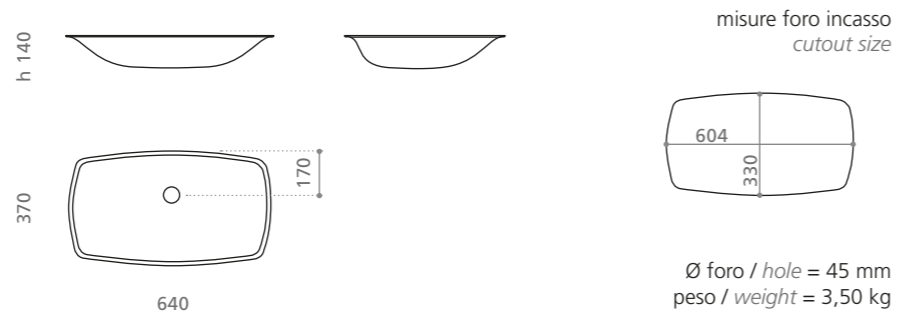

code:



white gloss
OPEN401



black gloss
OPEN402



gold leaf 3d
OPENFO



silver leaf 3d
OPENFA



Italy FL

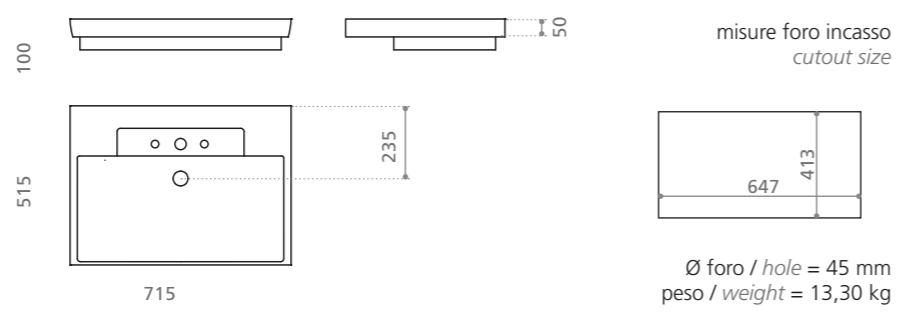

code:



white mat - 1 hole
ITFLPO01M



black mat - 1 hole
ITFLPO30M



white mat - 3 holes
ITFLPO013F



black mat - 3 holes
ITFLPO303F

1 foro per rubinetto / 1 hole for tap

3 fori per rubinetto / 3 holes for tap



Riv FL

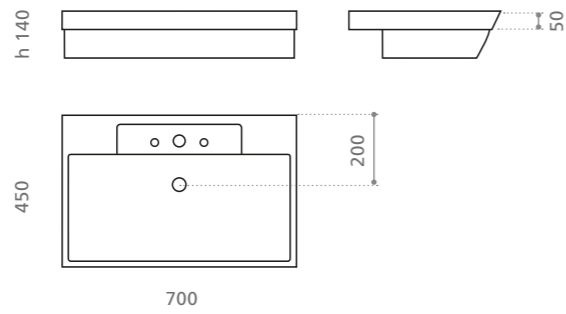

misure foro incasso
cutout size

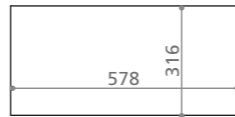

Ø foro / hole = 45 mm
peso / weight = 18,00 kg

code:



white mat - 1 hole
RVFLPO01M



black mat - 1 hole
RVFLPO30M



white mat - 3 holes
RVFLPO13F



black mat - 3 holes
RVFLPO30F

1 foro per rubinetto/1 hole for tap

3 fori per rubinetto/3 holes for tap



Kosta I

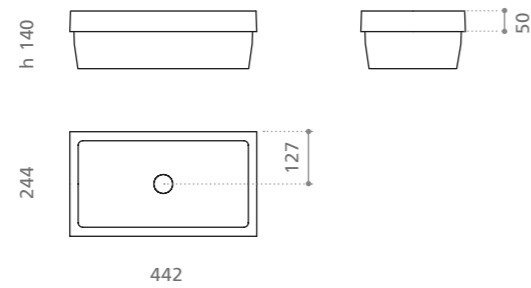

misure foro incasso
cutout size

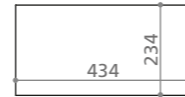

Ø foro / hole = 45 mm
peso / weight = 5,50 kg

code:



white mat
KOSTA1PO01



black mat
KOSTA1PO30



gold leaf 3d
KOSTA1FO

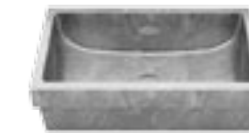

silver leaf 3d
KOSTA1FA

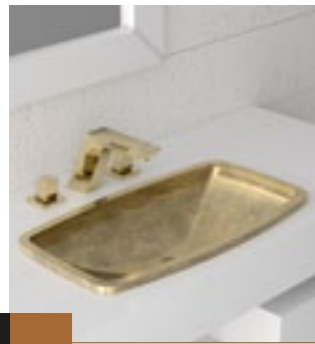

Kosta II

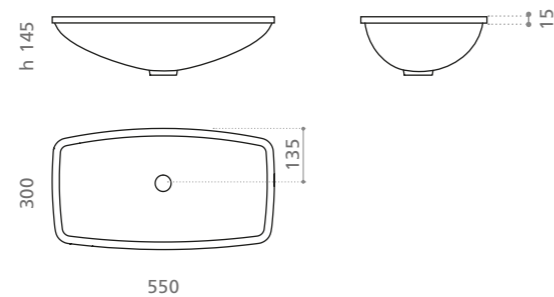

misure foro incasso
cutout size

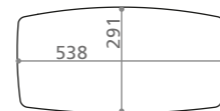

Ø foro / hole = 45 mm
peso / weight = 5,80 kg

code:



white mat
KOSTA2PO01



black mat
KOSTA2PO30



gold leaf 3d
KOSTA2FO



silver leaf 3d
KOSTA2FA

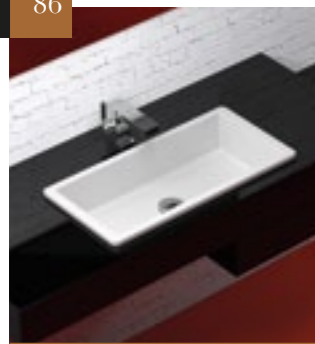

Rx

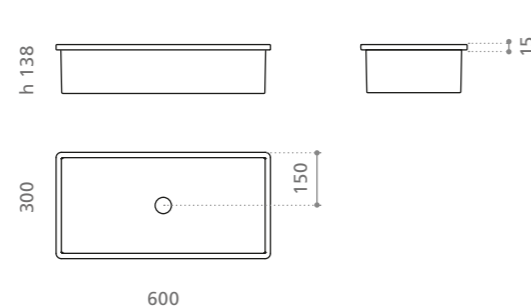

misure foro incasso
cutout size

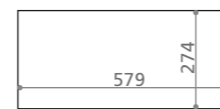

Ø foro / hole = 45 mm
peso / weight = 7,70 kg

code:



white mat
RXPO01



black mat
RXPO30



gold leaf 3d
RXFO



silver leaf 3d
RXFA



VOLcano
FL

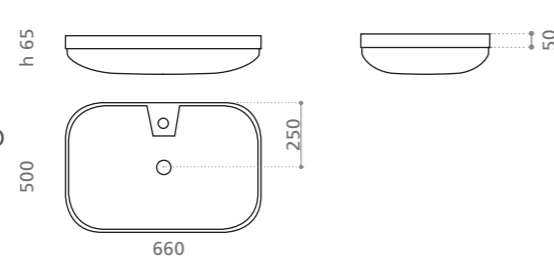

misure foro incasso
cutout size

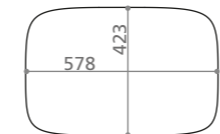

Ø foro / hole = 45 mm
peso / weight = 11,00 kg

code:



white mat
VOLCANOFLPO01



black mat
VOLCANOFLPO30



Jimmy FL

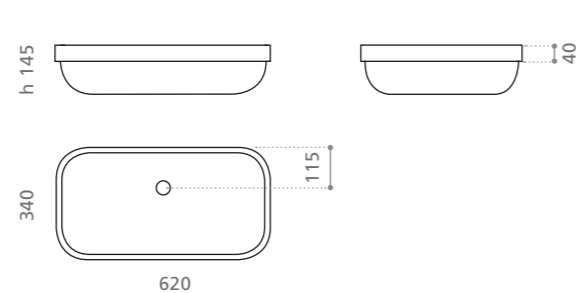

misure foro incasso
cutout size

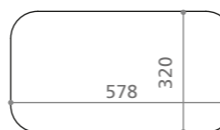

Ø foro / hole = 45 mm
peso / weight = 11,50 kg

code:



white mat
JIMMYFLPO01



black mat
JIMMYFLPO30



gold leaf 3d
JIMMYFLFO



silver leaf 3d
JIMMYFLFA

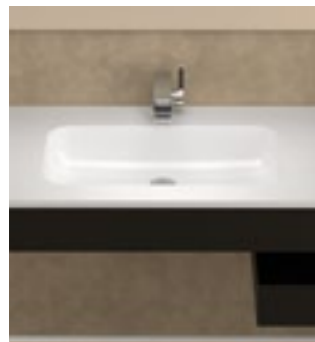

Jimmy In

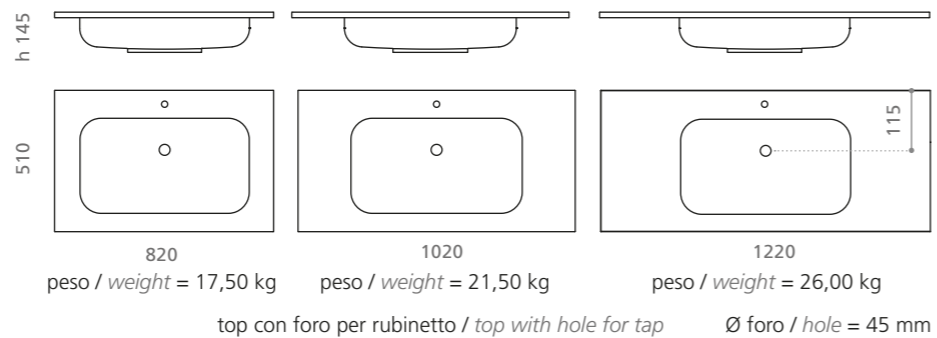

code:



white mat L 820
JMI510C820PO01



white mat L 1020
JMI510C1020PO01



white mat L 1220
JMI510C1220PO01



black mat L 820
JMI510C820PO30



black mat L 1020
JMI510C1020PO30



black mat L 1220
JMI510C1220PO30

code:



Ellisse FL
small

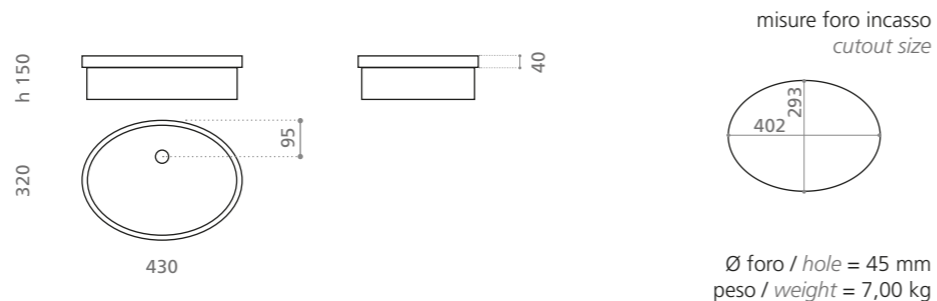

code:



white mat
ELLISSEFLPO01



black mat
ELLISSEFLPO30



gold leaf 3d
ELLISSEFLFO



silver leaf 3d
ELLISSEFLFA

Ellisse FL
large

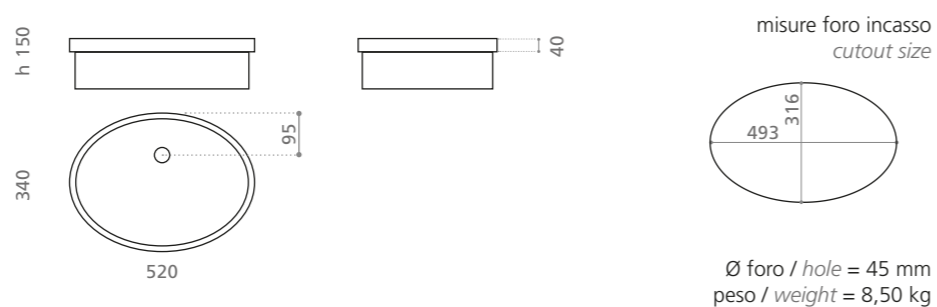

code:



white mat
ELLISSEFLPO01



black mat
ELLISSEFLPO30



gold leaf 3d
ELLISSEFLFO



silver leaf 3d
ELLISSEFLFA

Ellisse FL
xl

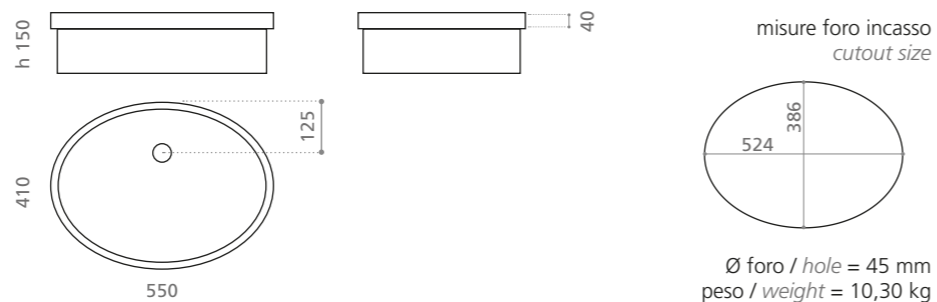

code:



white mat
ELLISSEXFLPO01



black mat
ELLISSEXFLPO30



gold leaf 3d
ELLISSEXFLFO

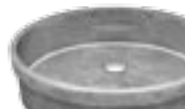

silver leaf 3d
ELLISSEXFLFA

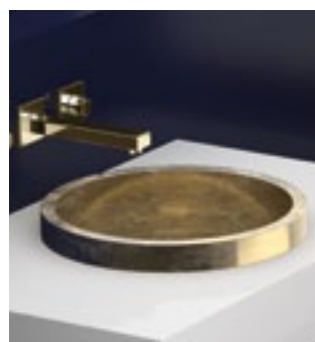

Tondo FL

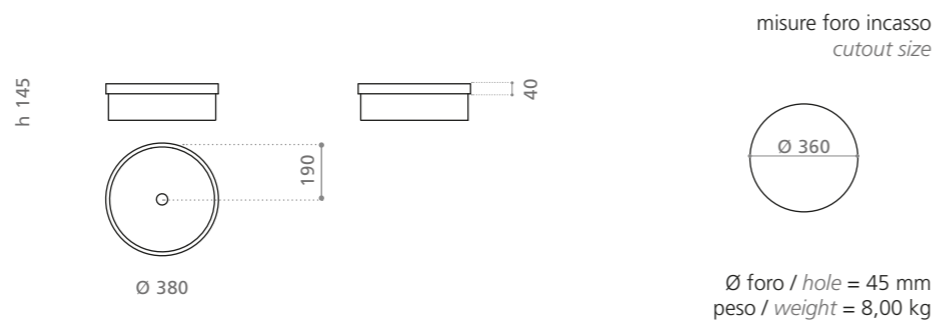

code:



white mat
TONDOFLPO01



black mat
TONDOFLPO30



gold leaf 3d
TONDOFLFO



silver leaf 3d
TONDOFLFA



Naxos FL

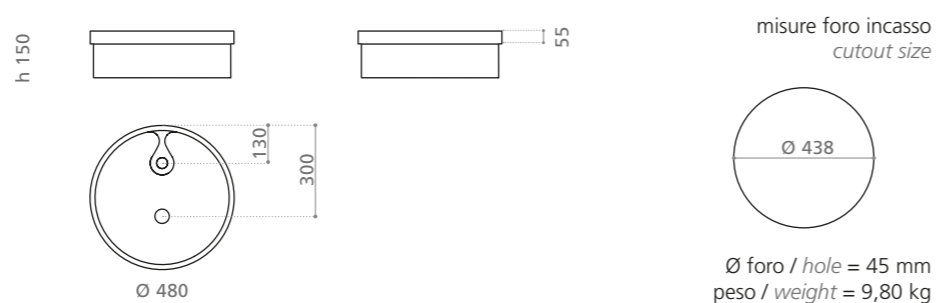

code:



white mat
NAXOSFLPO01



black mat
NAXOSFLPO30

Sintesi

Top porta-lavabo *Top for washbasin*



I top Glass Design sono stati studiati per attribuire semplice eleganza e una perfetta coordinabilità con tutta la gamma di lavabi, delle cassettiere e dei pensili.
Glass Design tops provide a simple elegance and are a perfect fit with the entire washbasin range, drawers and suspended tall cabinets.

I top realizzati in legno MDF vengono forniti con foro centrale per il corretto alloggiamento del lavabo scelto garantendo precisione e velocità di installazione.
Tops are supplied in MDF wood with a central cutout for the selected washbasin, allowing for easy installation.

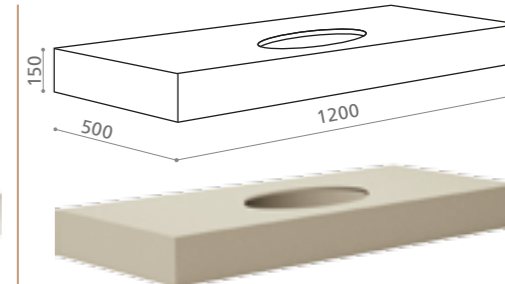
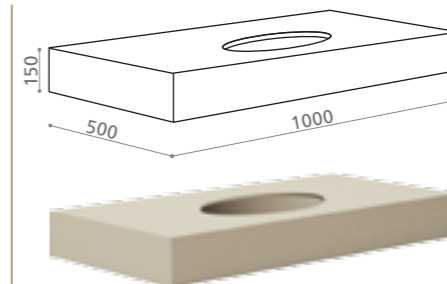
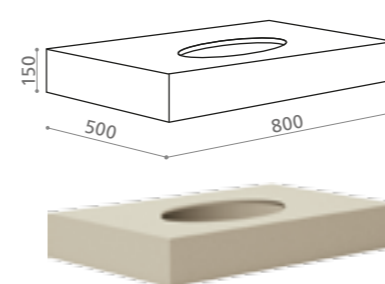

gloss beige code:

SIN80L2001	(for KOOL XL FL)*
SIN80L2002	(for CIRCUS43 FL)*
SIN80L2003	(for CIRCUS50 FL)
SIN80L2004	(for OPEN)*
SIN80L2005	(for ITALY FL)
SIN80L2006	(for RIV FL)
SIN80L2007	(for KOSTA I)*
SIN80L2008	(for KOSTA II)*
SIN80L2009	(for RX)*
SIN80L2010	(for VOLCANO FL)
SIN80L2011	(for JIMMY FL)*
SIN80L2012	(for JIMMY IN)
SIN80L2013	(for ELLISSE FL small)*
SIN80L2014	(for ELLISSE FL large)*
SIN80L2015	(for ELLISSE FL xl)*
SIN80L2016	(for TONDO FL)*
SIN80L2017	(for NAXOS FL)

SIN100L2001	(for KOOL XL FL)*
SIN100L2002	(for CIRCUS43 FL)*
SIN100L2003	(for CIRCUS50 FL)
SIN100L2004	(for OPEN)*
SIN100L2005	(for ITALY FL)
SIN100L2006	(for RIV FL)
SIN100L2007	(for KOSTA I)*
SIN100L2008	(for KOSTA II)*
SIN100L2009	(for RX)*
SIN100L2010	(for VOLCANO FL)
SIN100L2011	(for JIMMY FL)*
SIN100L2012	(for JIMMY IN)
SIN100L2013	(for ELLISSE FL small)*
SIN100L2014	(for ELLISSE FL large)*
SIN100L2015	(for ELLISSE FL xl)*
SIN100L2016	(for TONDO FL)*
SIN100L2017	(for NAXOS FL)

SIN120L2001	(for KOOL XL FL)*
SIN120L2002	(for CIRCUS43 FL)*
SIN120L2003	(for CIRCUS50 FL)
SIN120L2004	(for OPEN)*
SIN120L2005	(for ITALY FL)
SIN120L2006	(for RIV FL)
SIN120L2007	(for KOSTA I)*
SIN120L2008	(for KOSTA II)*
SIN120L2009	(for RX)*
SIN120L2010	(for VOLCANO FL)
SIN120L2011	(for JIMMY FL)*
SIN120L2012	(for JIMMY IN)
SIN120L2013	(for ELLISSE FL small)*
SIN120L2014	(for ELLISSE FL large)*
SIN120L2015	(for ELLISSE FL xl)*
SIN120L2016	(for TONDO FL)*
SIN120L2017	(for NAXOS FL)

(*) PER FORO RUBINETTO AGGIUNGERE AL CODICE DELL'ARTICOLO / FOR TAP HOLE PLEASE ADD TO PRODUCT CODE:

M = monoforo/1 hole | **3F** = 3 fori/3 holes

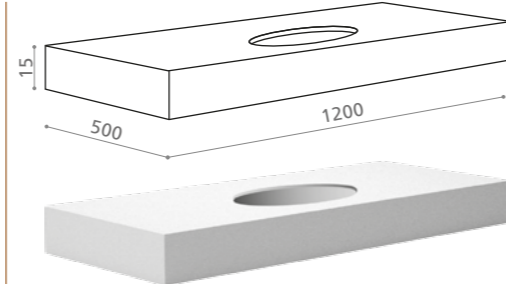
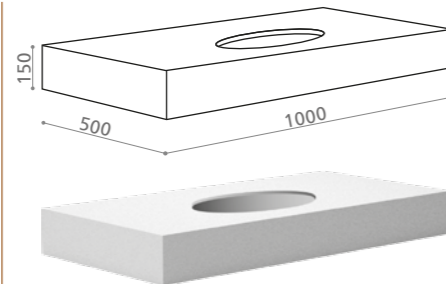
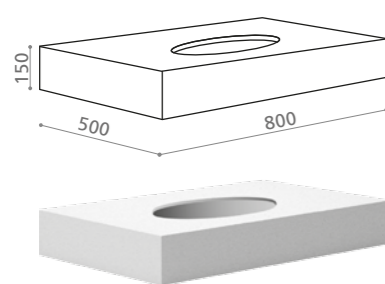

gloss white code:

SIN80L0101	(for KOOL XL FL)*
SIN80L0102	(for CIRCUS43 FL)*
SIN80L0103	(for CIRCUS50 FL)
SIN80L0104	(for OPEN)*
SIN80L0105	(for ITALY FL)
SIN80L0106	(for RIV FL)
SIN80L0107	(for KOSTA I)*
SIN80L0108	(for KOSTA II)*
SIN80L0109	(for RX)*
SIN80L0110	(for VOLCANO FL)
SIN80L0111	(for JIMMY FL)*
SIN80L0112	(for JIMMY IN)
SIN80L0113	(for ELLISSE FL small)*
SIN80L0114	(for ELLISSE FL large)*
SIN80L0115	(for ELLISSE FL xl)*
SIN80L0116	(for TONDO FL)*
SIN80L0117	(for NAXOS FL)

SIN100L0101	(for KOOL XL FL)*
SIN100L0102	(for CIRCUS43 FL)*
SIN100L0103	(for CIRCUS50 FL)
SIN100L0104	(for OPEN)*
SIN100L0105	(for ITALY FL)
SIN100L0106	(for RIV FL)
SIN100L0107	(for KOSTA I)*
SIN100L0108	(for KOSTA II)*
SIN100L0109	(for RX)*
SIN100L0110	(for VOLCANO FL)
SIN100L0111	(for JIMMY FL)*
SIN100L0112	(for JIMMY IN)
SIN100L0113	(for ELLISSE FL small)*
SIN100L0114	(for ELLISSE FL large)*
SIN100L0115	(for ELLISSE FL xl)*
SIN100L0116	(for TONDO FL)*
SIN100L0117	(for NAXOS FL)

SIN120L0101	(for KOOL XL FL)*
SIN120L0102	(for CIRCUS43 FL)*
SIN120L0103	(for CIRCUS50 FL)
SIN120L0104	(for OPEN)*
SIN120L0105	(for ITALY FL)
SIN120L0106	(for RIV FL)
SIN120L0107	(for KOSTA I)*
SIN120L0108	(for KOSTA II)*
SIN120L0109	(for RX)*
SIN120L0110	(for VOLCANO FL)
SIN120L0111	(for JIMMY FL)*
SIN120L0112	(for JIMMY IN)
SIN120L0113	(for ELLISSE FL small)*
SIN120L0114	(for ELLISSE FL large)*
SIN120L0115	(for ELLISSE FL xl)*
SIN120L0116	(for TONDO FL)*
SIN120L0117	(for NAXOS FL)

(*) PER FORO RUBINETTO AGGIUNGERE AL CODICE DELL'ARTICOLO / FOR TAP HOLE PLEASE ADD TO PRODUCT CODE:

M = monoforo/1 hole | **3F** = 3 fori/3 holes

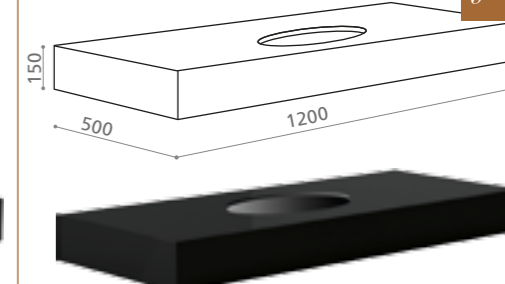
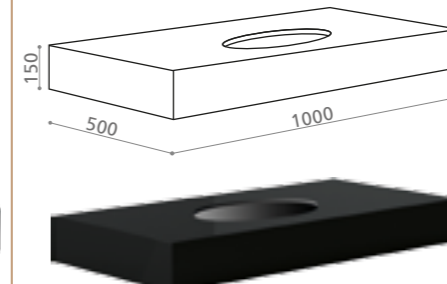
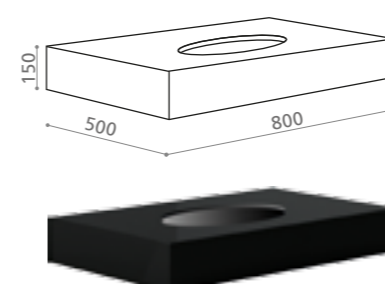

gloss black code:

SIN80L3001	(for KOOL XL FL)*
SIN80L3002	(for CIRCUS43 FL)*
SIN80L3003	(for CIRCUS50 FL)
SIN80L3004	(for OPEN)*
SIN80L3005	(for ITALY FL)
SIN80L3006	(for RIV FL)
SIN80L3007	(for KOSTA I)*
SIN80L3008	(for KOSTA II)*
SIN80L3009	(for RX)*
SIN80L3010	(for VOLCANO FL)
SIN80L3011	(for JIMMY FL)*
SIN80L3012	(for JIMMY IN)
SIN80L3013	(for ELLISSE FL small)*
SIN80L3014	(for ELLISSE FL large)*
SIN80L3015	(for ELLISSE FL xl)*
SIN80L3016	(for TONDO FL)*
SIN80L3017	(for NAXOS FL)

SIN100L3001	(for KOOL XL FL)*
SIN100L3002	(for CIRCUS43 FL)*
SIN100L3003	(for CIRCUS50 FL)
SIN100L3004	(for OPEN)*
SIN100L3005	(for ITALY FL)
SIN100L3006	(for RIV FL)
SIN100L3007	(for KOSTA I)*
SIN100L3008	(for KOSTA II)*
SIN100L3009	(for RX)*
SIN100L3010	(for VOLCANO FL)
SIN100L3011	(for JIMMY FL)*
SIN100L3012	(for JIMMY IN)
SIN100L3013	(for ELLISSE FL small)*
SIN100L3014	(for ELLISSE FL large)*
SIN100L3015	(for ELLISSE FL xl)*
SIN100L3016	(for TONDO FL)*
SIN100L3017	(for NAXOS FL)

SIN120L3001	(for KOOL XL FL)*
SIN120L3002	(for CIRCUS43 FL)*
SIN120L3003	(for CIRCUS50 FL)
SIN120L3004	(for OPEN)*
SIN120L3005	(for ITALY FL)
SIN120L3006	(for RIV FL)
SIN120L3007	(for KOSTA I)*
SIN120L3008	(for KOSTA II)*
SIN120L3009	(for RX)*
SIN120L3010	(for VOLCANO FL)
SIN120L3011	(for JIMMY FL)*
SIN120L3012	(for JIMMY IN)
SIN120L3013	(for ELLISSE FL small)*
SIN120L3014	(for ELLISSE FL large)*
SIN120L3015	(for ELLISSE FL xl)*
SIN120L3016	(for TONDO FL)*
SIN120L3017	(for NAXOS FL)

(*) PER FORO RUBINETTO AGGIUNGERE AL CODICE DELL'ARTICOLO / FOR TAP HOLE PLEASE ADD TO PRODUCT CODE:

M = monoforo/1 hole | **3F** = 3 fori/3 holes

Sintesi

Elemento con cassetto *Element with drawer*



I cassetti Glass Design realizzati in legno MDF sono perfettamente coordinabili con la gamma dei pensili e dei piani, creando molteplici combinazioni personalizzate. Sistema di apertura push & pull.

Glass Design drawers in MDF wood, elegantly match tops and suspended tall cabinets, giving life to a variety of custom solutions. Push & pull opening system.

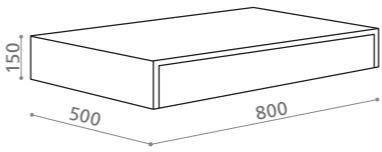
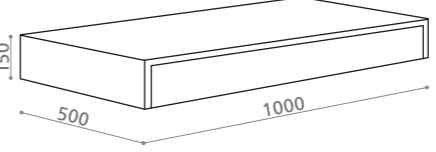
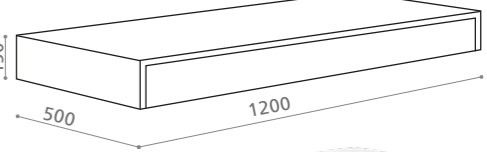
			
code:	<i>gloss white</i> SINCA80L01	<i>gloss white</i> SINCA100L01	<i>gloss white</i> SINCA120L01
code:	<i>gloss beige</i> SINCA80L20	<i>gloss beige</i> SINCA100L20	<i>gloss beige</i> SINCA120L20
code:	<i>gloss black</i> SINCA80L30	<i>gloss black</i> SINCA100L30	<i>gloss black</i> SINCA120L30
code:	<i>gold leaf 3D</i> SINCA80FO	<i>gold leaf 3D</i> SINCA100FO	<i>gold leaf 3D</i> SINCA120FO
code:	<i>silver leaf 3D</i> SINCA80FA	<i>silver leaf 3D</i> SINCA100FA	<i>silver leaf 3D</i> SINCA120FA

Sintesi

Colonna sospesa reversibile *Suspended reversible tall cabinet*

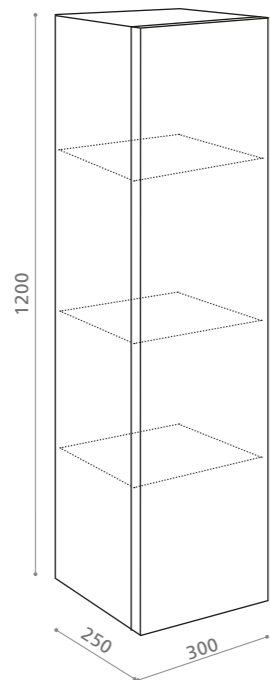

code:



gloss white
SINCO120L01



gloss beige
SINCO120L20



gloss black
SINCO120L30



gold leaf 3D
SINCO120FO



silver leaf 3D
SINCO120FA

“Sotto”

SISTEMA top in vetro “FULL COLOUR GLASS” con lavabo sottopiano
SYSTEM for “FULL COLOUR GLASS” top with undermounted washbasin

Blade

SOTTO

Pert®

DV 96



Lavabo da incasso in *Pert*® foglia oro. Disponibile su richiesta con foro troppo pieno / *undermounted washbasin Pert*® gold leaf. Available on demand with overflow hole: code **BLASFO**

Cover lavabo foglia oro / *washbasin cover gold leaf*: code **CRFO**

Top in vetro Full Colour Glass nero lucido / *Full Colour Glass top black gloss*: code **TOPG121NL**

Mobile in legno MDF nero lucido / *black gloss furniture in MDF wood*: cm code **SINN120**

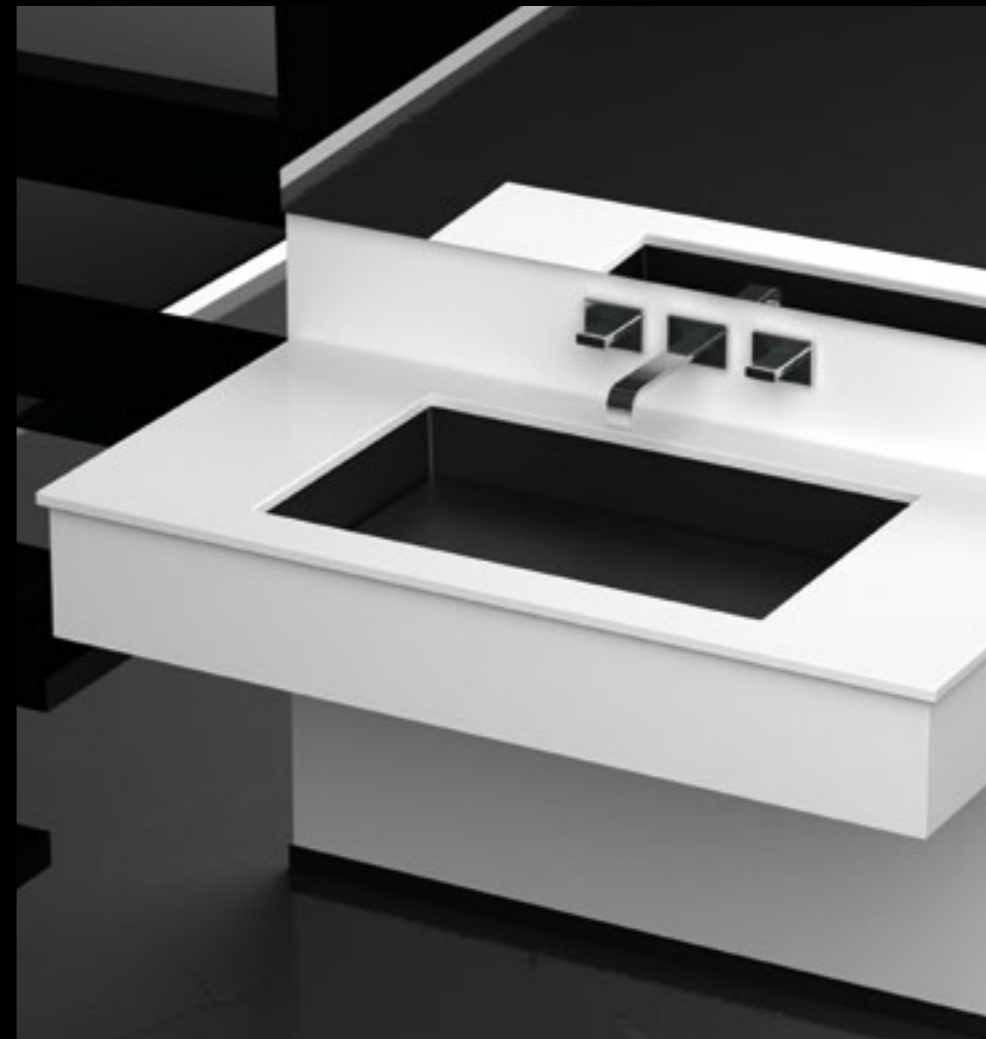

DV 97

Lavabo da incasso in *Pert*® nero opaco. Disponibile su richiesta con foro troppo pieno / *undermounted washbasin Pert*® black mat. Available on demand with overflow hole: code **BLASNO**

Cover lavabo nero opaco / *washbasin cover black mat*: code **CRNO**

Top in vetro Full Colour Glass bianco lucido / *Full Colour Glass top white gloss*: code **TOPG101BL**

Mobile in legno MDF bianco lucido / *white gloss furniture in MDF wood*: code **SINB100**

Four
SOTTO

Pert®

DV 98

99 DV

Lavabo da incasso in *Pert* bianco opaco con foro troppo pieno / *undermounted washbasin Pert* white mat with overflow hole: code **FOUSBOTP**
Cover lavabo nero opaco / *washbasin cover black mat*: code **CQNO**
Top in vetro Full Colour Glass nero lucido / *Full Colour Glass top black gloss*: code **TOPG101NL**
Mobile in legno MDF nero lucido / *black gloss furniture in MDF wood*: code **SINN100**

Lavabo da incasso in *Pert* nero opaco con foro troppo pieno / *undermounted washbasin Pert* black mat with overflow hole: code **FOUSNOTP**
Cover lavabo bianco opaco / *washbasin cover white mat*: code **CQBO**
Top in vetro Full Colour Glass bianco lucido / *Full Colour Glass top white gloss*: code **TOPG101BL**
Mobile in legno MDF bianco lucido / *white gloss furniture in MDF wood*: code **SINB100**

Rho
SOTTO

Pert®

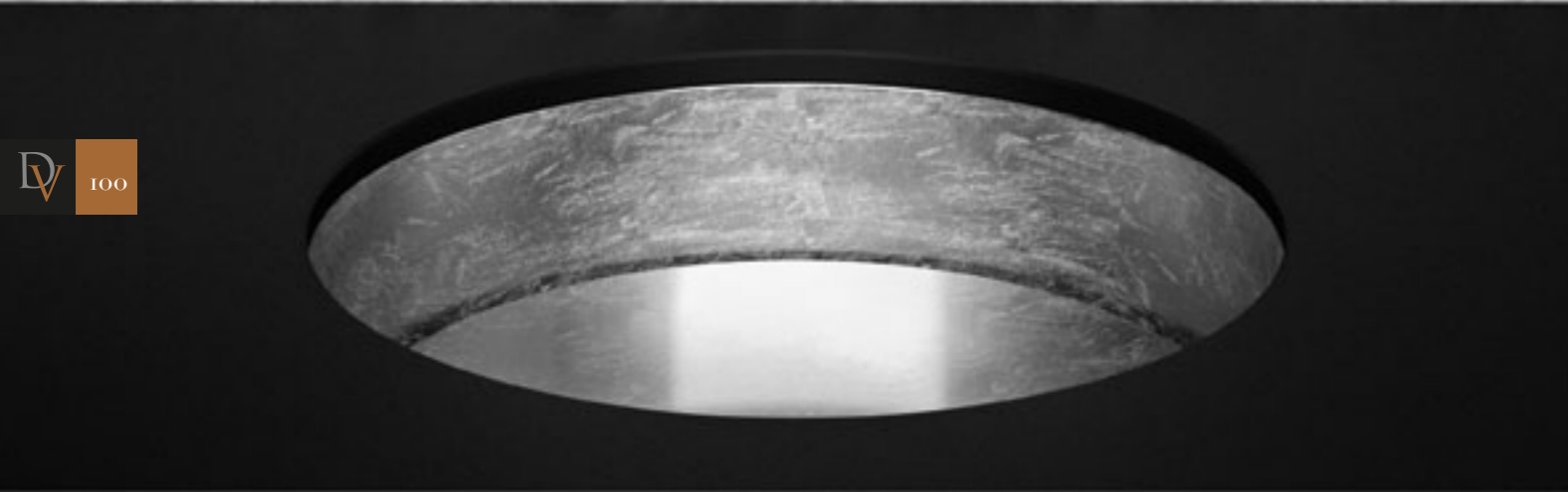

DV 100

Lavabo da incasso in *Pert®* foglia argento. Disponibile su richiesta con foro troppo pieno / *undermounted washbasin Pert® silver leaf. Available on demand with overflow hole: code RHOSFA*

Cover lavabo foglia argento / *washbasin cover silver leaf: code CTFA*

Top in vetro Full Colour Glass nero lucido / *Full Colour Glass top black gloss: code TOPG121NL*

Mobile in legno MDF nero lucido / *black gloss furniture in MDF wood: code SINN120*



101 DV

Lavabo da incasso in *Pert®* foglia oro. Disponibile su richiesta con foro troppo pieno / *undermounted washbasin Pert® gold leaf. Available on demand with overflow hole: code RHOSFO*

Cover lavabo foglia oro / *washbasin cover gold leaf: code CTFO*

Top in vetro Full Colour Glass bianco lucido / *Full Colour Glass top white gloss: code TOPG101BL*

Mobile in legno MDF bianco lucido / *white gloss furniture in MDF wood: code SINB100*

Elemento in legno MDF con cassetto foglia oro. Apertura push & pull / *Furniture element with drawer gold leaf in MDF wood. Push & pull opening: code SINCA100FO*

Flou
SOTTO

Florence Glass
ATELIER®

DV 102

103 DV

Lavabo da incasso in cristallo foglia oro con troppo pieno / *undermounted crystal washbasin gold leaf with overflow hole*: code **FLOUSFOTPG**

Top in vetro Full Colour Glass bianco opaco / *Full Colour Glass top white mat*: code **TOPG101BO**

Mobile in legno MDF bianco lucido / *white gloss furniture in MDF wood*: code **SINB100**

IN-OUT

Solutions

Bolla
SOTTO

Florence Glass
ATELIER®

DV 104

105 DV

Lavabo da incasso in cristallo nero lucido con troppo pieno / *undermounted crystal washbasin black gloss with overflow hole*: code **BOLSNLTPG**
Top in vetro Full Colour Glass nero opaco / *Full Colour Glass top black mat*: code **TOPG101NO**
Mobile in legno MDF nero lucido / *black gloss furniture in MDF wood*: code **SINN100**

IN-OUT

Solutions

Yacht
SOTTO

TeknoForm®

DV 106



107 DV

Lavabo da incasso in TeknoForm® bianco con troppo pieno integrato / *undermounted washbasin TeknoForm® white mat with integrated overflow:*
code **YACHTSBO**

Top in vetro Full Colour Glass nero opaco / *Full Colour Glass top black mat:* code **TOPG121NO**

Mobile in legno MDF nero lucido / *black gloss furniture in MDF wood:* code **SINN120**

IN-OUT

Solutions

Sotto

Top "FULL COLOUR GLASS" con lavabo sottopiano

I Top "Full Colour Glass" sono stati studiati per attribuire semplice eleganza e una perfetta coordinabilità con tutta la gamma delle cassettiere e dei pensili "Sintesi".

Eleganza e design, creativi e funzionali.

I top vengono forniti con foro centrale e lavabo già assemblato nelle finiture scelte garantendo precisione e velocità di installazione.

RIFLESSI PERFETTI E INALTERABILI.

Una nuova materia dalle caratteristiche uniche.

Ottenuto attraverso un procedimento di scioglimento e cristallizzazione di ceramiche e particelle di silicio, un processo molto simile alle condizioni naturali di formazione del granito. Il suo aspetto esteriore invece è molto simile al marmo, ma con caratteristiche di durezza, lucentezza, inassorbenza e resistenza nettamente superiori. Assolutamente omogeneo, inattaccabile da qualsiasi tipo di sostanza acida o alcalina.

La tecnologia e la duttilità di questo materiale consentono di progettare l'ambiente bagno realizzando qualsiasi tipo di misura per assecondare e soddisfare le richieste più esigenti.

- 1 Materiale ecologico per eccellenza, ricavato da elementi naturali, non presenta né resine né solventi.
- 2 Riciclabile al 100%
- 3 Inattaccabile dal calcare
- 4 Colore inalterabile, resistente anche ad esposizioni prolungate ai raggi UV.
- 5 Resistente a qualsiasi prodotto usato per la pulizia del bagno.
- 6 Facile da pulire.

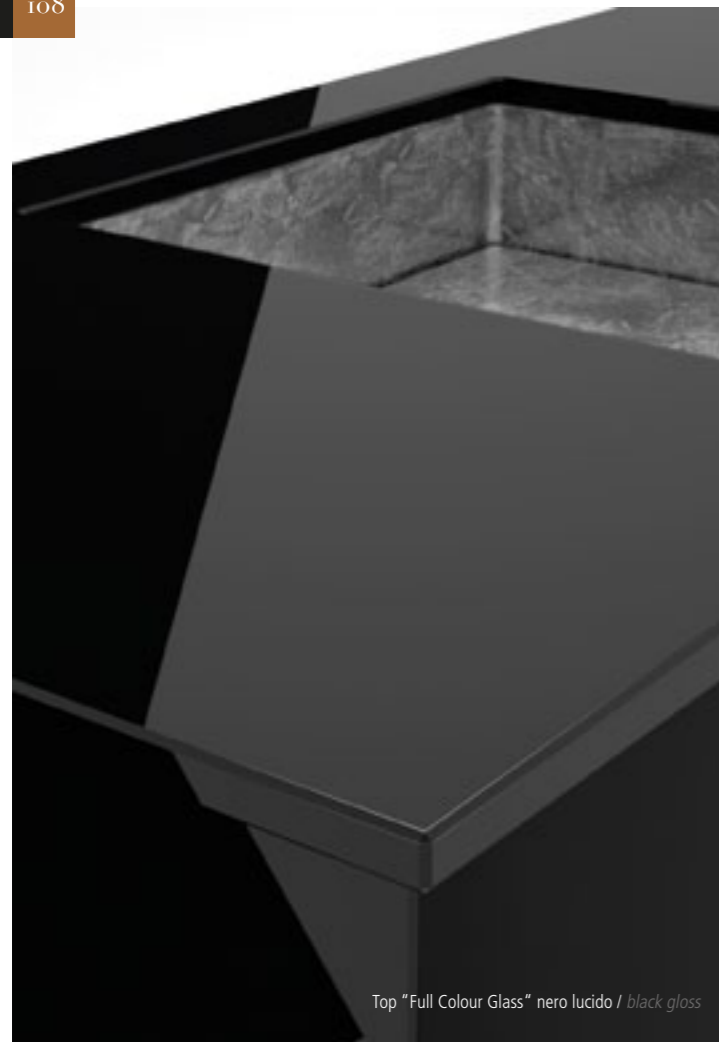

Top "Full Colour Glass" nero lucido / black gloss



Top "Full Colour Glass" nero opaco / black mat

Sotto

"FULL COLOUR GLASS" top with undermounted washbasin

The "Full Colour Glass" Tops are conceived to provide a simple elegance and a perfect fit with the entire drawers and suspended tall cabinets.

Elegance and design, creativity and functionality.

Tops are supplied with central hole and undermounted washbasin already assembled in the chosen finishes, allowing a perfect and easy installation.

PERFECT AND UNALTERABLE REFLECTIONS.

A new material with unique features.

It is obtained through a process of dissolution and crystallization of ceramics and silicon parts. The process is very similar to the natural characteristics of granite formation. Its feature is very similar to marble, but with advantages in terms of hardness, brightness and resistance.

It is homogeneous, durable, acid and alkaline proof.

The technology and the ductility of this material allow to design your bathroom in any customised dimensions in order to meet individual requirements.

1 Ecologic material par excellence, obtained from natural elements, free from resins and from solvents.

2 100% recyclable.

3 Not affected by limestone.

4 Durable colour, resistant to prolonged UV-rays exposition.

5 Resistant to any product used for bathroom cleaning.

6 Easy to clean.

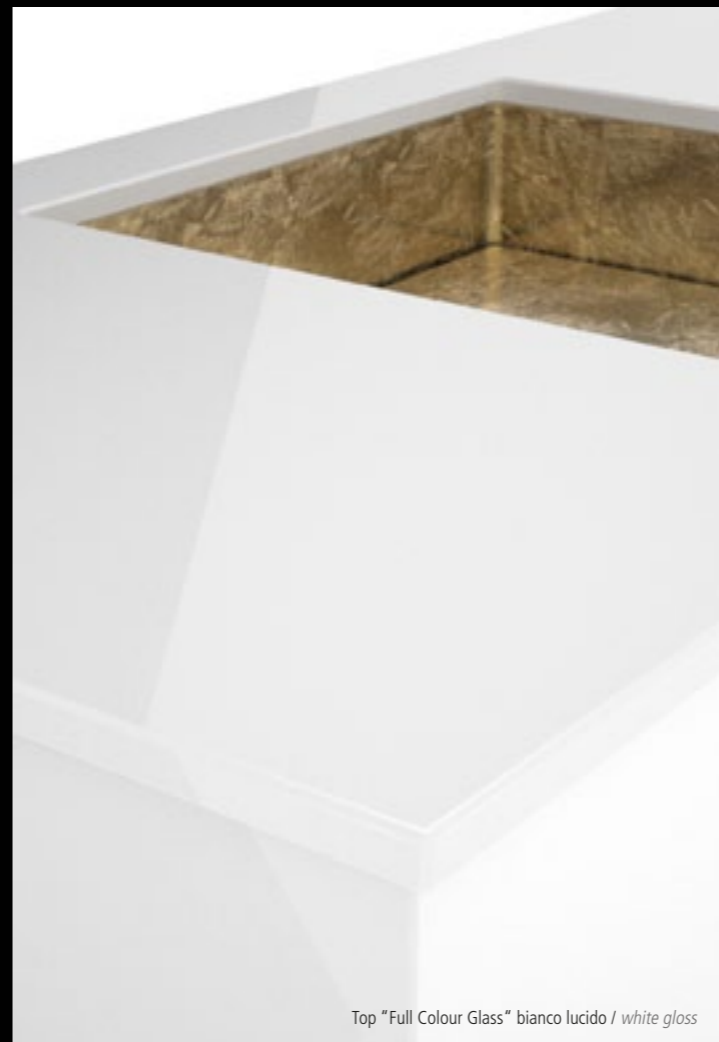

Top "Full Colour Glass" bianco lucido / white gloss



Top "Full Colour Glass" bianco opaco / white mat

Contemporary

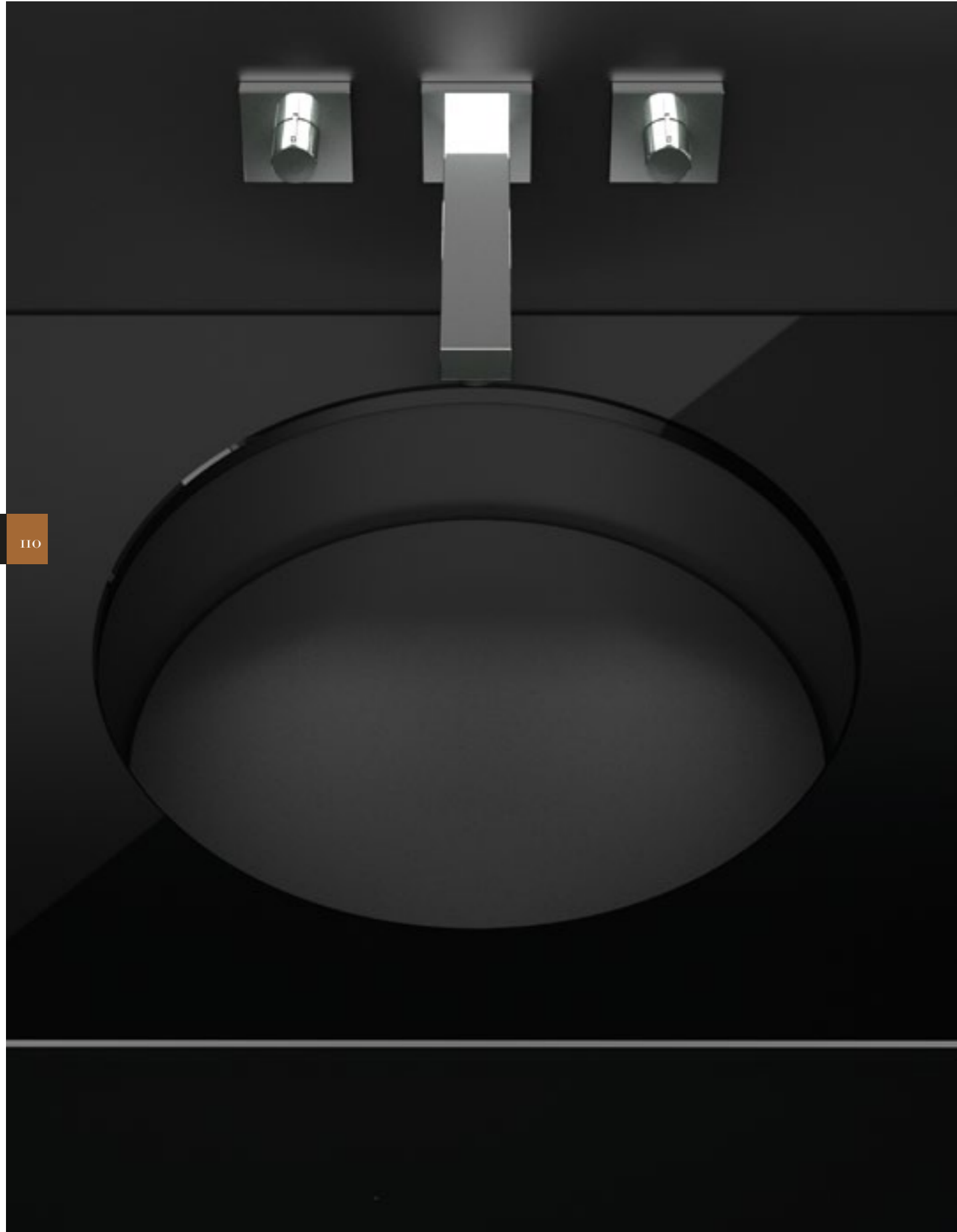

inspirations

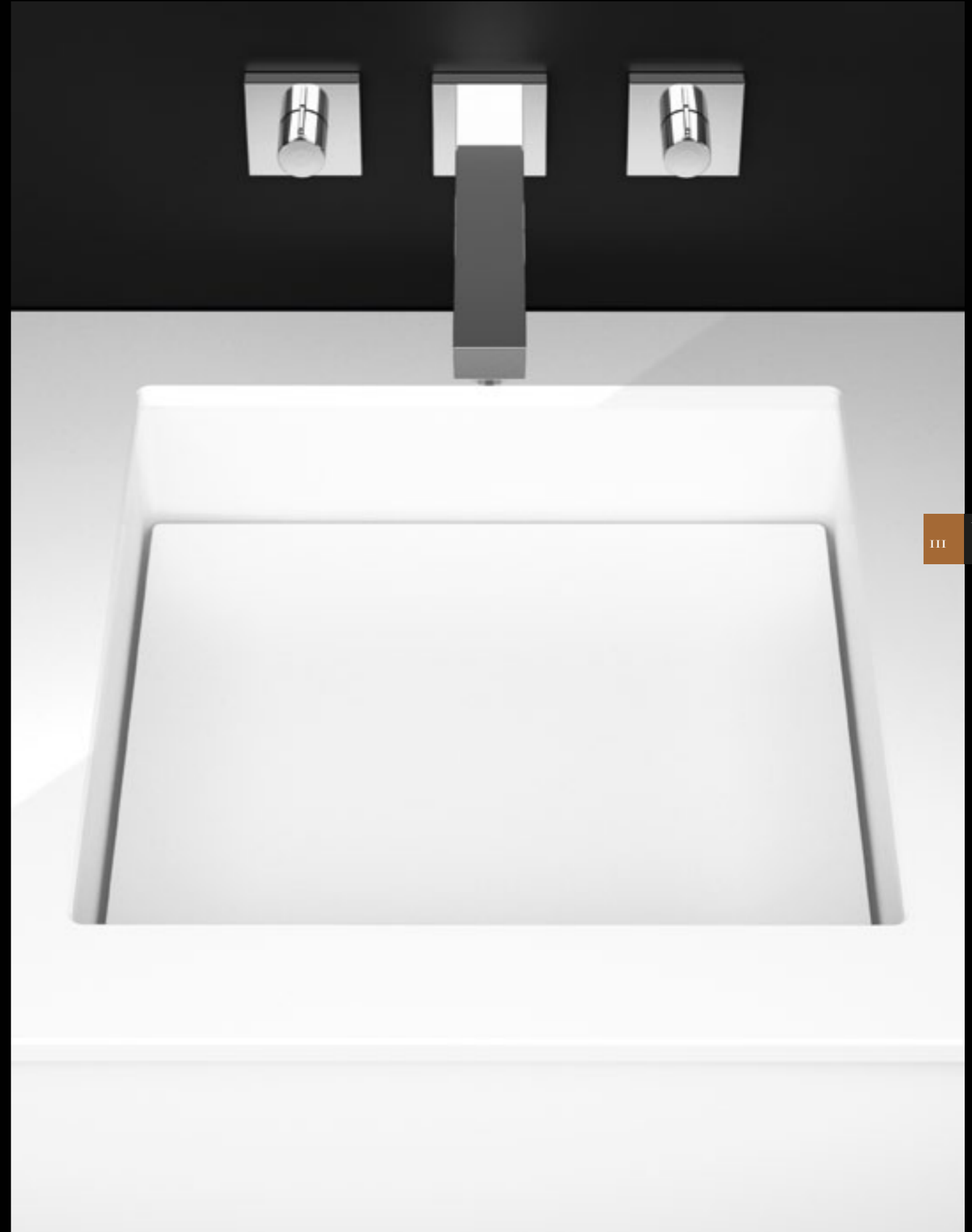

Fashion, Design,

Luxury ... inspirations

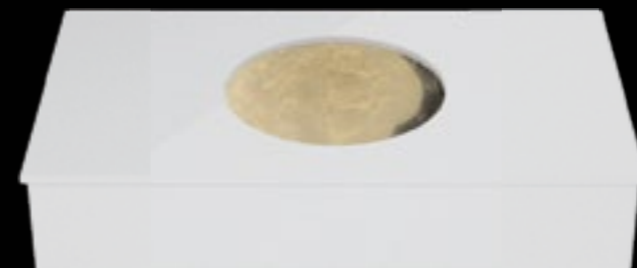
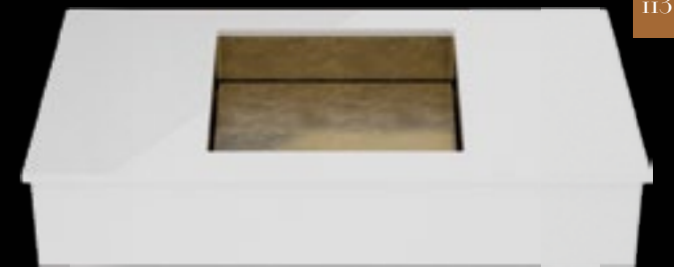

Personalizza

Il sistema "SOTTO" Glass Design amplia ulteriormente gli orizzonti della creatività col suo programma di personalizzazione raggiungendo misure e configurazioni estremamente libere.

Il programma prevede la configurazione con uno o più lavabi "SOTTO" quali Blade, Four, Rho, Flou, Bolla e Yacht.

Customise

The new Glass Design "SOTTO" system extends further the creativity with its custom-made program by reaching sizes and solutions "tailor made".

With this program we can combine one or more "Sotto" washbasins: Blade, Four, Rho, Flou, Bolla and Yacht.

Full Colour Glass Top dimensioni / sizes:

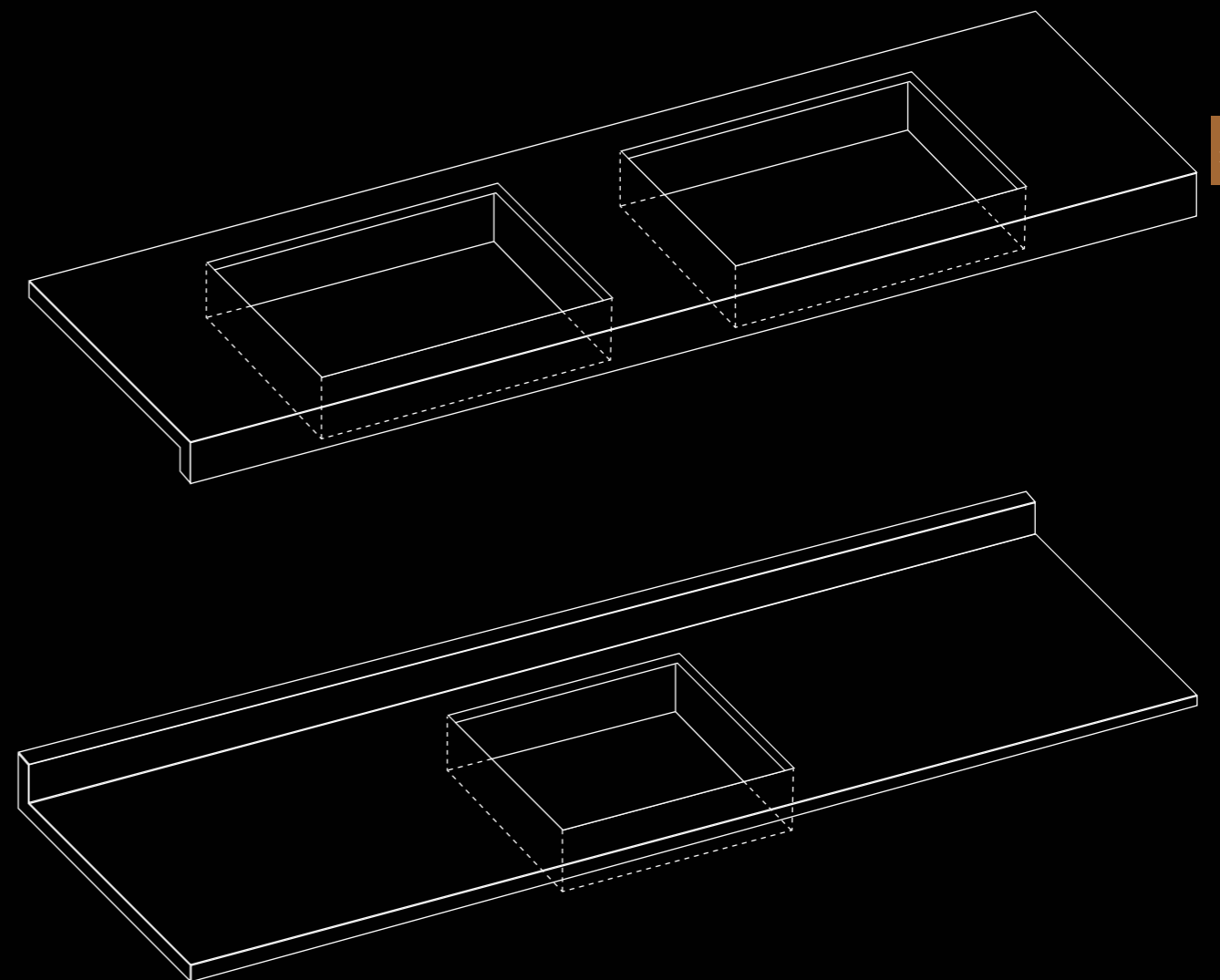
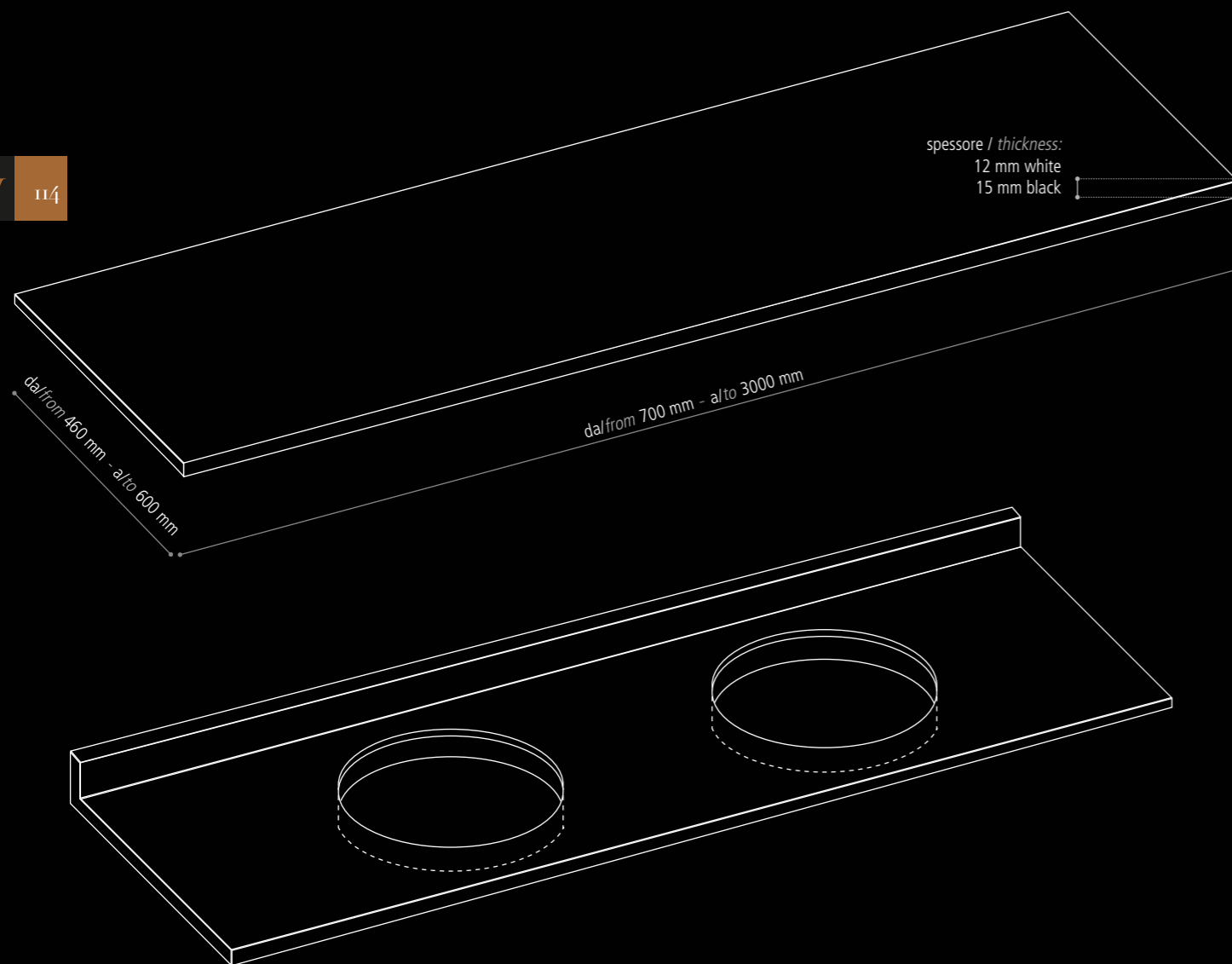

Blade SOTTO

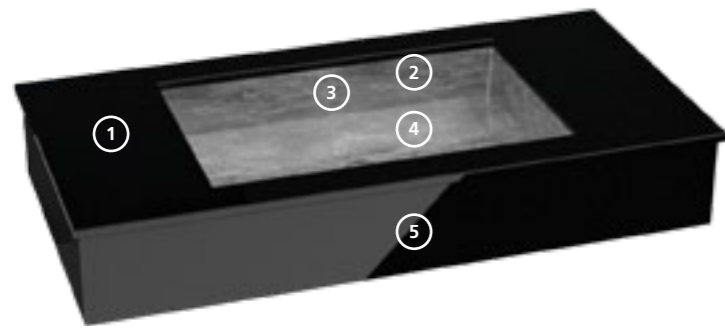

A Scegli la dimensione
Choose the size

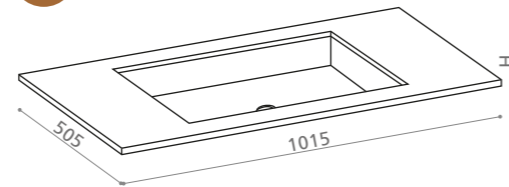

Blade sotto 1015
TOPG101

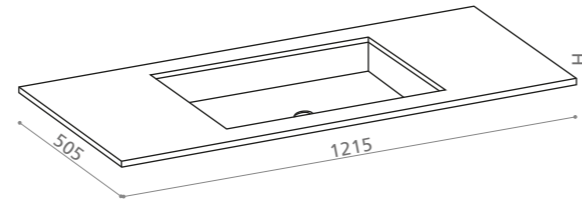

Blade sotto 1215
TOPG121

1

Scegli il colore del TOP in vetro
Choose the colour
Full Colour Glass Top

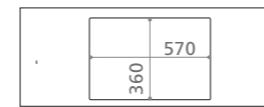

- bianco opaco/white mat
H 12mm code: BO
- bianco lucido/white gloss
H 12mm code: BL
- nero opaco/black mat
H 15mm code: NO
- nero lucido/black gloss
H 15mm code: NL

2

Scegli il colore del lavabo
Choose the washbasin colour
BLADE

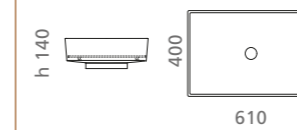

- foglia oro/gold leaf
code: BLASFO
- foglia argento/silver leaf
code: BLASFA
- bianco opaco/white mat
code: BLASBO
- nero opaco/black mat
code: BLASNO

3

Troppo pieno
Joint for overflow

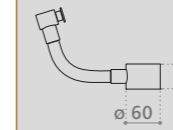

- oro/gold
code: TPG
- cromo/chrome
code: TP

4

Scegli il colore del carabotto
Choose the cover colour

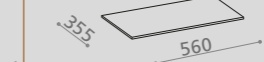

- foglia oro/gold leaf
code: CRFO
- foglia argento/silver leaf
code: CRFA
- bianco opaco/white mat
code: CRBO
- bianco lucido/white gloss
code: CRBL
- nero opaco/black mat
code: CRNO
- nero lucido/black gloss
code: CRNL

5

Scegli il colore e la misura del mobile.
(Comprensivo di attacchi a muro)
Choose colour and size for the
furniture.
(Wall fixing accessories included)

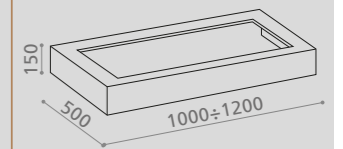

- bianco lucido 100/white gloss
code: SINB100
- bianco lucido 120/white gloss
code: SINB120
- nero lucido 100/black gloss
code: SINN100
- nero lucido 120/black gloss
code: SINN120

Four SOTTO

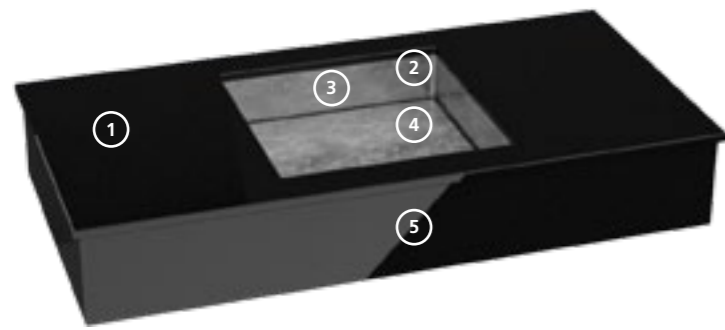

A Scegli la dimensione
Choose the size

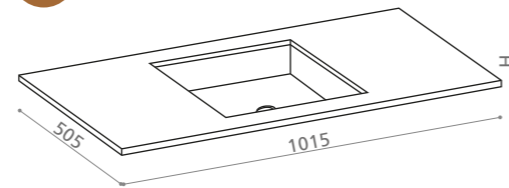

Four sotto 1015
TOPG101

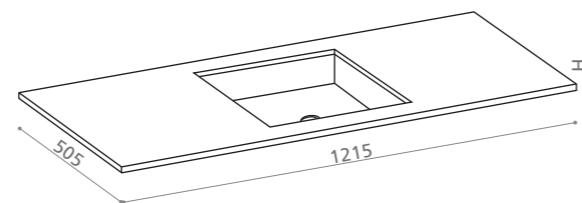

Four sotto 1215
TOPG121

1

Scegli il colore del TOP in vetro
Choose the colour
Full Colour Glass Top

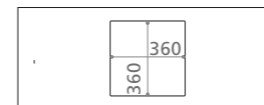

- bianco opaco/white mat
H 12mm code: BO
- bianco lucido/white gloss
H 12mm code: BL
- nero opaco/black mat
H 15mm code: NO
- nero lucido/black gloss
H 15mm code: NL

2

Scegli il colore del lavabo
Choose the washbasin colour
FOUR

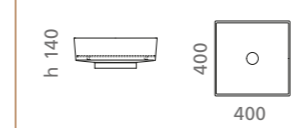

- foglia oro/gold leaf
code: FOUSFO
- foglia argento/silver leaf
code: FOUSFA
- bianco opaco/white mat
code: FOUSBO
- nero opaco/black mat
code: FOUSNO

3

Troppo pieno
Joint for overflow

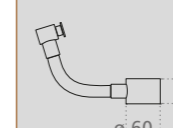

- oro/gold
code: TPG
- cromo/chrome
code: TP

4

Scegli il colore del carabotto
Choose the cover colour

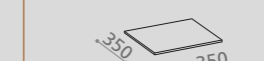

- foglia oro/gold leaf
code: CQFO
- foglia argento/silver leaf
code: CQFA
- bianco opaco/white mat
code: CQBO
- bianco lucido/white gloss
code: CQBL
- nero opaco/black mat
code: CQNO
- nero lucido/black gloss
code: CQNL

5

Scegli il colore e la misura del mobile.
(Comprensivo di attacchi a muro)
Choose colour and size for the
furniture.
(Wall fixing accessories included)

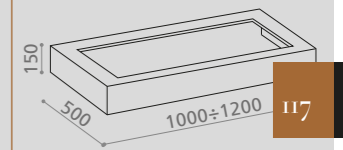

- bianco lucido 100/white gloss
code: SINB100
- bianco lucido 120/white gloss
code: SINB120
- nero lucido 100/black gloss
code: SINN100
- nero lucido 120/black gloss
code: SINN120

Rho SOTTO



A Scegli la dimensione
Choose the size

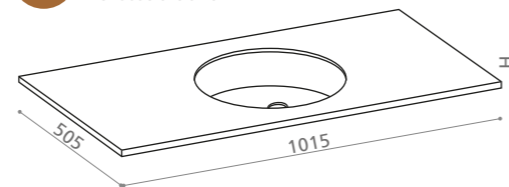

Rho sotto 1015
TOPG101

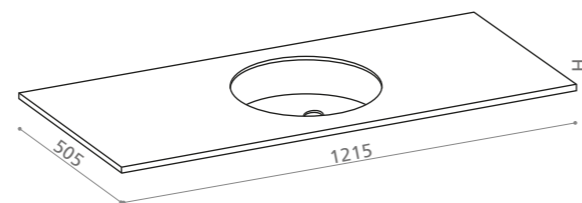

Rho sotto 1215
TOPG121

1

Scegli il colore del TOP in vetro
Choose the colour
Full Colour Glass Top



- bianco opaco/white mat
H 12mm code: BO
- bianco lucido/white gloss
H 12mm code: BL
- nero opaco/black mat
H 15mm code: NO
- nero lucido/black gloss
H 15mm code: NL

2

Scegli il colore del lavabo
Choose the washbasin colour
RHO

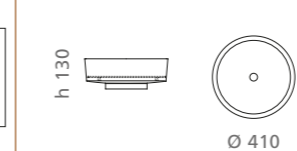

- foglia oro/gold leaf
code: RHOSFO
- foglia argento/silver leaf
code: RHOSFA
- bianco opaco/white mat
code: RHOSBO
- nero opaco/black mat
code: RHOSNO

3

Troppo pieno
Joint for overflow

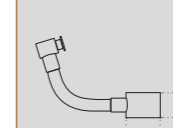

- oro/gold
code: TPG
- cromo/chrome
code: TP

4

Scegli il colore del carabotto
Choose the cover colour



- foglia oro/gold leaf
code: CTFO
- foglia argento/silver leaf
code: CTFA
- bianco opaco/white mat
code: CTBO
- bianco lucido/white gloss
code: CTBL
- nero opaco/black mat
code: CTNO
- nero lucido/black gloss
code: CTNL

5

Scegli il colore e la misura del mobile.
(Comprensivo di attacchi a muro)
Choose colour and size for the
furniture.
(Wall fixing accessories included)

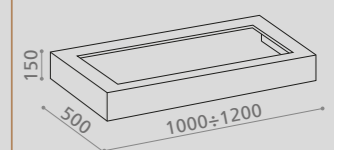

- bianco lucido 100/white gloss
code: SINB100
- bianco lucido 120/white gloss
code: SINB120
- nero lucido 100/black gloss
code: SINN100
- nero lucido 120/black gloss
code: SINN120

Flou SOTTO



A Scegli la dimensione
Choose the size

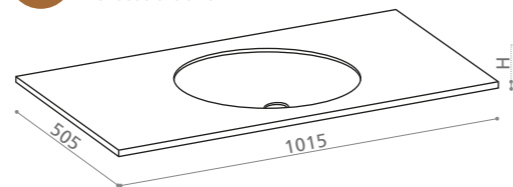

Flou sotto 1015
TOPG101

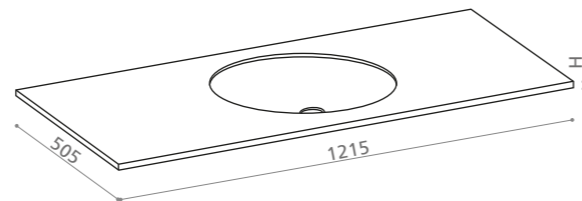

Flou sotto 1215
TOPG121

1

Scegli il colore del TOP in vetro
Choose the colour
Full Colour Glass Top

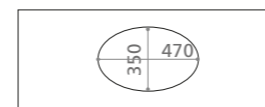

- bianco opaco/white mat
H 12mm code: BO
- bianco lucido/white gloss
H 12mm code: BL
- nero opaco/black mat
H 15mm code: NO
- nero lucido/black gloss
H 15mm code: NL

2

Scegli il colore del lavabo
Choose the washbasin colour
FLOU

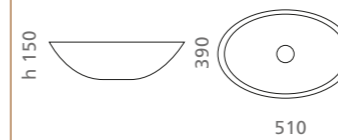

- foglia oro/gold leaf
code: FLOUSFO
- foglia argento/silver leaf
code: FLOUSFA
- nero lucido/black gloss
code: FLOUSNL

3

Troppo pieno
Joint for overflow

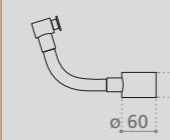

- oro/gold
code: TPG
- cromo/chrome
code: TP

4

Scegli il colore e la misura del mobile.
(Comprensivo di attacchi a muro)
Choose colour and size for the furniture.
(Wall fixing accessories included)

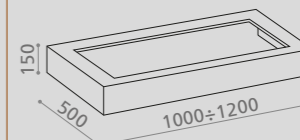

- bianco lucido 100/white gloss
code: SINB100
- bianco lucido 120/white gloss
code: SINB120
- nero lucido 100/black gloss
code: SINN100
- nero lucido 120/black gloss
code: SINN120

Bolla SOTTO



A Scegli la dimensione
Choose the size

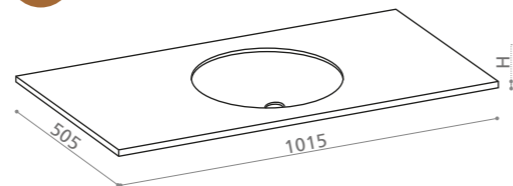

Bolla sotto 1015
TOPG101

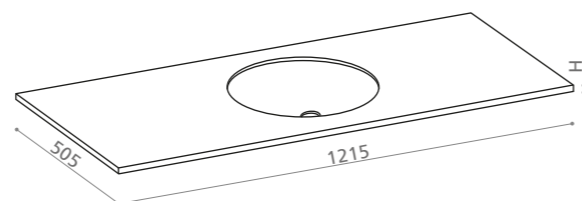

Bolla sotto 1215
TOPG121

1

Scegli il colore del TOP in vetro
Choose the colour
Full Colour Glass Top



- bianco opaco/white mat
H 12mm code: BO
- bianco lucido/white gloss
H 12mm code: BL
- nero opaco/black mat
H 15mm code: NO
- nero lucido/black gloss
H 15mm code: NL

2

Scegli il colore del lavabo
Choose the washbasin colour
BOLLA

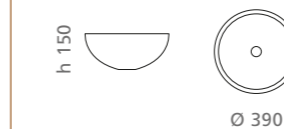

- foglia oro/gold leaf
code: BOLSF0
- foglia argento/silver leaf
code: BOLSF A
- nero lucido/black gloss
code: BOLSNL

3

Troppo pieno
Joint for overflow

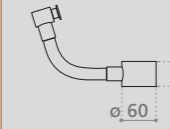

- oro/gold
code: TPG
- cromo/chrome
code: TP

4

Scegli il colore e la misura del mobile.
(Comprensivo di attacchi a muro)
Choose colour and size for the furniture.
(Wall fixing accessories included)

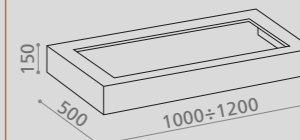

- bianco lucido 100/white gloss
code: SINB100
- bianco lucido 120/white gloss
code: SINB120
- nero lucido 100/black gloss
code: SINN100
- nero lucido 120/black gloss
code: SINN120

Yacht SOTTO



A Scegli la dimensione
Choose the size

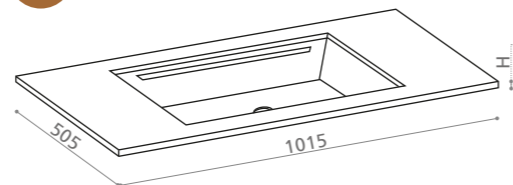

Yacht sotto 1015
TOPG101

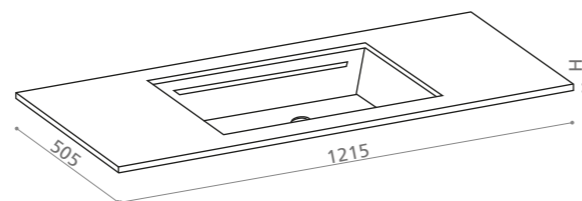

Yacht sotto 1215
TOPG121

1

Scegli il colore del TOP in vetro
Choose the colour
Full Colour Glass Top

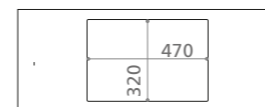

- bianco opaco/white mat
H 12mm code: BO
- bianco lucido/white gloss
H 12mm code: BL
- nero opaco/black mat
H 15mm code: NO
- nero lucido/black gloss
H 15mm code: NL

2

Scegli il colore del lavabo
Choose the washbasin colour
YACHT

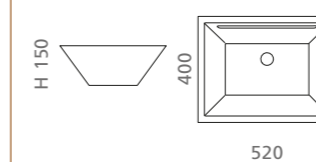

Troppo pieno integrato
Washbasin with integrated overflow

- bianco opaco/white mat
code: YACHTSBO

3

Scegli il colore e la misura del mobile. (Comprensivo di attacchi a muro)
Choose colour and size for the furniture. (Wall fixing accessories included)

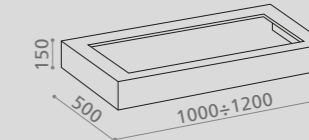

- bianco lucido 100/white gloss
code: SINB100
- bianco lucido 120/white gloss
code: SINB120
- nero lucido 100/black gloss
code: SINN100
- nero lucido 120/black gloss
code: SINN120





MOBILI FURNITURE SOLUTIONS



Il lusso nel piccolo *A luxury space saving solution*

La nostra filosofia è creare oggetti che al di là della loro dimensione possono suscitare emozioni e al tempo stesso siano pratici e tecnicamente funzionali. *Our philosophy is to create objects that stir up emotions larger than their size while at the same time exhibiting technical functionality and practicality. We have created*
Abbiamo pensato ad un prodotto adatto anche agli spazi più contenuti, riuscendo a realizzare mobili in stile moderno, classico e contemporaneo che potessero impreziosire anche il bagno più piccolo. *a product suitable for even the smallest of spaces, managing to create furniture in classic, contemporary and modern styles that will enrich even the smallest bathroom.*

“Monnalisa”

Affascinante come il concetto che lo ha ispirato.

As fascinating as the concept that inspires it.

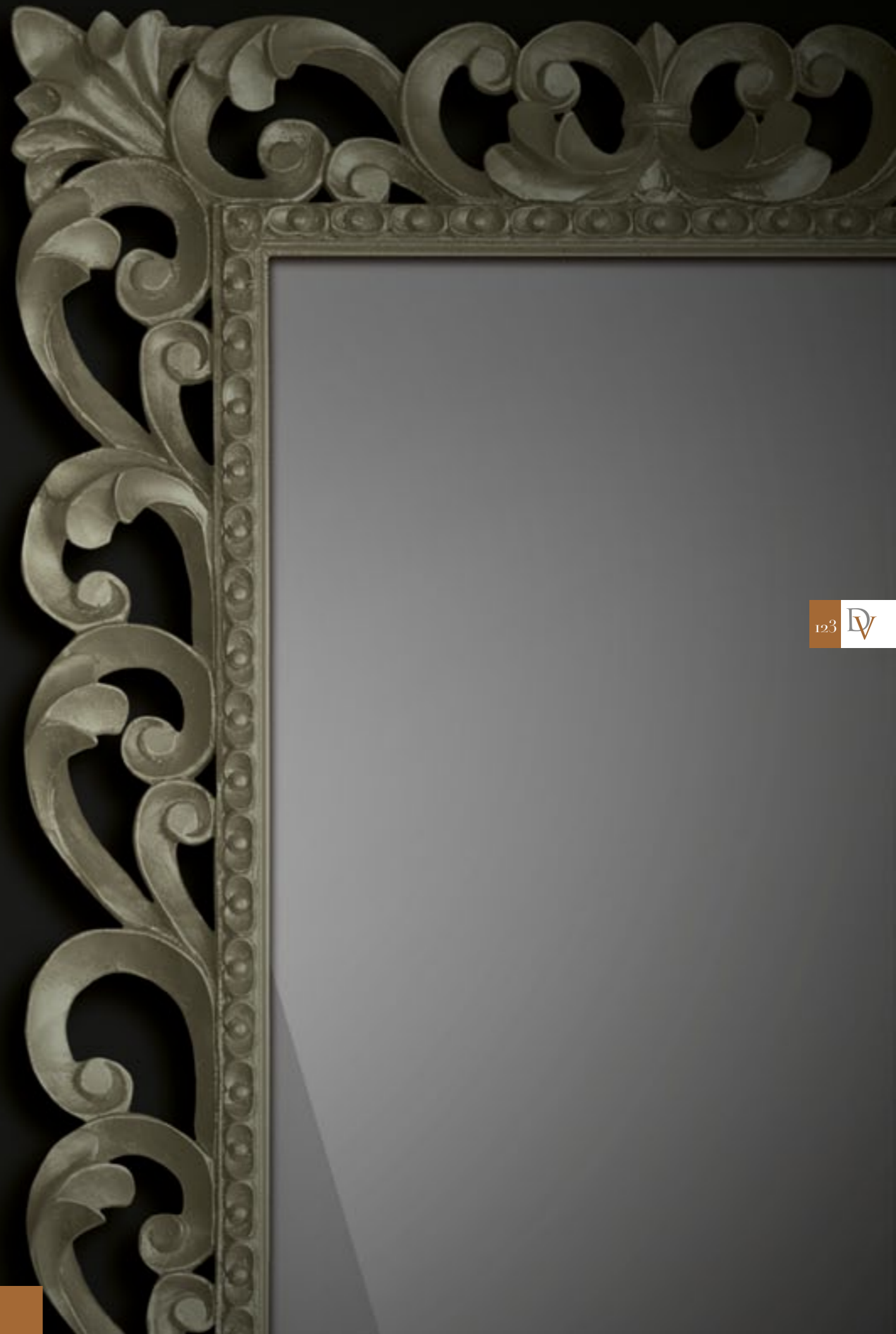

Monnalisa Prestige

design by: Giacomo Masoni





Monnalisa
PRESTIGE
 FLOWer red Ferrari

- **MOBILE:**
 legno laccato nero lucido, gambe e cornice finitura platino, pomolo cristallo Fiore trasparente/cromo
- **LAVABO:**
 FLOWer in Pert® rosso Ferrari con piletta cromo.
 Misure: Ø46 - H 30
- **FURNITURE:**
 Black gloss lacquered wood, legs and mirror frame platinum finish, crystal knob Fiore clear/chrome
- **WASHBASIN:**
 FLOWer Pert® Ferrari red with chrome waste.
 Sizes: Ø46 - H 30

code PRNPLPLFLRFITF4

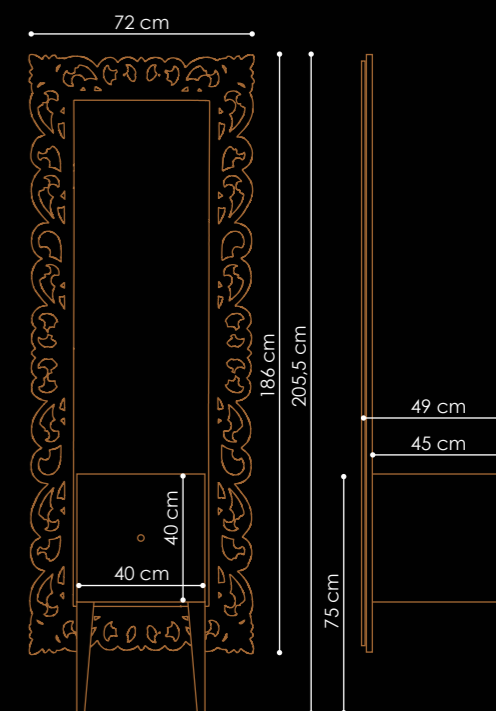



Monnalisa

PRESTIGE FLOWer red Ferrari

- **MOBILE:**
Legno laccato nero lucido, gambe e cornice finitura platino, pomolo cristallo Fiore trasparente/cromo
- **LAVABO:**
FLOWer in Pert® rosso Ferrari con piletta cromo.
Misure: Ø46 - H 30

- **FURNITURE:**
Black gloss lacquered wood, legs and mirror frame platinum finish, crystal knob Fiore clear/chrome
- **WASHBASIN:**
FLOWer Pert® Ferrari red with chrome waste.
Sizes: Ø46 - H 30

code PRNPLPLFLRFITF4



Monnalisa

PRESTIGE FLOWer platinum

- **MOBILE:**
Legno laccato bianco lucido, gambe e cornice finitura platino, pomolo cristallo Fiore trasparente/cromo.
- **LAVABO:**
FLOWer in Pert® platino con piletta cromo.
Misure: Ø46 - H 30

- **FURNITURE:**
white gloss lacquered wood, legs and mirror frame platinum finish, crystal knob Fiore clear/chrome.
- **WASHBASIN:**
FLOWer Pert® platinum with chrome waste.
Sizes: Ø46 - H 30

code PRBPLPLFLPLFITF4



Monnalisa

PRESTIGE FLOWer black

- **MOBILE:**
legno laccato nero lucido, gambe e cornice finitura argento, pomolo cristallo Fiore trasparente/cromo.
- **LAVABO:**
FLOWer in Pert® nero lucido con piletta cromo.
Misure: Ø46 - H 30

- **FURNITURE:**
black gloss lacquered wood, legs and mirror frame silver finish, crystal knob Fiore clear/chrome.
- **WASHBASIN:**
FLOWer Pert® black gloss with chrome waste.
Sizes: Ø46 - H 30

code PRNARARFLNFITF4



Monnalisa

PRESTIGE FLOWer white

- **MOBILE:**
legno laccato bianco lucido, gambe e cornice finitura argento, pomolo cristallo Fiore trasparente/cromo.
- **LAVABO:**
FLOWer in Pert® bianco lucido con piletta cromo.
Misure: Ø46 - H 30

- **FURNITURE:**
white gloss lacquered wood, legs and mirror frame silver finish, crystal knob Fiore clear/chrome.
- **WASHBASIN:**
FLOWer Pert® white gloss with chrome waste.
Sizes: Ø46 - H 30

code PRBARARFLBFITF4

Monnalisa Florence

design by: Giacomo Masoni





Monnalisa

FLORENCE MOSAIC gold

- MOBILE: legno laccato bianco lucido, gambe e cornice finitura foglia oro, pomolo cristallo Sfera trasparente/oro.
 - LAVABO: MOSAIC in TeknoForm® foglia oro con piletta e anello cromo.
- Misure: Ø42 - H 15,8

- FURNITURE: white gloss lacquered wood, legs and mirror frame gold leaf finish, crystal knob Sfera clear/gold.
 - WASHBASIN: MOSAIC TeknoForm® gold leaf with chrome waste and base ring.
- Sizes: Ø42 - H 15,8
code FLBFOFOMSFSOFTF3

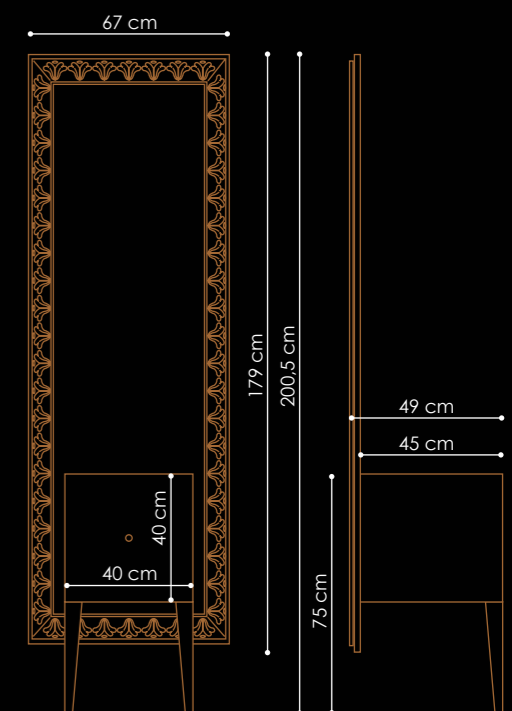

Monnalisa Class



design by: Giacomo Masoni





Monnalisa

CLASS FILIGRANA black/silver

- MOBILE: legno laccato nero lucido, gambe e cornice finitura foglia argento, pomolo cristallo Sfera trasparente/cromo.
 - LAVABO: FILIGRANA in cristallo (Florence Glass Atelier®) nero/foglia argento con piletta cromo (oro su richiesta).
- Misure: Ø40 - H 15
- FURNITURE: black gloss lacquered wood, legs and mirror frame silver leaf finish, crystal knob Sfera clear/chrome.
 - WASHBASIN: FILIGRANA crystal (Florence Glass Atelier®) black/silver leaf with chrome waste (gold waste upon demand). Sizes: Ø40 - H 15

code CLNFAFAFILBSSFTF4



Monnalisa

CLASS FILIGRANA white/gold

- MOBILE: legno laccato bianco lucido, gambe e cornice finitura foglia oro, pomolo cristallo Sfera trasparente/oro.
 - LAVABO: FILIGRANA in cristallo (Florence Glass Atelier®) bianco/foglia oro con piletta e anello cromo. Piletta e anello oro su richiesta.
- Misure: Ø40 - H 16,3

- FURNITURE: white gloss lacquered wood, legs and mirror frame gold leaf finish, crystal knob Sfera clear/gold.
 - WASHBASIN: FILIGRANA crystal (Florence Glass Atelier®) white/gold leaf with chrome waste and base ring. Gold waste and gold ring upon demand.
- Sizes: Ø40 - H 16,3

code CLBFOFOFILWGSFTF3

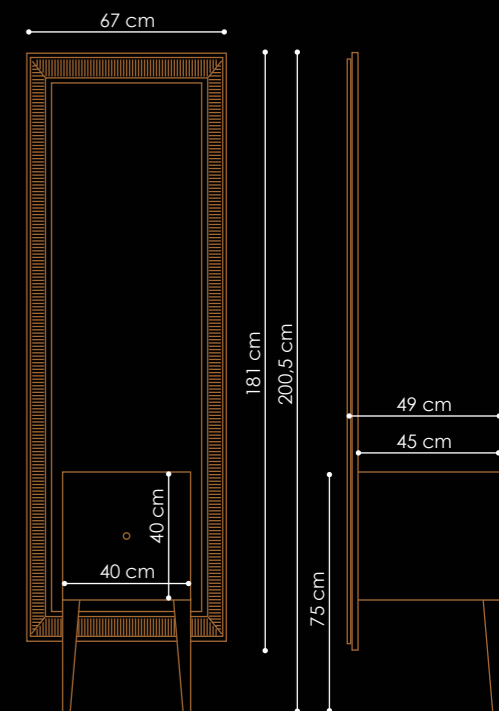

“Misura”

Raccordi essenziali.

The essential joint.

MISURA UNO



MISURA UNO Soffio

- MOBILE: legno laccato platino, chiusura slow motion, pomolo Madreperla Perla Quadro smoke
- SPECCHIO: legno laccato platino. Misure 120x60cm
- LAVABO: Soffio cristallo trasparente (Florence Glass Atelier ®) con piletta e anello cromo. Misura: Ø40 - H 15cm
- FURNITURE: platinum lacquered wood with slow motion hinges, Mother of Pearl knob Perla Quadro smoke.
- MIRROR FRAME: platinum lacquered wood. Size 120x60cm
- WASHBASIN: SOFFIO clear crystal (Florence Glass Atelier ®) with chrome waste and base ring. Size: Ø40 - H 15cm

code MS1PLPLSFT01PQS



MISURA UNO Soffio

- **MOBILE:**
legno laccato bianco opaco, chiusura Slow Motion.
Pomolo Madreperla Quadro bianco
- **SPECCHIO:**
legno laccato bianco opaco. Misure 120x60cm
- **LAVABO:**
Soffio cristallo trasparente (Florence Glass Atelier®) con piletta e anello cromo. Misura: Ø40 - H 15cm
- **FURNITURE:**
white mat lacquered wood with slow motion hinges.
Mother of Pearl knob Quadro white.
- **MIRROR FRAME:**
white mat lacquered wood. Size 120x60cm
- **WASHBASIN:**
Soffio clear crystal (Florence Glass Atelier®) with chrome waste and base ring. Size: Ø40 - H 15cm

code MS1BOBOBOSFT01PQP

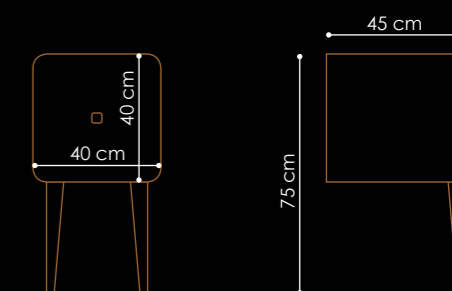

MISURA DUE



MISURA DUE Exté

- MOBILE: legno laccato nero opaco, chiusura Slow Motion. Pomolo Madreperla Quadro smoke.
- SPECCHIO: legno laccato nero opaco.
- LAVABO: Exté in Alumix® finitura nero/argento con piletta cromo. Misura: Ø42 - H 14,5cm

- FURNITURE: black mat lacquered wood with slow motion hinges. Mother of Pearl knob Quadro smoke.
- MIRROR FRAME: black mat lacquered wood.
- WASHBASIN: Exté Alumix® black/silver finish with chrome waste. Size: Ø42 - H 14,5cm

code MS2NONONOEX02PQS

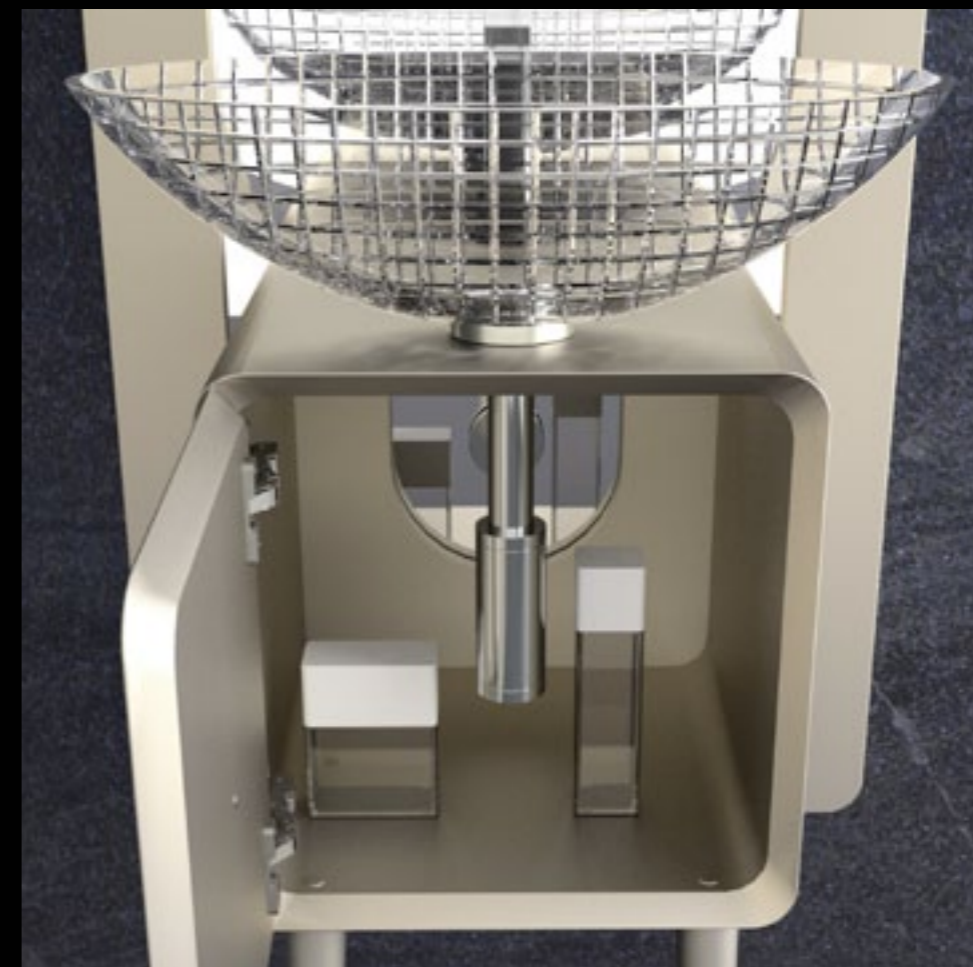

MISURA DUE Luxor Oval

- **MOBILE:**
legno laccato platino, chiusura Slow Motion.
Pomolo Madreperla Quadro smoke.
- **SPECCHIO:**
legno laccato platino.
- **LAVABO:**
Luxor Oval cristallo 24%pb trasparente (Cristallo de' Medici ®)
con piletta e anello cromo. Misura: L51 - P 34,5 - H16,8cm
- **FURNITURE:**
platinum lacquered wood with slow motion hinges.
Mother of Pearl knob Quadro smoke.
- **MIRROR FRAME:**
platinum lacquered wood.
- **WASHBASIN:**
Luxor Oval clear crystal 24% pb (Cristallo de' Medici ®)
with chrome waste and base ring. Size: W51 - D 34,5 - H16,8cm

code MS2PLPLLOVT01PQ

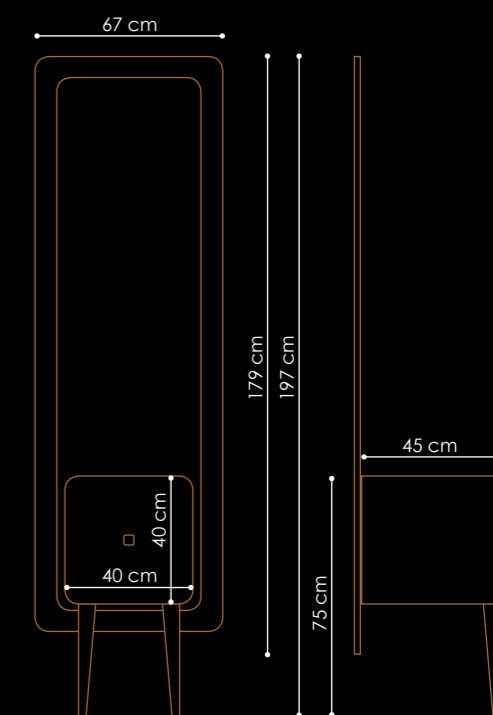

MISURA TRE



MISURA TRE Canale

- **MOBILE:** legno laccato bianco opaco, chiusura Slow Motion. Pomoli Madreperla Quadro bianco.
- **SPECCHIO:** legno laccato bianco opaco.
Misure 120x60cm
- **LAVABO:** Canale in Vetro di Murano con piletta e anello cromo.
Misura: Ø37 - H 21cm

- **FURNITURE:** white mat lacquered wood with slow motion hinges. Mother of Pearl knobs Quadro white.
- **MIRROR FRAME:** white mat lacquered wood.
Size 120x60cm
- **WASHBASIN:** Canale Murano Glass with chrome waste and base ring.
Size: Ø37 - H 21cm

code MS3BOBOBOCNPQP





MISURA TRE Flou

- **MOBILE:**
legno laccato nero opaco, chiusura Slow Motion.
Pomoli Madreperla Quadro smoke.
- **SPECCHIO:** legno laccato nero opaco.
Misure 120x60cm
- **LAVABO:** Flou in cristallo (Florence Glass Atelier ®)
finitura nero/argento con piletta e anello cromo.
Misura: L51 – P39 – H15cm

- **FURNITURE:**
black mat lacquered wood with slow motion hinges.
Mother of Pearl knobs Quadro smoke.
- **MIRROR FRAME:** black mat lacquered wood.
Size 120x60cm
- **WASHBASIN:** Flou crystal (Florence Glass Atelier ®)
black/silver finish with chrome waste and base ring.
Size: W51 – D39 – H15cm

code MS3NONONOFBSPQS

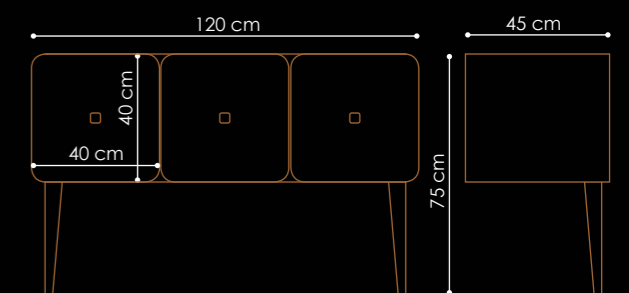

“Leonardo”

Insospettabile fascino della semplicità.

Unexpected charm of simplicity.

CUBUS





Leonardo
CUBUS
 KOOL MAX black

- MOBILE: legno laccato nero lucido.
 - LAVABO: Kool Max in VetroFreddo® nero opaco con piletta cromo.
- Misure lavabo: L 54 - P 40 - H 15
 Ingombro totale: L 54 - P 45 - H 55
- FURNITURE: black gloss lacquered wood.
 - WASHBASIN Kool Max VetroFreddo® black mat with chrome waste.
- Washbasin sizes: W 54 - D 40 - H 15
 Overall sizes: W 54 - D 45 - H 55

code CUBUSNLKMP030

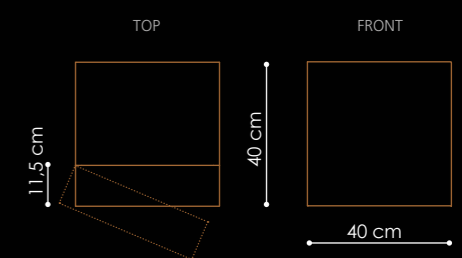



Leonardo

CUBUS KOOL MAX white

- MOBILE: legno laccato bianco lucido.
 - LAVABO: Kool Max in VetroFreddo® bianco opaco con piletta cromo.
- Misure lavabo: L 54 - P 40 - H 15
Ingombro totale: L 54 - P 45 - H 55

- FURNITURE: white gloss lacquered wood.
 - WASHBASIN: Kool Max VetroFreddo® white mat with chrome waste.
- Washbasin sizes: W 54 - D 40 - H 15
Overall sizes: W 54 - D 45 - H 55

code CUBUSBLKMP001



Leonardo

CUBUS KOOL MAX white

- MOBILE: legno laccato nero lucido.
 - LAVABO: Kool Max VetroFreddo® bianco opaco con piletta cromo.
- Misure lavabo: L 54 - P 40 - H 15
Ingombro totale: L 54 - P 45 - H 55

- FURNITURE: black gloss lacquered wood.
 - WASHBASIN: Kool Max VetroFreddo® white mat with chrome waste.
- Washbasin sizes: W 54 - D 40 - H 15
Overall sizes: W 54 - D 45 - H 55

code CUBUSNLKMP001



Leonardo

CUBUS KOOL MAX white

- MOBILE: legno finitura foglia oro.
 - LAVABO: Kool Max in VetroFreddo® bianco opaco con piletta cromo.
- Misure lavabo: L 54 - P 40 - H 15
Ingombro totale: L 54 - P 45 - H 55

- FURNITURE: gold leaf finish wood.
 - WASHBASIN: Kool Max VetroFreddo® white mat with chrome waste.
- Washbasin sizes: W 54 - D 40 - H 15
Overall sizes: W 54 - D 45 - H 55

code CUBUSFOKMP001



Leonardo

CUBUS KOOL MAX black

- MOBILE: legno finitura foglia argento.
 - LAVABO: Kool Max VetroFreddo® nero opaco con piletta cromo.
- Misure lavabo: L 54 - P 40 - H 15
Ingombro totale: L 54 - P 45 - H 55

- FURNITURE: silver leaf finish wood.
 - WASHBASIN: Kool Max VetroFreddo® black mat with chrome waste.
- Washbasin sizes: W 54 - D 40 - H 15
Overall sizes: W 54 - D 45 - H 55

code CUBUSFAKMP030

CANTO SMALL





Leonardo

CANTO ICE OVAL Small

- MOBILE: legno laccato nero lucido con cassetto, piano vetro nero, pomolo cristallo Deluxe trasparente/cromo.
- LAVABO: ICE OVAL Small cristallo 24% pb trasparente (Cristallo De' Medici®) con piletta e anello cromo. Misure lavabo: L 43 - P 28 - H 14,3
Ingombro totale: L 61,5 - P 36 - H 87

- FURNITURE: black gloss lacquered wood with drawer, black glass top, crystal knob Deluxe clear/chrome.
- WASHBASIN: ICE OVAL Small clear crystal 24% pb. (Cristallo De' Medici®) with chrome waste and base ring. Washbasin sizes: W 43 - D 28 - H 14,3
Overall sizes: W 61,5 - D 36 - H 87

code CANTONLNIOSD1T1

Specchio tondo laccato nero lucido Ø70
Round mirror black gloss Ø70
code FLOMIRRONL

DV 162

163 DV

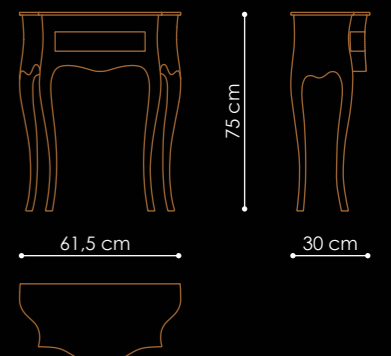



Leonardo

CANTO ICE OVAL Small

- MOBILE: legno laccato bianco lucido con cassetto, piano vetro nero, pomolo cristallo Deluxe nero/cromo.
 - LAVABO: ICE OVAL Small cristallo 24% pb nero (®Cristallo De' Medici) con piletta e anello cromo.
- Misure lavabo: L 43 - P 28 - H 14,3
Ingombro totale: L 61,5 - P 36 - H 87

- FURNITURE: white gloss lacquered wood with drawer, black glass top, crystal knob Deluxe black/chrome.
 - WASHBASIN: ICE OVAL Small black crystal 24% pb (®Cristallo De' Medici) with chrome waste and base ring.
- Washbasin sizes: W 43 - D 28 - H 14,3
Overall sizes: W 61,5 - D 36 - H 87

code CANTOBLNIOST3DLT3

- Specchio tondo laccato bianco lucido Ø70 cm. Round mirror white gloss Ø70: cod FLOMIRROBL

CANTO XL

DV 166

167 DV

Leonardo

CANTO XL FLARE Tech black/silver

- **MOBILE:** legno laccato bianco lucido con due cassetti, piano vetro nero, pomoli cristallo Deluxe trasparente/ cromo.
- **LAVABO:** FLARE Tech in cristallo (Florence Glass Atelier®) finitura nero/foglia argento con pileta e anello cromo. Misure lavabo: Ø40 - H 16,3
Ingombro totale: L 97 - P 51 - H 91

- **FURNITURE:** white gloss lacquered wood with two drawers, black glass top, crystal knobs Deluxe clear/ chrome.
- **WASHBASIN:** FLARE Tech crystal (Florence Glass Atelier®) black/silver leaf finish with chrome waste and base ring. Washbasin sizes: Ø40 - H 16,3
Overall sizes: W 97 - D 51 - H 91

Specchio tondo laccato bianco lucido Ø 70
Round mirror white gloss Ø 70

code CANTOXLBNFTBSDLT

code FLOMIRROBL

Furniture

Solutions



Leonardo
CANTO XL
 ICE OVAL

- MOBILE: legno laccato nero lucido con due cassetti, piano vetro nero, pomoli cristallo Deluxe trasparente/cromo.
 - LAVABO: ICE OVAL cristallo 24% pb trasparente (Cristallo De' Medici®) con pilettta e anello cromo.
- Misure lavabo: L 51 - P 34,5 - H 16,8
 Ingombro totale: L 97 - P 41 - H 92

- FURNITURE: black gloss lacquered wood with two drawers, black glass top, crystal knobs Deluxe clear/chrome.
 - WASHBASIN: ICE OVAL clear crystal 24%pb (Cristallo De' Medici®) with chrome waste and base ring.
- Washbasin sizes: W 51 - D 34,5 - H 16,8
 Overall sizes: W 97 - D 41 - H 92

code CANTOXLNLIOT1DLT

Specchio ovale laccato nero lucido 95 x 65cm
 Oval mirror black gloss 95 x 65cm

code FLOMIROVNL

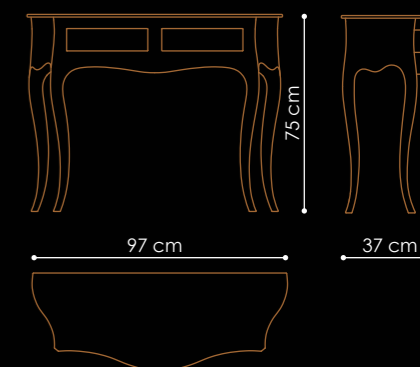

KOIN MEDIO



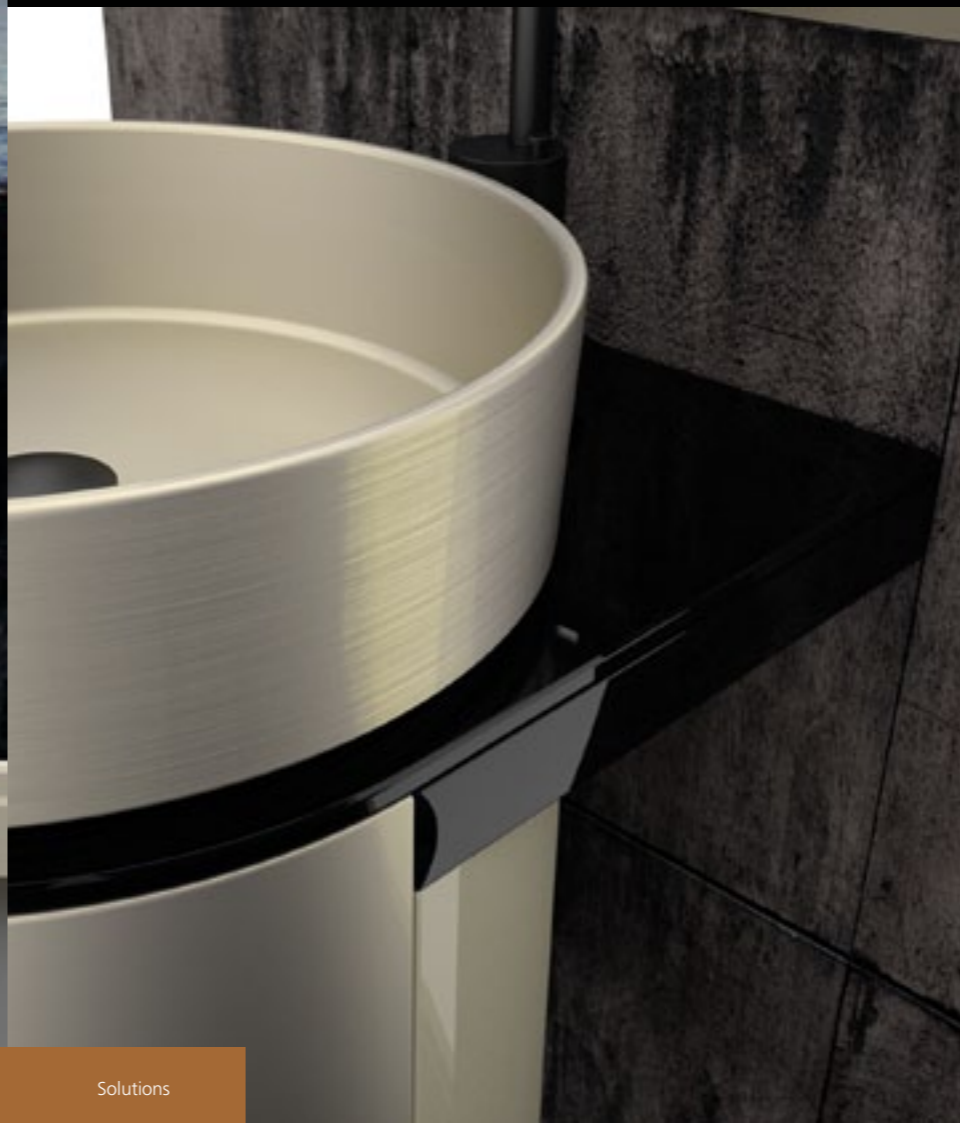

Leonardo

KOIN MEDIO RHO Platinum

- **MOBILE:** legno laccato platino, piano vetro nero.
 - **LAVABO:** RHO in Pert® finitura Metal Platino con piletta nera.
- Misure lavabo: Ø41 - H 13
Ingombro totale: L 41 - P 53,5 - H 56

- **FURNITURE:** platinum lacquered wood, black glass top.
 - **WASHBASIN:** RHO Pert® Metal Platinum finish with black waste.
- Washbasin sizes: Ø41 - H 13
Overall sizes: W 41 - D 53,5 - H 56

code KOINMPLNRHOPLN

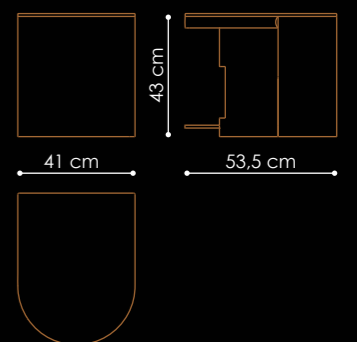



Leonardo

KOIN MEDIO RHO black

- MOBILE: legno laccato inox scuro, piano vetro nero.
 - LAVABO: RHO in Pert® nero lucido con piletta cromo.
- Misure lavabo: Ø41 - H 13
Ingombro totale: L 41 - P 53,5 - H 56

- FURNITURE: dark inox lacquered wood, black glass top.
 - WASHBASIN: RHO Pert® black gloss with chrome waste.
- Washbasin sizes: Ø41 - H 13
Overall sizes: W 41 - D 53,5 - H 56

code KOINMDINRHONL



Leonardo

KOIN MEDIO RHO dark inox

- MOBILE: legno laccato inox scuro, piano vetro nero.
 - LAVABO: RHO in Pert® finitura Metal inox scuro con piletta cromo.
- Misure lavabo: Ø41 - H 13
Ingombro totale: L 41 - P 53,5 - H 56

- FURNITURE: dark inox lacquered wood, black glass top.
 - WASHBASIN: RHO Pert® Metal dark inox finish with chrome waste.
- Washbasin sizes: Ø41 - H 13
Overall sizes: W 41 - D 53,5 - H 56

code KOINMDINRHODI



Leonardo

KOIN MEDIO RHO white

- MOBILE: legno laccato nero lucido, piano vetro nero.
 - LAVABO: RHO in Pert® bianco lucido con piletta cromo.
- Misure lavabo: Ø41 - H 13
Ingombro totale: L 41 - P 53,5 - H 56

- FURNITURE: black gloss lacquered wood, black glass top.
 - WASHBASIN: RHO Pert® white gloss with chrome waste.
- Washbasin sizes: Ø41 - H 13
Overall sizes: W 41 - D 53,5 - H 56

code KOINMNLNRHOBL



Leonardo

KOIN MEDIO RHO platinum

- MOBILE: legno laccato bianco lucido, piano vetro bianco.
 - LAVABO: RHO in Pert® finitura Metal platino con piletta cromo.
- Misure lavabo: Ø41 - H 13
Ingombro totale: L 41 - P 53,5 - H 56

- FURNITURE: white gloss lacquered wood, white glass top.
 - WASHBASIN: RHO Pert® Metal platinum finish with chrome waste.
- Washbasin sizes: Ø41 - H 13
Overall sizes: W 41 - D 53,5 - H 56

code KOINMBLBRHOPL

KOIN XL



Leonardo
KOIN XL
FLOWer red Ferrari

- MOBILE: legno laccato bianco lucido, piano vetro bianco.
 - LAVABO: FLOWER in Pert® rosso Ferrari con piletta cromo.
- Misure lavabo: Ø46 - H 30
Ingombro totale: Ø 46 - H 107

- FURNITURE: white gloss lacquered wood, white glass top.
 - WASHBASIN: FLOWER Pert® Ferrari red with chrome waste.
- Washbasin sizes: Ø46 - H 30
Overall sizes: Ø 46 - H 107

Vasca da bagno in "Bi-Mat" rosso Ferrari con interno bianco lucido
Bathtub Bi-Mat Ferrari red finish, white gloss inside

code KOINXLBLFLR

code FLOSTYRDW

Furniture

Solutions



Leonardo
KOIN XL
 FLOWer red Ferrari

- MOBILE: legno laccato bianco lucido, piano vetro bianco.
 - LAVABO: FLOWER Pert® rosso Ferrari con piletta cromo.
- Misure lavabo: Ø46 - H 30
 Ingombro totale: Ø 46 - H 107

- FURNITURE: white gloss lacquered wood, white glass top.
 - WASHBASIN: FLOWER Pert® Ferrari red with chrome waste.
- Washbasin sizes: Ø46 - H 30
 Overall sizes: Ø 46 - H 107

code KOINXLBLBFLR

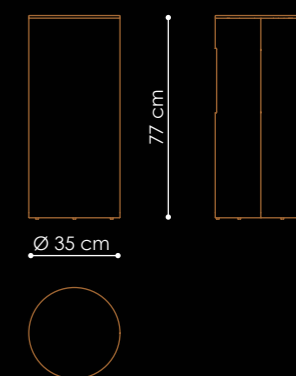



Leonardo

KOIN XL FLOWER silver

- MOBILE: legno laccato nero lucido, piano vetro nero.
 - LAVABO: FLOWER in Pert® finitura foglia argento con piletta cromo.
- Misure lavabo: Ø46 - H 30
Ingombro totale: Ø 46 - H 107

- FURNITURE: black gloss lacquered wood, black glass top.
 - WASHBASIN: FLOWER Pert® silver leaf finish with chrome waste.
- Washbasin sizes: Ø46 - H 30
Overall sizes: Ø 46 - H 107

code KOINXLNLFNFA



Leonardo

KOIN XL GLOBALL inox

- MOBILE: legno laccato inox scuro, piano vetro nero.
 - LAVABO: GLOBALL in acciaio inox lucido (InoxZero®) con piletta cromo.
- Misure lavabo: Ø40 - H 10,7
Ingombro totale: Ø 40 - H 88

- FURNITURE: dark inox lacquered wood, black glass top.
 - WASHBASIN: GLOBALL shiny stainless steel (InoxZero®) with chrome waste.
- Washbasin sizes: Ø40 - H 10,7
Overall sizes: Ø 40 - H 88

code KOINXLDINGLIL01



Leonardo

KOIN XL MOSAIC black

- MOBILE: legno laccato platino, piano vetro nero.
 - LAVABO: MOSAIC in TeknoForm® nero opaco con piletta cromo.
- Misure lavabo: Ø42 - H 15,8
Ingombro totale: Ø 42 - H 93

- FURNITURE: platinum lacquered wood, black glass top.
 - WASHBASIN: MOSAIC TeknoForm® black mat with chrome waste.
- Washbasin sizes: Ø42 - H 15,8
Overall sizes: Ø 42 - H 93

code KOINXLPLNMSPO30



Leonardo

KOIN XL VENICE gold/silver

- MOBILE: legno laccato bianco lucido, piano vetro bianco.
 - LAVABO: VENICE in cristallo (Florence Glass Atelier®) finitura oro/argento con piletta e anello cromo.
- Misure lavabo: Ø44 - H 16,3
Ingombro totale: Ø 44 - H 94

- FURNITURE: white gloss lacquered wood, white glass top.
 - WASHBASIN: VENICE crystal (Florence Glass Atelier®) gold/silver finish with chrome waste and base ring.
- Washbasin sizes: Ø44 - H 16,3
Overall sizes: Ø 44 - H 94

code KOINXLBLBVNOA

MUSA



Leonardo
MUSA
RHO gold leaf

- CONSOLLE: legno laccato nero lucido con gambe finitura foglia oro. Misure L 105 - P 55 - H 75
- LAVABO: RHO in Pert® finitura foglia oro con piletta cromo. Misure D 41 - H 13

- *CONSOLE: black gloss lacquered wood with gold leaf legs. Sizes W 105 - D 55 - H 75*
- *WASHBASIN: RHO Pert® @ gold leaf finish with chrome waste. Size D 41 - H 13*

code MUSANLFORHOFO

Leonardo
MUSA
FOUR silver leaf

- CONSOLLE: legno laccato nero lucido con gambe finitura foglia argento. Misure L 105 - P 55 - H 75
- LAVABO: FOUR in Pert® finitura foglia argento con piletta cromo. Misure L 40 - P 40 - H 14

- *CONSOLE: black gloss lacquered wood with silver leaf legs. Sizes W 105 - D 55 - H 75*
- *WASHBASIN: FOUR Pert® @ silver leaf finish with chrome waste. Size W 40 - D 40 - H 14*

code MUSANLFAFOUFA







DOCCIA

SHOWER TRAYS SOLUTIONS





L'essenza della
NATURA
del legno impreziosito

The natural essence of enriched wood

La serie Natura Lux comprende piatti doccia, top per lavabi e lastre di rivestimento per garantire la massima coordinabilità.

Realizzati in Teknoform®, il materiale delle texture a rilievo, vi doneranno la vera essenza del legno.

Il composto di resine termoindurenti, cariche di minerali naturali, è impreziosito con smalti in oro o argento e trasformano il prodotto in un vero e proprio oggetto d'arredo.

The NATURA LUX collection includes shower trays, tops and wall-covering tiles, all designed to match the full product range.

NATURA LUX is finished in our Teknoform® texture relief material, lending the collection the true essence of wood. The special composition of resins mixed with mineral fillers is enriched with precious gold and silver enamels, creating a true furnishing object.

NATURA LUX



In foto/on photo
 Piatto doccia Natura Lux oro/avorio. Dim. 180x90x3 cm
 Shower tray Natura lux gold/ivory. Size 180x90x3 cm
 code SHW90X180GD

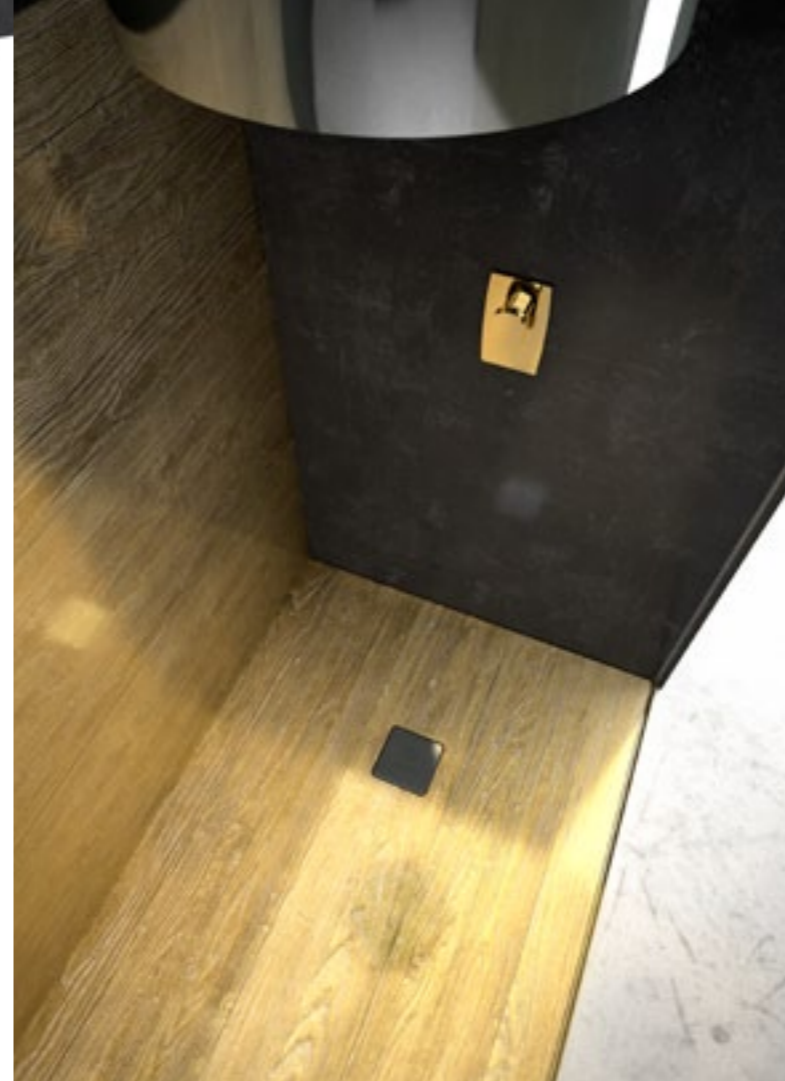

NATURA LUX GOLD

Texture legno a rilievo con smalto oro su avorio.

• **PIATTI DOCCIA**
 Oltre alla loro eleganza ed originalità stilistica, i piatti doccia si distinguono per la loro flessibilità di posa e l'ampio assortimento dimensionale che va da 80 cm fino ai 200 cm. Grazie allo spessore ridotto di soli 3 cm, il piatto doccia può essere installato filo pavimento o in appoggio. Ogni piatto doccia è provvisto di griglia in acciaio inox.

• **LASTRE DI RIVESTIMENTO**
 Le lastre di rivestimento sono il complemento ideale per il piatto doccia. La loro lunghezza segue quella dei piatti doccia che va da 80 cm fino a 200 cm con un'altezza di 55cm

Wood relief texture with gold enamel on ivory colour base.

• **SHOWER TRAYS**
 In addition to their elegance and originality of style, the shower trays are distinguished by their flexibility of installation and dimensions ranging from 80cm to 200cm. Thanks to the reduced thickness of only 3cm, the shower tray can be installed either on top or flush with the flooring. Each shower tray is supplied with a stainless steel drain.

• **WALL COVERING TILES**
 Wall covering tiles are the perfect complement to the shower tray. Their sizes follow those of the shower trays with a length ranging from 80 cm to 200 cm and a height of 55 cm.

FLESSIBILITÀ DI POSA - GREATEST FLEXIBILITY ON INSTALLATION

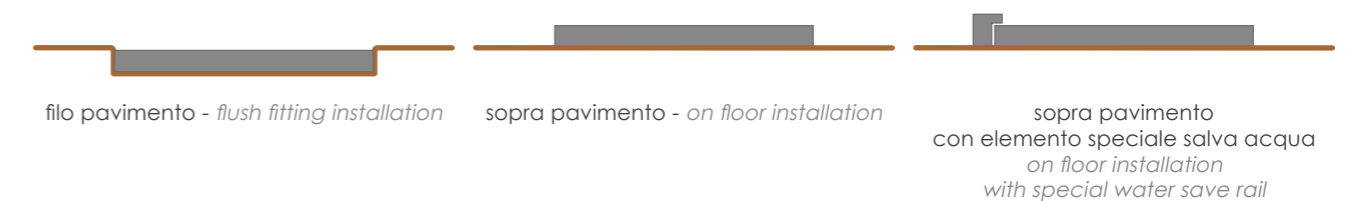



In foto/on photo
 Top Natura lux oro/avorio. Dim. 100x50x10 cm
 Top Natura lux gold/ivory. Size 100x50x10 cm
 code: TOPW100X50GD

Lavabo Laguna Night in Vetro di Murano. Dim. Ø41cm h 17,5 cm
 Washbasin Laguna Night in Murano Glass. Size. Ø41cm h 17,5 cm
 code: LAGUNAT33



NATURA LUX GOLD

Texture legno a rilievo con smalto oro su avorio.

- TOP
 Il piano lavabo è realizzato in Teknoform®, con texture legno a rilievo. Disponibile in 2 misure: L 100/120 x 50 x H 10 cm.

- LAVABO LAGUNA
 Lavabo da appoggio in vetro di Murano fornito con piletta e anello cromati.

Wood relief texture with gold enamel on ivory colour base.

- TOP
 The Top is produced in Teknoform® with wood relief texture. Available in 2 sizes: W 100/120 x 50 x H 10 cm.

- LAGUNA WASHBASIN
 Counter top washbasin in Murano glass supplied with chrome waste and base ring.

FLESSIBILITÀ DI INSTALLAZIONE - GREATEST FLEXIBILITY ON INSTALLATION



NATURA LUX SILVER

Texture legno a rilievo con smalto argento su avorio.

- PIATTI DOCCIA

Oltre alla loro eleganza ed originalità stilistica, i piatti doccia si distinguono per la loro flessibilità di posa e l'ampio assortimento dimensionale che va da 80 cm fino ai 200 cm. Grazie allo spessore ridotto di soli 3 cm, il piatto doccia può essere installato filo pavimento o in appoggio. Ogni piatto doccia è provvisto di griglia in acciaio inox.

- LASTRE DI RIVESTIMENTO

Le lastre di rivestimento sono il complemento ideale per il piatto doccia. La loro lunghezza segue quella dei piatti doccia che va da 80 cm fino a 200 cm con un'altezza di 55cm.

- TOP

Il piano lavabo è realizzato in Teknoform®, con texture legno a rilievo. Disponibile in 2 misure: L 100/120 x 50 x H 10 cm.

- LAVABO LAGUNA

lavabo da appoggio in vetro di Murano fornito con piletta e anello cromati.

Wood relief texture with silver enamel on ivory colour base.

- SHOWER TRAYS

In addition to their elegance and originality of style, the shower trays are distinguished by their flexibility of installation and dimensions ranging from 80cm to 200cm. Thanks to the reduced thickness of only 3cm, the shower tray can be installed either on top or flush with the flooring. Each shower tray is supplied with a stainless steel drain.

- WALL COVERING TILES

Wall covering tiles are the perfect complement to the shower tray. Their sizes follow those of the shower trays with a length ranging from 80 cm to 200 cm and a height of 55 cm.

- TOP

The Top is produced in Teknoform®, available in two sizes: W 100/120 x 50 x H 10 cm.

- LAGUNA WASHBASIN

Counter top washbasin in Murano glass supplied with chrome waste and base ring.



FLESSIBILITÀ DI POSA - GREATEST FLEXIBILITY ON INSTALLATION

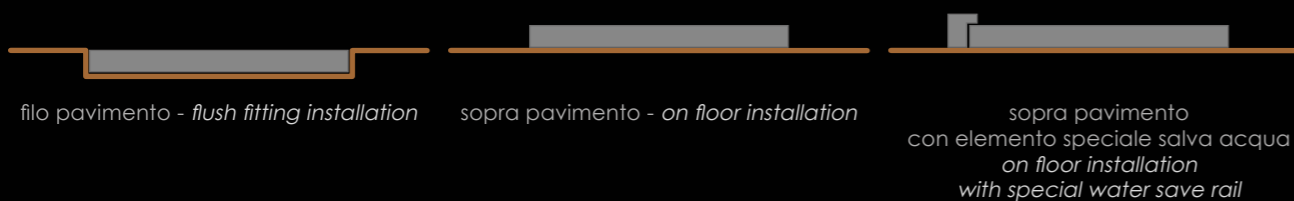

FLESSIBILITÀ DI INSTALLAZIONE - GREATEST FLEXIBILITY ON INSTALLATION



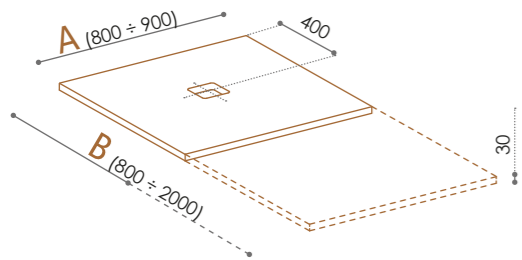

Piatti doccia Shower trays

B	A	A
	800 mm	900 mm
cm	cod.	cod.
80	SHW80X80GD	
90	SHW80X90GD	SHW90X90GD
100	SHW80X100GD	SHW90X100GD
110	SHW80X110GD	SHW90X110GD
120	SHW80X120GD	SHW90X120GD
130	SHW80X130GD	SHW90X130GD
140	SHW80X140GD	SHW90X140GD
150	SHW80X150GD	SHW90X150GD
160	SHW80X160GD	SHW90X160GD
170	SHW80X170GD	SHW90X170GD
180	SHW80X180GD	SHW90X180GD
190	SHW80X190GD	SHW90X190GD
200	SHW80X200GD	SHW90X200GD

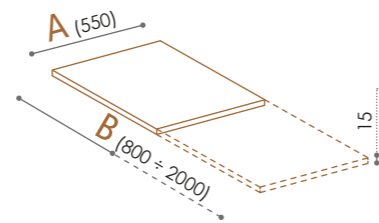

Rivestimenti Wall covering

B	A
	550 mm
cm	cod.
80	TLW55X80GD
90	TLW55X90GD
100	TLW55X100GD
110	TLW55X110GD
120	TLW55X120GD
130	TLW55X130GD
140	TLW55X140GD
150	TLW55X150GD
160	TLW55X160GD
170	TLW55X170GD
180	TLW55X180GD
190	TLW55X190GD
200	TLW55X200GD

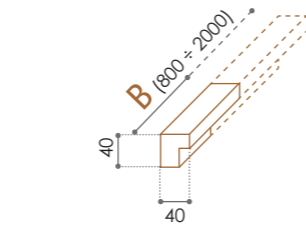

Bordo salva acqua Water save rail

Bordo salva acqua con finitura oro fornito su richiesta. Il bordo viene fornito già montato dietro disegno tecnico del cliente.
Water save rail with gold finish supplied upon request. In this case the rail will be supplied already assembled to the shower tray, behind customer technical drawing.

Sifone per piatti doccia a filo pavimento con foro scarico Ø90 mm.
Drain for shower tray with Ø 90 mm drain hole. Suitable for shower trays flush with the flooring.

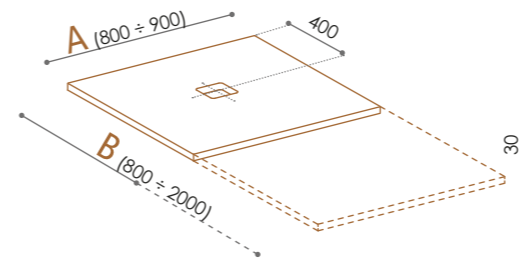
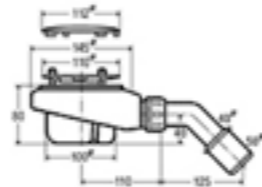

Piatti doccia Shower trays

B	A	A
	800 mm	900 mm
cm	cod.	cod.
80	SHW80X80SL	
90	SHW80X90SL	SHW90X90SL
100	SHW80X100SL	SHW90X100SL
110	SHW80X110SL	SHW90X110SL
120	SHW80X120SL	SHW90X120SL
130	SHW80X130SL	SHW90X130SL
140	SHW80X140SL	SHW90X140SL
150	SHW80X150SL	SHW90X150SL
160	SHW80X160SL	SHW90X160SL
170	SHW80X170SL	SHW90X170SL
180	SHW80X180SL	SHW90X180SL
190	SHW80X190SL	SHW90X190SL
200	SHW80X200SL	SHW90X200SL

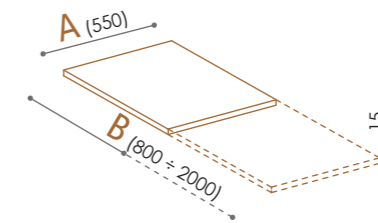

Rivestimenti Wall covering

B	A
	550 mm
cm	cod.
80	TLW55X80SL
90	TLW55X90SL
100	TLW55X100SL
110	TLW55X110SL
120	TLW55X120SL
130	TLW55X130SL
140	TLW55X140SL
150	TLW55X150SL
160	TLW55X160SL
170	TLW55X170SL
180	TLW55X180SL
190	TLW55X190SL
200	TLW55X200SL

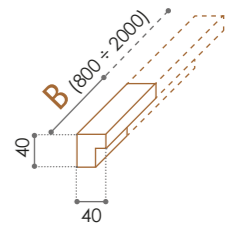

Bordo salva acqua Water save rail

Bordo salva acqua con finitura argento fornito su richiesta. Il bordo viene fornito già montato dietro disegno tecnico del cliente.
Water save rail with silver finish supplied upon request. In this case the rail will be supplied already assembled to the shower tray, behind customer technical drawing.

Sifone per piatti doccia a filo pavimento con foro scarico Ø90 mm.
Drain for shower tray with Ø 90 mm drain hole. Suitable for shower trays flush with the flooring.

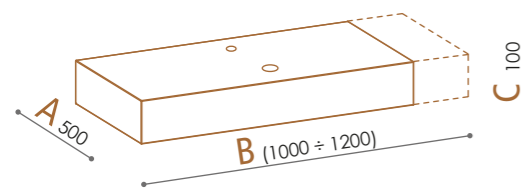
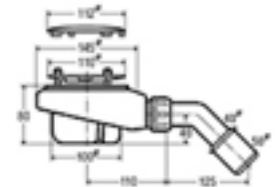

Top

B	B
1000 mm	1200 mm
cod.	cod.
TOPW100X50GD	TOPW120X50GD

Il top viene fornito con fori per lavabo e rubinetto come indicato sul disegno. Su richiesta sono realizzabili diametri e disposizioni diversi.

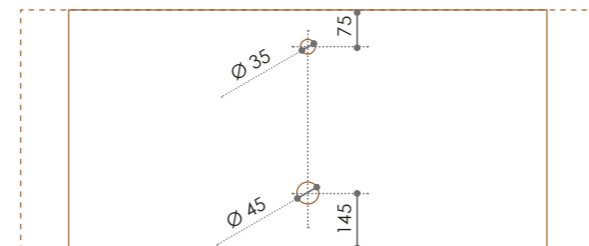

The top is supplied with pre-drilled holes as shown on the drawing. Upon request, holes can be supplied according to customer requirements.

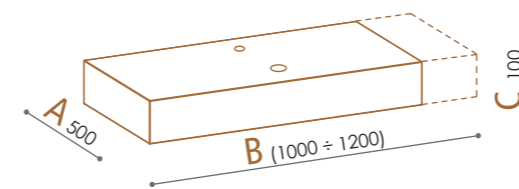

Top

B	B
1000 mm	1200 mm
cod.	cod.
TOPW100X50SL	TOPW120X50SL

Il top viene fornito con fori per lavabo e rubinetto come indicato sul disegno. Su richiesta sono realizzabili diametri e disposizioni diversi.

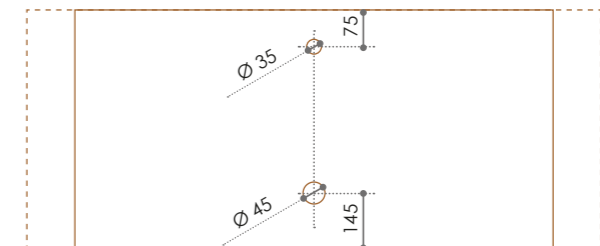

The top is supplied with pre-drilled holes as shown on the drawing. Upon request, holes can be supplied according to customer requirements.



I Top sono compatibili con tutta la gamma di lavabi Glass Design.
The tops are suitable with the full range of Glass Design washbasins.

Laguna



Ø foro / hole = 45 mm
peso / weight = 4,70 kg

Base anello cromata e piletta inclusi
Chrome plug and chrome ring basement included

code:



night
LAGUNAT33



smoke
LAGUNAT43



red
LAGUNAT16



blue
LAGUNAT42

Il fascino di una
TERRA
pregiata

The fascination of precious ground

La serie TERRA LUX comprende piatti doccia, top per lavabi e lastre di rivestimento per garantire la massima coordinabilità.

Realizzati in Teknoform®, il materiale delle texture a rilievo, vi doneranno la vera essenza della pietra.

Il composto di resine termoindurenti, cariche di minerali naturali, è impregniato con smalti in oro o argento e trasformano il prodotto in un vero e proprio oggetto d'arredo.

The TERRA LUX collection includes shower trays, tops and wall-covering files, all designed to match the full product range.

TERRA LUX is finished in our Teknoform® texture relief material, lending the collection the true essence of stone. The special composition of resins mixed with mineral fillers is enriched with precious gold and silver enamels, creating a true furnishing object.

TERRA LUX

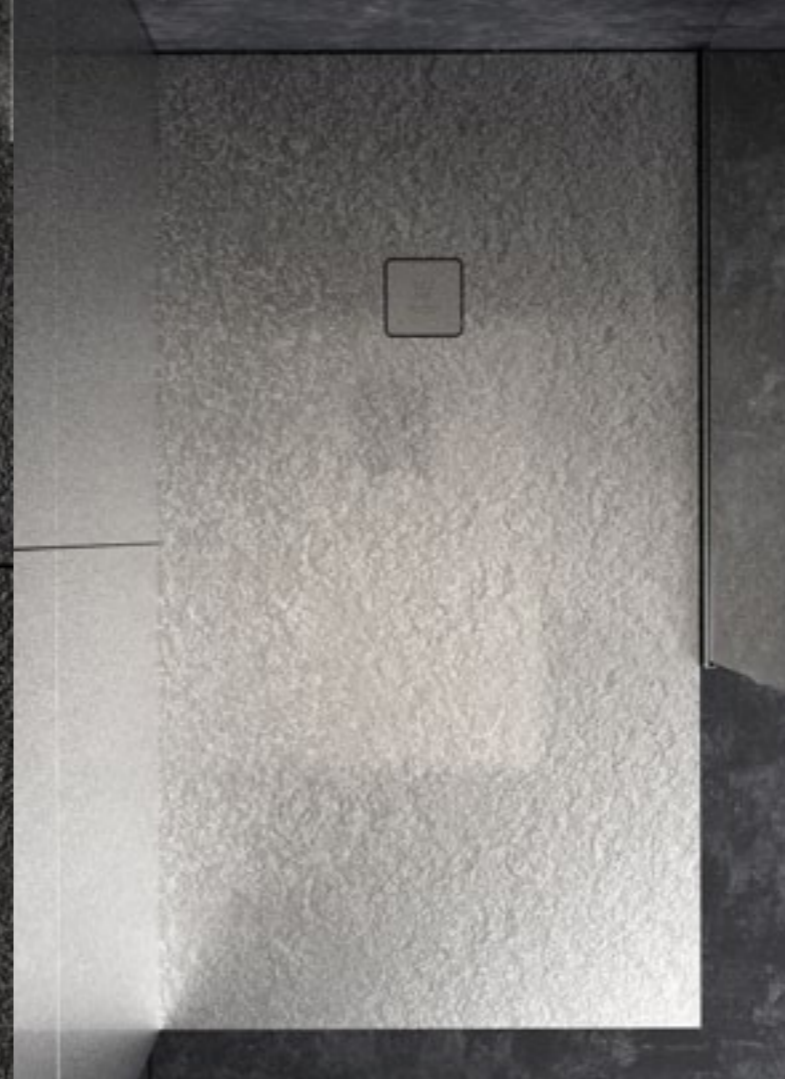

TERRA LUX SILVER

Texture pietra a rilievo con smalto argento su avorio

- **PIATTI DOCCIA**
Oltre alla loro eleganza ed originalità stilistica, i piatti doccia si distinguono per la loro flessibilità di posa e l'ampio assortimento dimensionale che va da 80 cm fino ai 200 cm. Grazie allo spessore ridotto di soli 3 cm, il piatto doccia può essere installato filo pavimento o in appoggio. Ogni piatto doccia è provvisto di griglia in acciaio inox.

- **LASTRE DI RIVESTIMENTO**
Le lastre di rivestimento sono il complemento ideale per il piatto doccia. La loro lunghezza segue quella dei piatti doccia che va da 80 cm fino a 200 cm con un'altezza di 55cm.

Stone relief texture with silver enamel on ivory colour base.

- **SHOWER TRAYS**
In addition to their elegance and originality of style, the shower trays are distinguished by their flexibility of installation and dimensions ranging from 80cm to 200cm. Thanks to the reduced thickness of only 3cm, the shower tray can be installed either on top or flush with the flooring. Each shower tray is supplied with a stainless steel drain.

- **WALL COVERING TILES**
Wall covering tiles are the perfect complement to the shower tray. Their sizes follow those of the shower trays with a length ranging from 80 cm to 200 cm and a height of 55 cm.

FLESSIBILITÀ DI POSA - GREATEST FLEXIBILITY ON INSTALLATION

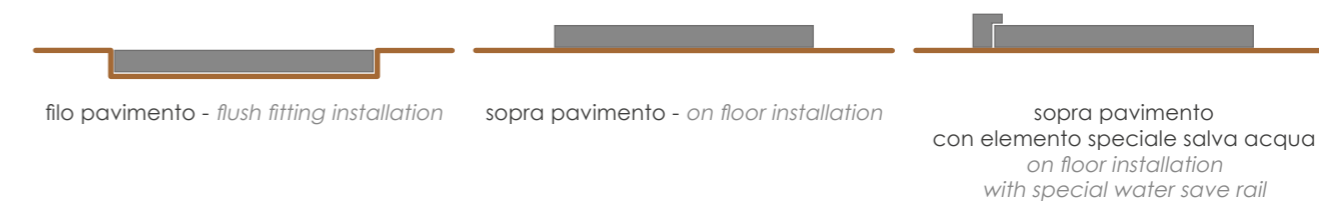

In foto/on photo
Lastre di rivestimento in Terra lux argento/avorio. Dim. 80x55 cm
Wall covering tiles Terra lux silver/ivory. Size 80x55 cm
code TLS55X80SL

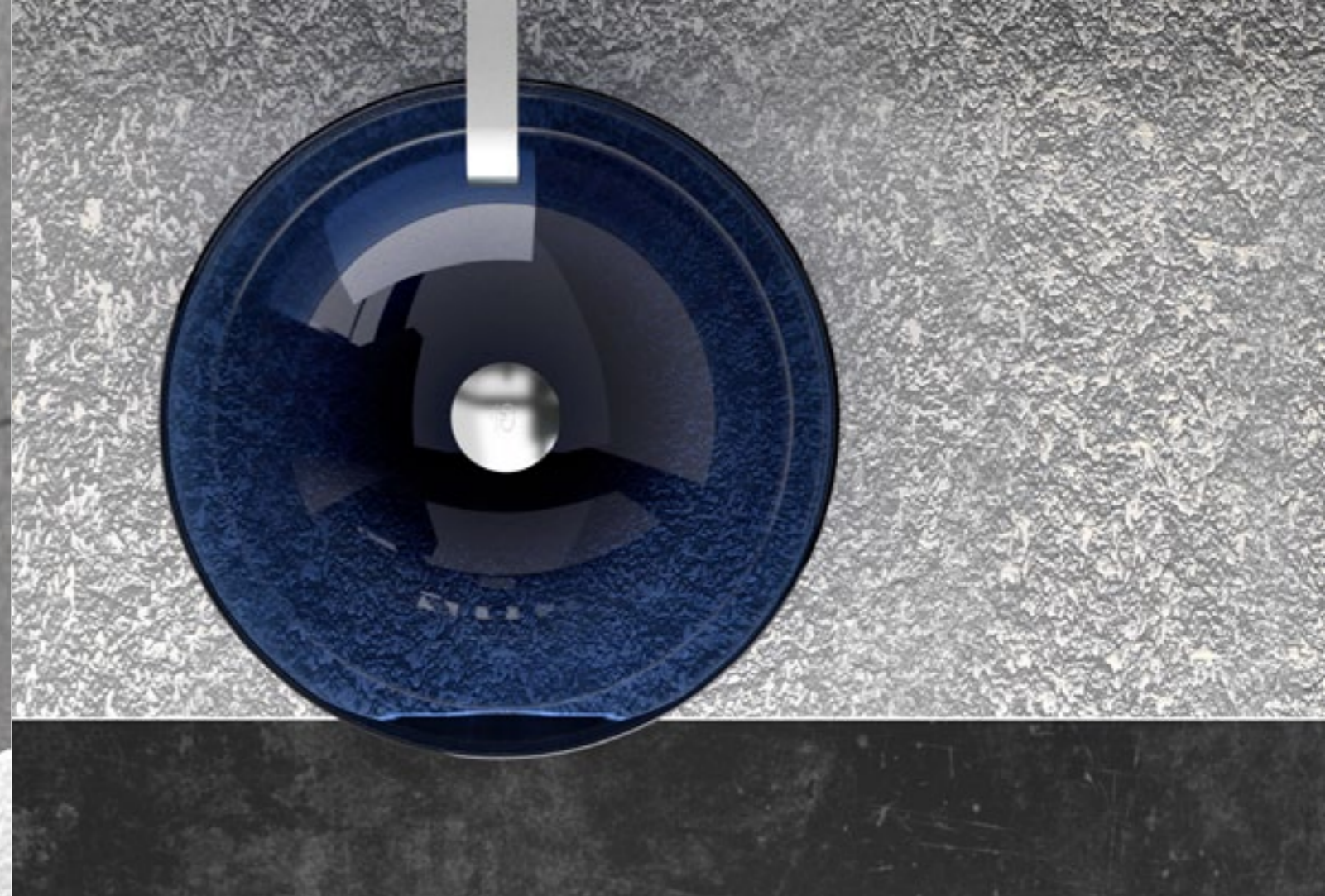

TERRA LUX SILVER

Texture pietra a rilievo con smalto argento su avorio

- TOP
Il piano lavabo è realizzato in Teknoform®, con texture pietra a rilievo. Disponibile in 2 misure: L 100/120 x 50 x H 10 cm.

- LAVABO LAGUNA
Lavabo da appoggio in vetro di Murano fornito con piletta e anello cromati.

Stone relief texture with silver enamel on ivory colour base.

- TOP
The Top is produced in Teknoform® with stone relief texture. Available in 2 sizes: W100/120 x 50 x H 10 cm.

- LAGUNA WASHBASIN
Counter top washbasin in Murano glass supplied with chrome waste and base ring.

FLESSIBILITÀ DI INSTALLAZIONE - GREATEST FLEXIBILITY ON INSTALLATION



In foto/on photo
Top Terra Lux argento/avorio. Dim. 100x50x10 cm
Top Terra lux silver/ivory. Size 100x50x10 cm
code TOPS100X50SL

Lavabo Laguna Blue in Vetro di Murano Dim. Ø41cm h 17,5 cm
Washbasin Laguna Blue Murano Glass. Size. Ø41cm h 17,5 cm
code: LAGUNAT42

TERRA LUX GOLD

Texture pietra a rilievo con smalto oro su avorio.

- PIATTI DOCCIA

Oltre alla loro eleganza ed originalità stilistica, i piatti doccia si distinguono per la loro flessibilità di posa e l'ampio assortimento dimensionale che va da 80 cm fino ai 200 cm. Grazie allo spessore ridotto di soli 3 cm, il piatto doccia può essere installato filo pavimento o in appoggio. Ogni piatto doccia è provvisto di griglia in acciaio inox.

- LASTRE DI RIVESTIMENTO

Le lastre di rivestimento sono il complemento ideale per il piatto doccia. La loro lunghezza segue quella dei piatti doccia che va da 80 cm fino a 200 cm con un'altezza di 55cm.

- TOP

Il piano lavabo è realizzato in Teknoform®, con texture pietra a rilievo. Disponibile in 2 misure: L100/120 x 50 x H 10 cm.

- LAVABO LAGUNA

lavabo da appoggio in vetro di Murano fornito con piletta e anello cromati.

Stone relief texture with gold enamel on ivory colour base.

- SHOWER TRAYS

In addition to their elegance and originality of style, the shower trays are distinguished by their flexibility of installation and dimensions ranging from 80cm to 200cm. Thanks to the reduced thickness of only 3cm, the shower tray can be installed either on top or flush with the flooring. Each shower tray is supplied with a stainless steel drain.

- WALL COVERING TILES

Wall covering tiles are the perfect complement to the shower tray. Their sizes follow those of the shower trays with a length ranging from 80 cm to 200 cm and a height of 55 cm.

- TOP

The Top is produced in Teknoform®, with stone relief texture. Available in two sizes: W 100/120 x 50 x H 10 cm.

- LAGUNA WASHBASIN

Counter top washbasin in Murano glass supplied with chrome waste and base ring.

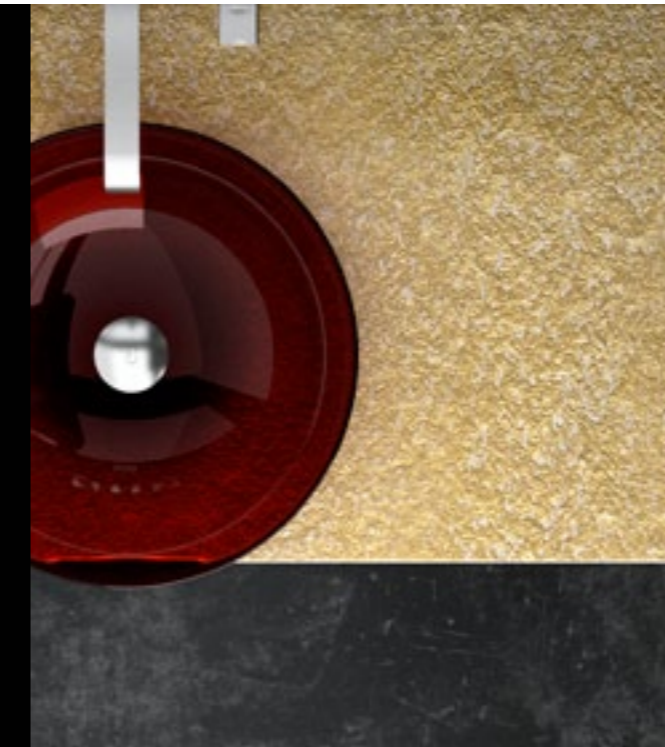

FLESSIBILITÀ DI POSA - GREATEST FLEXIBILITY ON INSTALLATION

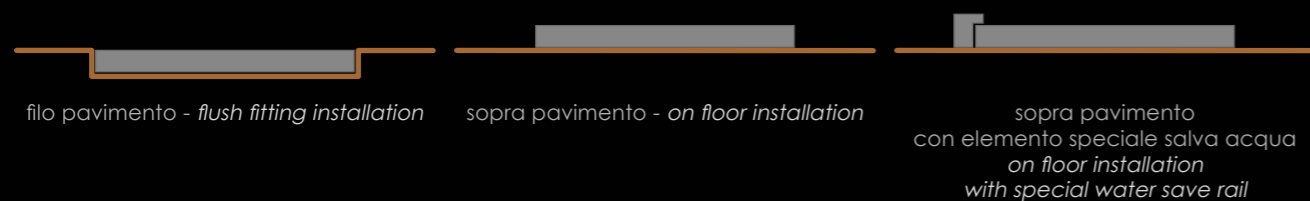

FLESSIBILITÀ DI INSTALLAZIONE - GREATEST FLEXIBILITY ON INSTALLATION



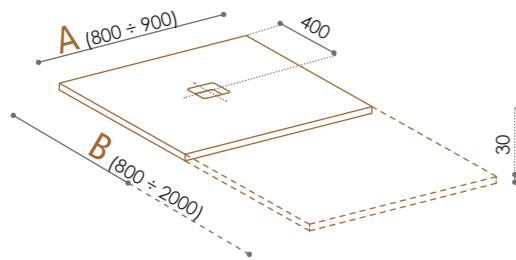

Piatti doccia Shower trays

B	A	A
	800 mm	900 mm
cm	cod.	cod.
80	SHS80X80GD	
90	SHS80X90GD	SHS90X90GD
100	SHS80X100GD	SHS90X100GD
110	SHS80X110GD	SHS90X110GD
120	SHS80X120GD	SHS90X120GD
130	SHS80X130GD	SHS90X130GD
140	SHS80X140GD	SHS90X140GD
150	SHS80X150GD	SHS90X150GD
160	SHS80X160GD	SHS90X160GD
170	SHS80X170GD	SHS90X170GD
180	SHS80X180GD	SHS90X180GD
190	SHS80X190GD	SHS90X190GD
200	SHS80X200GD	SHS90X200GD

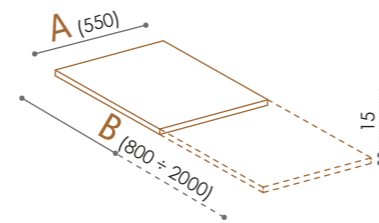

Rivestimenti Wall covering

B	A
	550 mm
cm	cod.
80	TLS55X80GD
90	TLS55X90GD
100	TLS55X100GD
110	TLS55X110GD
120	TLS55X120GD
130	TLS55X130GD
140	TLS55X140GD
150	TLS55X150GD
160	TLS55X160GD
170	TLS55X170GD
180	TLS55X180GD
190	TLS55X190GD
200	TLS55X200GD

Bordo salva acqua Water save rail

Bordo salva acqua con finitura oro fornito su richiesta. Il bordo viene fornito già montato dietro disegno tecnico del cliente.
Water save rail with gold finish supplied upon request. In this case the rail will be supplied already assembled to the shower tray, behind customer technical drawing.

Sifone per piatti doccia a filo pavimento con foro scarico Ø90 mm.
Drain for shower tray with Ø 90 mm drain hole. Suitable for shower trays flush with the flooring.

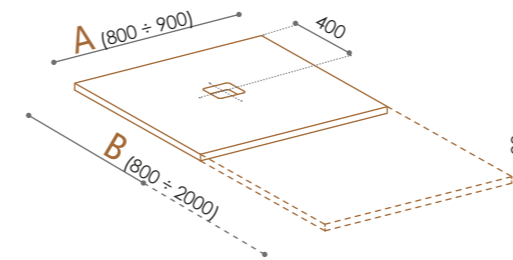
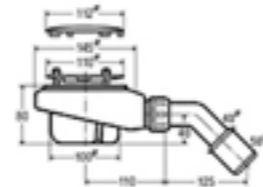

Piatti doccia Shower trays

B	A	A
	800 mm	900 mm
cm	cod.	cod.
80	SHS80X80SL	
90	SHS80X90SL	SHS90X90SL
100	SHS80X100SL	SHS90X100SL
110	SHS80X110SL	SHS90X110SL
120	SHS80X120SL	SHS90X120SL
130	SHS80X130SL	SHS90X130SL
140	SHS80X140SL	SHS90X140SL
150	SHS80X150SL	SHS90X150SL
160	SHS80X160SL	SHS90X160SL
170	SHS80X170SL	SHS90X170SL
180	SHS80X180SL	SHS90X180SL
190	SHS80X190SL	SHS90X190SL
200	SHS80X200SL	SHS90X200SL

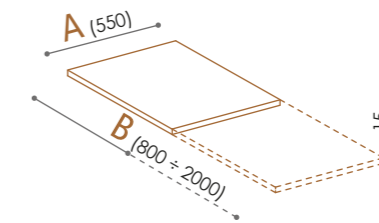

Rivestimenti Wall covering

B	A
	550 mm
cm	cod.
80	TLS55X80SL
90	TLS55X90SL
100	TLS55X100SL
110	TLS55X110SL
120	TLS55X120SL
130	TLS55X130SL
140	TLS55X140SL
150	TLS55X150SL
160	TLS55X160SL
170	TLS55X170SL
180	TLS55X180SL
190	TLS55X190SL
200	TLS55X200SL

Bordo salva acqua Water save rail

Bordo salva acqua con finitura argento fornito su richiesta. Il bordo viene fornito già montato dietro disegno tecnico del cliente.
Water save rail with silver finish supplied upon request. In this case the rail will be supplied already assembled to the shower tray, behind customer technical drawing.

Sifone per piatti doccia a filo pavimento con foro scarico Ø90 mm.
Drain for shower tray with Ø 90 mm drain hole. Suitable for shower trays flush with the flooring.

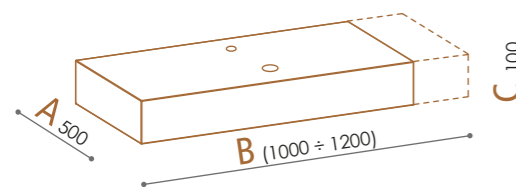
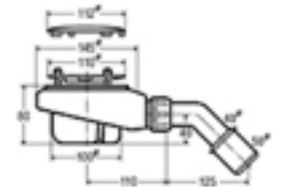

Top

B	B
1000 mm	1200 mm
cod.	cod.
TOPS100X50GD	TOPS120X50GD

Il top viene fornito con fori per lavabo e rubinetto come indicato sul disegno. Su richiesta sono realizzabili diametri e disposizioni diversi.

The top is supplied with pre-drilled holes as shown on the drawing. Upon request, holes can be supplied according to customer requirements.

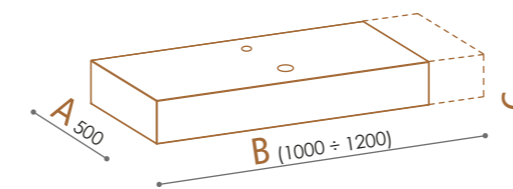
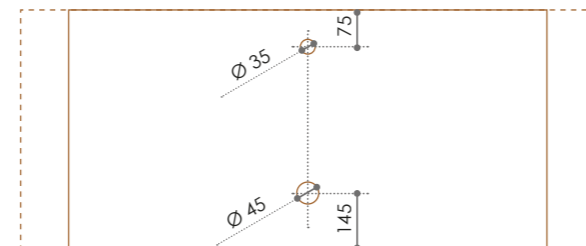

Top

B	B
1000 mm	1200 mm
cod.	cod.
TOPS100X50SL	TOPS120X50SL

Il top viene fornito con fori per lavabo e rubinetto come indicato sul disegno. Su richiesta sono realizzabili diametri e disposizioni diversi.

The top is supplied with pre-drilled holes as shown on the drawing. Upon request, holes can be supplied according to customer requirements.

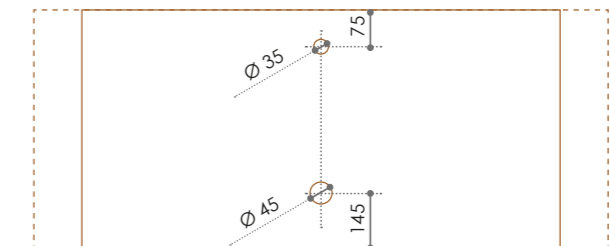

I Top sono compatibili con tutta la gamma di lavabi Glass Design.
The tops are suitable with the full range of Glass Design washbasins.

Laguna



Ø foro / hole = 45 mm
peso / weight = 4,70 kg

Base anello cromata e piletta inclusi
Chrome plug and chrome ring basement included

code:



night
LAGUNAT33



smoke
LAGUNAT43



red
LAGUNAT16



blue
LAGUNAT42

The background of the entire image is a dark, rich brown wood grain. The grain pattern is wavy and organic, with various knots and swirls visible. The lighting is subtle, highlighting the texture of the wood.

L'essenza
NATURALE
del legno

The natural essence of wood

La serie Natura comprende piatti doccia, top per lavabi e lastre di rivestimento per garantire la massima coordinabilità. Realizzati in Teknoform®, il materiale delle texture a rilievo, vi doneranno la vera essenza del legno. Il composto di resine termoindurenti, cariche di minerali naturali, trasformano il prodotto in un vero e proprio oggetto d'arredo.

The NATURA collection includes shower trays, tops and wall-covering tiles, all designed to match the full product range.

NATURA is finished in our Teknoform® texture relief material, lending the collection the true essence of wood. The special composition of resins mixed with mineral fillers lets the product become a true furnishing object.

NATURA



In foto/on photo
 Piatto doccia Natura wengé . Dim. 180x90x3 cm
 Shower tray Natura wengé . Size 180x90x3 cm
 code SHW90X180WG



NATURA WENGÉ

Texture legno a rilievo
 finitura wengé.

- **PIATTI DOCCIA**
 Oltre alla loro eleganza ed originalità stilistica, i piatti doccia si distinguono per la loro flessibilità di posa e l'ampio assortimento dimensionale che va da 80 cm fino ai 200 cm. Grazie allo spessore ridotto di soli 3 cm, il piatto doccia può essere installato filo pavimento o in appoggio. Ogni piatto doccia è provvisto di griglia in acciaio inox.
- **LASTRE DI RIVESTIMENTO**
 Le lastre di rivestimento sono il complemento ideale per il piatto doccia. La loro lunghezza segue quella dei piatti doccia che va da 80 cm fino a 200 cm con un'altezza di 55 cm.

Wood relief texture wengé finish

- **SHOWER TRAYS**
 In addition to their elegance and originality of style, the shower trays are distinguished by their flexibility of installation and dimensions ranging from 80cm to 200cm. Thanks to the reduced thickness of only 3cm, the shower tray can be installed either on top or flush with the flooring. Each shower tray is supplied with a stainless steel drain.
- **WALL COVERING TILES**
 Wall covering tiles are the perfect complement to the shower tray. Their sizes follow those of the shower trays with a length ranging from 80 cm to 200 cm and a height of 55 cm.

FLESSIBILITÀ DI POSA - GREATEST FLEXIBILITY ON INSTALLATION

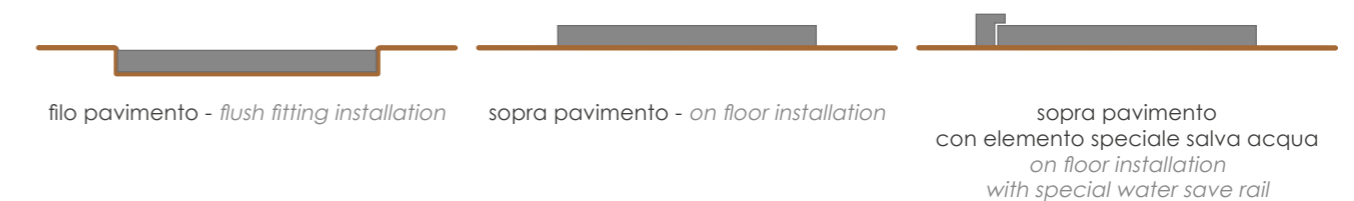



NATURA WENGÉ

Texture legno a rilievo
finitura wengé.

• TOP
Il piano lavabo è realizzato in Teknoform®,
con texture legno a rilievo.
Disponibile in 2 misure: L 100/120 x 50 x H 10 cm.

• LAVABO LAGUNA
Lavabo da appoggio in vetro di Murano fornito con piletta e
anello cromati.

Wood relief texture wengé finish

• TOP
The Top is produced in Teknoform® with wood relief texture.
Available in 2 sizes: W 100/120 x 50 x H 10 cm.

• LAGUNA WASHBASIN
Counter top washbasin in Murano glass supplied with chrome
waste and base ring.

FLESSIBILITÀ DI INSTALLAZIONE - GREATEST FLEXIBILITY ON INSTALLATION



In foto on photo
Top Natura wengé. Dim. 120x50x10 cm
Top Natura wengé. Size 120x50x10 cm
code: TOPW120X50WG

Lavabo Laguna Smoke in Vetro di Murano' Dim. Ø41cm h 17,5 cm
Washbasin Laguna Smoke Murano Glass. Size. Ø41cm h 17,5 cm
code: LAGUNAT43

NATURA ROVERE

Texture legno a rilievo finitura rovere.

- PIATTI DOCCIA

Oltre alla loro eleganza ed originalità stilistica, i piatti doccia si distinguono per la loro flessibilità di posa e l'ampio assortimento dimensionale che va da 80 cm fino ai 200 cm. Grazie allo spessore ridotto di soli 3 cm, il piatto doccia può essere installato filo pavimento o in appoggio. Ogni piatto doccia è provvisto di griglia in acciaio inox.

- LASTRE DI RIVESTIMENTO

Le lastre di rivestimento sono il complemento ideale per il piatto doccia. La loro lunghezza segue quella dei piatti doccia che va da 80 cm fino a 200 cm con un'altezza di 55cm.

- TOP

Il piano lavabo è realizzato in Teknoform®, con texture legno a rilievo. Disponibile in 2 misure: L 100/120 x 50 x H 10 cm.

- LAVABO LAGUNA

lavabo da appoggio in vetro di Murano fornito con piletta e anello cromati.

Wood relief texture oak finish

- SHOWER TRAYS

In addition to their elegance and originality of style, the shower trays are distinguished by their flexibility of installation and dimensions ranging from 80cm to 200cm. Thanks to the reduced thickness of only 3cm, the shower tray can be installed either on top or flush with the flooring. Each shower tray is supplied with a stainless steel drain.

- WALL COVERING TILES

Wall covering tiles are the perfect complement to the shower tray. Their sizes follow those of the shower trays with a length ranging from 80 cm to 200 cm and a height of 55 cm.

- TOP

The Top is produced in Teknoform®, with wood relief texture. Available in two sizes: W 100/120 x 50 x H 10 cm.

- LAGUNA WASHBASIN

Counter top washbasin in Murano glass supplied with chrome waste and base ring.



FLESSIBILITÀ DI POSA - GREATEST FLEXIBILITY ON INSTALLATION

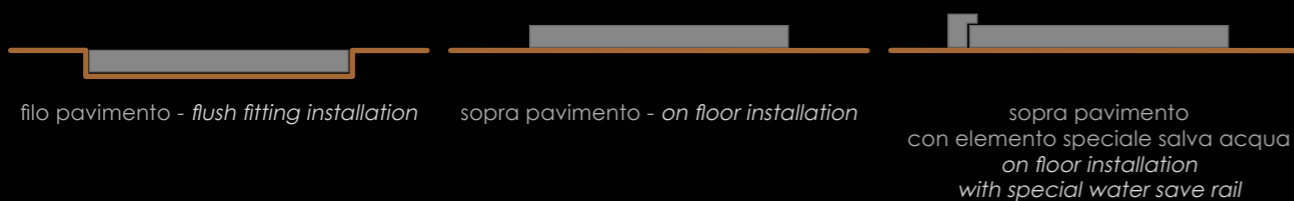

FLESSIBILITÀ DI INSTALLAZIONE - GREATEST FLEXIBILITY ON INSTALLATION



NATURA



WENGÉ



ROVERE

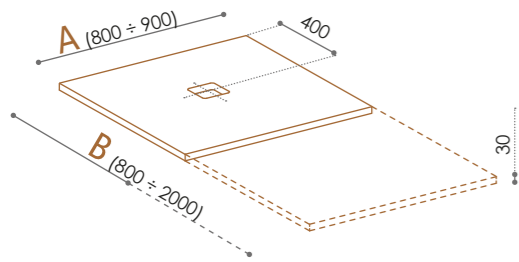

Piatti doccia Shower trays

B	A	A
	800 mm	900 mm
cm	cod.	cod.
80	SHW80X80WG	
90	SHW80X90WG	SHW90X90WG
100	SHW80X100WG	SHW90X100WG
110	SHW80X110WG	SHW90X110WG
120	SHW80X120WG	SHW90X120WG
130	SHW80X130WG	SHW90X130WG
140	SHW80X140WG	SHW90X140WG
150	SHW80X150WG	SHW90X150WG
160	SHW80X160WG	SHW90X160WG
170	SHW80X170WG	SHW90X170WG
180	SHW80X180WG	SHW90X180WG
190	SHW80X190WG	SHW90X190WG
200	SHW80X200WG	SHW90X200WG

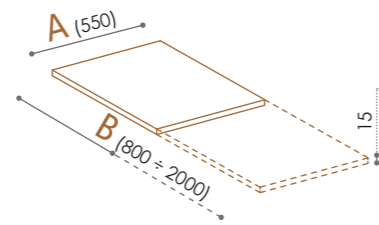

Rivestimenti Wall covering

B	A
	550 mm
cm	cod.
80	TLW55X80WG
90	TLW55X90WG
100	TLW55X100WG
110	TLW55X110WG
120	TLW55X120WG
130	TLW55X130WG
140	TLW55X140WG
150	TLW55X150WG
160	TLW55X160WG
170	TLW55X170WG
180	TLW55X180WG
190	TLW55X190WG
200	TLW55X200WG

Bordo salva acqua Water save rail

Bordo salva acqua con finitura wengé fornito su richiesta. Il bordo viene fornito già montato dietro disegno tecnico del cliente.
Water save rail with wengé finish supplied upon request. In this case the rail will be supplied already assembled to the shower tray, behind customer technical drawing.

Sifone per piatti doccia a filo pavimento con foro scarico Ø90 mm.
Drain for shower tray with Ø 90 mm drain hole. Suitable for shower trays flush with the flooring.

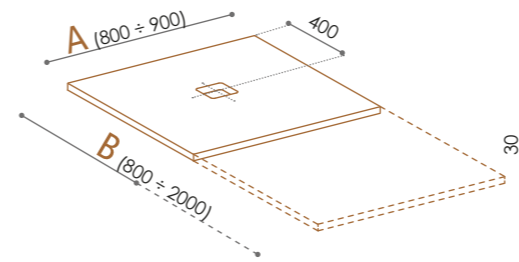
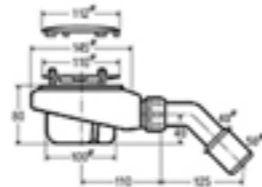

Piatti doccia Shower trays

B	A	A
	800 mm	900 mm
cm	cod.	cod.
80	SHW80X80RV	
90	SHW80X90RV	SHW90X90RV
100	SHW80X100RV	SHW90X100RV
110	SHW80X110RV	SHW90X110RV
120	SHW80X120RV	SHW90X120RV
130	SHW80X130RV	SHW90X130RV
140	SHW80X140RV	SHW90X140RV
150	SHW80X150RV	SHW90X150RV
160	SHW80X160RV	SHW90X160RV
170	SHW80X170RV	SHW90X170RV
180	SHW80X180RV	SHW90X180RV
190	SHW80X190RV	SHW90X190RV
200	SHW80X200RV	SHW90X200RV

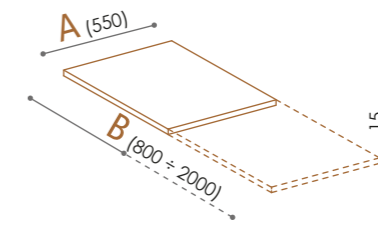

Rivestimenti Wall covering

B	A
	550 mm
cm	cod.
80	TLW55X80RV
90	TLW55X90RV
100	TLW55X100RV
110	TLW55X110RV
120	TLW55X120RV
130	TLW55X130RV
140	TLW55X140RV
150	TLW55X150RV
160	TLW55X160RV
170	TLW55X170RV
180	TLW55X180RV
190	TLW55X190RV
200	TLW55X200RV

Bordo salva acqua Water save rail

Bordo salva acqua con finitura rovere fornito su richiesta. Il bordo viene fornito già montato dietro disegno tecnico del cliente.
Water save rail with oak finish supplied upon request. In this case the rail will be supplied already assembled to the shower tray, behind customer technical drawing.

Sifone per piatti doccia a filo pavimento con foro scarico Ø90 mm.
Drain for shower tray with Ø 90 mm drain hole. Suitable for shower trays flush with the flooring.

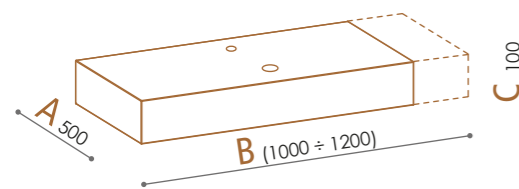
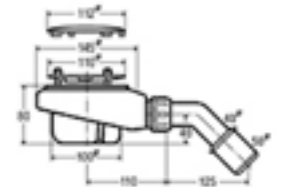

Top

B	B
1000 mm	1200 mm
cod.	cod.
TOPW100X50WG	TOPW120X50WG

Il top viene fornito con fori per lavabo e rubinetto come indicato sul disegno. Su richiesta sono realizzabili diametri e disposizioni diversi.

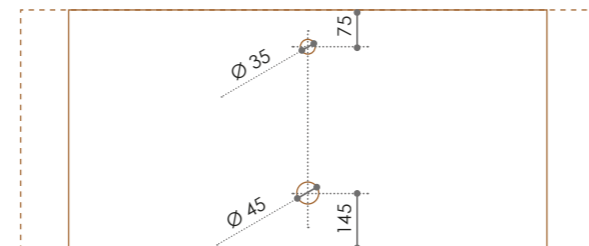

The top is supplied with pre-drilled holes as shown on the drawing. Upon request, holes can be supplied according to customer requirements.

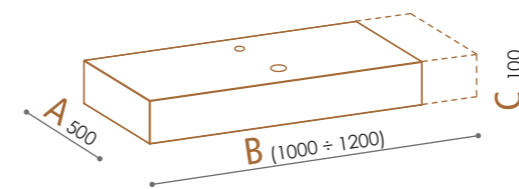

Top

B	B
1000 mm	1200 mm
cod.	cod.
TOPW100X50RV	TOPW120X50RV

Il top viene fornito con fori per lavabo e rubinetto come indicato sul disegno. Su richiesta sono realizzabili diametri e disposizioni diversi.

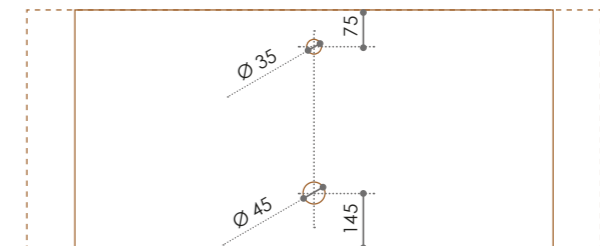

The top is supplied with pre-drilled holes as shown on the drawing. Upon request, holes can be supplied according to customer requirements.



I Top sono compatibili con tutta la gamma di lavabi Glass Design.
The tops are suitable with the full range of Glass Design washbasins.

Laguna



Ø foro / hole = 45 mm
peso / weight = 4,70 kg

Base anello cromata e piletta inclusi
Chrome plug and chrome ring basement included

code:



night
LAGUNAT33



smoke
LAGUNAT43



red
LAGUNAT16



blue
LAGUNAT42

La piacevole
sensazione della
TERRA

Sensational feelings with the ground



DV 224

La serie Terra comprende piatti doccia, top per lavabi e lastre di rivestimento per garantire la massima coordinabilità. Realizzati in Teknoform®, il materiale delle texture a rilievo, vi doneranno la vera essenza della pietra.

Il composto di resine termoindurenti, cariche di minerali naturali, trasformano il prodotto in un vero e proprio oggetto d'arredo.

The TERRA collection includes shower trays, tops and wall-covering tiles, all designed to match the full product range.

TERRA is finished in our Teknoform® texture relief material, lending the collection the true essence of stone. The special composition of resins mixed with mineral fillers lets the product become a true furnishing object.



225 DV

TERRA



In foto/on photo
 Piatto doccia Terra bianco. Dim. 200x90x3 cm Shower tray Terra white. Size 200x90x3 cm. code: SHS90X200PO01
 Lastre di rivestimento Terra bianco 90x55 cm Wall covering tiles Terra white 90x55 cm. code: TLS55X90PO01



TERRA BIANCO

Texture pietra a rilievo finitura bianco.

Stone relief texture white finish.

- **PIATTI DOCCIA**
 Oltre alla loro eleganza ed originalità stilistica, i piatti doccia si distinguono per la loro flessibilità di posa e l'ampio assortimento dimensionale che va da 80 cm fino ai 200 cm. Grazie allo spessore ridotto di soli 3 cm, il piatto doccia può essere installato filo pavimento o in appoggio. Ogni piatto doccia è provvisto di griglia in acciaio inox.

- **SHOWER TRAYS**
In addition to their elegance and originality of style, the shower trays are distinguished by their flexibility of installation and dimensions ranging from 80cm to 200cm. Thanks to the reduced thickness of only 3cm, the shower tray can be installed either on top or flush with the flooring. Each shower tray is supplied with a stainless steel drain.

- **LASTRE DI RIVESTIMENTO**
 Le lastre di rivestimento sono il complemento ideale per il piatto doccia. La loro lunghezza segue quella dei piatti doccia che va da 80 cm fino a 200 cm con un'altezza di 55 cm.

- **WALL COVERING TILES**
Wall covering tiles are the perfect complement to the shower tray. Their sizes follow those of the shower trays with a length ranging from 80 cm to 200 cm and a height of 55 cm.

FLESSIBILITÀ DI POSA - GREATEST FLEXIBILITY ON INSTALLATION

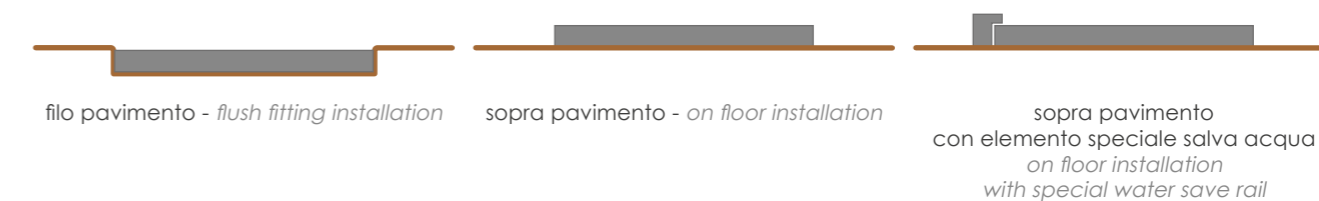



In foto/on photo
 Top Terra bianco. Dim. 120x50x10 cm
 Top Terra white. Size 120x50x10 cm
 Code TOPS120X50P001

Lavabo Laguna Night in Vetro di Murano. Dim. Ø41cm h 17,5 cm
 Washbasin Laguna Night Murano Glass. Size. Ø41cm h 17,5 cm
 code: LAGUNAT33

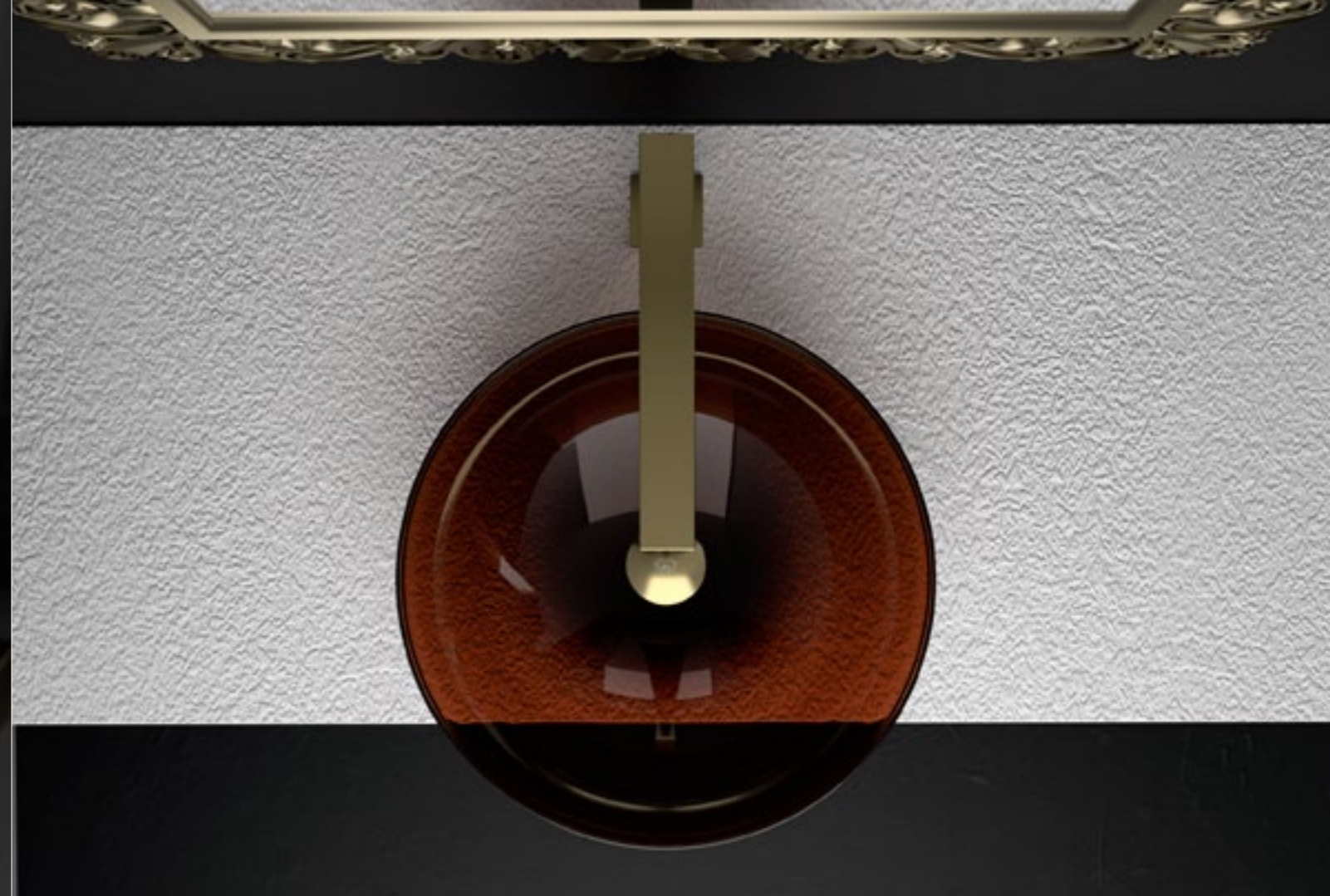

TERRA BIANCO

Texture pietra a rilievo finitura bianco.

- TOP
 Il piano lavabo è realizzato in Teknoform®, con texture pietra a rilievo.
 Disponibile in 2 misure: L 100/120 x 50 x H 10 cm.
- LAVABO LAGUNA
 Lavabo da appoggio in vetro di Murano fornito con piletta e anello cromati.

Stone relief texture white finish.

- TOP
 The Top is produced in Teknoform® with stone relief texture.
 Available in 2 sizes: W 100/120 x 50 x H 10 cm.
- LAGUNA WASHBASIN
 Counter top washbasin in Murano glass supplied with chrome waste and base ring.

FLESSIBILITÀ DI INSTALLAZIONE - GREATEST FLEXIBILITY ON INSTALLATION



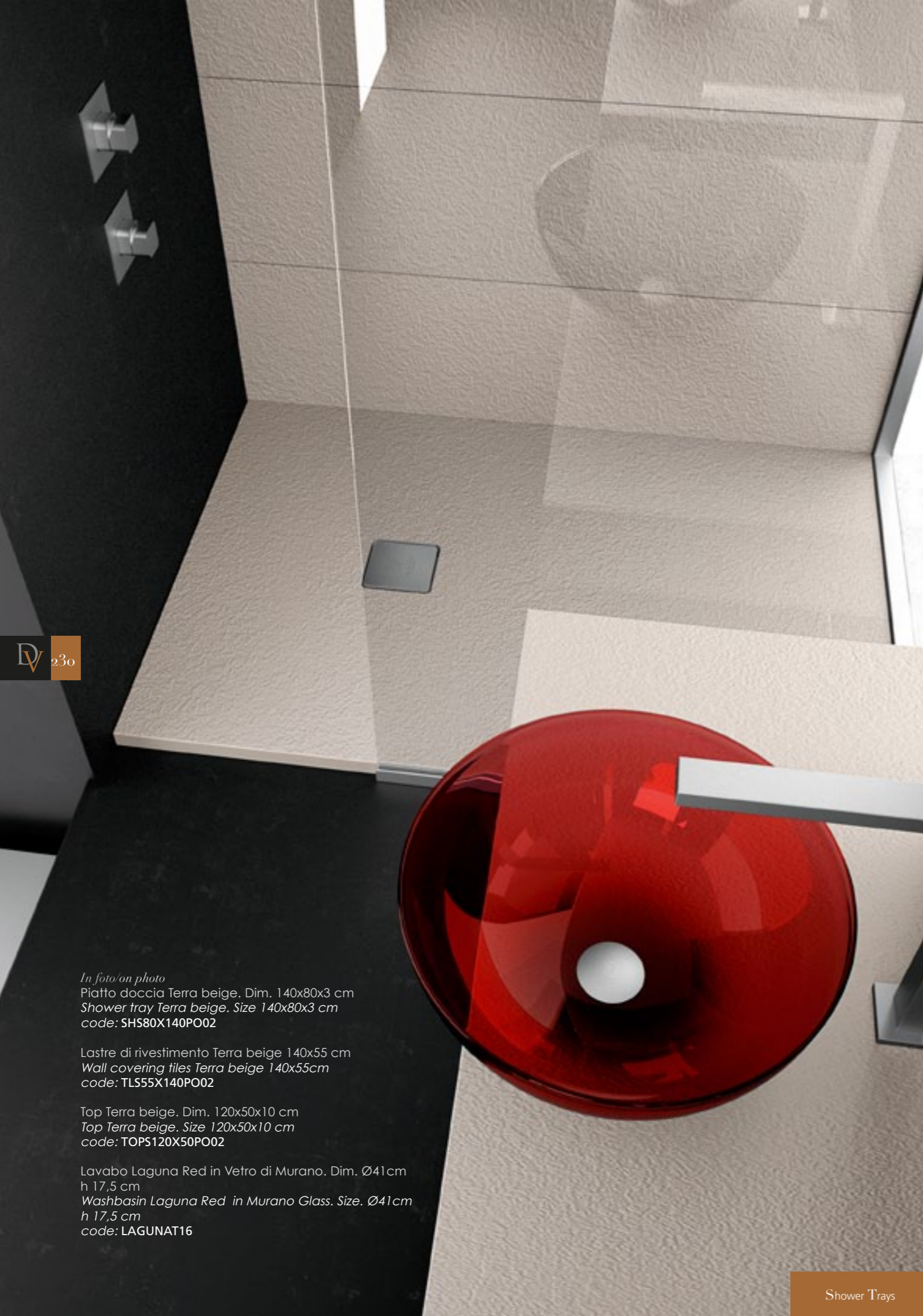

In foto/on photo

Piatto doccia Terra beige. Dim. 140x80x3 cm
Shower tray Terra beige. Size 140x80x3 cm
code: SHS80X140PO02

Lastre di rivestimento Terra beige 140x55 cm
Wall covering tiles Terra beige 140x55cm
code: TLS55X140PO02

Top Terra beige. Dim. 120x50x10 cm
Top Terra beige. Size 120x50x10 cm
code: TOPS120X50PO02

Lavabo Laguna Red in Vetro di Murano. Dim. Ø41 cm
h 17,5 cm
Washbasin Laguna Red in Murano Glass. Size. Ø41 cm
h 17,5 cm
code: LAGUNAT16



TERRA BEIGE

Texture pietra a rilievo finitura beige.

- **PIATTI DOCCIA**
Oltre alla loro eleganza ed originalità stilistica, i piatti doccia si distinguono per la loro flessibilità di posa e l'ampio assortimento dimensionale che va da 80 cm fino ai 200 cm. Grazie allo spessore ridotto di soli 3 cm, il piatto doccia può essere installato filo pavimento o in appoggio. Ogni piatto doccia è provvisto di griglia in acciaio inox.

- **LASTRE DI RIVESTIMENTO**
Le lastre di rivestimento sono il complemento ideale per il piatto doccia. La loro lunghezza segue quella dei piatti doccia che va da 80 cm fino a 200 cm con un'altezza di 55cm.

- **TOP**
Il piano lavabo è realizzato in Teknoform®, con texture pietra a rilievo. Disponibile in 2 misure: L 100/120 x 50 x H 10 cm.

- **LAVABO LAGUNA**
Lavabo da appoggio in vetro di Murano fornito con piletta e anello cromati.

Stone relief texture beige finish.

- **SHOWER TRAYS**
In addition to their elegance and originality of style, the shower trays are distinguished by their flexibility of installation and dimensions ranging from 80cm to 200cm. Thanks to the reduced thickness of only 3cm, the shower tray can be installed either on top or flush with the flooring. Each shower tray is supplied with a stainless steel drain.

- **WALL COVERING TILES**
Wall covering tiles are the perfect complement to the shower tray. Their sizes follow those of the shower trays with a length ranging from 80 cm to 200 cm and a height of 55 cm.

- **TOP**
The Top is produced in Teknoform® with stone relief texture. Available in 2 sizes: W 100/120 x 50 x H 10 cm.

- **LAGUNA WASHBASIN**
Counter top washbasin in Murano glass supplied with chrome waste and base ring.

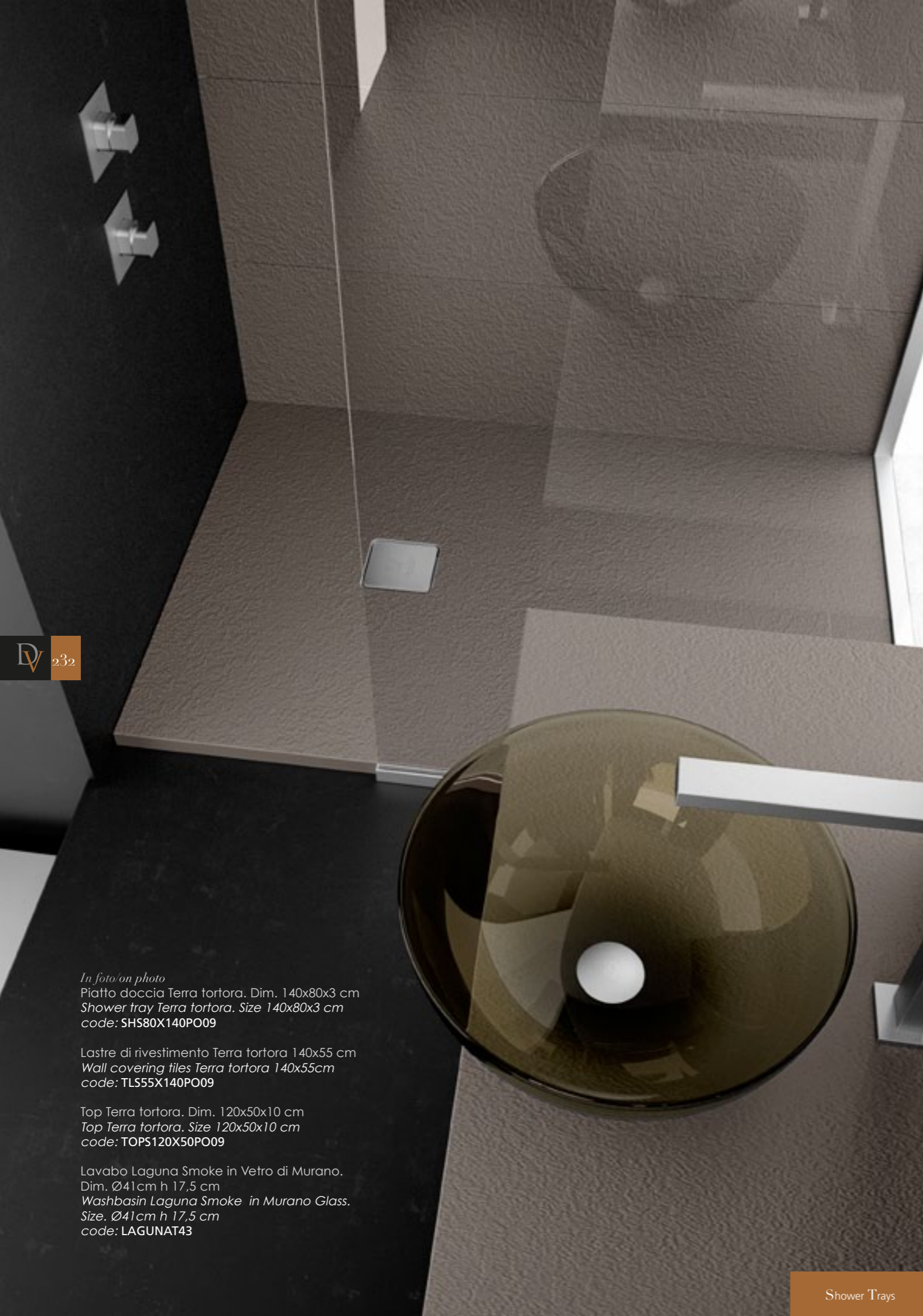

In foto/on photo

Piatto doccia Terra tortora. Dim. 140x80x3 cm
Shower tray Terra tortora. Size 140x80x3 cm
code: SHS80X140PO09

Lastre di rivestimento Terra tortora 140x55 cm
Wall covering tiles Terra tortora 140x55cm
code: TLS55X140PO09

Top Terra tortora. Dim. 120x50x10 cm
Top Terra tortora. Size 120x50x10 cm
code: TOPS120X50PO09

Lavabo Laguna Smoke in Vetro di Murano.
Dim. Ø41cm h 17,5 cm
Washbasin Laguna Smoke in Murano Glass.
Size. Ø41cm h 17,5 cm
code: LAGUNAT43



TERRA TORTORA

Texture pietra a rilievo finitura tortora.

• **PIATTI DOCCIA**
Oltre alla loro eleganza ed originalità stilistica, i piatti doccia si distinguono per la loro flessibilità di posa e l'ampio assortimento dimensionale che va da 80 cm fino ai 200 cm. Grazie allo spessore ridotto di soli 3 cm, il piatto doccia può essere installato filo pavimento o in appoggio. Ogni piatto doccia è provvisto di griglia in acciaio inox.

• **LASTRE DI RIVESTIMENTO**
Le lastre di rivestimento sono il complemento ideale per il piatto doccia. La loro lunghezza segue quella dei piatti doccia che va da 80 cm fino a 200 cm con un'altezza di 55cm.

• **TOP**
Il piano lavabo è realizzato in Teknoform®, con texture pietra a rilievo. Disponibile in 2 misure: L 100/120 x 50 x H 10 cm.

• **LAVABO LAGUNA**
Lavabo da appoggio in vetro di Murano fornito con piletta e anello cromati.

Stone relief texture tortora finish.

• **SHOWER TRAYS**
In addition to their elegance and originality of style, the shower trays are distinguished by their flexibility of installation and dimensions ranging from 80cm to 200cm. Thanks to the reduced thickness of only 3cm, the shower tray can be installed either on top or flush with the flooring. Each shower tray is supplied with a stainless steel drain.

• **WALL COVERING TILES**
Wall covering tiles are the perfect complement to the shower tray. Their sizes follow those of the shower trays with a length ranging from 80 cm to 200 cm and a height of 55 cm.

• **TOP**
The Top is produced in Teknoform® with stone relief texture. Available in 2 sizes: W 100/120 x 50 x H 10 cm.

• **LAGUNA WASHBASIN**
Counter top washbasin in Murano glass supplied with chrome waste and base ring.

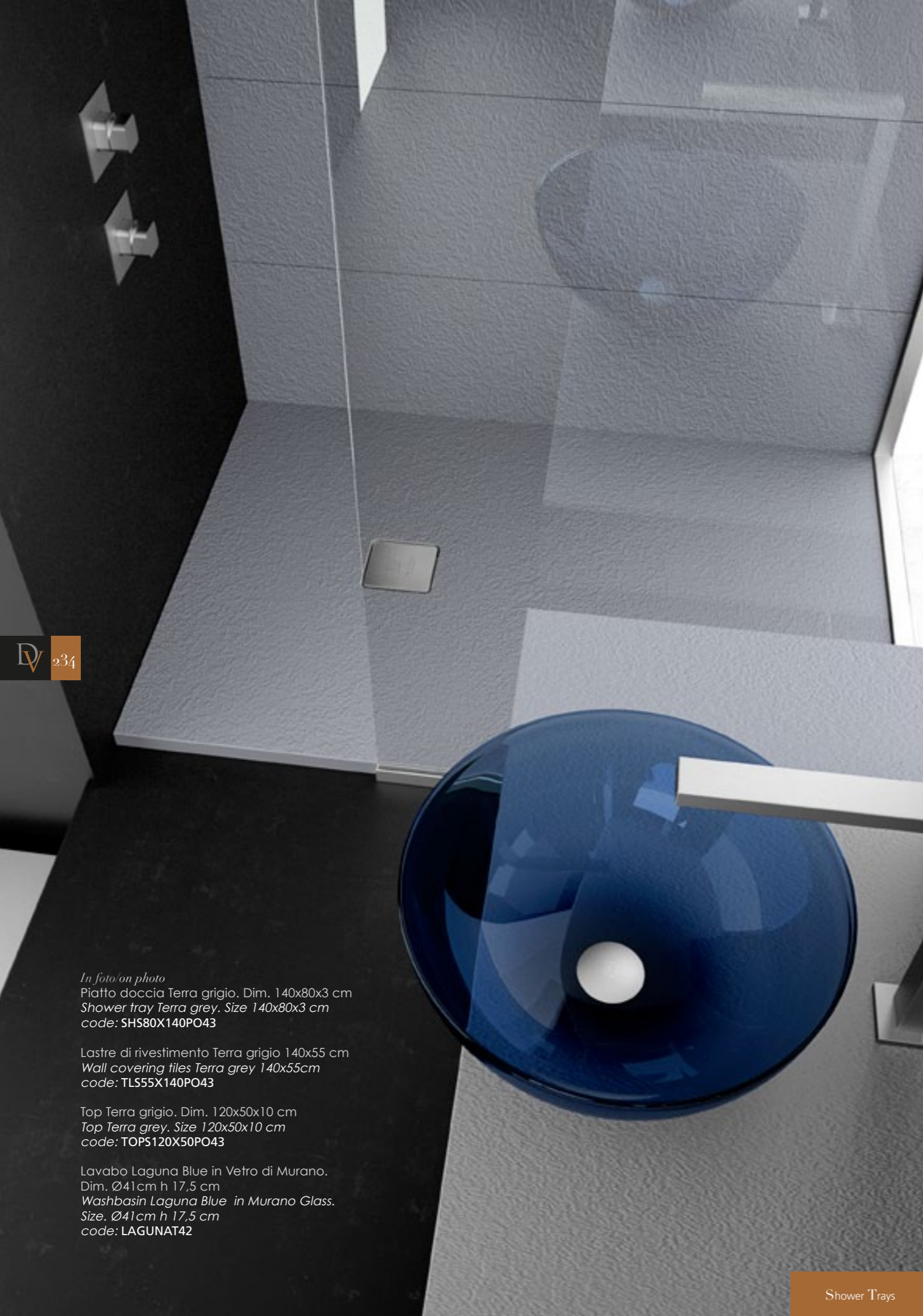

In foto/on photo
 Piatto doccia Terra grigio. Dim. 140x80x3 cm
 Shower tray Terra grey. Size 140x80x3 cm
 code: SHS80X140PO43

Lastre di rivestimento Terra grigio 140x55 cm
 Wall covering tiles Terra grey 140x55cm
 code: TLS55X140PO43

Top Terra grigio. Dim. 120x50x10 cm
 Top Terra grey. Size 120x50x10 cm
 code: TOPS120X50PO43

Lavabo Laguna Blue in Vetro di Murano.
 Dim. Ø41cm h 17,5 cm
 Washbasin Laguna Blue in Murano Glass.
 Size. Ø41cm h 17,5 cm
 code: LAGUNAT42

TERRA GRIGIO

Texture pietra a rilievo finitura grigio. *Stone relief texture grey finish.*

• PIATTI DOCCIA

Oltre alla loro eleganza ed originalità stilistica, i piatti doccia si distinguono per la loro flessibilità di posa e l'ampio assortimento dimensionale che va da 80 cm fino ai 200 cm. Grazie allo spessore ridotto di soli 3 cm, il piatto doccia può essere installato filo pavimento o in appoggio. Ogni piatto doccia è provvisto di griglia in acciaio inox.

• LASTRE DI RIVESTIMENTO

Le lastre di rivestimento sono il complemento ideale per il piatto doccia. La loro lunghezza segue quella dei piatti doccia che va da 80 cm fino a 200 cm con un'altezza di 55cm.

• TOP

Il piano lavabo è realizzato in Teknoform®, con texture pietra a rilievo. Disponibile in 2 misure: L 100/120 x 50 x H 10 cm.

• LAVABO LAGUNA

Lavabo da appoggio in vetro di Murano fornito con piletta e anello cromati.

• SHOWER TRAYS

In addition to their elegance and originality of style, the shower trays are distinguished by their flexibility of installation and dimensions ranging from 80cm to 200cm. Thanks to the reduced thickness of only 3cm, the shower tray can be installed either on top or flush with the flooring. Each shower tray is supplied with a stainless steel drain.

• WALL COVERING TILES

Wall covering tiles are the perfect complement to the shower tray. Their sizes follow those of the shower trays with a length ranging from 80 cm to 200 cm and a height of 55 cm.

• TOP

The Top is produced in Teknoform® with stone relief texture. Available in 2 sizes: W 100/120 x 50 x H 10 cm.

• LAGUNA WASHBASIN

Counter top washbasin in Murano glass supplied with chrome waste and base ring.

TERRA



BIANCO

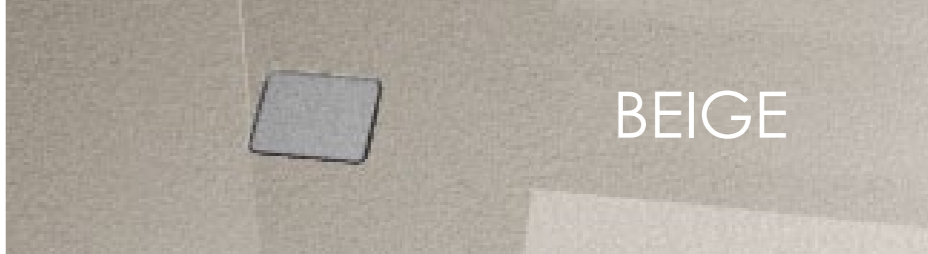

BEIGE

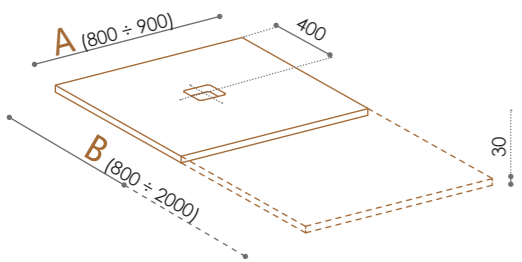

Piatti doccia Shower trays

B	A	A
	800 mm	900 mm
cm	cod.	cod.
80	SHS80X80PO01	
90	SHS80X90PO01	SHS90X90PO01
100	SHS80X100PO01	SHS90X100PO01
110	SHS80X110PO01	SHS90X110PO01
120	SHS80X120PO01	SHS90X120PO01
130	SHS80X130PO01	SHS90X130PO01
140	SHS80X140PO01	SHS90X140PO01
150	SHS80X150PO01	SHS90X150PO01
160	SHS80X160PO01	SHS90X160PO01
170	SHS80X170PO01	SHS90X170PO01
180	SHS80X180PO01	SHS90X180PO01
190	SHS80X190PO01	SHS90X190PO01
200	SHS80X200PO01	SHS90X200PO01

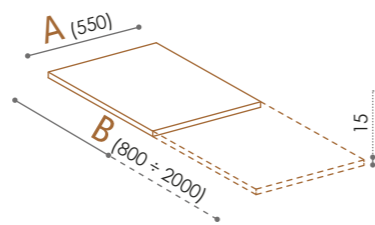

Rivestimenti Wall covering

B	A
	550 mm
cm	cod.
80	TLS55X80PO01
90	TLS55X90PO01
100	TLS55X100PO01
110	TLS55X110PO01
120	TLS55X120PO01
130	TLS55X130PO01
140	TLS55X140PO01
150	TLS55X150PO01
160	TLS55X160PO01
170	TLS55X170PO01
180	TLS55X180PO01
190	TLS55X190PO01
200	TLS55X200PO01

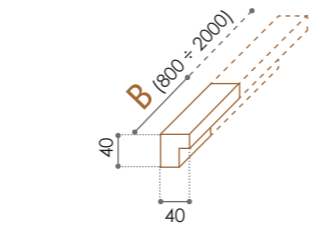

Bordo salva acqua Water save rail

Bordo salva acqua colore bianco fornito su richiesta. Il bordo viene fornito già montato dietro disegno tecnico del cliente.
Water save rail white colour supplied upon request. In this case the rail will be supplied already assembled to the shower tray, behind customer technical drawing.

Sifone per piatti doccia a filo pavimento con foro scarico Ø90 mm.
Drain for shower tray with Ø 90 mm drain hole. Suitable for shower trays flush with the flooring.

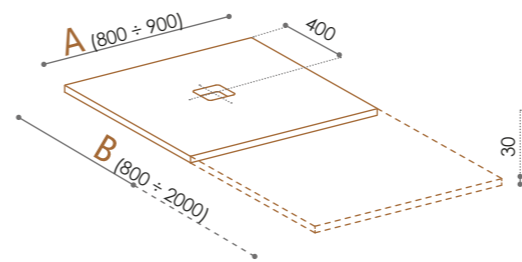
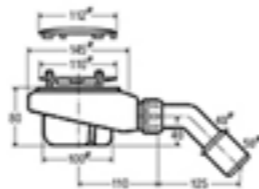

Piatti doccia Shower trays

B	A	A
	800 mm	900 mm
cm	cod.	cod.
80	SHS80X80PO02	
90	SHS80X90PO02	SHS90X90PO02
100	SHS80X100PO02	SHS90X100PO02
110	SHS80X110PO02	SHS90X110PO02
120	SHS80X120PO02	SHS90X120PO02
130	SHS80X130PO02	SHS90X130PO02
140	SHS80X140PO02	SHS90X140PO02
150	SHS80X150PO02	SHS90X150PO02
160	SHS80X160PO02	SHS90X160PO02
170	SHS80X170PO02	SHS90X170PO02
180	SHS80X180PO02	SHS90X180PO02
190	SHS80X190PO02	SHS90X190PO02
200	SHS80X200PO02	SHS90X200PO02

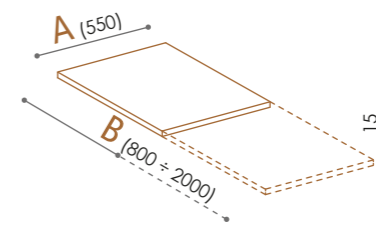

Rivestimenti Wall covering

B	A
	550 mm
cm	cod.
80	TLS55X80PO02
90	TLS55X90PO02
100	TLS55X100PO02
110	TLS55X110PO02
120	TLS55X120PO02
130	TLS55X130PO02
140	TLS55X140PO02
150	TLS55X150PO02
160	TLS55X160PO02
170	TLS55X170PO02
180	TLS55X180PO02
190	TLS55X190PO02
200	TLS55X200PO02

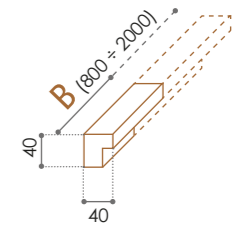

Bordo salva acqua Water save rail

Bordo salva acqua colore beige fornito su richiesta. Il bordo viene fornito già montato dietro disegno tecnico del cliente.
Water save rail beige colour supplied upon request. In this case the rail will be supplied already assembled to the shower tray, behind customer technical drawing.

Sifone per piatti doccia a filo pavimento con foro scarico Ø90 mm.
Drain for shower tray with Ø 90 mm drain hole. Suitable for shower trays flush with the flooring.

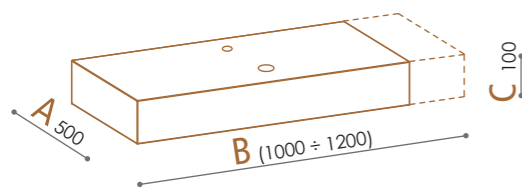
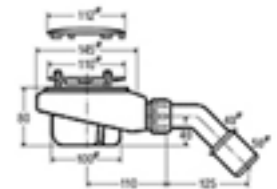

Top

B	B
1000 mm	1200 mm
cod.	cod.
TOPS100X50PO01	TOPS120X50PO01

Il top viene fornito con fori per lavabo e rubinetto come indicato sul disegno. Su richiesta sono realizzabili diametri e disposizioni diversi.

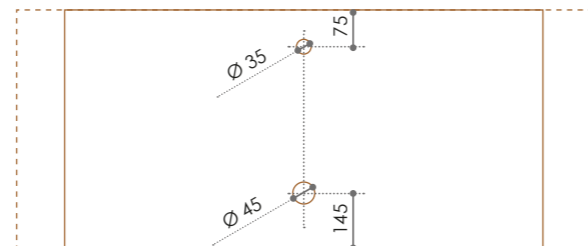

The top is supplied with pre-drilled holes as shown on the drawing. Upon request, holes can be supplied according to customer requirements.

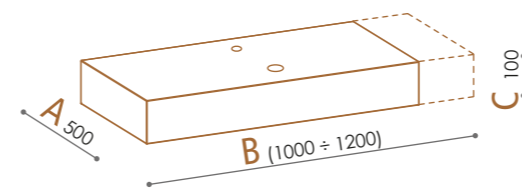

Top

B	B
1000 mm	1200 mm
cod.	cod.
TOPS100X50PO02	TOPS120X50PO02

Il top viene fornito con fori per lavabo e rubinetto come indicato sul disegno. Su richiesta sono realizzabili diametri e disposizioni diversi.

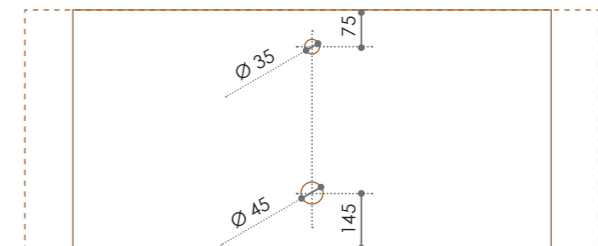

The top is supplied with pre-drilled holes as shown on the drawing. Upon request, holes can be supplied according to customer requirements.



I Top sono compatibili con tutta la gamma di lavabi Glass Design.
The tops are suitable with the full range of Glass Design washbasins.

Laguna



Ø foro / hole = 45 mm
peso / weight = 4,70 kg
Base anello cromata e piletta inclusi
Chrome plug and chrome ring basement included

code:



night
LAGUNAT33



smoke
LAGUNAT43



red
LAGUNAT16



blue
LAGUNAT42

TERRA

TORTORA

GRIGIO

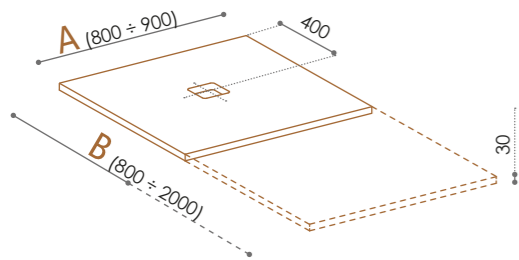

Piatti doccia
Shower trays

B	A	A
	800 mm	900 mm
cm	cod.	cod.
80	SHS80X80PO09	
90	SHS80X90PO09	SHS90X90PO09
100	SHS80X100PO09	SHS90X100PO09
110	SHS80X110PO09	SHS90X110PO09
120	SHS80X120PO09	SHS90X120PO09
130	SHS80X130PO09	SHS90X130PO09
140	SHS80X140PO09	SHS90X140PO09
150	SHS80X150PO09	SHS90X150PO09
160	SHS80X160PO09	SHS90X160PO09
170	SHS80X170PO09	SHS90X170PO09
180	SHS80X180PO09	SHS90X180PO09
190	SHS80X190PO09	SHS90X190PO09
200	SHS80X200PO09	SHS90X200PO09

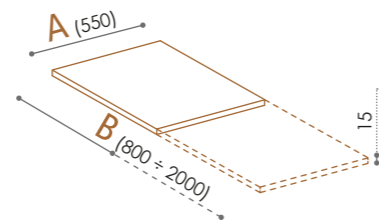

Rivestimenti
Wall covering

B	A
	550 mm
cm	cod.
80	TLS55X80PO09
90	TLS55X90PO09
100	TLS55X100PO09
110	TLS55X110PO09
120	TLS55X120PO09
130	TLS55X130PO09
140	TLS55X140PO09
150	TLS55X150PO09
160	TLS55X160PO09
170	TLS55X170PO09
180	TLS55X180PO09
190	TLS55X190PO09
200	TLS55X200PO09

Bordo salva acqua
Water save rail

Bordo salva acqua colore tortora fornito su richiesta. Il bordo viene fornito già montato dietro disegno tecnico del cliente.
Water save rail in tortora colour supplied upon request. In this case the rail will be supplied already assembled to the shower tray, behind customer technical drawing.

Sifone per piatti doccia a filo pavimento con foro scarico Ø90 mm.
Drain for shower tray with Ø 90 mm drain hole. Suitable for shower trays flush with the flooring.

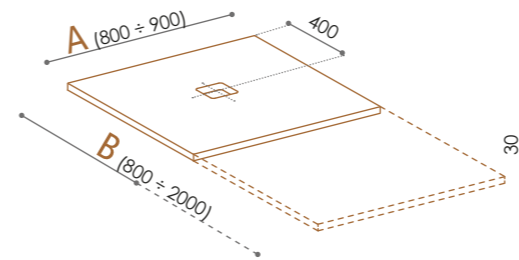
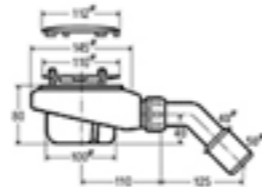

Piatti doccia
Shower trays

B	A	A
	800 mm	900 mm
cm	cod.	cod.
80	SHS80X80PO43	
90	SHS80X90PO43	SHS90X90PO43
100	SHS80X100PO43	SHS90X100PO43
110	SHS80X110PO43	SHS90X110PO43
120	SHS80X120PO43	SHS90X120PO43
130	SHS80X130PO43	SHS90X130PO43
140	SHS80X140PO43	SHS90X140PO43
150	SHS80X150PO43	SHS90X150PO43
160	SHS80X160PO43	SHS90X160PO43
170	SHS80X170PO43	SHS90X170PO43
180	SHS80X180PO43	SHS90X180PO43
190	SHS80X190PO43	SHS90X190PO43
200	SHS80X200PO43	SHS90X200PO43

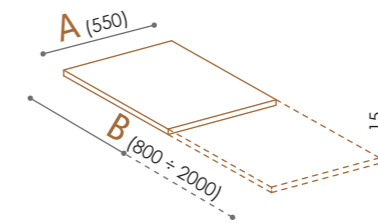

Rivestimenti
Wall covering

B	A
	550 mm
cm	cod.
80	TLS55X80PO43
90	TLS55X90PO43
100	TLS55X100PO43
110	TLS55X110PO43
120	TLS55X120PO43
130	TLS55X130PO43
140	TLS55X140PO43
150	TLS55X150PO43
160	TLS55X160PO43
170	TLS55X170PO43
180	TLS55X180PO43
190	TLS55X190PO43
200	TLS55X200PO43

Bordo salva acqua
Water save rail

Bordo salva acqua colore grigio fornito su richiesta. Il bordo viene fornito già montato dietro disegno tecnico del cliente.
Water save rail in grey colour supplied upon request. In this case the rail will be supplied already assembled to the shower tray, behind customer technical drawing.

Sifone per piatti doccia a filo pavimento con foro scarico Ø90 mm.
Drain for shower tray with Ø 90 mm drain hole. Suitable for shower trays flush with the flooring.

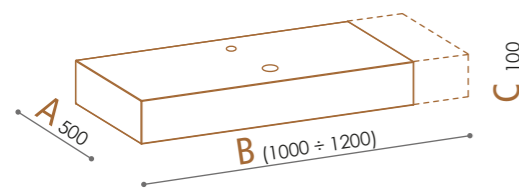
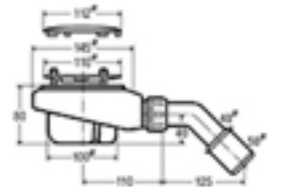

Top

B	B
1000 mm	1200 mm
cod.	cod.
TOPS100X50PO09	TOPS120X50PO09

Il top viene fornito con fori per lavabo e rubinetto come indicato sul disegno. Su richiesta sono realizzabili diametri e disposizioni diversi.

The top is supplied with pre-drilled holes as shown on the drawing. Upon request, holes can be supplied according to customer requirements.

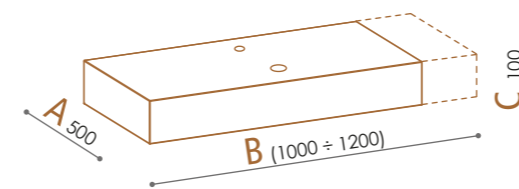
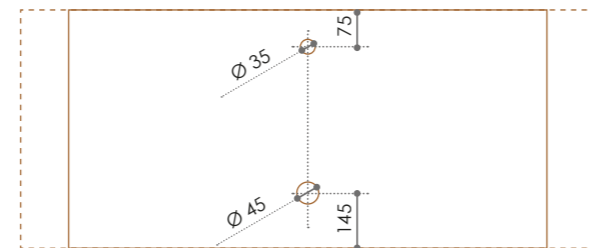

Top

B	B
1000 mm	1200 mm
cod.	cod.
TOPS100X50PO43	TOPS120X50PO43

Il top viene fornito con fori per lavabo e rubinetto come indicato sul disegno. Su richiesta sono realizzabili diametri e disposizioni diversi.

The top is supplied with pre-drilled holes as shown on the drawing. Upon request, holes can be supplied according to customer requirements.

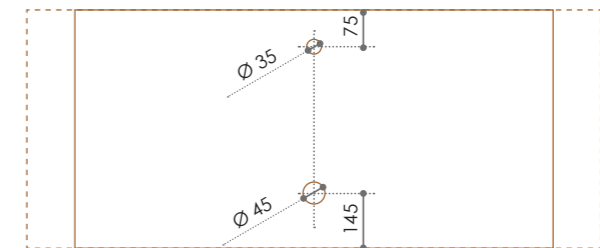

I Top sono compatibili con tutta la gamma di lavabi Glass Design.
The tops are suitable with the full range of Glass Design washbasins.

Laguna



Ø foro / hole = 45 mm
peso / weight = 4,70 kg

Base anello cromata e piletta inclusi
Chrome plug and chrome ring basement included

code:



night
LAGUNAT33



smoke
LAGUNAT43



red
LAGUNAT16



blue
LAGUNAT42

Note Tecniche

Tutti i prodotti delle serie NATURA Lux, NATURA, TERRA Lux e TERRA sono realizzati in TeknoForm®, una resina termoindurente e cariche di minerali naturali, con esclusiva texture in legno e pietra.

Tutti gli elementi sono prodotti con pigmenti colorati, integrati nel materiale e rivestiti da un film protettivo ad elevata durezza. Il film esterno garantisce, inoltre, un'alta resistenza alle macchie e agli acidi, agevolandone la pulizia.

Entrambe le texture hanno un effetto a rilievo che rende i piatti doccia antiscivolo.

Per la pulizia quotidiana è sufficiente usare una spugna non abrasiva, acqua ed un detergente neutro (per essere sicuri che il detergente sia veramente neutro deve essere specificato sul flacone).

Non usare detergenti acidi, basi forti e solventi.

SOLO PER SERIE TERRA: nel caso in cui le superfici siano state danneggiate o graffiate, si può ripristinare mediante l'apposito kit ritocco ordinabile a catalogo.

Il kit comprende: una carta abrasiva per stondare eventuali parti taglienti dovute al danneggiamento, una resina bicomponente liquida colorata, da usare successivamente per ripristinare il film protettivo.

I piatti doccia si posano su massetto rasato impermeabilizzato, utilizzando collanti specifici quali MAPEI GRANIRAPID, KERAKOOL H40 o simili. Il collante deve essere di colore bianco.

Prima della posa, verificare che il piatto doccia sia perfettamente planare. Nel caso presenti incurvamenti dovuti all'elasticità del materiale, disporre il piatto su un piano e mantenerlo in questa posizione per circa 4 ore. Dopodiché, assicurarsi che sia tornato planare e procedere alla posa, facendo attenzione a posizionarlo in bolla, verificandolo con la livella sui 4 lati.

I piatti doccia rispettano la normativa CSA B45.5-11/IAPMO Z124 2011 riguardante la pendenza minima dell'1% che garantisce un corretto deflusso dell'acqua. A causa del fenomeno fisico denominato "tensione superficiale", correlato alla rugosità del materiale, è possibile che sulla superficie restino alcune gocce d'acqua. Questo fenomeno è accentuato nei casi in cui la durezza dell'acqua risulti essere maggiore.

Technical Remarks

All products of NATURA Lux, NATURA, TERRA Lux and TERRA are realised in TeknoForm®, a thermosetting resin with natural mineral charges, with exclusive wood and stone texture.

All the products are produced with coloured pigments, contained in the material, and covered by a protective film, with high hardness. The external film guarantees high spots and acids resistance.

Both the textures have relief effect that makes the shower tray extremely anti-slip.

For ordinary cleaning it is enough to use a non-abrasive sponge and neutral detergent (as identified on the bottle).

Do not use acid detergents, strong bases or solvents and do not use an abrasive sponge for the cleaning of the surface.

ONLY FOR TERRA SERIE: in case the surfaces are damaged or scratched, it is possible to restore it with the proper maintenance kit that can be ordered from the catalogue.

The kit includes abrasive paper, which is used to round possible sharp parts caused by the damage. The bi-component liquid and coloured resin is used to restore the protective film.

The shower bases are laid on smooth and waterproofed subfloor, using specific adhesives such MAPEI GRANIRAPID, KERAKOLL H40 or similar. The glue should be white in colour.

Before laying, verify that the shower base is perfectly plane. In case of slight warpage, caused by the elasticity of the material, lay the shower base on a flat surface and keep it on this position for about 4 hours.

After that verify its planarity and proceed with the installation by laying the tray flat, paying attention to fit-it level and verifying it on all 4 sides

The shower bases are in compliance with CSA B45.5-11/IAPMO Z124 2011, regarding the minimum slope of 1% that grants a correct flow of water.

Because of the physical phenomenon called "superficial tension", in connection with the roughness of the material, it is possible that there can be some water drops on the surface.

This phenomenon can become more marked in hard water areas.

Caratteristiche fisiche

	NORMA RIFERIMENTO	RISULTATO TEST
Durezza superficie	SCALA MOHS	3.0
Dilatazione termica lineare	UNI EN 103	27.0
Scivolosità	DIN 51097	18.4° - A + B
Resistenza a flessione	ASTM C99	N/mm ² 13.3
Resistenza a compressione	ASTM C170	369 da N/cm ²
Resistenza colori alla luce	DIN 51094	colori inalterati
Resistenza al fuoco		CL A1 - autoestinguento

Resistenze chimiche secondo UNI 10944

LIQUIDO	TEMPO	VALUTAZIONE
Alcool 95°	8 ore	5
Acetone	60''	5
Caffè	8 ore	5
Olio di oliva	8 ore	5
Mercurio cromo	60''	4
Detergente < 5%	8 ore	5
Vino rosso	8 ore	5
Coca cola	8 ore	4
Rossetto	8 ore	5
Inchiostro	8 ore	5
Detergente concentrato	8 ore	5
Alcool 95%	8 ore	5
Tintura per capelli	60''	3
Anticalcare	8 ore	5
Candeggina	1 ora	5

5. nessuna variazione
 4. variazione visibile parzialmente e solo orientando opportunamente il provino
 3. variazione parziale visibile indipendentemente dall'orientamento del provino
 2. evidente variazione del provino
 1. grave danneggiamento della superficie con rottura/screpolatura del film di vernice

Physical Characteristics

	REF. LAW TEST RESULT	TEST RESULT
Surface Hardness	SCALA MOHS	3.0
Linear thermal dilatation	UNI EN 103	27.0
Slipperiness	DIN 51097	18.4° - A + B
Bending strength	ASTM C99	N/mm ² 13.3
Resistance to compression	ASTM C170	369 da N/cm ²
Colours's resistance to light	DIN 51094	unchanged colors
Fire resistance		CL A1 - self-extinguishing

Chemical Resistances according to UNI 10944

LIQUID	TIME	VALUTATION
Alcool 95°	8 H	5
Acetone	60''	5
Coffee	8 H	5
Olive Oil	8 H	5
Mercurio chromium	60''	4
Detergent	8 H	5
Red wine	8 H	5
Coke	8 H	4
Lipstick	8 H	5
Ink.	8 H	5
Conc. Detergent	8 H	5
Alcool 95%	8 H	5
Hair Dye	60''	3
Anti-limescale	8 H	5
Bleach	1 H	5

- 5- no variation
 4- variation partially visible from certain angles to the test material
 3- variation partially visible apart from any angle to the test material
 2- noticeable variation in the test material
 1- Serious damage of the surface with breaking and/or scratching of the paint film



“Accessori & Complementi”

Accessories & Complements

Dettagli di “valore”



Specchio Tondo
round mirror

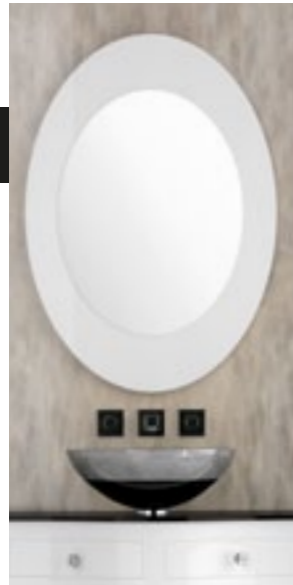
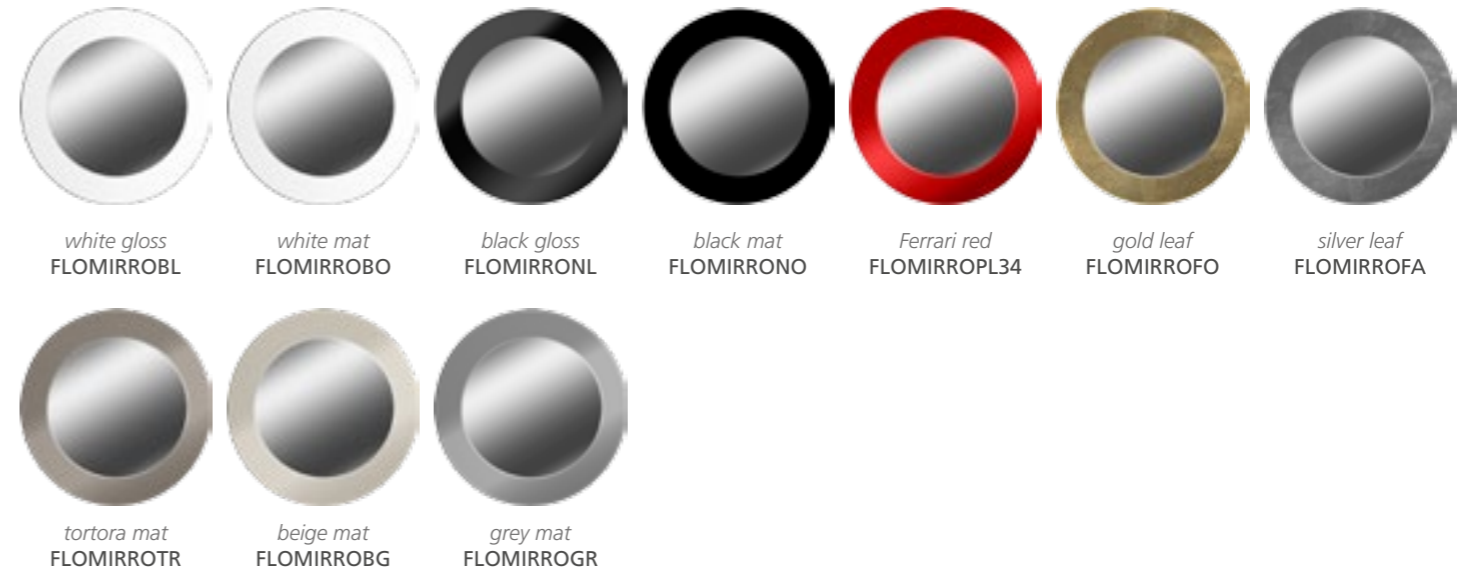
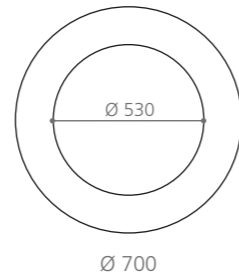

Specchio Ovale
oval mirror

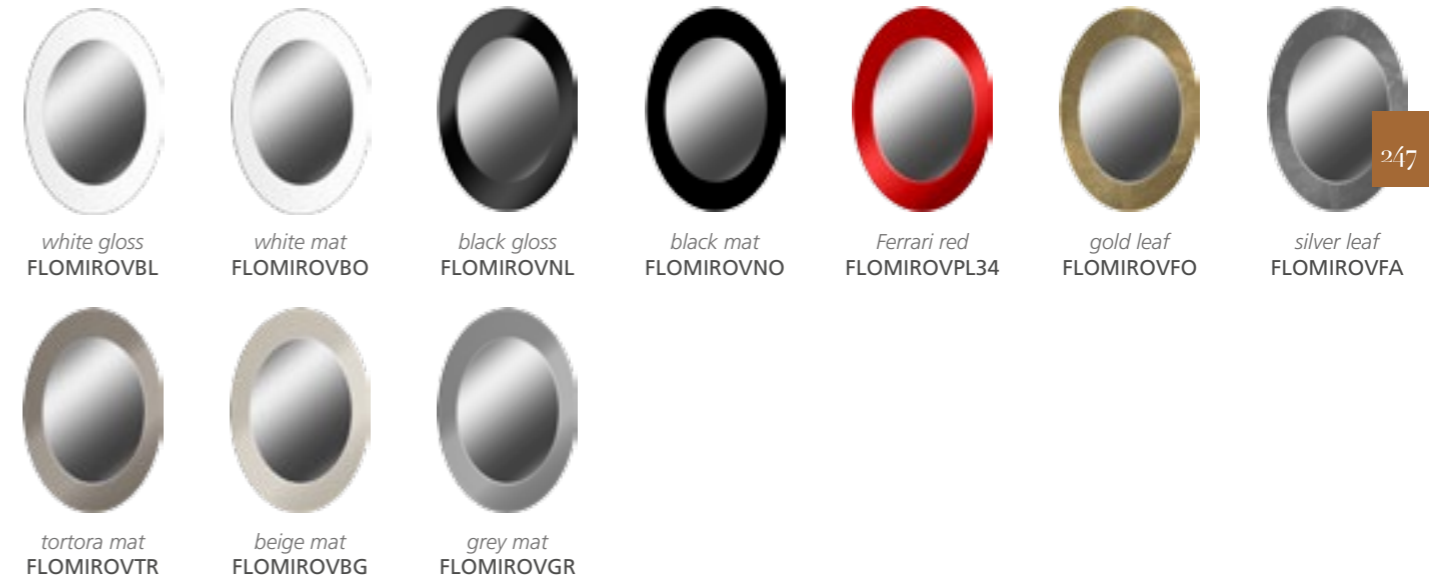
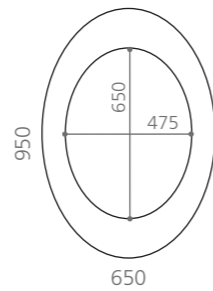

Specchio Rettangolare
rectangular mirror

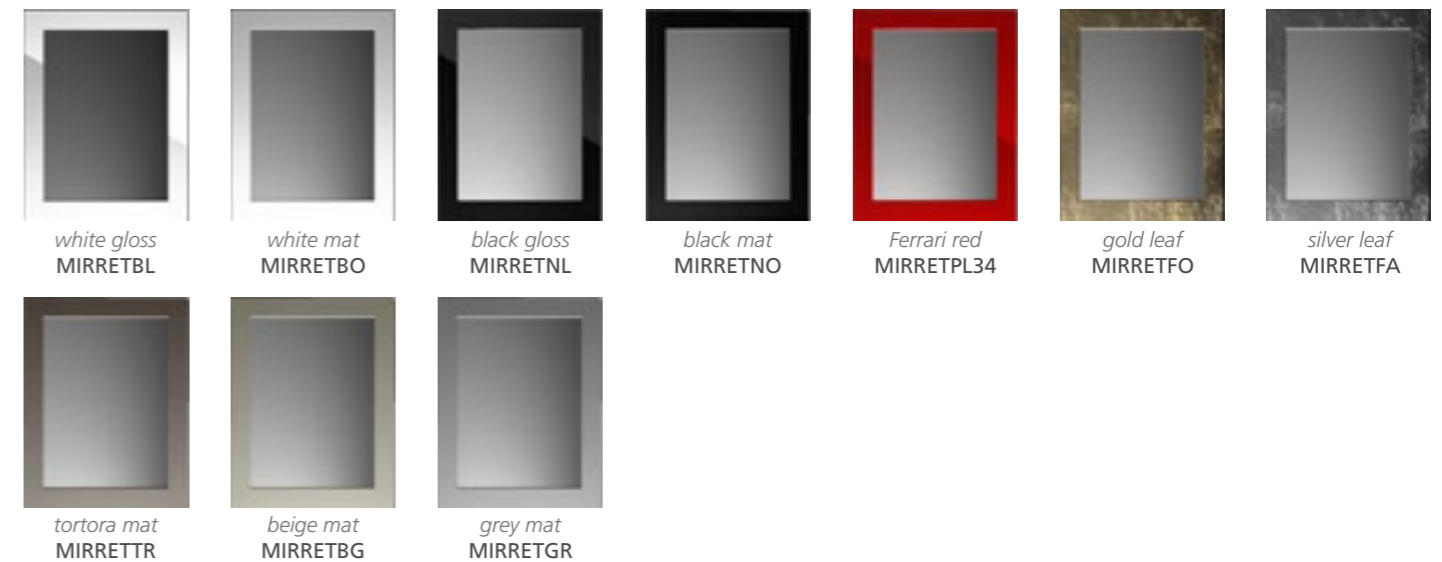
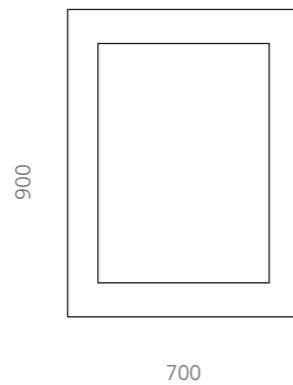



Specchio bj

bj mirror

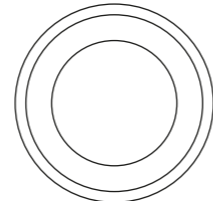

Ø 660



white / silver
ALUBJMIRA05



black / silver
ALUBJMIRA02



gold leaf 3d
ALUBJMIRFO



silver leaf 3d
ALUBJMIRFA



copper leaf 3d
ALUBJMIRFR

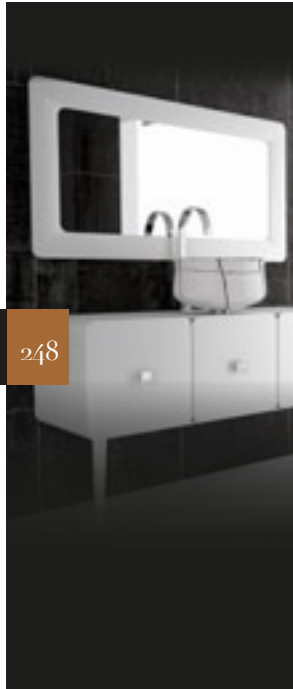

Specchio Misura

misura mirror

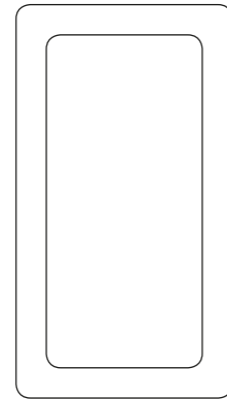

1200

600



white mat
MSMIR120X60B



black mat
MSMIR120X60N



platinum mat
MSMIR120X60PL

Piletta scarico libero

Piletta a scarico libero con logo GD
Waste with free flow plug with GD logo
(Ø 70 - H 90 mm)

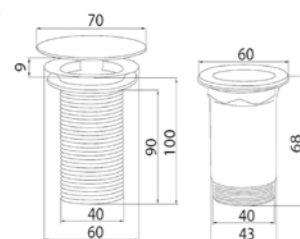

cromo
chrome
SCCR



ottone nero opaco
brass black mat finish
SCBL



ottone oro
brass gold finish
SCGD

Piletta ABS scarico libero

Piletta ABS a scarico libero con logo GD
ABS waste with free flow plug with GD logo
(Ø 72 - H 90 mm)

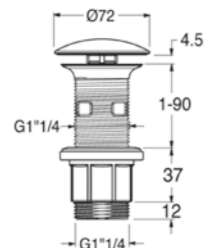

ABS cromo
ABS chrome
SCCR 100

Piletta klik-clak

Piletta klik clak con logo GD (senza troppo pieno)
Up & Down waste with GD logo (without overflow)
(Ø 63,5 - H 100 mm)

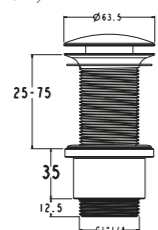

cromo
chrome
SCCRP



ottone nero opaco
brass black mat finish
SCBLP



ottone oro
brass gold finish
SCGDP

Piletta ABS klik-clak

Piletta ABS klik clak con logo GD utilizzabile per lavabi senza e con troppo pieno
Up & Down ABS waste with GD logo suitable for washbasins with and without overflow
(Ø 72 - H 90 mm)



ABS cromo
ABS chrome
SCCRP 100

Piletta klik-clak

Piletta klik clak con logo GD (con troppo pieno)
Up & Down waste with GD logo (with overflow)
(Ø 63,5 - H 100 mm)

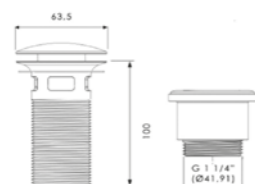

cromo
chrome
SCCRTP



ottone nero opaco
brass black mat finish
SCBLTP



ottone oro
brass gold finish
SCGDTP

Piletta scarico libero tappo XL

Piletta a scarico libero con logo GD
Waste with free flow plug with GD logo
(Ø 105 - H 100 mm)

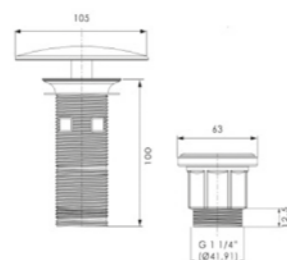

ABS cromo
ABS chrome
SCCR XL

Base anello

Base ring

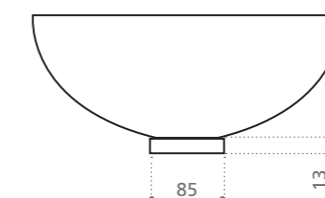

oro / gold
ANF3



cromo / chrome
ANF4

Troppo pieno

Troppo pieno completo per scarico lavabo 1" 1/4
Overflow joint for basin waste 1" 1/4

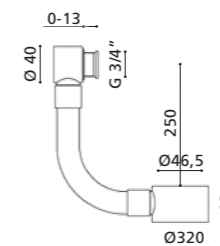

cromo / chrome
TP



oro / gold
TPG

Troppo pieno ABS

Troppo pieno per lavabi sottopiano ABS bianco (con anello cromato)
White ABS basin overflow (with chromed ring) for under mounted wash basins

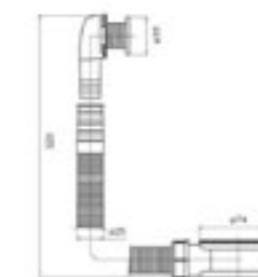

cromo / chrome
TPA

Tondo

Sifone tondo
Round siphon

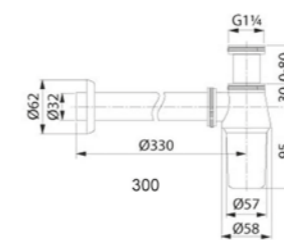

cromo / chrome
SIFHF4



oro / gold
SIFHF3

Quadro

Sifone quadrato
Square siphon

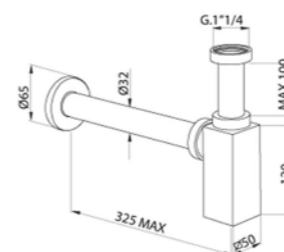

cromo / chrome
SIFQF4



oro / gold
SIFQF3

Design senza confini Design without borders

Vetro Freddo®

Il Vetro Freddo® è un materiale innovativo, composto da pigmenti vetrosi e resine. La sua caratteristica principale è la sua versatilità nell'adattarsi a qualsiasi tipo di forma. E' l'esaltazione della materia che si esprime attraverso l'anima del suo colore. La natura della sua materia, composta da pigmenti vetrosi e pertanto trasparenti, permette al Vetro Freddo® di avere uno dei suoi principali punti di forza, e cioè la possibilità di esprimersi in colori trasparenti, traslucidi od opachi. Nessun limite quindi a livello cromatico e, oltre alla gamma di colori già esistente, è possibile scegliere in base alle proprie esigenze, uno dei numerosi colori presenti nella mazzetta "RAL". Il Vetro Freddo® ha una resistenza termica di circa 100°C e può essere lavorato con gli stessi utensili del marmo o del vetro. Tutti gli oggetti in Vetro Freddo® si possono lavare con qualsiasi tipo di sapone o detergente neutro non granulare, usando panni o spugne non abrasive. In caso di graffi superficiali, si può ripristinare l'oggetto intervenendo con un panno imbevuto di olio d'oliva o una semplice crema per le mani. In caso di graffi più profondi, è possibile ripristinare con una speciale carta vetro suggerita dal produttore in base al colore o al tipo di oggetto.

Vetro Freddo® is an innovative material composed of glass pigments and resin. Highly versatile, its aesthetic characteristics are unique in that it can present as transparent, semi-transparent or opaque due to the composition of glass pigments. Vetro Freddo is likewise heat resistant up to temperatures of 100c, and can be crafted in a fashion similar to marble or glass. With regards to colour, the possibilities are endless. Any colour from the "RAL" colour scheme can be chosen and easily adapted. Vetro Freddo can be cleaned with any type of non-granular soap, using soft sponges or tissues.

In the event of superficial damage (scratches), the damaged area should be gently rubbed with a sheet soaked in olive oil.

In the case of deeper scratches or damage, a special replacement glass paper is available from the manufacturer for the white colour.



Pert® polimero tecnologico

Il Pert® è un polimero tecnologico dalle qualità eccezionali, che unisce un basso peso specifico ad un'elevata resistenza meccanica. Particolarmente adatto in quei settori dove l'esigenza della leggerezza del peso è fondamentale (nautico, aereo, camper...). E' un materiale che permette la realizzazione di prodotti di elevato design, eseguiti a regola d'arte, rispettando angoli, raggi, bassorilievi e planarità con la possibilità di scelta tra una vasta gamma di colori, personalizzabili a richiesta.

Pert® is a technological polymer of extraordinary quality, combining a low density with high mechanical resistance. It is particularly suited to fields where low density materials are essential (e.g. in nautical, aeronautical, camping, ...). This material likewise enables the creation of perfectly crafted angles and smooth surfaces. Products made from Pert are also available in a wide selection of colours.

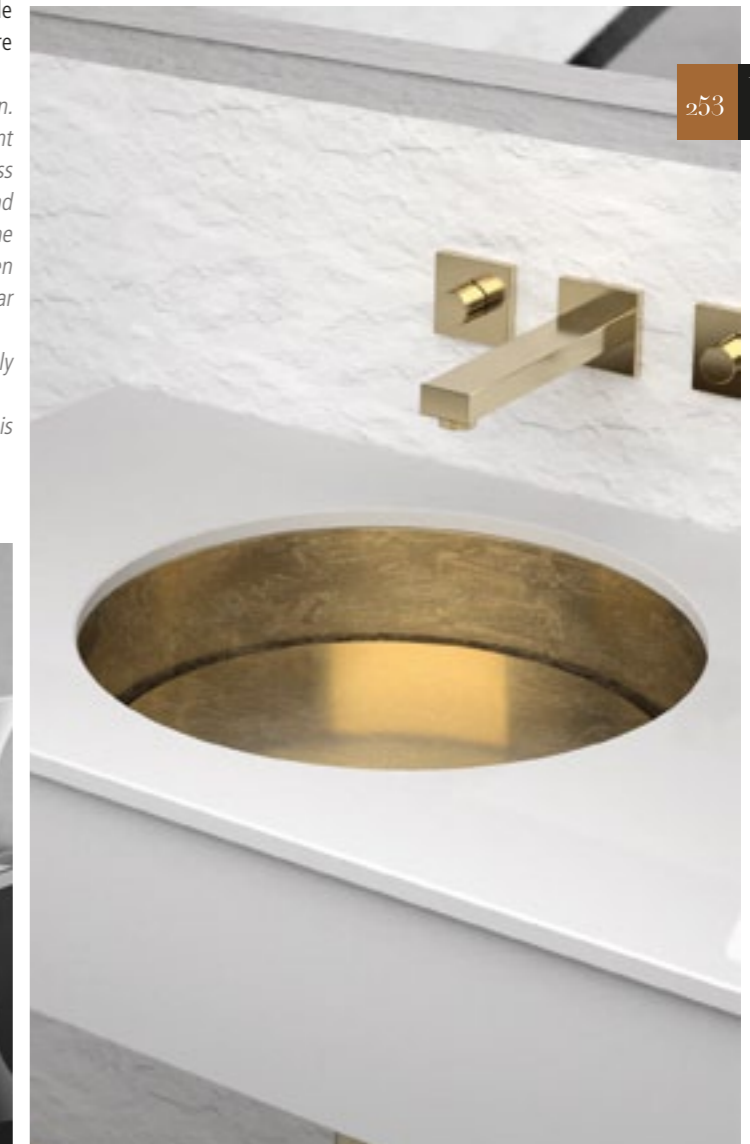

“Materiali & Certificazioni”

Materials & Certifications

Il vetro di Murano è da sempre sinonimo di raffinatezza, leggerezza ed eleganza.

I maestri vetrai hanno saputo sviluppare tecniche di lavorazioni privilegiate, nel rispetto della millenaria tradizione che rende il vetro di Murano un prodotto unico, prestigioso e inimitabile.

Murano glass is a synonym for elegance and timelessness.

By combining innovative techniques with traditional artisan workmanship, unique, prestigious and inimitable objects are created.

TeknoForm[®] è il materiale delle "texture", costituito da polimeri di varia natura, si esprime dando vita a prodotti monoscocca, esaltando le sue superfici. Dai mosaici alle pietre, dai marmi ai legni, tante soluzioni che danno vita a prodotti unici.

TeknoForm[®] is a polymer-based material, capable of mimicking a variety of textures from mosaics to stone, marble to wood, from which an incredible variety of options can be realised through the use of this material.

Prodotto hi-tech, elegante e contemporaneo che nasce da una fusione di lega di alluminio. La decorazione è realizzata a pennello, con la tecnica del graffiato, per ottenere un effetto bicromatico. Il bordo è spazzolato e lucidato a mano, per valorizzare l'anima ed il colore tipico di questo materiale.

A high-tech product, both elegant and contemporary, born from a merger of aluminum alloys. The decorations are brush-painted, employing a special brush technique in order to obtain a bi-chromatic effect. The board is brushed and polished by hand to enhance the soul and color, which are typical for this material.

Il Bi-Mat nasce dalla fusione di fibra di vetro (80%) con VetroFreddo Light, integrati tra loro per produrre un materiale innovativo, ultraleggero e resistente. La sua particolare composizione rende il prodotto estremamente versatile, conferendo leggerezza ad oggetti di grossi volumi, come nel caso delle vasche, facilitandone l'utilizzo e la collocazione. La superficie esterna si presenta bianca semilucida frutto della spazzolatura a mano ed è particolarmente idonea ad essere trattata nelle svariate tonalità cromatiche, permettendo di creare prodotti unici.

Bi-Mat is born in the merger of fiberglass (80%) and Cool Glass Light, creating an innovative material that is both lightweight and durable. Its particular composition makes the product extreme versatile, allowing objects of large volume, for example a bathtub, to be lightweight for easy use and placement. The outer surface is white gloss and brushed by hand and particularly suitable for processing in a variety of colours and allowing the creation of unique products.

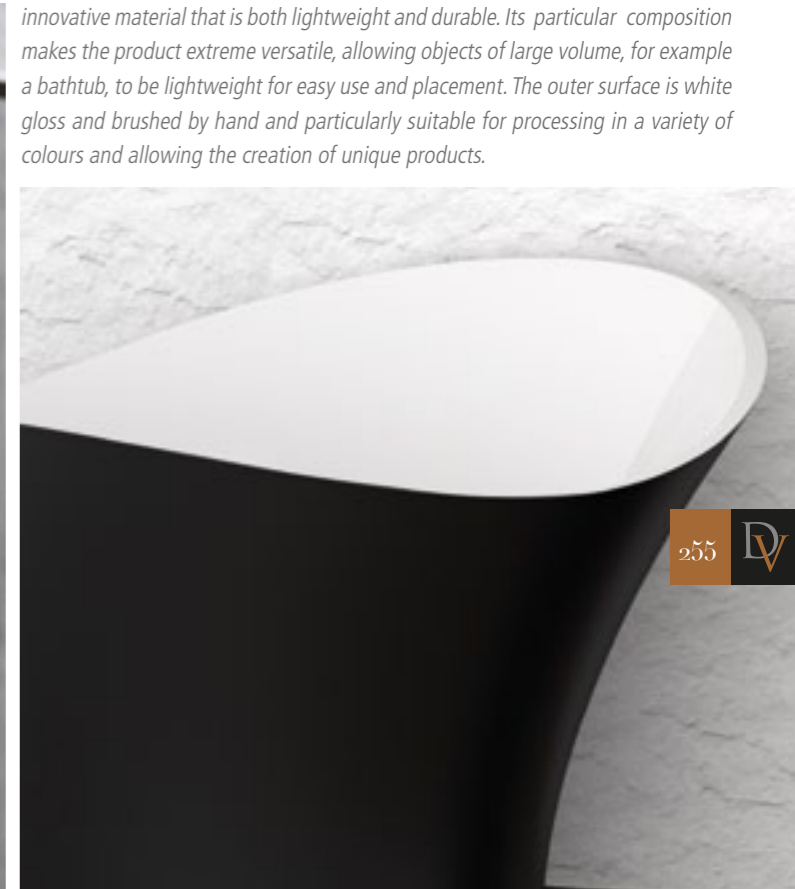

DV 254

DV 255

Nuova tecnologia applicata per dar vita ad un prodotto inox (18/8) tridimensionale.

Peso specifico ridottissimo nonostante i volumi.

Varie sono le espressioni cromatiche dal colore tipico dell'inox lucido, spazzolato fino all'ultima generazione di colori high-tech.

The products of the INOX ZERO Collection are made out of stainless steel (18/8), utilising advanced production processes enabling the combination of expressive design with of low weight. A wide range of colours can be achieved, from timeless metallic shades to prestigious brushed and avant-garde colours.

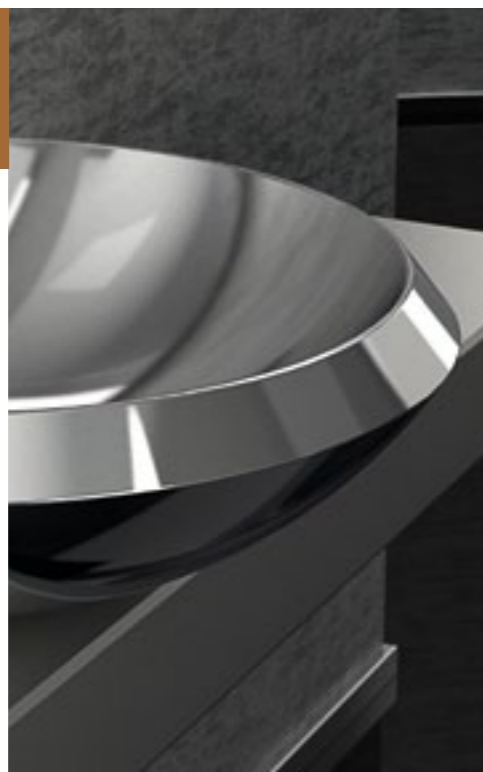

Collezioni esclusive, realizzate in cristallo purissimo al 24% pb.

Si tratta di prodotti raffinatissimi, soffiati a bocca e molati a pietra con abilità, dai nostri maestri secondo le più antiche e nobili arti vetrarie. Nessuna macchina, nessuna tecnologia, ma solo prodotti d'arte, classici, contemporanei ... futuristici.

Exclusive collections created from pure crystal with 24% lead content.

These utmost refined products are mouth-blown and bevelled in stone by our master artists according to the most ancient and noble glass arts. Neither machines nor technology are employed in the process, resulting in classical, contemporary or futuristic art products.



Il progetto Atelier nasce dalla ricerca stilistica che una nostra equipe interna realizza rivolgendo lo sguardo al mondo della moda. I colori e le texture che vengono rappresentati nel programma sono la sintesi delle nuove tendenze.

The "Florence Glass Atelier" project aims to incorporate fashion philosophy into product research through enhancing crystal material with colours and textures of fashion trends.



Riflessi perfetti e inalterabili.

Una nuova materia dalle caratteristiche uniche.

Ottenuto attraverso un procedimento di scioglimento e cristallizzazione di ceramiche e particelle di silicio, un processo molto simile alle condizioni naturali di formazione del granito. Il suo aspetto esteriore invece è molto simile al marmo, ma con caratteristiche di durezza, lucentezza, inassorbienza e resistenza nettamente superiori. Assolutamente omogeneo, inattaccabile da qualsiasi tipo di sostanza acida o alcalina.

La tecnologia e la duttilità di questo materiale consentono di progettare l'ambiente bagno realizzando qualsiasi tipo di misura per assecondare e soddisfare le richieste più esigenti.

1 Materiale ecologico per eccellenza, ricavato da elementi naturali, non presenta né resine né solventi.

2 Riciclabile al 100%.

3 Inattaccabile dal calcare.

4 Colore inalterabile, resistente anche ad esposizioni prolungate ai raggi UV.

5 Resistente a qualsiasi prodotto usato per la pulizia del bagno.

6 Facile da pulire.

Perfect and unalterable reflections.

A new material with unique features.

It is obtained through a process of dissolution and crystallization of ceramics and silicon parts. The process is very similar to the natural characteristics of granite formation.

Its feature is very similar to marble, but with advantages in terms of hardness, brightness and resistance.

It is homogeneous, durable, acid and alkaline proof.

The technology and ductility of this material allow to design your bathroom in any customised dimensions in order to meet individual requirements.

1 *Environmentally friendly; obtained from natural elements, free from resins and solvents.*

2 *100% recyclable.*

3 *Unaffected by limestone.*

4 *Excellent colour durability; resistant to prolonged UV rays exposure.*

5 *Resistant to all bathroom cleaning products.*

6 *Easy to clean.*

Certificazioni Full Colour Glass / Full Colour Glass certifications

RISULTATI DEI TEST CONDOTTI IN LABORATORIO UNI EN 15388:2008 / LABORATORY TESTS PERFORMANCES UNI EN 15388:2008

UNI EN 13501-1	Reazione al fuoco <i>Fire resistance</i>	Classe A1
UNI EN 13755 UNI EN 1936	Densità apparente e assorbimento acqua <i>Apparent density and water absorption</i>	wa=0.0% - mv=2430 kg/m³
UNI EN 14617-6	Resistenza agli shock termici <i>Thermo shock resistance</i>	Nessuna variazione <i>No alterations</i>
UNI EN 14617-9	Resistenza all'urto <i>Shock resistance</i>	30 mm=4J - 18 mm=1J - 12 mm=1J
UNI EN 14617-10	Resistenza chimica <i>Chemical resistance</i>	Nessuna macchia/corrosione <i>No stain or corrosion</i>
UNI EN 12372	Resistenza a flessione <i>Flexion resistance</i>	Rtf=37.5 MPa
UNI EN 14617-11	Coefficiente di espansione termica lineare <i>Linear factor of thermo expansion</i>	Massima idoneità <i>maximum fitness</i>
UNI EN 14617-13	Resistenza elettrica <i>Electric resistance</i>	Massima idoneità <i>maximum fitness</i>

Certificazioni lavabi / washbasins certifications:

RISULTATI DEI TEST CONDOTTI IN LABORATORIO UNI EN 14688:2007 / LABORATORY TESTS PERFORMANCES UNI EN 14688:2007

UNI EN 14688-par 4.2	Svuotamento dell'acqua <i>Water emptying</i>	il campione è conforme <i>The product is in conformity with the par.4.2. / UNI EN 14688:2007</i>
UNI EN 14688-par 4.4	Resistenza alle sostanze chimiche e agli agenti macchianti. <i>Resistance to chemical substances and soiling agents</i>	Non si verificano segni di deterioramento superficiali permanenti. <i>There are no signs of permanent surface deterioration.</i>
UNI EN 14688-par 4.6	Pulibilità <i>Cleanness</i>	I lavabi risultano avere superfici funzionali e conformi <i>The basins result to have surfaces which are functional and in conformity.</i>

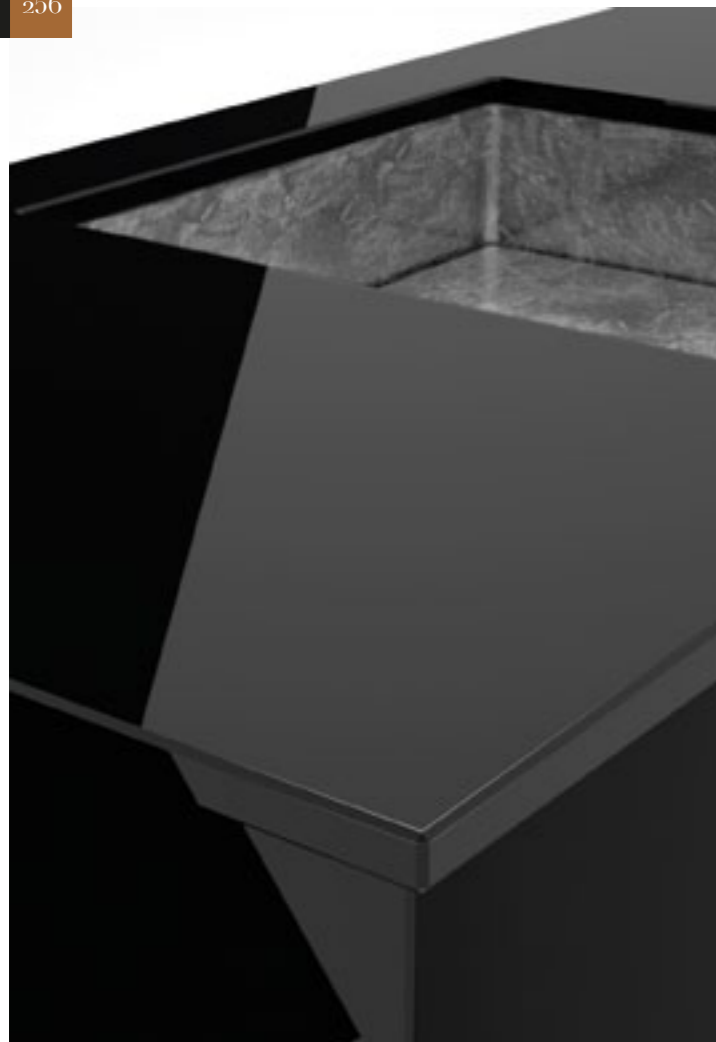



CERTIFICAZIONI
CERTIFICATIONS



Made in Italy



è un marchio registrato da is a trademark registered by



GLASS DESIGN S.R.L.
Via Limitese, 122/124 - 50053 Vinci (Firenze) ITALY
Tel. +39 0571 902311 / +39 0571 902501
Fax +39 0571 902312
glassdesign@glassdesign.it | www.glassdesign.it

Graphic and visual design:
info@giacomomasoni.com

Copyright © Glass Design srl. Tutti i diritti riservati - All rights reserved.

stampato su carta certificata FSC®



Il marchio FSC identifica i prodotti derivanti dal legno, provenienti da foreste gestite in maniera responsabile secondo rigorosi standard ambientali, sociali ed economici.



DA VINCI TUSCANY

DA VINCI TUSCANY

DA VINCI TUSCANY

DA VINCI TUSCANY

DA VINCI TUSCANY

DA VINCI TUSCANY

DA VINCI TUSCANY

DA VINCI TUSCANY

DA VINCI TUSCANY

DA VINCI TUSCANY

DA VINCI TUSCANY

DA VINCI TUSCANY

DA VINCI TUSCANY



DA VINCI TUSCANY

www.glassdesign.it