

MESTRE[®]

Auxiliares series

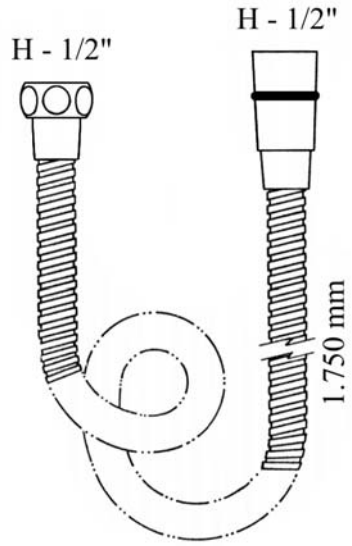



— 015055.0AR.00
 .30
 .50
 .62
 .71

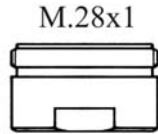

— 014718.0AR.00
 .30
 .50
 .62
 .71
 .73

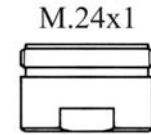

— 013250.0AR.00
 .30
 .50
 .62
 .71
 .73

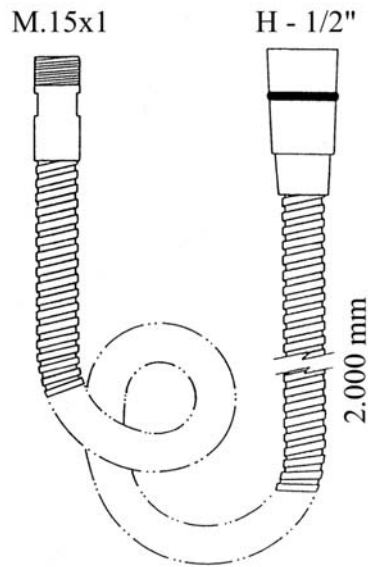

— 015053.0AR.00
 .50
 .62
 .71
 .73



— 015847.0AR.00
 .50
 .71

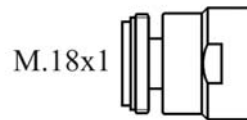

— 015848.0AR.00
 .50
 .71

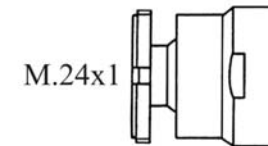

— 014260.0AR.00
 .30
 .50
 .62
 .71
 .73

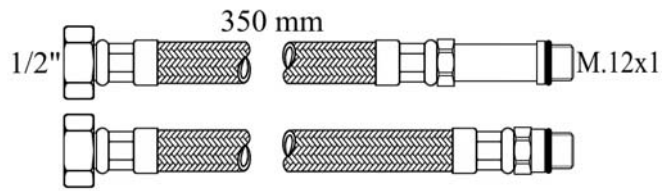

015508.OAR.99 —

Para juego de bañera de 2 agujeros
For 2 hole bath set

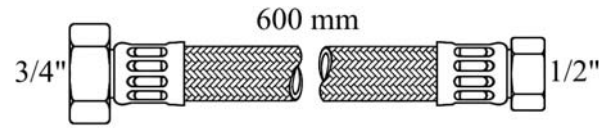

015943.OAR.99 —

Para juego de bañera de 4 y 5 agujeros
For 4 and 5 hole bath sets

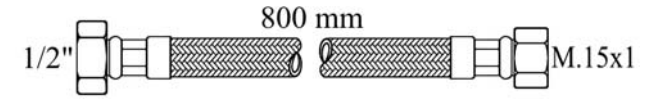

015940.OAR.99 —

Para juego de bañera de 4 agujeros
For 4 hole bath sets

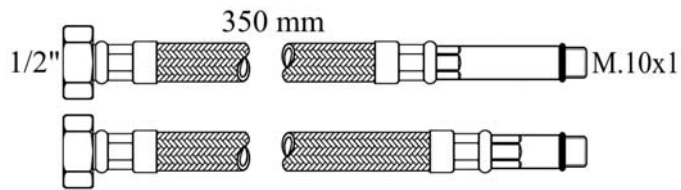

015308.OAR.99 —

Para juegos de lavabo de 3 agujeros,
monoblocs lavabo, bidé, cocina y
monomandos lavabo y bidé.
For 3 hole basin set, single hole basin, bidé,
kitchen and single levers basin and bidé.

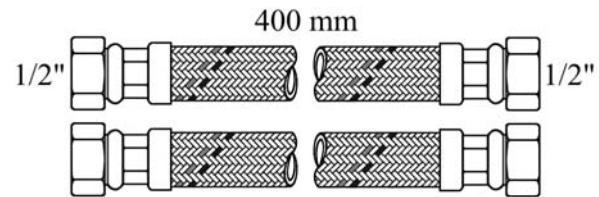

014695.OAR.99 —

Para juego de bañera de 3 agujeros
For 3 hole bath set



015942.OAR.99 —

Para juego de bañera de 5 agujeros
For 5 hole bath set

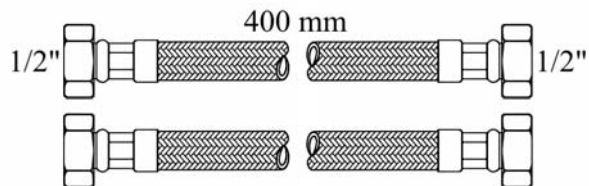

015783.OAR.99 —

Para juegos de lavabo de 3 agujeros con racor-enlace
For 3 hole basin set with "T" assembly

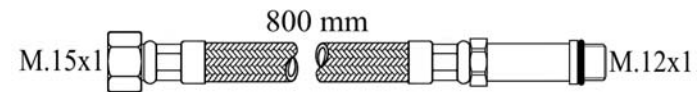

015941.OAR.99 —

Para juego de bañera de 2 agujeros
For 2 hole bath set

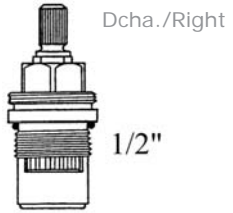

014684.0AR.99



014685.0AR.99

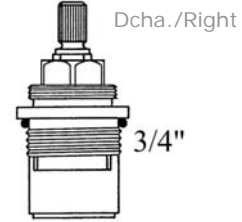

014719.0AR.99

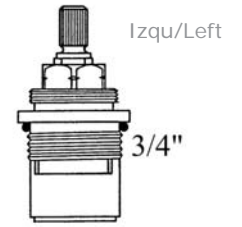

014720.0AR.99

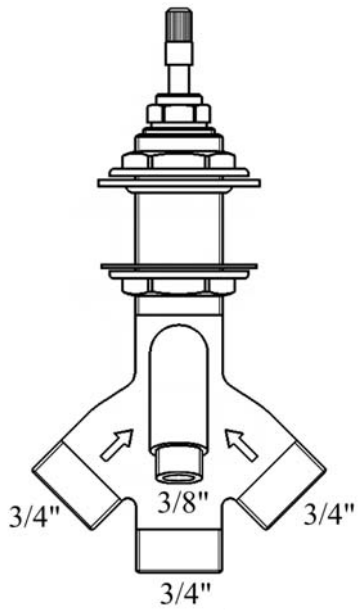

089035.0AR.99

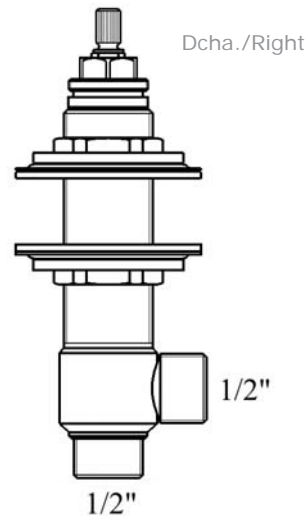

089020.0AR.99

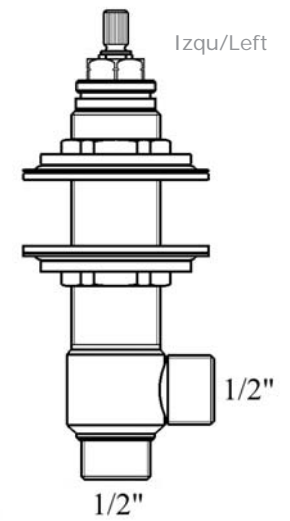

089021.0AR.99

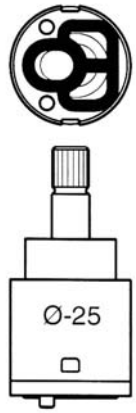

015959.0AR.99 ———

para / for : 039243.A00
 039244.A00
 039263.A00
 039443.000
 039444.000
 039463.000

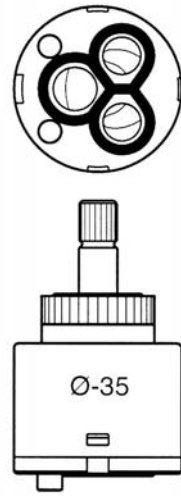

015958.0AR.99 ———

para / for : 039257.A00
 039457.000

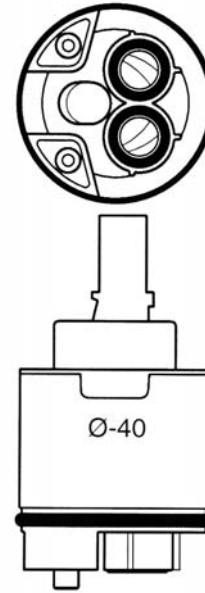

015063.0AR.99 ———

para / for : 038103.000
 038103.N00
 038123.000
 038123.N00

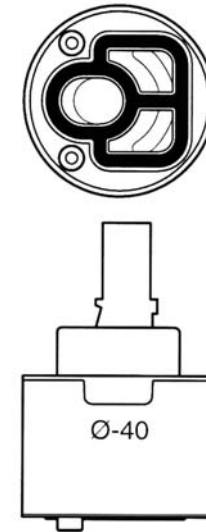

015084.0AR.99 ———

para / for : 038112.000
 038112.N00
 038113.000
 038113.N00

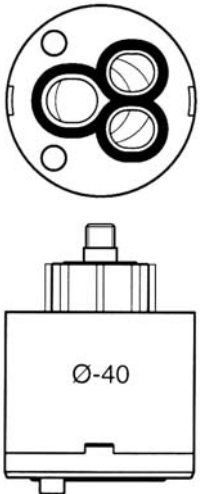

015956.0AR.99 ———

para / for : 058012.000
 058013.000
 058112.F00
 058112.FN0
 058113.F00
 058113.FN0

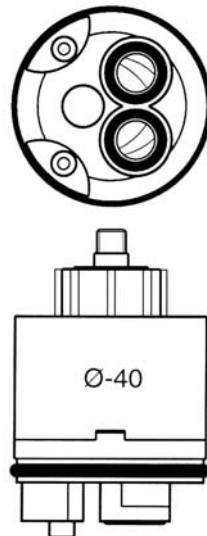

015957.0AR.99 ———

para / for : 058003.000
 058023.000
 058103.F00
 058103.FN0
 058123.F00
 058123.FN0



015960.0AR.99 ———

para / for : 033203.000
 033203.N00
 033223.000
 033223.N00
 033403.C00
 033423.C00

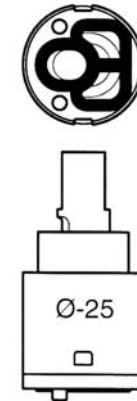

015900.0AR.99 ———

para / for : 045003.000
 045003.L00
 045023.000

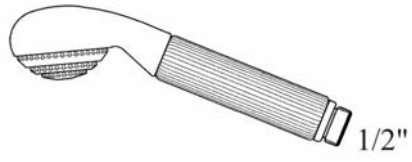

—— 015050.0AR.00
 .50
 .62

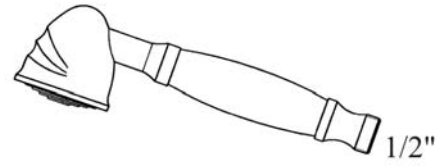

—— 015056.0AR.00
 .50
 .62
 .71
 .73

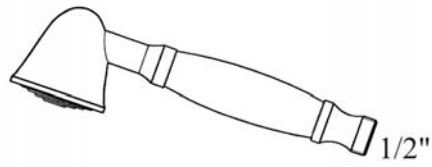

—— 015056.BAR.50
 .62

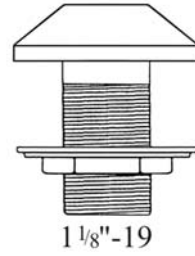

—— 015054.0AR.00
 .50
 .62
 .71
 .73

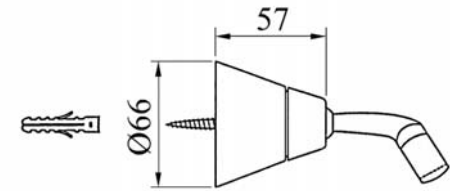

—— 035066.000.00
 .30
 .50
 .62
 .71
 .73

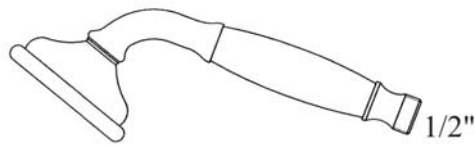

—— 030157.0AR.00
 .30
 .50

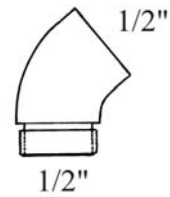

—— 015051.0AR.00
 .50
 .62
 .71
 .73

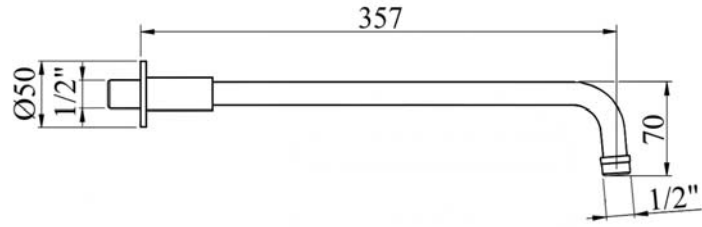

015950.0AR.00 —
 .30
 .50

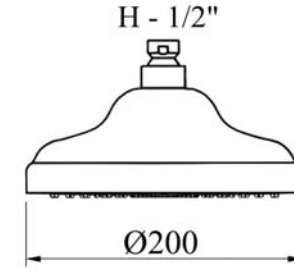

015946.0AR.00 —
 .30
 .50

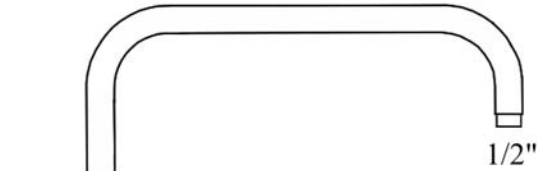
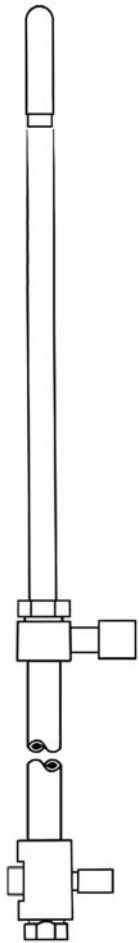

Ø20

1/2"

Ø24

H - 3/4"

015945.0AR.00 —
 .30
 .50

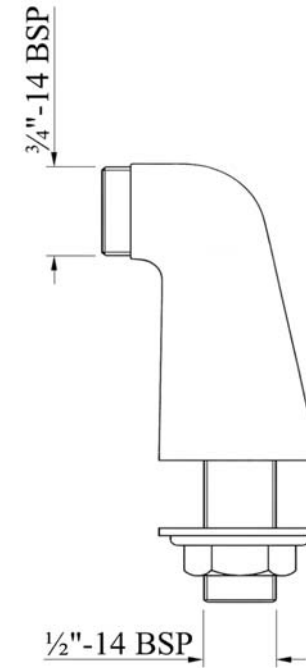

3/4" - 14 BSP

1/2" - 14 BSP

035055.000.00 —
 .30
 .50

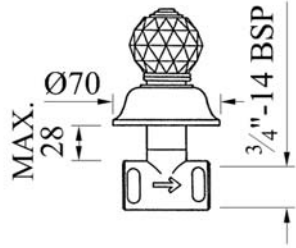

— 037138.000 .00
 .50
 .62

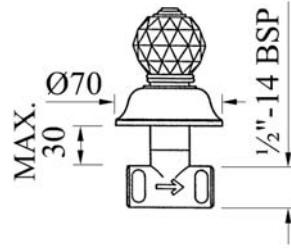

— 037137.000 .00
 .50
 .62

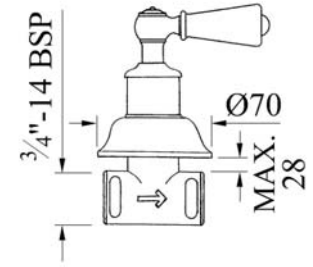

— 035038.M00 .00
 .30
 .50

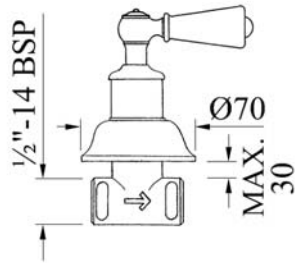

— 035037.M00 .00
 .30
 .50

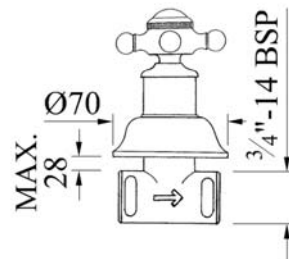

— 035038.000 .00
 .30
 .50

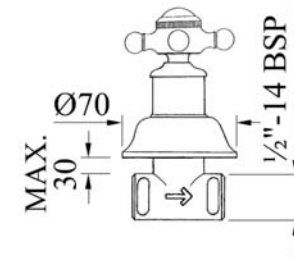

— 035037.000 .00
 .30
 .50

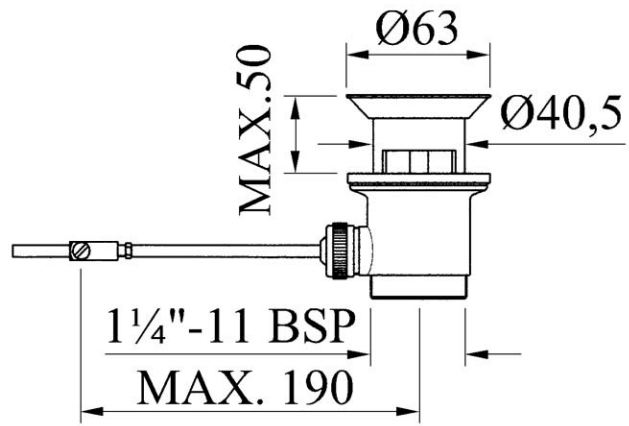

- 035050.000 .00
- .30
- .50
- .62
- .71
- .73

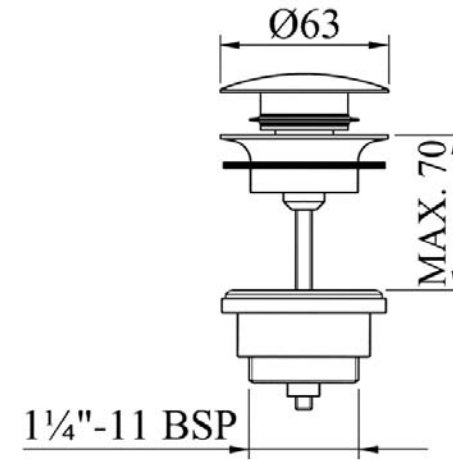

- 035049.000 .00
- .50
- .71

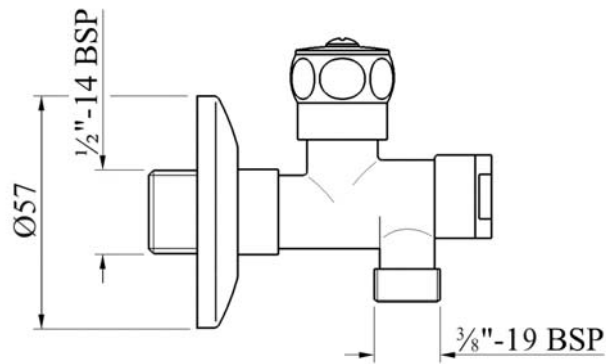

- 035053.000 .00
- .30
- .50